



**WIN A WITNESS 9mm —
See Page 18**

**INSIDE HANOI'S SECRET ARCHIVES:
POW Mysteries Solved**

SOLDIER OF FORTUNE

**SOF With
Russian
Spetsnaz
in Chechnya**

**“... NECESSARY TO THE
SECURITY OF A FREE STATE ...”**

Modern Minutemen Aim To Keep America Free

**SOLDIER OF FORTUNE
April 1995**



APRIL 1995 48493
0 71896 48493 9 04
CAN. \$4.75 UK £2.60 U.S. \$3.95

**THE FAST AND THE DEAD:
Elite Marines Still
Firing-Up Somalis**

SOF 20th Anniversary



GREAT GUNS GIVEAWAY!

**GREAT
PRIZES!***
**GREAT SAVINGS
ON SOF ONLY**
\$26.20

Celebrate all
year long -



*no purchase necessary to win
credit card orders call
1-800-877-5207

- 1 year @ \$26.20
 2 year @ \$50.00
 sweepstakes only
 bill me later

name _____

address _____

city _____

state _____ zip _____

day phone # _____

Offer good in the U.S. and possessions including APO, FPO addresses, for a limited time only. Canada add \$10.00 per year.
(Includes GST #R128476249) foreign add \$21.00/yr. Money Back Guarantee

NIGHT VISION

Lowest Prices! Largest Selection! Best Warranty!

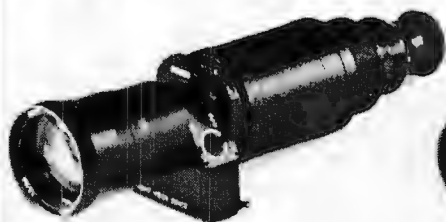

NIGHTTHUNDER™

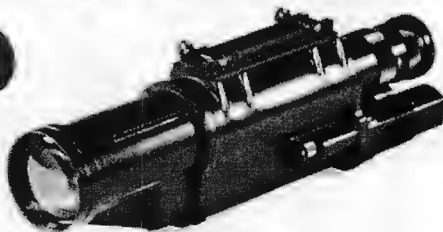

NIGHTFIGHTER™

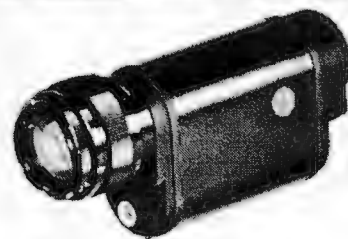

PANTHER™

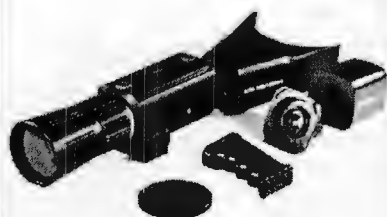

**NIGHTTRACKER
SYSTEM II™**

- Full one year in house Warranty
- Optional second year Warranty available
- I, II & IIIrd Generation Night Vision products
- Catalog available
- Call for our monthly special offers
- Largest U.S. supplier of Night Vision and daytime optics for every application
- Major Credit Cards accepted

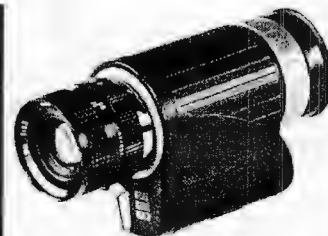

NIGHTPHANTOM™

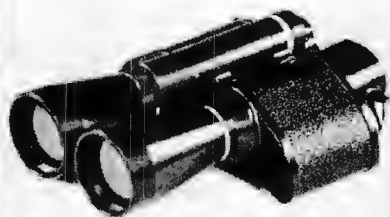

NIGHTSEEKER I/II/III™

VISION AT NIGHT!
as low as
\$285



NIGHTVIEWER™

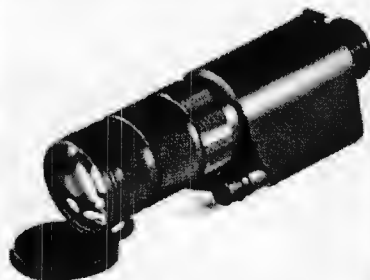

RETRON MOI™



AN/PVS-7

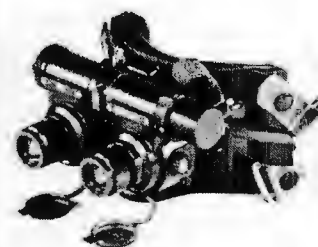

NIGHTCHASER™



NIGHTVOYAGER II™



NIGHTBREAKER™

COMMAND GUIDANCE

MAGAZINE STAFF

Editor/Publisher Robert K. Brown
Associate Publisher T. "Lefty" Wilson
Executive Editor Tom Slizewski
Senior Editor Don McLean
Technical Editor Peter G. Kokalis
Features Editor Dwight Swift
Columns Editor Lynne Robertson
Production Director Kathleen Allard
Art Director Mary Scrimgeour Jenkins
Assistant Art Director Kristine Anderson
Special Projects Alexander McColl

Foreign Correspondents

Chief Foreign Correspondent: Dr. Tom Marks
Senior Foreign Correspondents:
Steve Salisbury • Rob Krott • Peter Douglas •
Chuck Fremont • Morgan Tanner •
Jack Thompson • Maj. Mike Williams •
Mike Winchester • Dale B. Cooper

Contributing Editors

Vietnam Veterans Affairs Col. Chuck Allen •
Military History William Brooks — William H. Northacker • Unconventional Operations Brig. Gen. Heine Aderholt — James P. Monaghan — Maj. Robert MacKenzie • Paramedic Operations Dr. John Peters • Explosives/Demolitions John Donovan • Aviation Dana Drenkowski • Africa Al Venter • Outdoor Affairs Galen Geer • Latin America Hugo Hartenstein • Gun Rights Paul Danish • Skydiving Kitty Baran

Financial Director Gregg Peterson
Business Manager Sharon Windsor
Bookkeeper Carole Hayden
Circulation Manager Carrie Karlson
Consultant Zada Johnson
Advertising Manager/Assistant
Convention Director Dianne McLeod
Receptionist Helena Oberg

For editorial/advertising, call 303-449-3750.
Subscription inquiries, call 1-800-877-5207.
For list rental contact: Dave Power, Antigone Associates 215-357-9267.

In Memoriam

Craig Nunn — Art Director
Lance Motley — Foreign Correspondent
Barry Sadler — Contributing Editor

NOTICE: SOLDIER OF FORTUNE Magazine is a magazine of national and international distribution. There may be products in the magazine of which sale, possession or interstate transportation may be restricted, prohibited or subject to special licensing requirements in your state. Purchasers should consult local law enforcement authorities in their area. All data in this publication, technical or otherwise, is based upon personal experience or individuals using specific tools, products, equipment and components under particular conditions and circumstances, some of which may not be reported in the article and which Soldier Of Fortune has not otherwise verified. Soldier Of Fortune, its agents, officers and employees disclaim any responsibility for all liability, injuries or damages.

Best Defense is a Good Defense

by Robert K. Brown

From time to time there are suggestions that the NRA and other gun-rights groups are too much on the defensive, trying to prevent the passage of anti-gun laws, and not enough on the offensive, pushing proposals that will shift the balance away from the criminal and in favor of the law-abiding citizen.

An incident in early December 1994 in Denver illustrates just how far things have gotten out of hand.

State Sen.-elect Pat Pascoe, a shrill anti-gunner, saw two young men attempting to break into her house. She sought help from her next-door neighbor, Robert

Coleman, a Vietnam vet and former San Diego cop. He retrieved his gun and foiled the break-in. As the two thugs took to their heels, they shouted at Coleman that they'd be back to get him. Coleman fired on the fleeing pair and hit one in the spine at 100 yards.

Now he is facing felony charges for first-degree assault, which carries a maximum sentence of 32 years in prison. This is justice?

The gun-rights constituency in Colorado, mainly the Firearms Coalition of Colorado (FCC), with SOF's enthusiastic support, is doing two things about this: first, collecting money to help pay for the defense of this outrageous persecution of a brave, law-abiding citizen.

Second, the FCC and pro-gun legislators are supporting proposals in the Colorado Legislature that expand the rights of ordinary citizens to use deadly force against a per-

son who is using, or appears to be about to use, physical force against an occupant of a dwelling, business establishment or motor vehicle; while committing or attempting to commit burglary, criminal mischief or criminal trespass; and/or against a person who reasonably appears to be committing or trying to commit various violent felonies. Another proposal would bar any civil action for damages sustained by the culprit during the commission of a felony or in flight from the scene.

When, and if, enacted, these two laws, along with a general concealed carry

law, which is also in the mill here, should go a long way toward making the streets safer for the law-abiding without greatly increasing the number of felons being supported in state prisons.

This is not just local news. The real reason for putting this in SOF is to get the word out to gun-rights groups across the country, so they can take similar action in their state legislatures. We are happy to send copies of the actual texts of these proposals to recognized gun-rights groups; write us on your group letterhead and enclose an SASE.

And, if you can, send a check to the Rob Coleman Defense Fund Trust. Do it today. ☞

Rob Coleman Defense Fund
Colorado State Bank of Denver
Attention: Account Services
1600 Broadway
Denver, CO 80202



SOLDIER OF FORTUNE (USPS 525-810, ISSN 0145-6784) is published monthly by SOLDIER OF FORTUNE Inc., 5735 Arapahoe Ave., Boulder CO 80303-1340. Second-Class Postage is paid at Boulder CO and additional mailing offices. POSTMASTER: Send address changes to SOLDIER OF FORTUNE, Subscription Department, POB 348, MT Morris IL 61054-0348 or call 1-800-877-5207. U.S. and APO-FPO subscription rate for twelve monthly issues: \$28.00. Canada add \$10.00/yr. additional postage (includes GST tax registration number: R128476249). All other countries add \$21.00 U.S. FUNDS ONLY. Single Issue Price — U.S., \$3.95; United Kingdom, £2.60; Canada, \$4.75. PRINTED IN THE U.S.A.

CONTRIBUTORS: Manuscripts, photographs or drawings are submitted at the contributor's own risk. Material should be mailed to Articles Editor, SOLDIER OF FORTUNE, P.O. Box 693, Boulder, CO 80306, and cannot be returned unless accompanied by sufficient postage. Any material accepted is subject to such revision as is necessary to meet the editorial requirements of SOF. All manuscripts must be typed double-spaced. All photographs should be credited and be accurately identified. Payment will be made at rates current at time of publication. Editorial office phone number is 303-449-3750.

Copyright © 1995 by SOLDIER OF FORTUNE Magazine Inc. All Rights Reserved.



The FAST and the Dead — page 54

Photo: courtesy Dale B. Cooper

FEATURES

SOF ON THE GROUND IN CHECHNYA

Mark H. Milstein

Our crazy foreign correspondent hitches a ride on army supply convoy into Grozny to see if the once mighty Russian Bear is really getting bloodied at the hands of Chechen civilians. 32

PROFESSIONAL HOLY WARRIORS

Mike Winchester

Afghan mercs are flooding into Jammu and Kashmir to aid Muslim guerrillas, and 400,000 Indian troops have been deployed to keep insurgency from becoming next great jihad. Has expanding Islamic

fanaticism met its match in India? 36

ANSWERS FOR ADVANCED TACTICAL PROBLEMS

Peter G. Kokalis

Learn the "school solution" to today's social problems with a pilgrimage to the armed professional's mecca — and earn a Gunsite Ph.D. 40

POLITICS OVER PRINCIPLE

David McElroy

"Damn the evidence, full scheme ahead," is the FBI's battle cry in an effort to get its man — guilty or not. The result: Tom Posey loses his liberty

for working against the will of Congress and providing clothing to contra refugees. 44

INSIDE HANOI'S SECRET ARCHIVES

F.C. Brown

With more intrigue than Ian Fleming could fabricate, Malcolm McConnell's new book delves into covert communist records and solves several decades-old POW/MIA mysteries. 46

"...NECESSARY TO THE SECURITY OF A FREE STATE..."

Mike Williams

Across America patriots are organizing against an



Holy Warriors — page 36
Photo: Mike Winchester



SOF in Chechnya — page 32

Photo: Mark H. Milstein

increasingly dangerous government intent on robbing people of their rights. These modern minutemen aim to keep the Constitution the supreme law of the land. **48**

THE FAST AND THE DEAD

Dale B. Cooper
Last leathernecks left in Somalia run the gauntlet in Mogadishu for U.S. Liaison Office. Using firepower and fire discipline they manage to stay alive long enough to turn out the lights. **54**

KATONA GETS HIS GUNS

James L. Pate
Republicans control the Congress; hearings are planned on federal law enforcement abuses; and

the ATF returns Katona's guns — did hell just freeze over? **58**

FM 90-10-1 NATIONAL POLICE FORCE TRAINING MANUAL?

SOF Staff
What is the government trying to hide by limiting distribution of the updated manual on urban warfare? **60**

SPIKING A LOOSE CANNON

Jim Morris
SpecOps warrior Keith Idema has his day in court and finds that infiltrating secret Soviet training bases is easy compared to dealing with the American justice system. **61**



COLUMNS

- Command Guidance 3**
- Bulletin Board 6**
BATF Waco Memorial
- FLAK 12**
Let Voters Shoot-down Clinton
- World SitRep 16**
- Slick Willie Watch 19**
Brady Bashing
- Second Amendment O.P. 25**
Doctors, Lawyers, Guns & Money
- Full Auto 28**
Fatal Subtraction
- Combat Weaponcraft 30**
PC Assault Rifle
- Supply Locker 88**
- Classified 93**
- Advertisers Index 98**

COVER

Just as their ancestors mustered with muskets against a merciless monarchy, the Michigan Militia organizes and trains to secure the Constitution against another Goliath — a government that seems to have turned on its people. The reasons behind the rise of militias and their legality are chronicled beginning on page 48. Photo: courtesy James McQuaid



BULLETIN BOARD

RULES BROKEN, CONSTITUTION VIOLATED, RESPONSIBLE PARTIES PROMOTED...

A confidential 542-page Justice Department study of the debacle at the Randy Weaver standoff in Idaho three years ago has come down hard on its own — on paper, at least. Prepared by a 24-member investigative team reporting to the Office of Professional Responsibility (DOJ's internal disciplinary unit), the report characterized the whole chain of events leading to the 10-day standoff as a chaotic sequence of events that nearly spun out of control as the honchos in Washington stumbled through a series of mistakes and misjudgments, at one point changing the rules of engagement and ordering agents to shoot at any armed adults if they had a clear shot. Those shot, however, included a 14-year old boy and his unarmed mother.

The report stated, "Certain portions of the rules of engagement not only departed from the FBI's standard deadly force policy but also contravened the Constitution of the United States." The investigating agents also "found these rules to be imprecise and believe that they may have created an atmosphere that encouraged the use of deadly force, thereby having the effect of contributing to an



Yes, Martha, there *are* black choppers! And your neighborhood militia can have its very own Mini-500 for only \$26,500 in kit form. Taking "approximately one week to assemble," the Mini-500 is made by Revolution Helicopter Corporation, Dept. SOF, 1905 W. Jesse James Road, Excelsior Springs, MO 64024. Info packet is \$15, video \$30 — or call Gus Lanz; phone: 816-637-2800 for more info. As the manufacturer notes, "It provides a reliable, but inexpensive means of airpower that any friendly country could afford many of." Photo: courtesy Revolution Helicopter Corporation

unintentional death."

But the highly critical nature of the official report is at odds with actions at the FBI. Although senior officials are criticized for violating their own policy and the U.S. Constitution in a manner that cost innocent lives,

Larry A. Potts, who had overall responsibility for the operation, was recently promoted by Director Louis Freeh to be his chief deputy. It has also been announced that the FBI will not punish sniper Lon Horiuchi for killing Vicki Weaver.

Guthrie may have overheard conversations regarding drug and weapons deals. Guthrie lived and worked at an auto detailing shop owned by Vena. Authorities determined Guthrie was killed by two shotgun blasts in Cheyenne; then his body was taken to Weld County, Colorado, and dumped.

The BATF office in Seattle stated in a release that the two suspects were BATF informants, but that no criminal cases had been developed using the information they provided.

A JAPANESE GERM WARFARE STAMP?

The *China Daily* reports that Sha Dongxun, a researcher with the Guangdong Academy of Social Sciences, has found and identified an-



The media gets it ackbassward again: Here's a background graphic CNN uses when discussing news relating to terrorism — an M16-type weapon, with its 30-round magazine stuck in *upside-down and backward!* Photo: Ken Carter

TALES FROM THE JOINT

by K. Hawkeye Gross

It's every man's worst nightmare: being removed from family and friends to a world of concrete, steel bars and gun towers. A world inhabited by rapists, armed robbers, gangsters and murderers . . . the world of a maximum-security prison. *Tales from the Joint* is the story of a white, middle-class, college-educated flyboy-turned-drug-smuggler's incarceration inside a Florida state prison. Most people who've never been locked up believe Hollywood's depiction of prison life as a subculture of violent, psychotic, throat-slitting, gang-raping deviates. But not all inmates are tattooed, muscle-bound psychopaths looking to stick their shanks into someone's gut. K. Hawkeye Gross introduces you to the real people he met while serving his time, including Ted Bundy, Nate the Pimp, Leroy the Jitterbug, Stuart the Stud, Dangerous Jack, Judge Joe Peel, Little Man Charles . . . and a host of other Hell's Angels, Outlaws, rednecks, Aryan Brothers, Mafiosos, gang bangers, jailhouse lawyers and dress-up boys. His gritty descriptions and dialogue capture the day-to-day emotional swings, fear, brutality and humor of life in the "big house." 5 1/2 x 8 1/2, hardcover, 280 pp. **\$24.95**

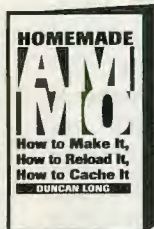
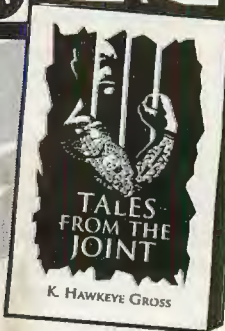

HOMEMADE AMMO
How to Make It, How to Reload it, How to Cache It
by *Duncan Long*

Almost any handyman with a drill can produce a gun in a few weeks, but the same is not true for ammo. *Homemade Ammo* provides all the technical know-how you need to manufacture your own rifle, pistol or SMG ammo from scratch. Includes chapters on primers, powders, brass, bullets, cleaning, caching and more. 5 1/2 x 8 1/2, softcover, illus., 104 pp. **\$14.00**



THE WHOLE SPY CATALOG
by *Lee Lapin*

The *Whole Spy Catalog* shows you exactly how to hire an ex-KGB agent, order a photo of anyone on earth anytime during the last 20 years, get an instant background check on anyone, open a door from 100 feet away, subscribe to an in-house FBI newsletter, order and install the latest electronic surveillance gear and many more tricks to trace, track, surveil and investigate anyone or anything. 8 1/2 x 11, softcover, photos, illus., 430 pp. **\$44.95**



ULTIMATE SNIPER: THE VIDEO
with *John Plaster* & *Carlos Hathcock*
Learn the art of sniping from two masters. Maj. John Plaster instructs you in all areas of sniping fieldcraft, marksmanship and tactics, and famed USMC sniper Carlos Hathcock recounts some of the field-tested tactics he used to rack up 93 confirmed kills in Vietnam. Covers optics, weapons, shooting drills, camo, stalking, hides, countersniping, range and wind estimation and more. Color, approx. 90 min., VHS only. **\$59.95**



WAR STORY
by *Jim Morris*

Paladin is proud to reissue what is considered to be one of the best accounts ever written on U.S. Army Special Forces in Vietnam. SF veteran Jim Morris describes the war of stealth fought by his troops and their Montagnard allies against the NVA. "If you want to know how it really was in the Special Forces in Vietnam, this is the book to read," says Gen. Jack Singlaub, USA (Ret.). 5 1/2 x 8 1/2, hardcover, 308 pp. **\$29.95**

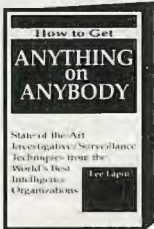

HOW TO GET ANYTHING ON ANYBODY
by *Lee Lapin*

Get the goods on others with this encyclopedia of advanced investigative and surveillance techniques. Here are expert ways to secretly bug any target! Info on lock-pick technology, how polygraphs and voice lie detectors can be tricked and much more, including more than 100 sources for spy equipment. 8 1/2 x 11, softcover, illus., 272 pp. **\$30.00**



THE ULTIMATE SNIPER
An Advanced Training Manual for Military and Police Snipers
by *Maj. John L. Plaster, USA (Ret.)*

This highly readable and extremely valuable training book covers the practical, field-tested details of sniping's three great skill areas — marksmanship, fieldcraft and tactics. Rifles, scopes, ballistics, target detection, stalking, hides, camo, countersniping, special ops, police vs. military and much more. 8 1/2 x 11, softcover, photos, illus. 464 pp. **\$39.95**

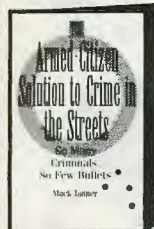

THE ARMED-CITIZEN SOLUTION TO CRIME IN THE STREETS
So Many Criminals, So Few Bullets
by *Mack Tanner*

Crime can only be stopped in America if we take responsibility for our own safety. Arming and organizing volunteers into self-defense alliances has proven to be the most effective way of halting crime and making neighborhoods safe places to live, work and raise kids. Find out how groups all over America have done this. 5 1/2 x 8 1/2, softcover, 200 pp. **\$12.00**



CREDIT SECRETS
How to Erase Bad Credit
by *Bob Hammond*

Solve your financial problems once and for all! These proven methods show how to eliminate debts and establish a perfect credit rating. Discover the inside tricks used by lawyers and professional credit consultants with this easy-to-follow program. 5 1/2 x 8 1/2, softcover, 80 pp. **\$14.00**



THE LONG-RANGE WAR
Sniping in Vietnam
by *Peter R. Senich*

This is the most complete report ever on the U.S. military's unprecedented use of snipers and sniping equipment in Vietnam. Highlighted are the fielding of the XM21 sniper rifle and the Adjustable Ranging Telescope, plus the application of sound suppression devices and special carbines so typical of the unconventional warfare in SE Asia. 8 1/2 x 11, hardcover, photos, illus., 280 pp. **\$39.95**

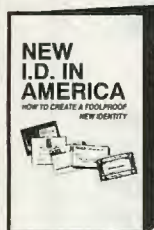

NEW I.D. IN AMERICA
by *Anonymous*

Want one more chance at life with a "clean slate"? Trade in your old identity for a new start. Here is a step-by-step guide to creating a totally new you — with a birth certificate, passport, driver's license, Social Security number — all you need for breaking with your past. 5 1/2 x 8 1/2, softcover, illus., 120 pp. **\$17.00**



SEAL SNIPER TRAINING PROGRAM

This highly sought manual — until now available only to this elite cadre of specially trained SEALs — contains the complete program by which SEAL snipers train, equip and operate. Included are precise instructions and exclusive, clear photos for target sighting, aiming, trigger control, aircraft takedown, range estimation, helo insertion, ship boarding, stalking, marksmanship and more. 8 1/2 x 11, softcover, photos, illus. 320 pp. **\$30.00**

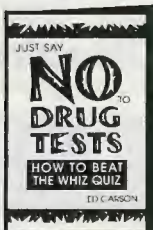

JUST SAY NO TO DRUG TESTS
How to Beat the Whiz Quiz
by *Ed Carson*

Urinalysis is a blatant violation of human freedom and dignity, and now you can fight back! Ed Carson, who handled drug testing for a large U.S. military base, reveals how the tests are done and how to beat them. He did it successfully for eight years using the exact methods outlined in this book. Find out how to preserve your life-style and keep your job. 5 1/2 x 8 1/2, softcover, 48 pp. **\$12.00**

OTHER FASCINATING TITLES

POLICE RIFLES:
SELECTING THE RIGHT RIFLE FOR STREET PATROL AND SPECIAL TACTICAL SITUATIONS\$30.00
HOME WORKSHOP
PROTOTYPE FIREARMS\$25.00
EXECUTIVE PROTECTION:
A PROFESSIONAL'S GUIDE TO BODYGUARDING ..\$12.00
WILDERNESS WAYFINDING.....\$15.00
U. S. MARINE CORPS
SNIPING: FMFM1-3B\$14.95
SURVIVALIST'S
MEDICINE CHEST\$10.00

THE STONER MACHINE GUN:
A NAVY SEAL REMEMBERS (VIDEO)\$29.95
STONER 63 WEAPONS SYSTEM.....\$10.00
DESERT STORM MAP\$15.00
AN INFANTRYMAN'S GUIDE TO COMBAT IN BUILT-UP AREAS\$29.00
PEPPER SPRAYS: PRACTICAL SELF-DEFENSE FOR ANYONE, ANYWHERE...\$15.00
GET EVEN 2.....\$19.95
COMPLETE AR15/M16 SOURCEBOOK.....\$35.00

MONEY-BACK GUARANTEE — DEALER INQUIRIES INVITED

Paladin Press • P.O. Box 1307 • Boulder, CO 80306 • (303)443-7250
FAX (303)442-8741

Videotapes are nonreturnable. Damaged tapes will be replaced.



PALADIN PRESS
P.O. BOX 1307-5DS
BOULDER, CO 80306



CREDIT CARD ORDERS CALL TOLL FREE
1-800-392-2400

Call 24 hours a day, 7 days a week. Send \$2.00 for a 64-page CATALOG of over 600 titles (free with order).

PLEASE SEND ME THE FOLLOWING TITLES:

RESPONSE CODE: 5DS

NAME _____
ADDRESS _____
CITY _____
STATE _____ ZIP _____

VISA MASTERCARD
 DISCOVER CHECK / MONEY ORDER
CARD# _____
EXP. _____

SUBTOTAL _____

PLEASE INCLUDE \$ 4.00
POSTAGE & HANDLING

TOTAL _____

other Japanese army laboratory where thousands of Chinese were killed in bacteriological experiments during World War II. Sha identified the laboratory in southern Guangdong Province, which she said was founded in 1939 by Japan's "fourth war-fare army" in 1939, designated as 4164, at the former medical college of Zhongshan University in the provincial capital, Guangzhou.

The program by Bo8609 included planting various potentially fatal, infectious diseases in refugees from Hong Kong and surrounding Guangdong Province to study the effects and weigh their potential for use in germ warfare. Sha reports between 3,000 and possibly as many as 20,000 people were killed in the experiments. "The finding will help unmask the inten-

tionally covered facts of that period of history," Sha noted.

NAFTA CARBINES

Although throughout her history Mexico has made it a point to not accept military aid per se from north of the border, it appears she may have succumbed to a mutuality of interest and accepted some 48,000 .30 M1 carbines from Uncle Sam. It is believed they will be issued to rural or reserve militia/police forces to aid in fighting Zapatista or other potential insurgents. Since the DCM will never get any more, we suppose this is at least better than cutting them up.

WACO-RELATED

An interesting tidbit from the September 1994 issue of *The Agent*, official publication of the National Association of

Treasury Agents: *TEXAS — The first Waco-related suspension has been given to an ATF management official.*

No, that's not a reference to Phillip J. Chojnacki and Charles D. Sarabyn, the two BATF scoundrels who headed up the biggest disaster in federal law enforcement history.

It refers to Special Agent Chris Heart, a group supervisor with 25 years' experience, who was suspended for two days without pay for visiting the Mount Carmel ruins, site of the Waco massacre, on the same day in May 1993 that raid participants revisited the scene "for therapeutic purposes." *The Agent* noted, "The sanctioned supervisor had not been a participant," and "visits were supposed to be restricted to raid participants."

Heart was punished

despite his claim that he got special permission for the visit — and the fact that "numerous other unauthorized ATF personnel were on the site that same day [and] none were punished." So why was Heart singled out? Probably because he had testified at a grievance hearing on behalf of a young agent who had been fired in an unrelated (and no doubt far less serious) matter.

And what of Chojnacki and Sarabyn? *SOF* reported their being fired on 26 October for gross negligence, incompetence and falsifying official documents related to the Waco disaster. It must have been a Halloween trick, because on Christmas Eve, they got a gift that made us want to puke in our stockings. These crumbs got their jobs back, along with full back

"Special Purchase Allows Price Breakthrough"

**Catalog \$4⁰⁰
Product Video \$10⁰⁰**

The Leader In Technology for Scoping, Sighting, Photographing and Videotaping In The Dark

NIGHT VISION WEAPON SIGHTS

I GEN.
AN/PVS-2B Weapon Sight



II & III GEN.*
**AN/PVS-4
Weapon Sight**
\$2850⁰⁰

* Photo/Video Adapter Included
* New with Excellent Cond. Intensifier
* III Gen. POR

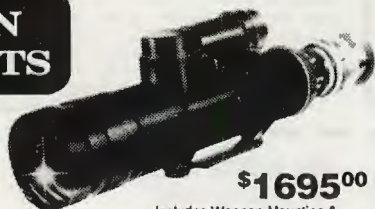

\$1695⁰⁰

* Includes Weapon Mounting &
Photo/Video Adapter.

POCKETSCOPE

II & III GEN.*
NIGHT EXPLORER

* Photo/Video Adapter Included
* New with Excellent Cond. Intensifier
* A Choice of Two Lenses from
1X, 2X or 3X * III Gen. P.O.R.

Grade 1 **\$1550⁰⁰**
Grade 2 **\$1350⁰⁰**



NIGHT VISION GOGGLES

II GEN.
NVG-500

Starlight Goggles

* Includes: Cold Weather Heaters
* Excellent Cond.

Grade 1 **\$2450⁰⁰**
Grade 2 **\$2250⁰⁰**

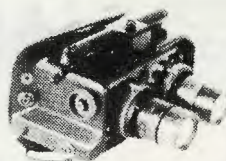

II GEN.
SC/PVS-700

Mono-Tube Goggle

\$2295⁰⁰

* Excellent Cond.
* 2X & 3X Lens Included

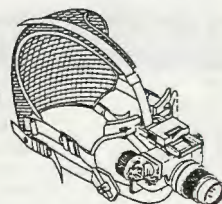

III GEN.
**AN/PVS-7B
Mono-Tube Goggle**

* 3X Add-on Available
\$4500⁰⁰
(New - Standard)

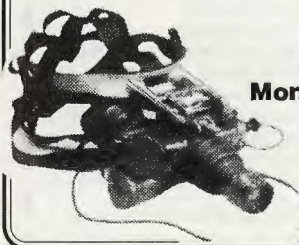

We do not offer parts, mounts, or accessories separately. Support is reserved for our customers only.

STANO Components

P.O. Box 2048 • Carson City, Nevada 89702 • (702) 246-5281 / (702) 246-5283 / Fax (702) 246-5211

pay and benefits — this after eight months of administrative leave that amounted to a paid vacation. According to federal sources, Chojnacki and Sarabyn threatened to name names about what “really” happened. Although technically demoted, each will be receiving similar pay as when they were fired, and the Treasury Department will foot the bill for their lawyers. Chojnacki, a 24-year ATF veteran, is now the ATF liaison to the U.S. Customs Service in Houston. Sarabyn, with ATF for 18 years, will be chief of the visual information branch at ATF headquarters in Washington. We can only hope that when they go home to their kennels each night, their mothers bite them.

— James L. Pate

MONUMENTAL HYPOCRISY

This item is reminiscent of the guy down in Phoenix a few years back

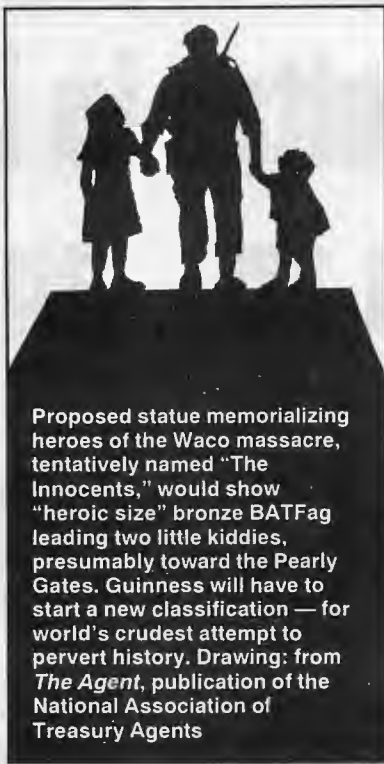

Proposed statue memorializing heroes of the Waco massacre, tentatively named “The Innocents,” would show “heroic size” bronze BATFag leading two little kiddies, presumably toward the Pearly Gates. Guinness will have to start a new classification — for world’s crudest attempt to pervert history. Drawing: from *The Agent*, publication of the National Association of Treasury Agents

who tried to raise funds for a memorial to Hanoi Jane Fonda and other Vietnam War protesters. But no doubt readers will get that special, warm, fuzzy feeling when they learn that the National Association of Treasury Agents (NATA) has formed a committee to dedicate a large bronze statue memorializing the four ATF agents and scores of children killed as a result of the Waco massacre. Its working title? “The Innocents.” One proposal would have “a heroic-size” ATF agent in SWAT gear, his machine gun slung over his shoulder, holding the hands of a little girl and a little boy. Apparently, there is dissension in the ranks. One letter to the editor of NATA’s newsletter decr

ing to erect a monument in Waco to the BATF officers who died there along with the children they terrorize and murder ... You should name your monument ‘The Baby Butchers.’”

The statue “is not intended. ... date the decisions’ feasibility of any ATF supervisory official,” the NATA newsletter notes. “... committee is seeking national concepts as well.” Ideas should be directed to the committee chairperson, Ms. Donna Miller, a special agent with the U.S. Secret Service, at (202) 828-1960.

— James L. Pate

DEA AGENT CONVICTED

A Douglas County, Colorado, jury has convicted DEA Special Agent Mark Dietze of menacing

Continued on page 86

EXTRAORDINARY SURVEILLANCE AND INVESTIGATION AIDS

IT'S FINALLY HERE!

After two years of research Lee Lapin's THE WHOLE SPY CATALOG IS OUT. Lee traveled over 30,000 miles interviewing top spies, information procurers, detectives and the world's best electronic surveillance experts to make THE WHOLE SPY CATALOG the only book of its kind EVER!

The perfect companion guide to the HOW TO GET ANYTHING ON ANYBODY series this 440 page, large format, hands-on encyclopedia will stun you with professional secrets, tricks of the trade, “inside” phone numbers, ordering information and cutting edge techniques to trace, track, surveil and investigate anyone or anything...

How To Locate And Research Anyone including tear out tax forms for your immediate use. The \$5.00 phone call that finds 90% of the population. A real time chart that begins with a name and ends with a complete personal history — *How to do it yourself, step-by-step...* — **How To Locate And Research Anyone's Assets** — **How To Locate and Bug Anyone**. Electronic Surveillance tests/sources of the latest and greatest audio bugs and telephone taps. A source where you can buy actual KGB surveillance equipment — **How To Locate and Tap Any Phone**. A guide for the morally blind. — **Video Surveillance** What's available and where to get real deals on state-of-the-art cameras, lenses and transmission systems — **Counter Measures** the latest gear, how good, where. — **Night Vision** don't envy your cat, get even. *Survive the jungle*, the truth about the Russian invasion; what works, what doesn't, the traps and pitfalls plus the best sources — **Plus** How to order a high resolution aerial or satellite photograph of anywhere on earth over the past 30 years — Best book sources from the CIA to changing your ID — Private detective schools, courses, sources. — Best newsletters, courses and associations — The latest B & E tricks of the trade.

THE WHOLE SPY CATALOG—\$44.95



CONGRATULATIONS!

You've just found the best source for night vision scopes in the, well, hell, maybe the world. The American made LEOPARD is a compact, rugged, handheld viewer—the smallest unit of its kind in the entire world. Utilizing 3rd generation technology, the LEOPARD works like magic in adverse weather and moonless nights. The intensifier tube and optics are identical to that of the Anvis Aviator's Goggles (remember Desert Storm?). The LEOPARD takes common C-mount camera lenses, allowing almost any front-end configuration, (comes with 1X lens), including relays, doublers, and zooms.



Radical (optional) ocular relay allows direct operation with SLR and video cameras. Optional adapter allows use as single eye goggle. Even has a built-in IR illuminator and threaded rings on both ends... Optional Weaver scope mount, or an invisible laser that throws an IR dot on your target that you can see and aim through the LEOPARD.

We've spent a year testing scopes. The LEOPARD is the best price/best scope/best deal we've found. Packed in a hard-shell foam lined case, all units come with a one year warranty (covers the tube).

3rd generation new (4 times as powerful, 4 times the tube life!) Only \$2995! Usually priced at about \$6,000, this is the hottest unit on the market.

COBRA III+ ELECTRONIC LOCK PICK \$499

Open 90%+ of all the locks in the world in 30 seconds or less!

The COBRA III+ is made by the inventor of electronic lock picks. Magic, it's just magic. Rechargeable hot packs, Halogen key-way light, aircraft aluminum construction, thin picks, very powerful motor, rubber grips. The California state lock picking champion did 20 locks in 3-7 seconds each — on camera.

Buy the COBRA, mention this ad, & get our \$59.95 Video Tape “Superpicking” FREE!

Best books, newest videos, hottest equipment... Our new catalog \$15 — free with any purchase. If you have a specific question, please FAX us at 415-851-5403 or write via a government agency—the postal service.

CHECK OR MONEY ORDER TO:

INTELLIGENCE INCORPORATED
2228 S EL CAMINO, #349 D
SAN MATEO, CA 94403

+ \$5 shipping. CA residents include 8% tax.
(Checks held for clearance.)

INTELLIGENCE INCORPORATED

They're called Tokarevs in Russian. Berettas in Italian. And deadly in any language.

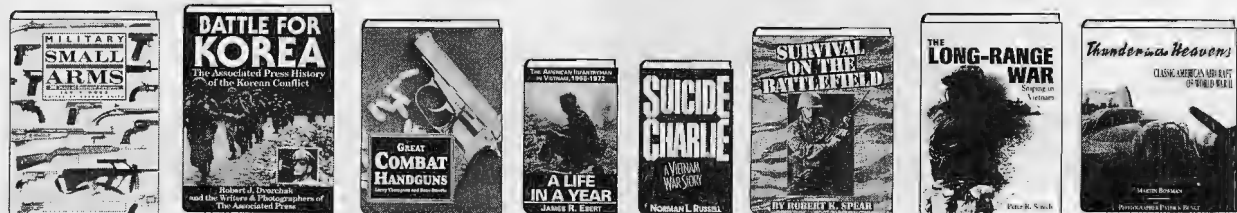

0364-9999* \$34.95x 4168-9999* \$34.95 3947 \$29.95 3434 \$24.95 3335 \$19.95 6791 \$14.95 0745-9999* \$39.95 3400 \$15.95x



0711+ \$21.95 7849+ \$9.95 0562+ \$12.50 0174 \$24.95 2279 \$23.00 3012 \$12.95x 3475 \$16.95x 2907 \$12.95x 4861-9999* \$29.95 1628+ \$14.95



0570-9999* \$39.95 0455 \$30.00 0471 \$29.95 5785 \$16.95x 0091 \$12.95x 5165 \$29.50 4721 \$12.95x 0679 \$34.95 2949 \$22.00 4853-9999* \$34.95



0356+ \$29.90 0687 \$29.95 3368-9999* \$49.95 0703 \$24.95 0273 \$12.95x 0794-9999* \$32.95 3889 \$21.95 5587 \$22.95 4549-9999* \$29.95



0786 \$39.90 7153 \$29.50 7971 \$24.95 1784 \$24.95 1776 \$22.50 8219+ \$9.95x 4481 \$27.95 0760 \$24.95 2428 \$24.95 1537-9999* \$37.50

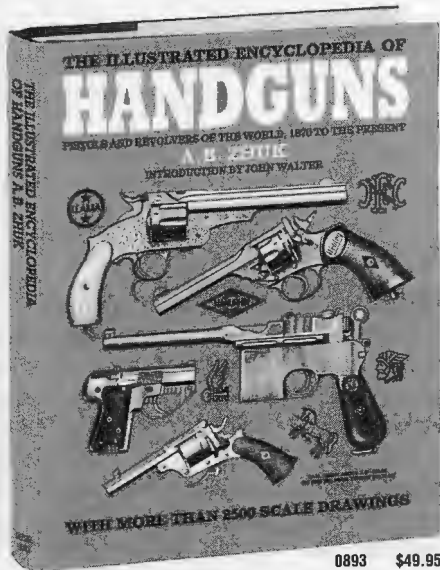

The Illustrated Encyclopedia of Handguns gives you over 2,000 of the world's military and commercial sidearms in 2,600 scale-line drawings, right down to the last lethal detail. It's just one of the many high-caliber books you'll find in *The Military Book Club*®. Join us today!

Get this book **FREE**
plus **3** more for **98¢**
with membership

0893 \$49.95



0497-9999* \$35.00 2915+ \$19.95 0521-9999* \$29.95 0133 \$22.00 0026 \$22.50 0729 \$19.95 0331+ \$14.95x 7187-9999* \$39.95 6452-9999* \$34.95



3467 \$24.95 0281 \$23.00 0307 \$30.00 3053 \$22.95 3939 \$17.95 0737 \$9.95x 4689 \$17.95 1792 \$27.50 9043+ \$15.95 0844-9999* \$32.95 0778-9999* \$34.95



0018 \$24.00 0554-9999* \$50.00 0208 \$25.00 3038 \$22.50 5561 \$24.95 2774+ \$9.95 3988+ \$9.95x 0265 \$27.50 4671++ \$22.00 0422+ \$17.85 4119 \$22.00

HERE'S WHAT YOU GET WHEN YOU JOIN...

A GUARANTEE OF SATISFACTION. Once your membership's accepted, we'll send your 3 BOOKS plus *THE ILLUSTRATED ENCYCLOPEDIA OF HANDGUNS*. If you're dissatisfied with them, return just the 3 books within 10 days at our expense. Membership will be canceled; you'll owe nothing.

THE FREE CLUB MAGAZINE. You'll receive up to 16 issues a year. Each reviews the Featured Book Selection(s) plus dozens of alternate books.

SHOPPING MADE SIMPLE. To get the Featured Book Selection(s), do nothing—it will be sent automatically. If you prefer another book—or none at all—return your Member Reply Form by the specified date. A shipping and handling charge (and sales tax, where applicable) is added to each order.

HUGE DISCOUNTS ON HARDCOVER BOOKS. Save as much as 30% off publishers' edition prices. Club books are sometimes altered in size to fit special presses.

AN EASY-TO-MEET OBLIGATION. Take up to 2 years to buy 4 more books at regular low Club prices. Afterwards, you may resign membership anytime.

RISK-FREE RETURN PRIVILEGES. If you get an unwanted book because your Club magazine was delayed and you had less than 10 days to respond, simply return the book at our expense.

* Counts as 2 choices x Special edition exclusively for Club members + Softcover ++ Fiction

Prices shown are for publishers' hardcover editions. Club hardcover editions save you up to 30%.

THE MILITARY BOOK CLUB ★★

Your #1 Source for Military Books

MAIL TO:
The Military Book Club
6550 East 30th Street
P.O. Box 6357
Indianapolis, IN 46206-6357

YES! Please enroll me in *The Military Book Club* according to the risk-free membership plan described in this ad. Send me *THE ILLUSTRATED ENCYCLOPEDIA OF HANDGUNS*, FREE, plus the 3 BOOKS I've indicated. Bill me just 98¢, plus shipping and handling.

SAVE EVEN MORE! Send me this book now and reduce my commitment to only 3 books. Bill me an added \$3.99, plus shipping and handling. Books that count as 2 choices are not eligible.

Mr./Mrs. _____
Miss/Ms. _____ (please print)

Address _____ Apt. _____

City _____

State _____ Zip _____

Members accepted in U.S.A. and Canada only. Canadian members serviced from Canada, where offer is slightly different. Sales tax added where applicable. We reserve the right to reject any application. SOF 4/95

Please write book numbers here: If you already own the FREE book offered, you may substitute for it. Simply cross out the book #0893 and write in the number of the book you prefer.

FREE BOOK #0893

58633 12

If you select a book that counts as 2 choices, write the first 4 digits of the book number in one row of boxes and 9999 in the next.



WE NEVER LEARN

As a platoon leader in the only mechanized infantry company in Haiti, I have been shocked at the total lack of understanding of how to employ mech infantry by the leaders of the 10th Mountain Division.

We are supposedly here to prevent another Somalia-type incident. Unfortunately, we (and our Bradleys) have been used for everything but, including tow trucks, taxis, grass flatteners, mobile bunkers, etc. ... Last week we were sent on two training missions that were more than 100 km away. The commanders gave no consideration to the possibility that heavy forces might be required to pull the light guys' butts out of the fire should an emergency arise.

I just think it's a shame that leaders of the 10th have already failed to learn the lessons we paid so dearly for in Somalia.

2nd Lt. "Can Do"
Haiti

MISTAKEN MINIMI

I'm sure if you had let my friend Peter Kokalis examine the photo on page 45 of the February

'95 issue he would have identified it as an M-249 Minimi with 30-round magazine and short barrel. I have the identical weapon and will be writing about it in a forthcoming issue of *Machine Gun News*.

James L. Ballou
Salisbury, Maryland

After duly examining said photo, SOF Technical Editor Peter G. Kokalis offers this ID:

Weapon: FN Minimi SAW, caliber 5.56x45mm NATO. Can use either U.S. M27 disintegrating links or M16-type magazine as shown in photo. Scope: I am not totally certain, but it appears to be some variant of the Canadian-made ELCAN 3.4 power optical sight with 28mm objective, made by Hughes Leitz Optical Technologies Limited. I do not recognize the scope-to-gun interface, ocular eye cup or what appears to be a front lens cap on top of the scope at the objective end — all of which makes me somewhat hesitant of this aspect of the photo.

TRUE BELIEVER

I am 24 years old and was shot four times while driving my Mazda Miata home from a convenience store in a good neighborhood. I wasn't able to identify the gunman or the car due to the circumstances. Needless to say I almost died; but this hasn't made me anti-gun.

My point is, guns didn't do this to me, people did. But if our politicians would put half the time into keeping scumbags where they belong as they do trying to destroy our gun rights, things would be much better in our country. If they take away assault-style semiautos, what's to stop drug cartels and other organized criminals who have always had these, and full-auto, weapons from doing whatever they want?

T. W. Allen
Jacksonville, Florida

LET VOTERS SHOOT-DOWN CLINTON

Regarding your recent admonition against attempts to remove President Clinton from office by extra-legal means, I wish to offer an even more compelling reason to keep the president alive and (physically) well. For the past 31+ years of my life I have had to endure attempts by the mainstream press to make a folk hero/martyr out of a man I considered to be flawed both as a leader and as a human being — John F. Kennedy. The mere

thought of having to endure another 30 years of media attempts to make a martyr out of the likes of Clinton turns my stomach.

Since an eternal flame to Slick Willie is more than any reasonable person could be expected to endure, I would like to make a heartfelt plea to any nuts who might happen upon this letter. Please, please, please, I beg of you, please restrain yourselves and strive to maintain your tenuous grip on reality for at least another two years. Please give the voters a chance to retire Slick into well-deserved political obscurity in November of '96. Give us all a break!

Jim Stasko
Mechanicsburg,
Pennsylvania

SOME RATS GET TRAPPED

I am writing in reference to the Mickey Downie story. I have no personal knowledge of him, but from the story, it is very clear he has been a rat all his life and whatever happens to him is exactly what a rat deserves.

Robert Fortenbach
West Palm Beach, Florida

MISGUIDED GOOD GUYS

I want to comment on Richard Sherrow's piece "U.N. Troops 'Invade' Arizona" (*SOF* Feb. '95). Hopefully, it was obvious that Mr. Sherrow's tongue was planted firmly in cheek and his sarcasm

Jerry Peterson, The One And *Only* Creator Of The Official U.S. Navy Seal Combat System, Shows You How To Defeat *Any* Fighting Technique On Earth

Compare This 'Scientific' System With Other 'Wanna-Be' Programs And You'll Instantly See Why It's Required Seal Training!

Six years ago the Navy Seals began using a scientific fighting system so powerful that today they're recognized as the most potent fighting force on the face of this earth.

The creator and designer of this system, Jerry Peterson, became the first civilian ever to standardize and license a hand-to-hand fighting system to the U.S. military. Here's how it happened and why it's important to you.

In 1989, Naval Special Warfare Command (NSWC), the group which controls all Seal activity, was looking for ways to standardize hand-to-hand combat techniques. After an exhaustive review, they had rejected every single martial art form in the world.

They found each completely unworkable in combat-oriented fighting situations where Seals were in full gear, carrying 100# packs, and often knee-deep in water.

Amazing Scientific System

Then a Seal NSWC officer (with black belts in 3 martial arts) saw Jerry Peterson's scientific fighting system. What he stumbled on wasn't martial arts. In fact it was unlike anything he'd ever seen before.

The Seal officer watched in disbelief as a class of inexperienced students threw real punches for virtually an entire hour, never repeating the same sequences. In one session he witnessed more fighting than most martial arts students see in a year.

Later, two top brass at NSWC saw the officer demonstrating moves he'd learned. But intrigue turned to doubt when they learned the originator was an ex-Army enlisted man.

Still they met with Jerry, as much out of admiration for his Vietnam record as anything (he spent 15 months as lead point for Charlie Company, the 173rd Airborne — one of the most decorated units of the war). The Seal officers, Vietnam vets themselves, figured Jerry at least ought to understand their needs.

But they were totally unprepared for what happened next. To prove his system, Jerry Peterson and a highly-decorated Seal Commander (and at 240, 100 pounds heavier than Jerry) went toe-to-toe — but at half speed. To the Commander's amazement he was instantly disabled and dropped to his knees.

Only then did he realize — had he not been talked out of going full speed by others who knew the awesome power of Jerry Peterson's system, his false confidence in his martial arts training and in his sheer size advantage would have left him with an arm broken as easily as a match stick!

'Blown Away' In Just Minutes

In 5 short minutes these Seal officers — men who had seen everything in the way of brutal fighting, and who had virtually unlimited budgets to develop the Seals into the world's best — were blown away by Jerry Peterson's *Autokinematic*™ fighting system.

Following a pilot program at Command headquarters all Seals began receiving this training. Still, hard-headed, cocky, non-be-

lieving Seals, many with extensive martial arts backgrounds, constantly tested Jerry in situations like these:

❑ Seals are the most proficient combat swimmers in the world. Yet 40-year old Jerry (who wasn't a particularly good swimmer) "drowned" Seal after Seal in training. His scientific principles (this isn't a graceful art form) apply on any terrain.

❑ Seals are trained to run 20 miles in soft sand. But Jerry (who really wasn't in great shape) had them gasping just 5 minutes into his first workouts while he participated effortlessly. He used breathing techniques others had never seen (techniques he can teach you in minutes).

❑ Once, Jerry challenged an entire platoon to pin him against a wall. All thought it a joke. Yet he escaped — from the grasp of 14 of the most proficient fighting men in the world (then demonstrated it was no trick — simply physics, and easily learned).

Today all Seals use these scientific techniques and many more. Since 1989 Navy Seal platoons go through a minimum of 40 rigorous hours of Jerry Peterson's training prior to deployment.

His system was demonstrated to Navy Admirals, a 4-Star General, and Congressmen — as well as the Secretary of the Navy and the U.S. Secretary of Defense!

Jerry was even called in prior to Desert Storm to brief the military on using *Neural Offensive Linguistics*™ (a cornerstone of his system, it defines a mind set which eliminates all defensive thinking, allowing anyone [even you] to make instantaneously clear and correct decisions in the midst of any hostile environment).

Devastatingly Powerful

Yet if you expect to use Jerry Peterson's military techniques in civilian situations you're going to get yourself into trouble. Military confrontations are simply not the same as civilian.

What you need to know are methods even the military is not taught.

And now, in the most recent release of his system, Jerry reveals the specific techniques you must know to control any hostile civilian situation. It's called *Jerry Peterson's Hostile Control System*, and used correctly, this system is undefeatable.

In *Hostile Control* you'll find out how you can quickly (in no more than a day) learn to defeat or seriously disable anyone threatening your life or the life of a loved one! You get the same devastating power the Navy Seals use. It's just directed towards civilian confrontations.

Combat Proven

Everything in this system was proven in the most intense war lab of the past 30 years — Vietnam! But please understand.

This is not a course to impress friends at your local Karate studio. It's a professional fighting system.

You won't see Jerry Peterson or his pro-

fessional instructors on the Ultimate Fighting Challenge. This isn't sport fighting. Professional fighting has but one objective: to defeat an attacker. And to do it incredibly fast — in 20 years Jerry's longest fight lasted a mere 5 seconds!

This system is only for those who need a powerful yet amazingly simple system (simple because it's based on quickly-mastered scientific principles not on a difficult art form) to protect them in life-threatening situations.

No Navy Seal has every lost in hand-to-hand combat when correctly applying his system! And they never will because...

This System Is Undefeatable

One more thing. Cheap imitators may try to claim they've trained Navy Seals, but let me explain what they've actually done.

Seal platoons have discretionary funds which they use to bring in all sorts of instructors. For example, they've hired the Evelyn Wood™ company to teach speed reading.

And that's the level these cheap imitators are working at. They've gone in at an 'Evelyn Wood' level and given their program to a platoon — maybe to just 1 or 2 men. But they're not the genuine thing.

Jerry Peterson is the sole creator of the official combat fighting system used by the U.S. Navy Seals today.

Want to call these imitator's bluff? Jerry's official Naval Special Warfare course number is K-431-0096. Under the Freedom of Information Act call the Government Information Office and verify for yourself that this course, *Special Combat Aggressive Reactionary System (SCARS)* truly exists. You won't get details about it because it's restricted.

But ask these Navy Seal 'wanna-be' trainers what their official government course number is. You'll find they haven't got one!

In fact, if you're in a violent confrontation and all you have is these 'wanna-be' techniques, you might just be safer pulling out a book and trying to impress the assailant with your speed reading skills!

So now you decide. Do you want to learn 'disguised' martial arts from cheap imitators coming in at the level of Evelyn Wood instructors?

Or will you make the decision the Navy Seals made — and go with Jerry Peterson, the genuine developer of the official U.S. Navy Seal combat fighting system?

Free Special Report

Jerry Peterson has created a **Free Special Report** which reveals amazing details about his scientific fighting system — the system which has made the Navy Seals an undefeatable fighting force.

It's easy to get your copy. Just call this 24-hour, toll-free recorded message now:

1-800-600-1420

© Copyright 1995 Charlton & Co., Inc.

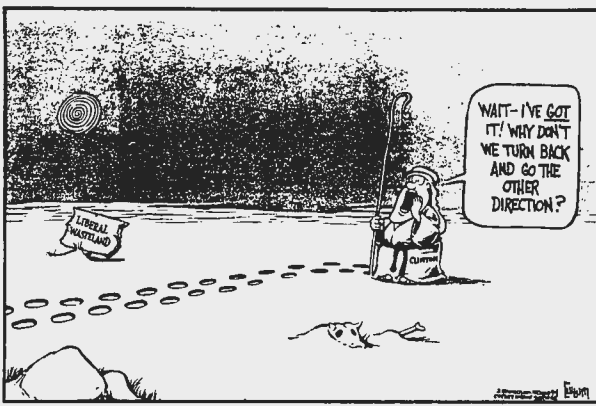

should not blind us to the good intentions of his article.

His points regarding the immediate and possibly long term negative effects of this affair should be well taken. This is just the kind of thing that plays into our enemies' hands, as surely as that idiot firing on the White House.

On the other hand, I wanted to commend you folks out there in Wickenburg for your quick, though ultimately

misguided, response to the perceived threat. It was clear by the article and my own reported version of the story that cooler heads prevailed in the end and you should be applauded for the fact that nobody was hurt.

To the *SOF* staff: This incident illustrates the fact that many of us readers are becoming increasingly concerned by the directions we see our nation, and the world, heading. *SOF* stands as one of our

excellent sources for hard facts, good information and guidance. We need more of the above and less sarcasm toward people whose hearts, at least, were in the right place.

Magnum
Ridgecrest, California

VIVA ZAPATISTA!

Colonel Rex Applegate's article ("Time Bomb On U.S. Border, *SOF* Feb. '95) was both timely and most informative. We who live in Southern California are acutely aware of the continuing silent invasion of Mexicans fleeing their country to improve their financial opportunities, rather than take action to change and correct the problems with their oppressive, elitist, on-the-take political leaders. In stark contrast, the rebel Zapatistas based in Chiapas state have cho-

sen to fight for change. Mexico, whose main export to America is illegal immigrants, is experiencing a stillborn NAFTA, a rapidly vaporizing peso, yet still managed to con Clinton into raising its credit line to \$9 billion. Quite a feat from a country with an internationally known lousy credit rating. The American middle class taxpayer (a non-existent class in Mexico) will largely pay for this megabuck handout, just as we already pay for the millions of illegals willingly fleeing their native country to pitch their tents here. Bubba Bill the Waffle King cares more about the border security of Kuwait than of the United States.

The only genuine and long-term solution for Mexico's problems is offered by Marcos and his Zapatistas. They are committed to stay and fix their

SKS • MAK-90 • AK ACCESSORIES

AK & SKS FRONT SIGHT TOOL all steel, adjusts windage and elevation. (#G2033) \$29.95

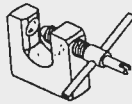

SKS and AK PEEPSIGHT All Steel. No modifications. Fully adjustable for windage and elevation. SKS (GSK1300) AK & MAK-90 (GAK1303) \$29.99



SKS MAXI BREAK provides excellent muzzle control, reduces recoil and Looks Great. (#G2055) \$44.95

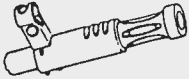

AK RECOIL COMPENSATOR Based on the original Kalashnikov design, but made in the USA. (#G2005) \$36.95



Exact copy of Russian Unit

BEST SELLER! SKS & AK OWNERS MANUAL a must for every SKS, AKS or AK-47 owner or user. (#GB-896) \$3.95

AK SPEED LOADER original Chinese (#G2001) \$8.95



MAK-90 FIBERFORCE STOCK The perfect alternative to the factory wood stock. Based on the DRAGUNOV design, these black Zytel stocks come with handguards. (GAK2011) \$89.99



AK or STOCK EXTENSION, black rubber buttpad, extends the stock out an extra inch. Has hole for easy access to cleaning kit. AK Stock extension (#G2006) \$9.95 SKS Stock extension (#G2007) \$9.95



MAK-90 MUZZLE BRAKE Easily installed. This brake will increase muzzle control during rapid fire to ensure quicker target alignment. (GAK2035) \$34.95



AK 4-POCKET SIDE POUCH Original East German, holds four 30-round mags. Rain camo with belt loops. (GAK1621) \$14.99



AK and SKS FOLDING BI-POD all steel. Attaches quickly. (#K1790) \$46.95

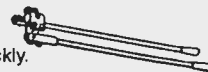

SKS/AK STRIPPER CLIPS These are new, no rust! 10 per pack. (#G2013) \$8.95



SKS STEEL VENTED HANDGUARD Simply replaces the existing handguard to give any model SKS exciting new appeal. (GSK1150) \$11.99

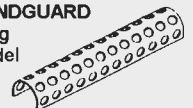

SKS MONTE CARLO STOCK of high quality black Zytel. Comes complete with checkered grip, matching handguard, sling stud and rubber buttpad. (GSK2078) \$59.99

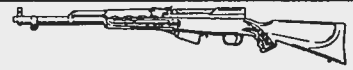

AK VERTICAL FOREARM offers more control and less heat buildup. Works on all Norinco or Polytech AKS. Sturdy one-piece construction. (#G2039) \$32.00



AK and SKS 5-PIECE COLORED FRONT SIGHT SET gives you a better sight picture than ever before. Red, white, yellow, orange and black. (#G1305) \$4.95 set



ORDERS ONLY CALL 1-800-239-7435
205-222-1931 / FAX 205-222-2309

SHIPPING CHART	ADD
0.00 - 35.00	4.95
35.01 - 60.00	5.95
60.01 - 100.00	6.95
100.01 - 150.00	7.95
150.01 or over	8.95

*AK, HI, Canadian orders add \$4.00.

CALL TOLL FREE TO ORDER OR SEND CHECK OR MONEY ORDER TO CROWN SPECIALTY CO. DEPT. SF, P.O. BOX 488 • ANDALUSIA, AL 36420

native country's ills, much like our own Minutemen generations ago. A sick country is like a sick person, in that the diseased tumors need to be cut out and removed for a sure cure. If I could aid Marcos, I sure as hell would.

W. M. Lawson
Costa Mesa, California

THE LAW CAN LEAD TO TYRANNY

I beg to differ with one facet of Alex McColl's excellent February "Command Guidance" column. Mr. McColl asserts that there is no need and no justification for armed resistance to legally elected authority.

Tyrannical governments can and have resulted from lawful democratic sanctions. Suppression of speech, interference with the electoral process and genocide on massive scales have been the results. Obviously, armed resistance to these elected authorities would be justifiable.

Recently, here in our own country our government has, among other things, murdered fellow citizens, violated our privacies and suppressed free speech. And they remain unaccountable, aloof and arrogant. We need to remember that we are not a democracy, which is merely an organized form of mob rule where individual rights are easily lost. We are a constitutional republic, where each individual citizen's constitutional rights are paramount and are supposed to be protected by, not from, the government. Per Jefferson, Blackstone, et al, even when a legally elected government ignores its oath of office and oppresses the rights of its citizens, the citizens have every right to remove that government, by violence if necessary. Obviously, the preferred method is the ballot box, but such means are not always possible.

Larry Hokenson
Isanti, Minnesota

WRITE TO SOF

Send confidential documents, government secrets and your opinions to SOF, c/o FLAK, PO Box 693, Boulder, CO 80306. Due to limited space we reserve the right to edit for brevity. ✕

NIGHT VISION
WAREHOUSE U.S. Distributor

Military Optics Co.

NS-5 (NS2ar)
2nd Gen US (3rd-Russian)
Weaver/Dove-tail mounts



Rifle Scope Range: 550 yds
Gain: 65,000x, Lens Power: 3.5x
Cross-hair (aim point optional)

AVD-2
Goggles w/IR, focus, Gain:50,000x



ADV-4
Panoramic Viewer w/IR, Focus and diopter.
Gain: 65,000x, 2nd Gen



B-12
Lens:2.8x Gain:40,000x Range:280 yds



Other best-sellers: B6-P rifle scope, B-6, B-7, H3T-1 w/IR. We carry a complete line of night vision and daylight optics: U.S. and foreign. Our devices feature automatic brightness control, image tube protection and a rugged metal construction. Designed for special forces, all devices are brand new, grade A only, and they come with daylight filters, carrying cases, a full 2 year (!) warranty and a 30 day money back guarantee: If you don't like it, return it for a full refund! Our competitors often sell identical devices under different names for much more money; remember to ask us for a cross-reference!

LOWEST PRICES!!! FROM \$169

800-850-5010 8-5 CST. Visa. MC. COD
Universal Trade, Inc. P.O. Box 3894
Carbondale, Illinois 62901-3894

STEREROIDS

D-BALL TEST JET DECA

Anabolic Steroids build Muscle Mass and Strength
Now there are safe and effective replacements for steroids
PRO BODY® Power Formulas

Leading Steroid Replacer
Huge gains in muscle mass and strength have been reported from Boron users. Completely legal and no side effects. Gains won't be as good as with steroids for most, but response is great and lifters are coming back for more. The extra edge. Boron.
BORON 3 month cycle #55001 \$15.95

The Real Thing - Dibencozide
Dibencozide has proven **Anabolic** effects. Gain **Weight**. Get **Strong**. Fast Recuperation. **Guaranteed**. The problem is that a lot of the Dibencozide out there is not real. **PRO BODY** Dibencozide is the only one that comes with a copy of the lab analysis that proves it is 100% real. Get **big** today.
DIBENCOZIDE 90 caps 10mg #55006 \$34.95

Build Mass and Lose Fat
Human Growth Hormone increases lean Mass and decreases body fat. The ingredients of GH Power Formula have been proven to naturally **increase** Growth Hormone levels up to **700%** in 90 minutes. GH levels still **300%** higher 8 hours later. Get the **hard** look with GH Power Formula.
GH POWER FORMULA 90 tabs #55024 \$24.95
GH POWER FORMULA 180 tabs #55025 \$44.95
the ultimate **Mass Formula**
Get **big** now. Combine all of the **best** Power Formulas for **Ultimate** gains. Boron, Dibencozide, Yohimbe, Smilax & Amino's in a **huge** 60 day cycle. **Guaranteed Size**. Get it all with the **Mass Formula**. At a 30% savings.
MASS FORMULA 60 day cycle #55050 \$89.95

All PRO BODY Power Formulas are 100% GUARANTEED or your money back



FREE CATALOGS

CALL 1-800-962-4769 ask for dept. #734

FAST SHIPPING

Toll free - 24 hours - 7 days
Send to: JTR Labs - 10230 Bach Blvd., Dept #734 - St. Louis, MO 63132
For questions and local orders call 314-426-7040

RUSH ORDER FORM

Name (as on card) _____
Address _____ Apt.# _____
City _____ State _____ Zip _____
Phone#() _____
Card# _____ Expires / _____

PRODUCT	ORDER#	QTY	PRICE	TOTAL
-IMPORTANT ORDERING INFORMATION			SUB TOTAL	
-Foreign orders add 25% of total in US funds			SHIPPING 4.00	
-Fedex 2nd day air add \$5.00			Missouri add X .06225	
-COD orders add \$4.00			OTHER	
-AMEX must be shipped to billing address			TOTAL	
-Dealer inquires welcome				

SEND TO: JTR Labs
10230 Bach Blvd. - dep#734
St. Louis, MO 63132

WORLD SITREP

1

UNITED STATES

Both U.S. Army combat divisions in Europe report Cat-2 status — not fully ready for combat — for first time since World War II.

Downsizing has left military with huge stockpiles of ammunition (far more than can be used in training), meaning new orders are not materializing. Contractors are shutting down production lines, decreasing ability to produce ammo at wartime rates. Current stockpiles, although large, are not adequate in some categories for another Desert Storm.

Air Force will try Capt. Jim Wang, chief controller on AWACS plane that sent two U.S. fighters to shoot down two U.S. helicopters by mistake, on three counts of dereliction of duty. Charges against both fighter pilots and other controllers dropped.

2

CHINA

Chinese nuclear submarine approaches USS carrier *Kitty Hawk* in Yellow Sea, touching off a 48-hour duel of wits as sub tries to get close. When U.S. helicopters dropped sonobuoys on sub, Chinese fighters threatened to shoot them down. Submarine eventually withdrew but China vows its forces will be authorized to “shoot to kill” U.S. units that harass them in future.

16

1

6

HAITI

U.S. officials announce they have broken the back of paramilitary groups and are beginning process of transferring peacekeeping operations to United Nations. White House abandons plans to have Lt. Gen. Daniel Schroeder command U.N. force because such an appointment would require Senate confirmation, opening door to examine administration's entire Haitian policy.

One U.S. soldier and one Haitian killed mid-January at checkpoint shoot-out.

7

SOMALIA

Bangladeshi troops abandon base at Afgoye and have to fight their way out under cover of U.N. armor and Cobra helicopters. Somali gun-trucks try to stop withdrawing peacekeepers and demand two years' rent on base.

U.S. 13th amphibious group with 3,000 Marines stationed in Kuwait available to help evacuate U.N. forces. Last Indian troops leave Somalia and Zimbabwe begins its withdrawal.

6

14

10

BURMA

Government troops round up 300 “volunteers” to serve as porters in new offensive against Karen rebels. Several hundred Karens mutiny against their commanders threatening survival of 45-year-old insurgency. Karen National Union believes government spies caused incident.

11

JAPAN

Charity fund seeking voluntary contributions from Japanese corporations for compensation to Western military personnel held in Japanese POW camps during World War II has been abandoned. POW groups plan to file suit in Japanese courts demanding \$22,000 for every prisoner or his estate.

12

BOSNIA

Former U.S. President Carter reaches cease-fire agreement with Bosnian Serbs. Fighting continues at Bihac, not covered by cease-fire because rebel Muslims and Krajina Serbs fighting there were not party to agreement. Siege of Sarajevo reaches day 1,000 on 31 Dec 1994 with more than 10,000 killed and 50,000 wounded.

3

RUSSIA

Scientists claim to have solved known problems with hypervelocity (670 mph) underwater missiles and are seeking international partners to develop them. Such missiles use kinetic energy to destroy targets.

New TKB-722K grenade launcher has been developed to replace AGS-17. It fires same 30mm ammunition but is lighter, more compact and has only 40% as many parts.

Defense Minister Grachev admits Russian planes bombed airfields at Grozny but only to prevent Dudayev from flying in more mercs. Cox News Service reports Chechens might have parts of a nuclear weapon — Dudayev was commander of a Soviet nuclear bomber wing. U.S. officials investigate reports of Chechen rebels shooting down Russian aircraft with U.S.-built stinger missiles supplied by former Afghan rebels.

5

CAMBODIA

Government forces capture key Khmer Rouge base on Koulen Mountain. KR begins scorched earth policy in northern Cambodia and accuses government of chemical warfare in Preah Vihear province.

4

NORTH KOREA

Kim Jong-Il fails to appear at rally celebrating third anniversary of his promotion to commander of armed forces, fueling more rumors he is seriously ill or losing power.

3

9

SOUTH AFRICA

State-owned arms company, Armscor, admits producing small amounts of poison gas for testing chemical defense equipment. Crime wave forces government to deploy soldiers in Johannesburg to back up police.

8

RWANDA

U.N. officials report that witnesses to massacres of Tutsis by Hutus are being singled out and executed by Hutu militia who control refugee camps in southwest Rwanda. Officials also report two or three people killed each night in gruesome voodoo rituals in Tanzanian camps.

12

13

2

4

11

15

13

TURKEY

President Demirel vows to continue war against Kurdish PKK separatists despite 14,000 lives lost. More than 10,000 Turkish troops move into Tunceli province to rout an estimated 1,000 PKK rebels.

10

5

14

NICARAGUA

Parliament bans sitting presidents or their relatives from running for reelection, although they can run again after missing one term. This allows Daniel Ortega to run in 1996, but excludes current President Chamorro.

8

7

9

15

SUDAN

Eritrea breaks diplomatic relations with Sudan because fundamentalist groups trying to overthrow government are based inside Sudan. SPLA rebels attack Kapoeta and capture an ammunition dump. Five thousand refugees flee into Uganda to escape fighting.

16

CANADA

Separatist government of Quebec introduces measure in provincial parliament that would make province an independent country one year after a referendum in favor of the move.

World SitRep is excerpted from the biweekly newsletter *For Your Eyes Only: An Open Intelligence Summary of Current Military Affairs*. Published by Tiger Publications, P.O. Box 8759, Amarillo, Texas, 79114-8759; subscriptions are \$65 per year (26 issues). Sample issue available for \$3. Those interested in reliable, up-to-date world intel are encouraged to subscribe.



SOF 20th Anniversary

GREAT GUNS GIVEAWAY!

Enter Sweepstakes for your chance to win this E.A.A. Witness 9mm Pistol



**New Gun
Each
Month!**



YES, HERE'S MY ENTRY SIGN ME UP!

- Enter my name, send me a 1-yr. sub. for \$26.20
- Enter my name, send me a 2-yr. sub. for \$50.00
- Enter my name in the sweepstakes only.
- Credit card orders may call 1-800-877-5207
- Bill me.
- MasterCard Visa Exp. Date _____

Card # _____

Signature _____

Name _____

Address _____

City _____ State _____

Zip _____

Day Phone () _____

Canada add \$10.00 per year (includes GST #R128476249).

Foreign add \$21.00 per year

POSTMARKED DEADLINE: 30 June, 1995

SWEEPSTAKES DRAWING: 7 July, 1995

MONEY BACK GUARANTEE

A20495

* Based on newsstand price of \$3.95. No purchase necessary to win

Fill out the entry card (or coupon) and send to SOF, P.O. Box 348, Mt. Morris, IL 61054-0348 via U.S. mail with entry postmarked no later than 30 June, 1995. No entries will be accepted after this date. Winners will be selected by random drawing on 7 July, 1995, and will be notified by mail or telephone. No purchase necessary to enter. All prize winners must comply with Federal, State and local firearms regulations, where applicable. Judges' decisions are final. Sweepstakes open to residents of the U.S. 21 years of age or older. Prize non-transferable. Odds of winning are dependent upon total number of entries. Winners will be printed in a future issue of Soldier of Fortune.

• For name of prize winner, send SASE to April '95 Sweepstakes Winners List, c/o SOF Magazine, P.O. Box 693, Boulder, CO 80306

SLICK WILLIE WATCH



HOMELESS VETS TAKE NOTE:

While the Clinton administration whacks and whittles away at the national defense budget, included in the federal budget is a housing allowance for the folks who once operated the nuclear weapons aimed at the United States. The Pentagon has announced a joint U.S.-Ukraine venture to build a \$16 million apartment complex in Khmel'nitskiy, Ukraine, for former Strategic Rocket Forces officers and their families. The money is part of a broader, more costly, Pentagon effort to

assist Russia and other former Soviet republics in dismantling their nuclear arsenals.

BRADY BASHING

So far, 10% of the states have had the Brady bill — Slick Willie's flagship legislative "accomplishment" — knocked down in federal court. A federal judge in Louisiana ruled the background check provision of the bill unconstitutional because it shanghais state officials to implement federal law. Similar decisions have been handed down in Arizona, Mississippi, Montana and Vermont, and a

kindred lawsuit is pending in New Mexico. A federal judge in Texas upheld the law as constitutional because, as he read it, a sheriff would not be overly burdened by having to make background checks.

CLINTON CAMPAIGN SHOWS MORE THAN \$4 MILLION IN "IRREGULARITIES"

Auditors from the Federal Election Commission have recommended that President Clinton's 1992 campaign be ordered to pay the United States more than \$4 million for "irregularities" — a record for presidential elections.

Some \$3.8 million was assessed Clinton's primary campaign, and \$254,546 was assigned to the general campaign. The bulk of the primary total, \$3.44 million, is for federal matching funds the campaign received, but for which the auditors say it was not entitled.

Auditors also uncovered nearly a quarter of a million in what they say were impermissible contributions such as extensions of credit and the use of corporate facilities by the Clinton primary campaign — including monies paid to a video production company

EAGLE INDUSTRIES



QUALITY BY DESIGN

Tactical For The Professional.....



SAS MK III



TAC VI N



BPP

EAGLE INDUSTRIES UNLIMITED INC. is the largest manufacturer of tactical equipment ranging from 9 different styles of tactical and loadbearing vests to 23 different styles of tactical holsters and rigs. We also offer a full line of rappelling gear, duty gear, gear bags and packs, as well as rifle and submachine gun cases. All Eagle Products are made from the Highest Quality material and worksmanship, and backed by a **LIFETIME GUARANTEE!!!!!!**

"Quality By Design"

"Lifetime Guarantee"

Contact your nearest Eagle Dealer or send \$3.00 for a 1993 60 pg. catalog of our complete line.

Eagle Industries Unlimited Inc.
400 Biltmore Dr. Ste 530
Fenton MO 63026
314-343-7547 Fax 314-349-0321



VISA

Master Card

owned by Clinton crony Harry Thomason, a Hollywood producer.

FOSTER DEATH

A federal grand jury investigating the death of former deputy White House counsel Vincent Foster has questioned a number of subpoenaed witnesses, including a number of rescue workers and police officers. The witnesses were subpoenaed as part of the ongoing investigation by Whitewater independent counsel Kenneth Starr into the circumstances surrounding the death of Foster in July, 1993. Foster's body was found in a Virginia park with an antique revolver in his hand.

A controversial probe made earlier by Robert B. Fiske Jr., based on interviews conducted by his staff, concluded that Foster shot himself in a fit of

depression over adverse press. Starr said he will make his own "independent judgment" regarding the cause and manner of Foster's death.

At the time of his death, Foster was working on financial matters for the president and Hillary Clinton, a former partner in Foster's old law firm in Arkansas.

Two of the testifying witnesses had earlier told the FBI that they saw a briefcase in Foster's parked car at the park where he died. In addition to questions surrounding the suicide, Starr has been investigating presidential aides' handling of documents in Foster's office after the death. Some of the documents in question involved president and Hillary Clinton's Whitewater real estate ventures. Questions surrounding the briefcase are

significant because it was there, six days after Foster's death, that White House officials found a torn suicide letter.

Meanwhile, Senate Banking Chairman Alfonse D'Amato has vowed that the next round of Senate Whitewater hearings will "fully" explore contradictions in prior testimony by White House officials. D'Amato's promise came as Senate Democrats were completing *their* report, which documents contradictions in sworn testimony by White House officials last summer, relating to the question whether the Clintons' land deal or their gubernatorial campaign received money improperly siphoned from a failed savings-and-loan company owned by their Whitewater partner.

D'Amato's banking panel will conduct Whitewater hearings, but he has

indicated he would delay the next round to avoid interfering with the heating-up probe by Starr. D'Amato has urged Starr to consider prosecuting some Clinton aides for perjury to Congress.

SEXUAL HARASSMENT SUIT DELAYED, BUT NOT DENIED

Judge Susan Webber Wright of Little Rock, Arkansas, has ruled that President Clinton has no immunity from civil suits in the sexual harassment suit by Paula Corbin Jones, but that the suit can be delayed until Clinton leaves office. She also ruled that the parties could proceed with pre-trial fact-finding to ensure that the case would not be compromised by fading memories; dated evidence or disappearing witnesses. Clinton's lawyers plan to appeal. ✕

NIGHT OPERATIONS SPECIALIST Now You Can Own The Night!

SHOPPING LIST

- a ___ Night Vision Goggles (NVG)
- b ___ Aviation NVG - ANVIS
- c ___ NVG Magnetic Compass HUD
- d ___ Night Vision Binoculars
- e ___ Night Weapon Sights
- f ___ Night Photography Scopes
- g ___ Laser Weapon Aimers
- h ___ IR Flashlight Filters
- i ___ IR Chemical Lights
- j ___ IR "Fireflies"

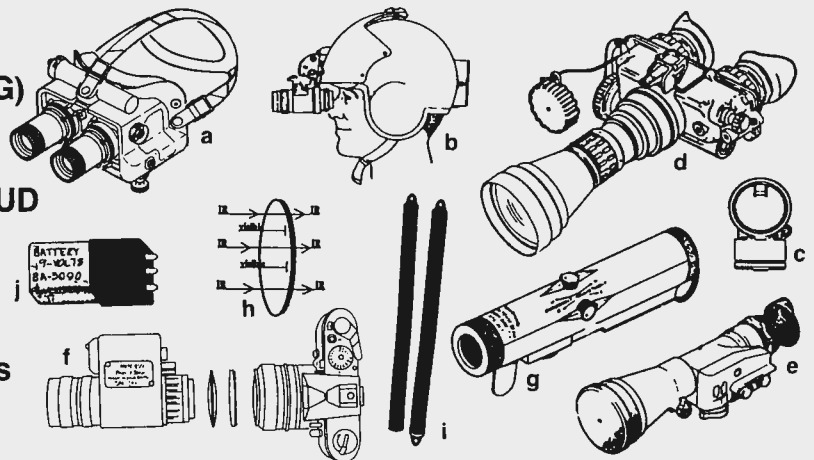

Call for FREE Product Listing or send \$4.00 for complete catalog!

FFL DEALERS CALL FOR SPECIAL SAVINGS & NEW PRODUCTS!

1. Our night vision systems are manufactured using the finest in NEW components and image intensifier tubes.
 2. Our image tubes are MADE IN THE USA by a major manufacturer of night vision systems for the US Military (no Russian surplus).
 3. Our systems are WARRANTED for TWO FULL YEARS.
- WORLD'S LARGEST STOCKING DISTRIBUTOR OF U.S.-MADE NIGHT VISION EQUIPMENT!

EXCALIBUR ENTERPRISES, P.O. BOX 400, FOGLESVILLE, PA 18051-0400
(610) 391-9106 Special equipment for NIGHT OPERATIONS FAX (610) 391-9223

“And, of course, the most amazing thing is how fast you can learn it!”

Top Secret Hand-To-Hand Fighting System Finally Released To Limited Number Of Civilians!

Now, with the sudden release of this incredible elite military fighting system, you can easily “take down” trained boxers, Karate black belt masters and street thugs twice your size... even if you’ve never been in a real fight before in your life!

— by Dr. R. L. Horine —

Dear Friend,

A year ago I would have *never* written you this letter. You see, I’ve gotten on the “inside” with some of the most dangerous soldiers and law enforcement people on the planet (including members of the Navy SEALs and combat instructors for the DEA, Army Rangers, major police department SWAT teams and others.)...

We all shared the same arrogant attitude: This new “simplified” hand-to-hand fighting system created for combat and intense criminal warfare should *not* be released to the general public. Because...

It’s Just Too Dangerous To Be Allowed To Fall Into The Wrong Hands!

I initially felt the same. But I’ve recently changed my mind in a big way... all because of a beautiful woman named Julie. I’m ashamed that I withheld these important street-fighting skills from people like her — good people (like you, too), who are *unnecessarily* walking the streets as living targets for the criminal scum who prey on innocent victims and just love to humiliate and ruin people’s lives.

Here’s what happened: Julie was assaulted and badly beaten, by a man she could have easily knocked unconscious and escaped from — if only I had taken **15 minutes** to teach her what to do! It doesn’t matter that she’s a petite and gentle woman. The few simple skills of this new fighting system can be taught to *anyone* in an almost unbelievable short time, because it requires no strength, no agility, no special talents, no speed, *no nothing!* Forget what you see on T.V. — the most effective fighters in the world never use spinning head kicks or elaborate punches... in fact, they never “punch” at all. It’s all so much more **simple** than that — I’ve seen 60-year-old grandfathers and 13-year-old teenagers *master* this stuff almost overnight. For people like *you*, well, it’s even easier.

Julie knows how to defeat 99% of all street thugs **now**... but she was taught just a little too late to avoid those emotional scars she’ll have to live with for the rest of her life. And now, in all honesty, I’m doing my damned best to make sure every “good guy” I can

reach *never* has to go through what this lovely lady did...

And I Don’t Care What The Military, Or Anyone Else, Says!

Here’s the bottom line: How safe do you feel in today’s jungle-world? Are you even remotely interested in learning how (in a matter of mere hours) to turn any attacker or bully into a pile of bleeding beef at your feet — and so *automatically* — that you (or your loved ones) can always *terminate a dangerous physical assault situation before it even begins?* Would you like to have the confidence to walk nearly any street in the world, any time of day or night... knowing without question you can “neutralize” the threat of physical assault by criminal scum as easily and thoughtlessly as you would shoo away an alley cat?

I guarantee that if you are like every other man I’ve talked with in the last year, just *reading* this short message you have in your hands will start amazing changes to happen in your life! Changes that will turn you into a true modern-day warrior...

With So Much New Confidence Leaking From Your Pores People Will Take Notice From Across The Room!

I don’t care if you’re in the worst physical shape of your life, or even if you’ve never hit another person before, or don’t have the coordination to walk and chew gum.

Julie learned it... *and* a thousand guys smaller and weaker than you have learned it, too. Almost *overnight*. A Navy SEAL combat instructor told us that this fighting system can turn *anyone* into a potent hand-to-hand fighter. He said it’s amazingly easy to learn, easy to remember, and best of all, easy to *use* when needed!

Are you skeptical? Good. That means you’re not gullible, not easily fooled. But then almost everyone I’ve met in the last year has been just as skeptical as you. And listen to what happened:

— A pint-sized writer I know from Los Angeles was nursing a broken rib when he was bear-hugged from behind by a construction worker bully who outweighed

him by at least thirty pounds. Now, this writer had never been in a real fight before in his life... in fact, his only training came from just *watching* the 8 basic moves of this fighting system on video tape... one time! Yet he automatically used one of those “moves” the second he felt his rib begin to give...

And Was Astonished To Turn Around And See His Attacker Down And Whimpering On The Sidewalk!

—A fairly well-known West Coast body-builder and ex-college middle linebacker named **Bob Pierce** (6 foot 4, 240 pounds of raw muscle), who also had studied Judo for 4 years, absolutely did *not* believe that a little guy like me (5’ 6”, *maybe* 170 lbs. soaking wet) could “put him down” *if he surprised me from behind!* Well, I did... and he’s still tender where I “controlled” him with the simplest little move — and damn lucky I decided not to teach him a *real* lesson about going after smaller guys!

—A working mother named **Cindy Bowes** from Ohio... after *glancing* at this stuff (on a video), could only remember **one move** when she was assaulted by a man on her front lawn — but that one move put her assailant into such a boggled state that she was able to leisurely call the police and have him hauled off.

Here’s how this amazing fighting system “leaked” from the most elite military circles into your hands: You’ve never heard about **Paul Vunak**, but the SEALs, FBI, CIA and a dozen police department SWAT teams have. He is without question one of the most respected — and *dangerous* — men in the world at hand-to-hand combat — teaching it, and using it. For over 20 years he’s been mixing it up with every sort of fighting “expert” you can imagine... on the street, “in the clutch”, and in thousands of situations where his life was absolutely on the line.

The U.S. Navy SEALs brought Paul in to teach them his unique system after an exhaustive worldwide search for the *best* hand-to-hand combat system in existence. Paul didn’t ask them, mind you... **they** asked **him**. That’s how serious Paul’s reputation is in the world of real-life warfare. The

SEALS, you probably know, are flat-out the most deadly-efficient soldiers on the planet. They won't even *consider* a fighting system — especially a hand-to-hand one — unless it can be taught quickly and used with **100% effectiveness, 100% of the time.**

These Professional Soldiers Know If Their Training Fails, They Will Die In Combat!

That's why the SEALS *love* Paul's system. It incorporates real-life fighting tools no other system has; yet it can be mastered in an astonishingly short time. These soldiers have to spend most of their training time getting in shape, learning complex weapons, and studying top secret military operations. They simply do not have the time to bang around in dojos learning complicated martial arts like karate or Tae Kwan do.

In fact, if you talk to a SEAL about martial arts, he'll *laugh* at you. They know it can take *10 years* to become a black belt in any given discipline... and even then, your average YMCA-trained boxer will still dismantle your ass in about 10 seconds!

Most of these super-elite soldiers have black belts in a martial art (sometimes three or four)... but they don't even *consider* using any of it. All that fancy kicking and hacking may look scary, but it doesn't work on the battle field... or in the street.

It simply doesn't work.

Imagine this: You're a SEAL out in the action; you've just crawled through miles of dense jungle, you haven't eaten for three days, you're dehydrated, sick from dysentery, wounded in two places, out of ammo, and carrying a sixty-pound pack.

You *ain't* gonna rely on a Hollywood spinning round-house kick when the enemy ambushes you. That's not the way real fighting happens. And that's why Paul Vunak's "simplified" hand-to-hand system is so treasured by the soldiers and police and federal agents who need to *rely* on it.

*** There are no complicated moves!** In fact, in Paul's "basic" system, there are *only 8 moves total!* And all of them are unbelievably effective, and all can be learned and *mastered* in only a matter of hours.

*** You don't have to be quick, or coordinated, or even in decent physical shape!** All the deadly power comes from extensions of the way your body *naturally* moves. This is called your "gross motor skills" — the same simple movements you use to walk across the room, to scratch your ear, or to step into a car. (I've seen 5-year-old kids who still run funny take down bullies twice their size and age... and little old ladies with limps cancel out young violent men!)

*** You don't need to train constantly to become a master of this system!** The SEALS, the cops, the agents... *none* of them have time to waste in training. Yet they feel confident using Paul's system even after a *single lesson!* (As you will, too!)

*** Plus, just as importantly, there is no formality, no religious nonsense or bowing or wearing odd uniforms in this system!** It is *not* martial arts — it is a simplified

fighting system that goes *beyond* the street-smarts any martial art could ever offer you!

So how did Paul come up with this amazing fighting system? First of all, he's very well-known in the martial art field. He studied with the legendary Dan Ionsanto — original partner of martial art film star Bruce Lee ("Enter The Dragon") in the art of Jeet Kune Do. You probably haven't heard of this strange fighting art, but nearly every karate magazine devotes dozens of pages to it. It isn't really an ancient art in itself, like Kenpo or Kung Fu — instead, this Jeet Kune Do is sort of a "greatest hits" method of all the best parts of *all* the martial arts. Bruce and Dan and Paul have been copied (mostly unsuccessfully) by thousands of "wannabe" martial art experts. Yet only Paul "walks the walk" of a true seasoned street-fighter, and is absolutely *idolized* by the "karate crowd" for his warrior life-style.

Paul — who is the internationally-acknowledged master of Jeet Kune Do, and considered the man who went on where the more famous Bruce Lee left off — had *only one rule* when choosing the moves he would incorporate into his "simplified" hand- to-hand system:

It Had To Work 100% Of The Time In Actual Street Fights... Where There Are No Rules!

Paul has proved, over and over again with his own blood (and life) on the line, that his basic system can help anyone defeat even the most brutal, huge and insane street fighter in hand-to-hand combat.

It's not a game to Paul. It's not a game for the soldiers and cops who have to use his system to save their lives. And it won't be a game for you, once you've seen for yourself how easily you can incorporate this amazing system into your own life.

Listen: In spite of his efficiency at fighting, Paul Vunak is one of the most compassionate men I've ever met. And he absolutely agrees with me that it's a crime so many good people are walking around afraid in their own neighborhoods — afraid of being attacked, afraid that their girlfriends or wives and kids will be assaulted, or kidnapped, or worse. Paul has a lot of people close to him; he knows what it's like to fear for the safety of loved ones.

That's why he has volunteered to bring his basic fighting system to the public. You should know that he is taking an *enormous risk* in doing this — his job with the Navy SEALS is important to him...

But Paul doesn't care. He knows his simplified system will absolutely mean the difference between life and death for a lot of people who need it — people, like you...

Who Still Remember When A Civilized Man Was Responsible For His Own Safety!

Paul has just one serious request. He wants every precaution taken to keep this important fighting system out of the hands of felons and "suspicious" types. And that's my job — that's why I'm being almost overly-paranoid about who I let see this stuff. As much as is humanly possible, I intend to keep this away

from the criminals out there... while at the same time giving the advantages this system offers to as many of the "good" people as I can reach. But, honestly, I don't know how long I will be allowed to offer Paul's system.

I Don't Want Any More "Good Guys" Hurt Because They Didn't Have Any Of These Simple Street Fighting Skills!

At first we were planning to go from city to city doing seminars, spreading a slow wake of confidence among people as we traveled. But that would take too long, and in the end we still wouldn't reach everyone who needs this crucial survival information. No — we had to find a way to get this stuff into the hands of every deserving person *as quickly as we could.*

What we did was, I think, brilliant. We decided to *video-tape* an entire "teaching course" with Paul, and get it to a pre-selected number of people through the mail, all at once. Believe me, this is no ordinary video — instead, it's a genuine **breakthrough** in training technique... even better than what many of the cops and soldiers got during their own initial training!

Here's what you get: Paul Vunak went into a San Diego film studio for a week and allowed us to produce the most incredible video package you've ever seen. We were able to take that week's worth of shooting and "distill" it down to just *one* video — that's how simple Paul's system is. This single video is all you'll need to be able to learn (and master) his entire basic "simplified" hand-to-hand street fighting system!

This is the most intense and enlightening hour you'll spend in front of a T.V.! We spent months of preparation for the shoot, and spent about ten times more money in production than we'd planned on — but we're not complaining. This video surpasses all of our wildest dreams. You see, we've all seen about a thousand of the *other* videos out there — you can pick up any martial art magazine and see twenty ads a month for the latest fad among karate "experts". But they're all a huge waste of time, shot with "Uncle Ernie's" hand-held camcorder and without a second thought given to **teaching** you anything. All you get is a long, boring home video of a guy showing off his air punches and spinning kicks, or of some weird seminar where you had to *be there* to get anything of value.

We went the *other* way — using **3 cameras** on Paul and the action at all times. So you get the *best* shot to see what's happening, then get it again from a different angle... and then get it *again* in slow motion, with everything described and broken down into its simplest and most easily-learned form.

The way we shot this video...

You Might As Well Be In The Same Room With Paul, Getting "Inside" Advice And A Dissection Of Moves Most Soldiers Never See During Training!

Paul has absolutely dedicated himself to teaching you *everything* you need to know... and to do it so you can come away from your **first viewing** with enough powerful know-how and new skills to increase your naturally fighting ability by 200%...

instantly! This is the equivalent of having 8 personal, super-intense lessons all recorded just for you... by the most *respected* hand-to-hand fighter on the planet!

Even better, Paul took the time to show you clear (and exciting) **real-life examples** of how to handle situations in a crowded bar, in a recreation room, and in the street. These "extra" situational learning tools remove any doubt you may have as to how to use your new skill in the real world.

→ **You'll learn** how to handle two attackers at once — with a one-two natural him-to-him-back-to-him-and-out of danger move

"...the SEALS love Paul's system. It incorporates real-life fighting tools no other system has; yet it can be mastered in an astonishingly short time."

that allows your body to act the way it *naturally* wants to.

→ **You'll learn** the difference between easily-applied "shock" moves, which set up an attacker for you to finish off when you choose to, and even-simpler "clincher" moves — the ones that will *instantly* end any fight the second you deliver them.

→ **You'll learn** exactly why the "joint manipulation" and difficult kicks of most martial arts don't work in real life situations — and why, once you know the simple moves of instantly ending a fight anyway, you don't even *need* to know anything else! (A veteran cop once told me how sad it always is to see the rookies fresh out of the academy try to use their fancy karate moves on a drug-crazed maniac or a drunk bully — only to get their heads cracked open while the criminal gets away, laughing. That's why the veteran is so happy he learned the **real** way to end any fight from Paul.)

And, of course, you'll also learn the main secret of this system's popularity with professional soldiers: it's easily learned, easily remembered, and most importantly, easily *used*.

Here's what else you'll discover in this amazing video:

* The single most important move you can make in any altercation — it's what your body *wants* to do, but what *most* people panic about and refuse to allow themselves to do! (Yet it will save your life!)

* **How to use a simple "cat-like" move to instantly position yourself to deliver the easiest knock-out blow imaginable — a strike so natural your grandmother could pull it off against Mike Tyson!**

* How to instantly "shut down" an attacker's testosterone levels, using your body's own built-in "brick". (Even a 90 lb. woman possesses this amazing rock-hard weapon!)

* **Why hitting anyone with your fist is silly (even trained boxers bust knuckles that way)... and how to use the 8 "natural weapons" of your body to deliver 5 times the power of a fist with *half* the risk of injuring yourself!**

* When to use the most *simple* strike you'll ever learn... an unstoppable natural move so effective in ending fights that it's not allowed in full-contact karate tournaments! (Instant disqualification — it's also a move that 99% of the most brutal street fighters you'll ever encounter have **never seen before...** and *don't know how to defend against!*)

* **How to use the "hip-swinging secret" soldiers use to drop opponents instantly — no speed or strength required, yet it's like driving a 160 lb. bar of lead into the bad guy's belly! (It's so effective, you don't even have to come close to hitting your**

"target" area... even the sloppiest attempt by you will bring him to his knees!)

* How to effortlessly "parlay" the same natural force that has ended more professional football players careers than any other... it's a human's weakest point during a fight (or before a fight begins), and once you know about it you've just increased your ability to defeat a larger man by **200%**!

* **How to use a super-effective, completely unexpected technique straight out of the "Three Stooges" to cause any attacker to automatically (1) back up, (2) raise his hands in defense, and (3) blink rapidly... all of which instantaneously reverses the tables and makes your attacker suddenly vulnerable to a fight-ending blow you can deliver in your own sweet time.**

* Why all elite soldiers are given "permission" to use the one street fighter's Secret Weapon we are all taught from kindergarten *not* to use... and how you **can** use it to quickly remove yourself from any situation where you have been surprised from behind!

* **How to use the *other* "dirty" street-fighting tool not allowed in any civilized boxing or karate match... because of it's immediate ability to disorientate and topple your opponent! (It *also* works when you do it incorrectly!)**

And more! Don't let the idea that a system with "only" 8 basic moves must be too simple to work, either — this isn't theory, this is the result of a lifetime of experimentation in blood! Everything Paul teaches you was perfected either in the street, or on the battlefield... where it had to work, or good men would die.

Listen to what these experts have to say:

"There's no flare, no garbage, no ceremonial nonsense, no magic. Paul can spend 15 minutes with anyone and make you twice the fighter you were before!" — **Shane Brott**, Black Belt Martial Arts Instructor

"Finally, after 23 years of karate and other martial art styles (including military training), I found a system that works in the real world! Paul, where were you 20 years ago?" — **Paul Iwamoto**, Chicago

"Thanks for a video that the ordinary person who works for a living can actually learn from! I am passing these simple and effective tools along to my wife and children." — **Rick Manente**, Los Angeles

"Street Safe is the most effective self defense system I have ever come across." — **CA Narcotics Task Force Commander**, (Name withheld due to security regulations.)

"This (Street Safe) will probably turn the Martial Arts community on its ear... BRAVO Paul." — **Jim Hinesly**, SWAT Team Member, Hostage Negotiator, and member of Sheriff's Tactical Team.

Actual SEAL team members are not allowed (by strict Navy regulations) to comment, but in private conversations with me they have said that Paul Vunak's training system has provided them with the most realistic training they've ever had, going back 20 years!

"Paul has one advantage nobody else has — actual experience in street fighting. Having been in it, he can teach you how to not only survive, but win, even if you aren't experienced in the street." — **Rich Chen**, Hawaiian ex-street-fighter

"Listen: Any citizen who leaves the safety of themselves or their family in the hands of any organization, including your local police department, is in for trouble! We all need to take responsibility for our own well being. I feel this video tape will give anybody who watches it immediate tools in self-defense principles that will make you confident. And anyone from the age of 13 to 80 can use these tools!"

— **Sgt. Carlos Hernandez**, South Florida Police Tactics Instructor

That last quote sure puts things in perspective, doesn't it? That's a *police officer* talking — telling you the days of relying on your local cops for protection are long gone!

Let me tell you something you already know in your heart...

As A Man, It's More Important Than Ever Before To Know How To Defend Yourself!

And, when your family and loved ones are at risk, you need to know how to take out aggressors with **absolute certainty**. Watching Sly Stallone and John Wayne deliver movie-magic roundhouse punches doesn't cut it.

You have a **duty**, as a man, to protect yourself and loved ones *like* a man. And no amount of philosophical nonsense is ever going to change that fact.

You've seen the headlines — rape is up, assault and murder doesn't even make the front page anymore, and robbers are shooting people even **after** they give up their watches and money (it's a trend the police call "Thrill Killing"). Heck, there are jerks hurting people without *any reason at all!* The rules are gone. You could be attacked inside your home, in the back aisles of a supermarket or theater, waiting in your car at a light, anywhere, anytime, by a growing mob of remorseless scum who *enjoy* demolishing innocent people's health and lives.

But they aren't going to enjoy coming up on you, friend. Not anymore.

It's Time To Stop Being A Victim, And Learn To Walk Your Streets With Confidence!

Look, I know you don't want to turn into some hardened, mean-eyed killer. That's not what Paul's video is about. But do not doubt that the newfound confidence this information gives you will "leak" into every area of your life. I've seen it happen a thousand times...

- ◆ You'll "carry" yourself in a new way that just says "Don't mess with this guy."
- ◆ People will be extremely pleased to see you smile and be nice to them... and will go far out of their way to be extra nice to you, automatically.
- ◆ Have you ever seen how people treat a man like Sean Connery or Joe Montana when they enter a room? It's not just that they're good-looking... more, it's that these men *reek* of confidence and the lack of fear. You can have that, too.
- ◆ Plus, it has to be mentioned: There's an undeniable *sexual attractiveness* to any man who knows how to look the world in the eye and not flinch. You can't fake it — it's a primal, animal part of us, and when it's there it shines like a searchlight in your eyes.

Now, let's be straight about something here: This is not a magic potion you take to become invulnerable. Use this system only at your own risk, and take responsibility all the way down the line for your actions. You can understand why I have to tell you this — we've gone to an enormous amount of trouble and risk to bring this material to you. We're not talking about playing games here; this is real life. Used correctly, Paul's basic system is without doubt your best first-line defense in a tight spot. You'll be able to "parlay" your learning into a few simple moves that will take down a man twice your size, even as he's assaulting you — and even if he has 10 years of martial arts experience, or a lifetime of street-fighting under his belt! This stuff is that effective.

But it's not fool-proof. Don't be a fool, and for God's sake don't go looking for trouble. That's not what this video is about.

That said, you should know that you will take **absolutely no financial risk** in ordering this video! It could not be simpler for you to get this video, watch it at your leisure, and decide in your own sweet time whether it's everything we have told you it is. In fact, you get an almost ridiculously-generous...

100% No-Questions-Asked Money-Back Guarantee!

If you aren't convinced, after owning this video for **3 entire months**, that it's the real thing, just send it back to us for a complete refund of your purchase price. You'll get no hassle from me or anyone else... in fact, I will *personally* make sure you are sent your refund by return mail. Heck, you don't even need a reason to send it back — I trust your judgement. Like I said, I'm just trying to get this info into the hands of as many "good guys" as I can... *while I can*.

Here's how to order: We've set up a special phone line for you — all you need to do is call **1-800-899-8153** and tell the person who answers you want the "Street Safe Code 74-D" video package, and use your credit card. That's a toll-free call, and won't cost you a cent. Or, you can fill out the special Order Form below and mail it with your check to:

**Tactical Response Solutions
2945 S. Mooney Blvd. • Dept. 74-D
Visalia, CA 93277**

That's all there is to it — and when you use your special "code", your video will be *shipped out by return mail!* The price for this video is dirt-cheap, too — in fact, at just \$67 plus \$2 shipping and handling (total: \$69), it's less than you'd pay for *one* lousy personal lesson in most karate schools... where at *most* you'd learn how to bow and assume some silly stance that will fool no one!

This really *is* a great offer — because it's the real thing, because your life will change immediately for the better... and because you risk *nothing* by giving the video a "test run" on your own T.V. set.

Don't put this off — remember, there's a very real and very serious chance this information won't be allowed out to the public for very long! And if you don't order right away, you may never see this offer again, ever. Don't let that happen — you stand to lose *nothing*, and yet what you can **gain** is more important to living well in this world than any other skill you'll ever learn!

Sincerely,



R. L. Horine
President, T.R.S.

P.S. One thing — It's *very* important. I have a few copies here of a hot new special report, and I want to send it to you, absolutely **FREE**. It's called *Close Quarters Gun Disarmament*, and it's written by Randy Wanner, chief instructor at a national institute that *exclusively* teaches FBI, DEA, SWAT and other specialized units... but never civilians! In fact, **this report was never intended for civilian eyes** — Randy has only agreed to let me give this to carefully selected people who have been cleared to receive our *Street Safe* video.

The information in this hot report has **already saved the lives of officers on duty** — it's a revolutionary technique that allows you a 91% chance of disarming an assailant without getting shot... and with the increase in armed robbery in the U.S., *where people are shot even when they cooperate*, this report could absolutely save your life.

It's yours **FREE** when you get the video... and you can **KEEP** it even if you decide later to return the video package!

P.P.S. Hold on — *we're not through yet!* I've just been informed that Paul Yunak finally agreed to let us film several sessions of his special **Invitation-Only Advanced Class...** and offer the video tape of this "insider's look" **FREE** when you order **STREET SAFE** within the next 11 days. (This is incredible stuff!) Paul gives these "closed door" classes to select students, always late at night, and they are always filled with SEALS, Marines, SWAT team leaders and other agents who insist on remaining anonymous — the room is almost a "Who's Who" of dangerous soldiers and famous fighters. This video tape is over an hour long, and will take you above and beyond the knowledge you get from **STREET SAFE**... it's a "**master's graduate course**" for experienced fighters! The tape is live, *raw* (a little bloody, too), but absolutely "must-see" material for anyone who wants to learn how the "big boys" hone their skills to perfection. It will **never** be offered to the public for *any* price... but this exciting video-taped look into the **real world of training soldiers** is yours **FREE** when you order **STREET SAFE** now. (And make sure you watch this new tape *closely* — you won't believe some of the "tricks" you'll pick up as these guys tear into each other!) This **extra bonus** is *also* yours to *keep*, as our gift, even if you decide to return the main package!

For The Fastest Service Use Your Credit Card And Call Toll-FREE

1-800-899-8153 (Ask For Department 74-D)

Priority Order Form For SOLDIER OF FORTUNE Readers Only!

YES! I want to take advantage of this incredible opportunity while it's still available... I'm ready to take responsibility for my own safety and the safety of my family! I understand I have an overly-generous **3-Month No Questions Asked 100% Guarantee**: If after viewing this video for three months, I am unsatisfied for any reason at all, I can simply return it for a **full refund** of my purchase price. That means I can decide for myself if this really is the most amazing self-defense self-taught course ever created. It's a fabulous deal, and I don't risk a dime by ordering! So please, rush it to me by return mail!

→ _____ By initialing this line, I am stating that I am over 18 years of age and that I have never been convicted of a felony. I also state that I will use the information contained in Street Safe in a defensive situation only. I accept sole responsibility for my actions as an adult.

I prefer to pay by credit card. Please charge my:
 Visa MasterCard American Express Discover

Enclosed is my check (payable to TRS), for \$69.
Please rush my *Street Safe* video to:

Card #: _____ Name: _____

Expires: _____ Address: _____

Signature _____ City: _____ ST: _____ Zip: _____

Tactical Response Solutions • 2945 S. Mooney Blvd. Dept. 74-D • Visalia, CA 93277

CA & VA residents add appropriate sales tax. Rush shipping available for additional charges of \$10 for "2-Day" shipping and \$15 for "Overnight" shipping.

SECOND AMENDMENT O.P.

Doctors, Lawyers, Guns & Money

by Dr. Edgar A. Suter

To unravel entanglements it is most often fruitful to "follow the money." The small minority of professionals who are members of the American Bar Association and the American Medical Association have not yet joined hands in their separate efforts to disarm Americans. Perhaps well-intentioned and misguided, both of these political groups have conflicting interests when dollar signs appear.

For lawyers, the prospect of opening an entirely new front in litigation, suing manufacturers when their products are *misused* by criminals, is expectedly enticing. Can you imagine such a precedent applied to automobiles? Or other consumer products? There would be enormous amounts of money made in filing and defending such actions — and the consumers would pay.

For prohibitionist physicians, financial incentives may be less obvious, although inner city hospitals have experienced budget shortfalls and the prospect of a new source of tax revenues is appealing. Many physicians who advocate gun prohibition have promoted confiscatory taxation and fees on guns, ammunition — and gun owners — proposing, without any embarrassment whatsoever, that those taxes be funneled their way, into their research and their emer-

gency rooms.

To make their case seem stronger than it is, they have completely ignored the 2.5 million American lives protected annually by guns and have exaggerated the medical costs, claiming \$20 billion per year or more in costs from "gun violence."

The *actual* economic cost of medical care for gun violence is approximately \$1.5 billion per year — less than 0.2% of America's \$800 billion annual health care costs. But to exaggerate the costs of gun violence, the new prohibitionists routinely include estimates of "lost productivity" or "years of productive life lost" — assuming that gangsters, drug dealers, and rapists would be as socially productive as teachers, factory workers, and other good Americans — to generate their inflated claims of \$20 billion or more in "costs." One recent study went so far as to claim the "costs" of work lost be-

cause workers might spend time gossiping about gun violence.

Far from being pillars of society, it has been noted that more than two-thirds of gun homicide "victims" are involved with drug trafficking or have evidence of ante-mortem (before death) illicit drug use. In one study, 67% of 1990 homicide "victims" had a criminal record, averaging four arrests for 11 offenses. These active criminals cost society not only untold human suffering, but also an average economic toll of \$400,000 *per criminal per year* before apprehension and \$25,000 *per criminal per year* while in prison.

The advocates of gun prohibition routinely force us to address the question of the "costs" of gun violence, so we are forced to note that the gun deaths of those predators and criminals may actually represent an *economic savings* to society on the order of \$5.4 billion annually —

more than three times the estimated "cost" of guns. Why? Six feet under, with their criminal careers cut short, *those criminals now hurt no one and they cost us nothing further.* And this figure doesn't even take into account that crime victims armed with guns have a lower injury rate than those that are unarmed or armed with other weapons (see chart).

The facts are clear — vicious predators who ignore laws against murder, rape, and drug trafficking routinely overlook gun control laws. There is no magic that will make these predators obey the next gun control law. It is only honest citizens who obey gun laws, so gun control only disarms us victims. Victim disarmament is *not* a policy that saves lives.

Edgar A. Suter, M.D., is national chair for Doctors for Integrity in Research and Public Policy. ✕

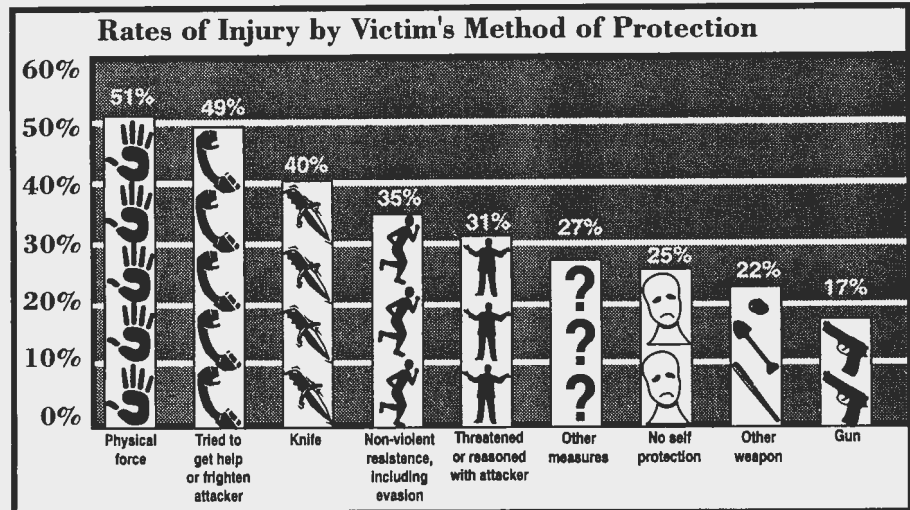

PALADIN PRESS

SECRETS OF STREET SURVIVAL - ISRAELI STYLE

Staying Alive in a Civilian War Zone

by Eugene Sockut

In many parts of the so-called civilized world, the streets have become a war zone, and no one is ever truly safe. Surrounded by enemies on all sides, the Israelis are keenly aware of this. They have made survival a way of life (or death). In this book, Israeli self-defense and small arms specialist Eugene Sockut shares the secrets his people have gleaned from years of prevailing in hostile territory, including such often overlooked areas as the required survival mind-set, the psychology of a mob and how it can be used to survive a riot, the use of dogs for street survival, the viability of the sword as a modern self-defense weapon, a practical, low-cost solution to concealing a gun in your hand while on the street and many other novel tips and "street survival lessons" one could only expect to learn from those who have "seen the wolf and conquered him." *For academic study only.* 5 1/2 x 8 1/2, softcover, photos, illus., 400 pp.

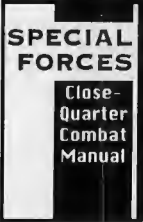
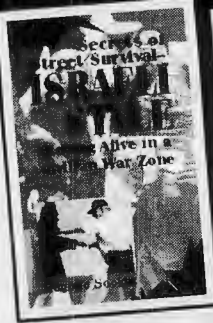

SPECIAL FORCES CLOSE-QUARTER COMBAT MANUAL

This is the actual manual used by SF soldiers to train the ATF assault force that conducted the tragic raid in Waco, Texas. Now you can know how federal troops go about the business of "law enforcement" with full military intent and force. A provocative foreword by reporter Jim Pate probes the ominously changing role of an increasingly heavy-handed ATF. 8 1/2 x 11, softcover, photos, illus., 184 pp., \$25.00

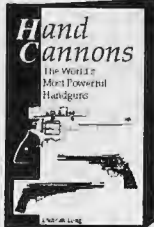

HAND CANNONS

The World's Most Powerful Handguns
by Duncan Long

"Hand cannons" are the biggest, loudest, most powerful handguns in the shooting world, firing cartridges from the famous .44 Magnum up to the mammoth .50 BMG. Duncan Long evaluates these massive pistols and reveals how to tame their recoil and muzzle blast and improve their accuracy. 5 1/2 x 8 1/2, softcover, photos, illus., 208 pp. \$20.00

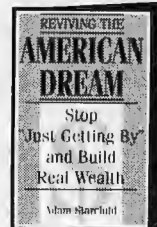

REVIVING THE AMERICAN DREAM

Stop "Just Getting By" and Build Real Wealth
by Adam Starchild

Can you still get a job where you earn what you're worth, find fulfillment and achieve financial freedom? Yes! Entrepreneur Adam Starchild tells you how, not with pie-in-the-sky intangibles but practical, thought-provoking ideas that will help you find "the good life" that the majority of Americans want. 5 1/2 x 8 1/2, softcover, 184 pp. \$14.00

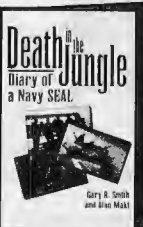

DEATH IN THE JUNGLE

Diary of a Navy SEAL
by Gary R. Smith and Alan Maki

This is the riveting combat diary of Navy SEAL Gary Smith. During his 32 months in Vietnam, he engaged in 257 combat missions. This book is a realistic look at the men, the weapons and the tactics of the guerrilla war fought by Smith and his fellow SEALs in the canals and swamps of Vietnam. Includes 16 pages of never-before-published photos. 5 1/2 x 8 1/2, hardcover, photos, 352 pp. \$29.95



NAVY SEALs

The Men Behind the Legend

This exciting video of all-new action footage features the most famous SEAL commanders of all time and their pivotal roles in the development of the Teams: Doug Fane and the first frogman; Roy Boehm and the guerrillas of Vietnam; Dick Marcinko and his elite counterterrorists; and Tom Katana and the ultramodern SEAL warriors of today. If you see one film on Navy SEALs, this should be it! Color, approx. 70 min., VHS only. \$39.95



CARLOS HATHCOCK: MARINE SNIPER

War Stories and Tactical Tips from the Master Sniper
with Carlos Hathcock

The most accomplished sniper of the Vietnam War and the founder of the U.S.M.C. sniper school tells in his own words how snipers outthink and outshoot their prey. In this entertaining and informative video, Hathcock talks about observation, target selection, shot placement and much more. Color, approx. 55 min., VHS only. \$29.95



HOME WORKSHOP PROTOTYPE FIREARMS

How to Design, Build, and Sell Your Own Small Arms
by Bill Holmes

Master gun maker Bill Holmes shares what will and won't work in designing and building rifles and shotguns from raw materials. Includes the fine points of creating everything from actions to sights, as well as tips on tools, materials, assembly, finishing and more. *For academic study only.* 8 1/2 x 11, softcover, photos, illus., 192 pp. \$25.00

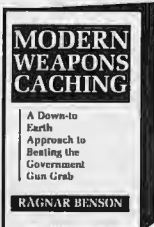

MODERN WEAPONS CACHING

A Down-to-Earth Approach to Beating the Government Gun Grab
by Ragnar Benson

The time to prepare is now. In the race against the firearm roundup in the U.S., gun owners who refuse to give up the freedoms that are their birthright must take their weapons underground—bury them—before it's too late. Ragnar will show you how to do it right. 5 1/2 x 8 1/2, softcover, photos, 104 pp. \$14.00

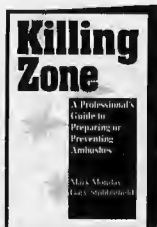

KILLING ZONE

A Professional's Guide to Preparing or Preventing Ambushes
by Mark Monday & Gary Stubblefield

In today's world, knowledge of ambush techniques is vital for bankers, soldiers, businessmen—even tourists. Here, the authors explain in detail how to plan or prevent an ambush, apply ambush techniques to 60+ special situations and analyze 40+ real ambushes to see why they succeeded or failed. 5 1/2 x 8 1/2, softcover, 264 pp. \$25.00



U.S. NAVY SEAL COMBAT MANUAL

One of the rarest FMs in the field of military collecting, with special emphasis on underwater demolition techniques and explosives. Equipment and tactics employed by this elite fighting force are covered, as are SEAL weapons, communications, diving, infiltration and exfiltration, survival and more. 8 1/2 x 11, soft-cover, photos, illus., 240 pp. \$19.95



GET EVEN

The Complete Book of Dirty Tricks
by George Hayduke

A hilarious overview of the methods people use to get even with big business, government and enemies. These dirty tricks range from the simple to the elaborate, including more sophisticated schemes devised by CIA and Mafia members and political dirty tricksters. *For entertainment only.* 5 1/2 x 8 1/2, hardcover, 208 pp. \$19.95



BOOK II - HOW TO GET ANYTHING ON ANYBODY

The Encyclopedia of Personal Surveillance
by Lee Lapin

This long-awaited follow-up to the best-selling first volume is a gold mine of the latest techniques and tricks of intelligence collection. Learn how to bypass computer passwords, look or listen through solid walls, gather personal data on anyone and much more! 8 1/2 x 11, softcover, photos, illus., 232 pp. \$35.00



RED CELL

Secret SEAL "Terrorist" Operations
Here is the controversial story of the U.S. Navy's top-secret SEAL commando unit tasked with testing security at U.S. and NATO bases worldwide. Now for the first time you can see the shocking footage taken by Red Cell during its raids, showing stunning evidence of security lapses that allowed them to breach fences and gates, plant bombs and take Americans hostage. Color, approx. 55 min., VHS only. \$59.95



FUGITIVE

How to Run, Hide, and Survive
by Kenn Abaygo

If you're serious about going on the lam, this book may just save your life. Learn to build an evasion shelter, erect path guards, lose a pack of tracking dogs, enter the "Network" of people willing to assist evaders, apply natural camouflage and utilize primitive first aid skills. This unique manual exposes you to possibilities you never even considered. 5 1/2 x 8 1/2, softcover, 96 pp. \$12.00

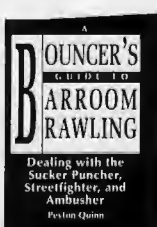

A BOUNCER'S GUIDE TO BARROOM BRAWLING

Dealing with the Sucker Puncher, Streetfighter, and Ambusher
by Peyton Quinn

As a bouncer in a biker bar and a participant in dozens of fights, Peyton Quinn knows the difference between fighting fact and fantasy. The result is a unique guide to self-defense that can save your ass in places where brawling is quick, dirty and very violent. 5 1/2 x 8 1/2, softcover, photos, illus., 264 pp. \$17.95

WANTED

ORIGINAL MANUSCRIPTS ON WEAPONRY, MILITARY SCIENCE, SELF-DEFENSE, PERSONAL FREEDOM AND RELATED SUBJECTS. SEND A COPY OF THE MANUSCRIPT TO: PALADIN PRESS, P.O. BOX 1307, BOULDER, COLORADO 80306.

(Videotapes are nonreturnable. Damaged tapes will be replaced.)

MONEY-BACK GUARANTEE • DEALER INQUIRIES INVITED • RESPONSE CODE: 5DS

OTHER FASCINATING TITLES

REVENGE & HUMOR

Don't Get Mad—Get Even: The Fine Art of Revengemanship.....	\$ 21.95
Make 'em Pay! Ultimate Revenge Techniques from the Master Trickster.....	19.95
Your Revenge is in the Mail.....	9.95
High-Tech Harassment: How to Get Even With Anybody, Anytime	19.95
Forgive? Forget It!.....	19.95
The Joy of Cold Revenge.....	10.00
Get Even: The Video of Dirty Tricks (video).....	19.95
Get Even 2: More Dirty Tricks From the Master of Revenge.....	19.95
The Power of Positive Revenge.....	19.95
Make My Day! Hayduke's Best Revenge Techniques for the Punks in Your Life	19.95
Techniques of Harassment.....	19.95
Care & Feeding of Tenants.....	10.00
Up Yours! Guide to Advanced Revenge Techniques Mad as Hell: A Master Tome of Revengemanship....	19.95
The Revenge Book.....	10.00
Tenant's Revenge: How to Tame Your Landlord.....	9.95
Screw Unto Others: Revenge Tactics For All Occasions.....	19.95

PERSONAL FREEDOM & MONEY

Preemployment Integrity Testing.....	\$ 12.00
The Outlaw Reports.....	25.00
Street-Smart Survival.....	15.00
Financial Investment Expertise: The Complete Guide to Terms, Definitions, and Winning Strategies....	21.95
Flimflam Man: How Con Games Work.....	19.95
Electronic Fund Transfer Systems Fraud.....	15.00
Save Your License.....	14.95
The Armchair Millionaire.....	10.00
Disguise Techniques: Fool All of the People Some of the Time.....	8.00
Credit Mechanic.....	10.00
How to Hide Anything.....	12.00

ESPIONAGE & INVESTIGATIONS

Don't Bug Me: The Latest High-Tech Spy Methods.....	\$ 19.95
How to Avoid Electronic Eavesdropping and Privacy Invasion.....	12.95
Undercover Operations: A Manual for the Private Investigator.....	10.00
Detective's Private Investigation Training Manual....	14.95
Obtaining Your Private Investigator's License.....	10.00
Practical Guide for Private Investigators.....	12.00
How to Investigate by Computer.....	35.00
SpyGame.....	35.00
SOE Secret Operations Manual.....	20.00
Surveillance Countermeasures.....	20.00

WEAPONS

AR-15/M16 Super Systems.....	\$ 19.95
AR-7 Super Systems.....	17.00
The Gatling Gun: 19th Century Machine Gun to 21st Century Vulcan.....	29.95
The AR-15/M16: A Practical Guide.....	16.95
The Ruger .22 Automatic Pistol: Standard/Mark I/Mark II Series.....	12.00
The Combat Shotgun and Submachine Gun: A Special Weapons Analysis.....	19.95
Assault Pistols, Rifles and Submachine Guns	21.95
The Shotgun in Combat.....	10.00
Shooting to Live.....	10.00
Home Workshop Guns for Defense and Resistance: Vol. II, The Handgun.....	14.00
The Complete Book of Combat Handgunning	16.95
Blowguns: The Breath of Death.....	14.00
Streetsweepers: The Complete Book of Combat Shotguns.....	17.95
The Complete AR-15/M16 Sourcebook: What Every Shooter Needs to Know.....	35.00

ACTION CAREERS

Unrepentant Sinner.....	\$ 19.95
Keep 'em Alive.....	12.00
Manual of the Mercenary Soldier: A Guide to Mercenary War, Money and Adventure.....	24.95
Dead Clients Don't Pay.....	12.00
Expatriate's Employment Handbook.....	15.00
Bounty Hunter.....	12.00
Bail Enforcer: The Advanced Bounty Hunter.....	16.95

MILITARY SCIENCE

Night Fighter's Handbook.....	\$ 10.00
Long-Range Patrol Operations: Reconnaissance, Combat, and Special Operations	29.95
Communications Equipment of the German Army: 1933-1945.....	30.00
Radio Equipment of the Third Reich: 1933-1945.....	25.00
SEALS: UDT/SEAL Operations in Vietnam.....	26.95
U.S. Army Special Forces Medical Handbook.....	22.95
Improvised Radio Jamming Techniques	19.95
The Scout.....	10.00
Project Delta: Special Forces Vietnam Recon Manual.....	8.00
Special Forces Handbook.....	10.00
Special Forces Air Operations.....	15.00
Special Forces Waterborne Operations.....	15.00
Special Forces Operational Techniques.....	22.00
Soldiers on Skis: A Pictorial Memoir of the 10th Mountain Division...	50.00

SURVIVAL

Ragnar's Ten Best Traps: And a Few Others that Are Damn Good, Too.....	\$ 10.00
Survivalist's Medicine Chest.....	10.00
Survival: A Manual That Could Save Your Life.....	18.00
The Trapper's Bible: Traps, Snares, and Pathguards.....	8.00
Live Off the Land in the City and Country.....	29.95
Combat Survival.....	21.95
The Good Booze Recipe and Cookbook.....	8.00
Ditch Medicine: Advanced Field Procedures for Emergencies...	25.00
The Survival Retreat: A Total Plan for Retreat Defense.....	8.00

SNIPING

The Complete Book of U.S. Sniping.....	\$ 39.95
The German Sniper: 1914-1945.....	60.00
Modern Sniper Rifles.....	16.95
U.S. Marine Corps Sniping.....	14.95
U.S. Marine Corps Scout/Sniper: World War II and Korea.....	39.95

KNIVES & KNIFE FIGHTING

The Complete Bladesmith: Forging Your Way to Perfection.....	\$ 30.00
Knives, Knife Fighting, & Related Hassles.....	12.00
Randall Made Knives: The History of the Man and the Blades.....	50.00
Switchblade: The Ace of Blades.....	12.00
Winning a Street Knife Fight (video).....	29.95
Surviving a Street Knife Fight (video).....	29.95

SELF-DEFENSE

Commando Fighting Techniques.....	\$ 12.00
The Death Dealer's Manual.....	12.00
Principles of Personal Defense.....	10.00
Get Tough.....	19.95
No Second Chance! Disarming the Armed Assailant.....	14.00
Violence, Blunders, and Fractured Jaws: Advanced Awareness Techniques and Street Etiquette.....	22.95
Fight for Your Life! The Secrets of Street Fighting....	10.00
101 Sucker Punches.....	10.00
Pool Cues, Beer Bottles, and Baseball Bats.....	12.00

COMBAT SHOOTING

Handgun Stopping Power: The Definitive Study....	\$ 39.95
Instinct Combat Shooting.....	12.00
How to Become a Master Handgunner: The Mechanics of X-Court Shooting.....	10.00
Quick or Dead.....	25.00
Handgun Muzzle Flash Tests: How Police Cartridges Compare.....	20.00

POLICE SCIENCE

SWAT Training and Employment.....	\$ 14.00
Streetwork: The Way to Police Officer Safety and Survival.....	19.95
D.E.A. Narcotics Investigator's Manual.....	50.00
Crime Scene Search and Physical Evidence Handbook.....	16.00
The S.W.A.T. Team Manual.....	20.00
S.W.A.T. Tactics.....	12.00
Mug Shots.....	16.00
Gangs USA.....	24.95
Decoy Ops: Fighting Street Crime Undercover.....	15.95
Death Investigator's Handbook: A Field Guide to Crime Scene Processing, Forensic Evaluations, and Investigative Techniques.....	40.00
Kill or Get Killed.....	29.95
Street Cop: Innovative Tactics for Taking Back the Streets.....	20.00
Riot Control: Materiel and Techniques.....	29.95
Police Crowd Control: Risk-Reduction Strategies for Law Enforcement.....	16.00



PALADIN PRESS
P.O. BOX 1307-5DS
BOULDER, CO 80306



CREDIT CARD ORDERS CALL TOLL FREE 1-800-392-2400
Call 24 hours a day, 7 days a week. Send \$2.00 for 64-page
CATALOG of over 600 titles (free with order).

PLEASE SEND ME THE FOLLOWING TITLES:

RESPONSE CODE: 5DS

CHECK/MONEY ORDER VISA MASTERCARD DISCOVER

CARD# _____ EXP. _____

SUBTOTAL _____

NAME _____

PLEASE INCLUDE
POSTAGE & HANDLING \$ 4.00

ADDRESS _____

CITY _____ STATE _____ ZIP _____

TOTAL _____

Fatal Subtraction

by Peter G. Kokalis

The "cyclic rate" of a machine gun is defined as the theoretical maximum rate of fire of the weapon operated continuously with an infinite supply of ammunition, disregarding the requirement to change magazines or belts. It is always expressed in rounds per minute (rpm).

A wide range of factors affect a machine gun's cyclic rate. Some of the most important are the method of operation (gas, long or short recoil, retarded or unlocked blowback), the mass of the reciprocating parts, the length of the hammer's arc of travel (or stroke), port pressure (in gas-operated weapons), ammunition, fouling, buffers, recoil springs, magazine stripping pressure, belt load, atmospheric conditions and lubrication.

Cyclic rates on blowback-operated submachine guns can be adjusted somewhat by increasing or decreasing the mass of the bolt group. Few know that the Heckler & Koch MP5 bolt carrier contains 32.5 grams of tungsten granules. While primarily installed as an "anti-bounce" device to prevent firing out of battery, this does serve to moderately lower the MP5's cyclic rate as well.

What is the proper rate of fire for a machine gun? That depends on a wide range of factors. Aircraft machine guns generally feature cyclic rates that are much higher than

those employed by the infantry, simply because their firing platforms and targets move faster. Shoulder-mounted weapons usually require different cyclic rates than machine guns fired from bipods or sandbagged tripods. Even culture and tradition play roles in this decision. American and British light and medium machine guns of the World War II era all operated at about 550 rpm. The German MG34 and MG42 GPMGs of this same era fired at much higher rates, 800 to 900 and 1,200 to 1,350 rpm, respectively. German gunners were trained to let off of the trigger quickly and it was believed these higher rates of fire were more effective for the anti-aircraft role.

Many believe that a cyclic rate of 550 to 650 is ideal for shoulder-mounted, pistol-caliber submachine guns because it permits operators to fire two- or three-shot bursts with a minimum of training and with good hit probability. In my personal experience, the upper limit of controllability with weapons of this type is about 875 rpm. That happens to be the rate of fire of the MP5 with fairly "hot" ammunition. At that rate of fire, experienced operators can still consistently fire two-shot bursts with the standard "SEF" trigger pack, which has no

burst control mechanism.

When you start to go above 900 rpm, the operator's ability to fire consistent two-shot bursts goes down, as does the hit probability. However, when you combine a hyper-cyclic rate of 2,200 rpm, or greater, with a burst control mechanism, the hit probability goes up dramatically because the third shot in the group has already left the barrel before the muzzle begins to

"sear conversions" always result in a cyclic rate of 1,200 to 1,300 rpm — much too high.

Worse yet, all too frequently these drop-in auto-sear conversions also exhibit a potentially dangerous phenomenon referred to as "sear bump." The auto sear is located at the forward end of a standard MP5 SEF trigger pack. Registered drop-in auto sears are installed to the rear of the HK94/



This MP5K-PDW drop-in auto-sear conversion had an undesirably high cyclic rate of 1,200 to 1,300 rpm until installation of an Action Hobbies hammer dropped it to a more controllable average of 868 rpm. Photo: P. Kokalis

rise. Examples are the H&K VP70 machine pistol and their caseless ammunition G11 rifle.

Bullet hose cyclic rates plague many of the H&K HK94s and SP89s converted to MP5 or MP5K-PDW configurations by means of so-called drop-in auto sears. The use of the term "drop-in" is an unfortunate misnomer as these NFA-registered components do not simply drop into the receiver. They must be installed by a competent gunsmith. Even then, these

SP89 trigger pack in the semiautomatic hole. This shortens the hammer's stroke (the arc it describes as it travels from the cocked position to impact on the firing pin), with a resultant increase in the cyclic rate, and will often cause the sear to be "bumped" forward so that it does not engage its notch on the hammer. When this happens the gun will stop firing, but since nothing is holding the hammer rearward the slightest jarring movement will cause an acci-

GIANT Heavy Duty 4-Man Inflatable Boat

With OUTBOARD MOTOR

\$167

CALL FREE 7 DAYS A WEEK

As part of an advertising test, *United Pacific Freight* will send the above boat and motor to anyone who reads and responds to this test within the next 30 days. All boats are brand new, packed in original shipping cartons. Constructed of double thick, hi-density fabric, (Lot-Z 26), resistant to abrasion, sunlight, salt & oil. Four separate air chambers for extra safety, with self locking safety valves, oar locks bow lifting & towing handle and is approximately 9 1/2' long. All boats are recommended for ocean and fresh water. Limited quantity. First come, first served - **LIMIT** - 3 boats per address (no exceptions). If your order is received within the next 10 days, you will receive **FREE**, a hand/foot inflator/deflator. Add \$9 handling and crating for each boat requested: *United Pacific Freight* pays all shipping. All boats are accompanied with a **LIFETIME GUARANTEE** that they must perform 100% or you may return your boat for a complete refund. Send appropriate sum to: Dept. B-731 *United Pacific Freight*, 16135 Leadwell St., Van Nuys, CA. 91406. For fastest service order by Visa or Master Card.

CALL FREE
1-800-637-6013
Dept. B-731

HAVE YOUR CREDIT CARD READY VISA / MC

ATTENTION IN THE RANKS

It's Here

ELITE FORCE

Elite Force Military Catalog

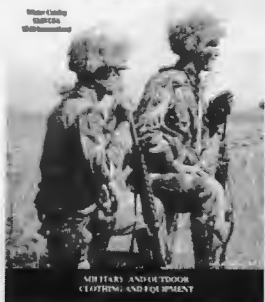

MILITARY AND OUTDOOR
CLOTHING AND EQUIPMENT

YES, The premier military catalog is now available! Over 75 pages of excellent photos featuring "must have" gear as well as items from all over the world, some virtually impossible to get from any other source.

- Survival Gear
- Collectibles
- Hunting Supplies
- Insignia
- Uniforms
- Knives

Send \$3.00 NOW, for your catalog to: *Elite Force, Inc.*™ Dept 200
8809 Running Oak Drive
Raleigh, NC 27613
or charge it to your MC/VISA by calling 1-800-948-0754

dental discharge.

Gary Saia of Action Hobbies (Dept. SOF, 3414 Green Hill Road, Arlington, TX 76014; phone: 817-468-8398), in conjunction with Urbach Precision, has developed an H&K hammer for drop-in auto-sear conversions that corrects these serious problems in a cost-effective manner.

Starting with an H&K G3 rifle hammer, Action Hobbies welds and then reshapes the top of the hammer and cuts the sear notch in a different position. When installed, this will dramatically lower the cyclic rate, prevent "sear bump," provide the locking rollers with more time in the locked position and provide greater firing pin impact on the primer in the semiautomatic mode for more positive ignition (especially important when surplus European ammunition with hard military primer cups is used). These sears are heat-treated for wear resistance. The hammers are drilled for the shank pin and a new pin is installed. The price is only \$79.95, plus COD and shipping charges. These hammers carry a lifetime warranty.

We installed one of these hammers on an MP5K-PDW drop-in auto-sear conversion that had cyclic rates of 1,300 rpm with the MP5K locking piece (No. 16) and 1,200 rpm with an MP5 locking piece. After installation of the Action Hobbies hammer, the cyclic rate (with an MP5 locking piece) dropped to an average of 868 rpm. After 5,000 rounds the Action Hobbies hammer is still performing flawlessly and I can recommend it without qualifications of any kind.

All cyclic rate data were obtained by means of the superb PACT MKIV Championship Timer with its built-in rate of fire feature. Manufactured by Practical Applied Computer Technology Inc. (Dept. SOF, P.O. Box 531525, Grand Prairie, TX 75053, phone: 800-722-8462), the PACT MKIV costs only \$299.95, complete with Mk5 Professional Skyscreens, and will provide accurate data for machine guns with cyclic rates up to 2,000 rpm. The MKIV also serves as an action shooting timer and a highly accurate chronograph. ✕

YOU HAVE NEVER SEEN A CATALOG LIKE THIS!



The 1994 Edge Company Catalog

Over 60 blazing full-color pages of the most incredible knives, action gear, electronics, self-defense, and optics your eyes have ever feasted upon. Now get in on:

- One-Handed Knives
- Night Vision Scopes
- Automatic Air Pistols
- Hunting Knives
- Tear Gas Revolvers
- Locksmithing
- Car Alarms
- Watches, Lighters
- Sword Canes
- Bugging Equipment
- Stun Guns
- Pistol Crossbows
- Samurai Swords
- Tap Detectors
- Stiletos
- Voice Disguisers
- Black Powder Guns
- Spy Equipment

And a thousand more, all with an iron-clad, rock-solid, money back guarantee.

Get Yours Today!

Send \$3.00 for a full 2 year subscription, to:



THE EDGE COMPANY

P.O. Box 826, Dept. SF0495
Brattleboro, VT 05302

Or call toll-free

1-800-732-9976

Please allow a couple of weeks for your first catalog to arrive. Thanks!

PC Assault Rifle

by Gabriel Suarez

The going price for an AR-15 in the People's Republic of California is now about \$3,500!

Many who would rely on such a rifle for defense have found these guns now financially out of reach. Those who got theirs before the ban are concerned about taking such pricey collectors' items into the field, or using such a weapon in a social confrontation where it will likely be taken for evidence with no guarantee of return. In today's political climate, there is also concern how a jury might view the wielder of such an *evil-looking* tool.

But there remains a need for a light, compact, hard-hitting — and innocent-looking — defensive rifle. Such a rifle will likely be stored in semi-readiness, to be grabbed when one expects trouble. It must be light and compact for use in and around urban settings. It must have the capability of handling sudden, close-range (within 150 yards) engagements and use a cartridge that can penetrate the majority of commonly found cover. It must also be able to put a man down with a minimum number of rounds fired.

We've had such weapons for more than 100 years: the Winchester/Marlin/Savage/Browning lever-action rifles.

Carefully consider just what a lone citizen/rifleman requires of his fighting rifle. It must be compact for stowage. It

must be immediately deployable, since engagements usually last only seconds. The citizen/rifleman will probably deal with his problem then withdraw to safety — he will not need to repel human wave attacks. Range is usually less than 150 yards (average engagement distance for police snipers is 75 yards).

The .30-30 Winchester

need, and most can be continually topped off without opening the action. If the shooter follows the "shoot one, load one" concept he is unlikely to run dry. And when the jury weighs your actions they are unlikely to be distracted from the facts by 30-round magazines, black plastic or bayonet lugs. You could say that the lever-action carbine is

matte blued, then added a leather cheekpiece holding six extra rounds for grab-and-go situations. The rifle has Uncle Mike's QD swivel studs, but I generally don't use the sling.

I spent less than \$400, or about one-sixth the cost of a new AR-15. I got 250 rounds of Remington .30-30 170 grain JSP with similar ballistics to the



The Winchester Model 94 rifle design is more than 100 years old, but it can be yesterday's answer to today's problems in situations where modern military-style arms such as this HK-93A2 are too expensive, politically incorrect or otherwise unsuitable. Photos: SOF files

cartridge is suitable for urban penetration and range requirements. Stopping power is adequate. With a 16-inch barrel it is more compact than most military rifles (even with folded stocks). It can be carried "cruiser ready" (empty chamber, full magazine) and be brought into action instantly. It holds as many rounds as one is likely to

(in today's world) the perfect urban rifle: It is the PC *sturmgewehr*.

I obtained a used .30-30 Marlin 336 rifle for about \$200, cut the barrel and magazine tube to 16-1/4 inches and added ghost-ring sights. I kept the original hard rubber buttplate since it was snag- and slip-free. I had the rifle dehorned and

7.62x39mm and tested it vis-a-vis my CAR-15.

I went through the standard rifle drills learned in Jeff Cooper's old rifle school, using a shooting timer and a facsimile of the API camouflage silhouette target. Not surprisingly the lever action kept up with, and some-

Continued on page 74

16th ANNUAL SOF CONVENTION

Sept. 27th-Oct. 1 1995 SANDS HOTEL/CONVENTION CENTER LAS VEGAS, NEVADA

Since 1975 *Soldier of Fortune* has been telling it like it is and fighting the good fight to preserve the constitutional rights of all Americans. Now SOF is pulling out all the stops to celebrate its 20th Anniversary.

And you're invited! Join the staff and your comrades-in-arms for 5 days of fun and good times in Las Vegas. It's more than just a big party, it's also a chance to see, learn and do ...

**Free T-shirt
Exclusively
For Conventioneers**



Early Bird Registration

- Early bird registration \$150. \$175 after Aug. 31.
- First 500 conventioneers will receive a 16th Anniversary commemorative pin.
- Twenty names will be drawn from first 500 conventioneers — winners join Robert K. Brown for brunch.

◆ **PUGIL STICKS** — and other competitive matches. Get in shape now so you can compete for **cash prizes**. Your body will thank you — so might your wallet.

◆ **SEMINARS** — Topics ranging from combat weapon usage to military sitrep reviews, police tactics and survival in modern times. **Learn the truth firsthand from the men who have been there.** Free admission only to registered conventioneers.

◆ **EXPO** — Check out the latest in weaponry, ammo and other merchandise from **over 400 exhibitors**. Runs Friday, Saturday and Sunday. Free admission to registered conventioneers.

◆ **PARTICIPATORY EVENTS** — Receive expert training in a large range of courses including **parachuting & weapons training**.

◆ **THREE-GUN MATCH** — **Prestige and cash prizes** for expert shooters and those who aspire to be (see separate ad in this issue).

◆ **FIREPOWER DEMO** — **An awesome display of firepower** caps off an action-packed day at the range: team shoot-offs, manufacturers' new-product demos, skydiving, big guns & explosives. All day Saturday — free to conventioneers.

◆ **BANQUET** — Saturday night **Awards ceremony** features insightful speakers and savory cuisine. Dress is casual.

◆ **Fast draw paintball contests at poolside every evening.**

◆ **Prize drawings every night poolside on the hour starting at 1900 hrs. — 2200 hrs. Must be present to win.**

1995 SOF CONVENTION PRE-REGISTRATION FORM

- Yes! I want to be a part of the 1995 Convention
 Check or money order enclosed.

Full refund by 7/1/95 Half refund by 8/15/95
No refund after 8/15/95

Charge \$ _____ to my MasterCard Visa

Card # _____ Exp. _____

Signature _____

Name _____

Address _____ Apt.# _____

City _____ State _____ Zip _____

Phone _____

T-Shirt Size S M L XL XXL (circle one)

Mail with Payment to:
SOF '95 Convention Pre-Registration
PO Box 893, Boulder, CO 80306
Tel. 1-800-800-7630 Fax (303) 444-5617





SOFT ON THE GROUND IN CHECHNYA

Russian Spetsnaz soldier moves to engage Chechen T-72 at rail junction outside of Grozny. Contrary to mainstream media reports, these Omon troops were neither ill-equipped nor suffering from morale problems.



At a checkpoint outside of Grozny, Russian security team shows off their AGS-17 grenade launcher and Russian version of *Soldier Of Fortune*.

The road to Grozny wasn't exactly paved head-to-toe with rotting corpses.

Actually — after the first offensive on Chechnya's capital by Russian forces shortly after New Year's



Is Russian Bear Really Getting Bloodied By Civilians?

Text & Photos by Mark H. Milstein

— the road was conveniently lined with budget-rate hookers, thousands of empty bottles of vodka and hundreds of pieces of armor.

I saw them firsthand while rolling out the front gate of the sprawling Russian air force base just outside of

Russians have complete air and ground superiority along supply line from Mozdok to Grozny. Chechens have no operational air units capable of challenging Russian MiGs. And though Chechens have armor, they are hugely outnumbered. Large columns like this one of BMP-2s passed by our position almost nonstop.

Mozdok — a muddy 15 klicks north of the Chechen border — on one of the dozens of mud-caked Russian deuce-and-a-halves that droned their way to the fuel and supply dumps along the 120 kilometers of road to the outskirts of Grozny. This was the Russian army's version of the Red Ball Express and I was glad to be hitching a ride on it.

Before I left, my marching orders from *SOF* were simple. Get as close to the action as possible and get the real story on the fighting in Chechnya. No ifs, ands or buts. So, with a little bit of luck and a handful of Russian-language *SOFs*, my ticket to Grozny should have been written in gold. *Not*.

Just getting from my home in Budapest, Hungary, to Mozdok turned out to be a story in itself. First, I had to deal with closer-than-usual scrutiny of my passport and baggage at the Hungarian-Ukrainian border. "So, comrade, your visa says you're a tourist," the border guard quizzed me. "Why, then, do you need a bulletproof vest with high impact ceramic plates and all that camera equipment?"

Fast talking and a \$50 donation to the local widows and orphans fund got my visa validated, but the real joy, I was about to learn, wouldn't begin until I reached Rostov-on-Don, Russia.

It was there that all my fast talking and smiles — coupled with my inability to convince the Russian border guards that I didn't know how a 26-pound bulletproof vest, two cameras, wads of cash and a map of Chechnya got into my bag — got me arrested and questioned for 12 hours by the local version of Inspector Harry Callahan. The next morning I found myself stuffed on a train bound for Kiev, told never to come back.

My only hope of getting to the Chechnya AO rested on the shoulders of Aeroflot, although that, quite honestly, had me dry heaving all the way to the airport. With my confirmation number and a fax proving I had a pre-paid ticket, I approached the Aeroflot counter at Kiev's Borispol airport and waited for my ticket to appear. Wrong answer.

The ticketing agent, a man who apparently aspired to running an extortion racket in Chicago, proceeded to tell me that it was great that Aeroflot got its money, but in order

for me to board that flight I was going to have to fork over \$150 for his vacation fund or I wasn't flying. Final.

I didn't fly that night.

Two days later, however, after some brainstorming and a little help from friends in Kiev in acquiring a train ticket, I found myself standing on a one-lane road just outside of Mozdok. It only took 10 minutes of being splattered by dirt from the back tires of dozens of BTRs, before Russian army Major Marto Kostya and his truck became my ticket to Chechnya. I don't know why he stopped to pick up anyone loony enough to hitchhike into a war zone, but introducing myself as an *SOF* correspondent went over big. Almost every Russian I ran into had heard of the magazine.

My transportation worries were over. Grozny, full speed ahead.

I knew why I wanted to be in Chechnya, but the question of the hour was, why, after the debacle of Afghanistan, were the Russians charging full-bore into another Islamic republic and invoking the ire of the world?

Russian President Boris Yeltsin's argument is straightforward. The Russian army was sent in to preserve the soft underbelly of the Russian Federation, and make it clear that moves toward independence by other "front-line" states will meet a similar fate.

The Chechen crisis began taking root early last summer after Chechnya and a number of other pseudo-autonomous states brokered an agreement with Moscow to cool down their moves toward independence in return for economic considerations. Every other republic involved in the talks, including Tatarstan, Yakut and Bashkortostan, kept their part of the bargain.

Only Bahamas-sized Chechnya, with its 1.2 million people led by

Dzhokar Dudayev, a former Russian air force general turned Islamic fundamentalist, chose to push the envelope and risk war with Russia. Dudayev's continued call to arms infuriated Yeltsin, who shortly before Christmas called out the dogs and sent in the tanks.

The Russian invasion of Chechnya was supposed to be over in a matter of days. The Russian army, with hundreds of tanks backed by sophisticated air power, should have pushed to Grozny quicker than the average drive to the local Seven-Eleven, had Dudayev cuffed and stuffed and on his way to a Siberian resort and been



Local militiaman fights with Omon Spetsnaz unit in Ishcherskaya. Not all Chechens support Dudayev and his drive to break away from Mother Russia.

out of there before anyone noticed.

Instead, the Russian army has gotten a bloody nose and may well be looking at another prolonged guerrilla war, with Dudayev playing a modern-day Tito and Yeltsin taking a lot of heat and looking at a potential military coup if he doesn't produce a victory.

A series of early invasion blunders by Russian commanders, a few of whom defied orders, coupled with muddled objectives and widespread usage of green troops, have cost Moscow its one shot at snuffing out Dudayev and his few thousand followers quickly.

Chechnya has a centuries-long tradition of organized crime and tribal/clan-like loyalties. And it's those tribal loyalties that have given it the

reputation of being ground zero for producing some of the most powerful and ruthless criminals in the former Soviet Union. These criminal activities have earned Chechnya's fighters a reputation of not giving up without a bloody fight.

Hard Road To Ishcherskaya

As Chechen ack-ack sprayed a nearby, low-flying Russian Mi-8 helicopter, the first trucks of our supply convoy coasted through the machine-gun-shredded remains of two shacks that until a few weeks ago marked the border of the breakaway republic.

Concrete anti-tank barriers lay knocked over and, in one instance, pulverized alongside the two-lane road. We pressed on toward Grozny as Kostya and the driver of his truck, Andre, each brought their AKs up on the seats and pushed open the front windows.

At one checkpoint, guarded by a lone T-72 and eight local policemen, we pulled the trucks over and got briefed on road conditions over the next 50 kilometers to Stanica Chervlenaya, site of the forward-most helicopter base for Russian forces surrounding Grozny.

While Kostya busied himself with logistics, the policemen were acquainting me with Russian hospitality by forcing vodka and cognac into me at a furious rate. "I am a soldier of fortune," one policeman told me in English. "Here, drink some of this," he went on. "It's Russian Pepsi. Actually, it's an old wine. It's Chechen. Drink up."

I did, but a small commotion outside sent everyone grabbing for their weapons and out the door quicker than you can say Joe Stalin. One of the drivers had spotted a small band of "bandits," as the Russian army calls the Chechen rebels, walking

diesel tankers in our convoy received orders to catch up to an armor column, and went their own way. We picked up a commo van near a farmhouse and continued to plod forward.

With total air and ground superiority in the countryside surrounding Grozny, Russian troops were well-supplied and, contrary to mainstream media reports, didn't seem to be suffering from any army-wide strain of bad morale or disciplinary problems.

After six hours on the road, we finally began our way back north and made our final stop in Ishcherskaya, Chechnya, home to a gutted telephone central office and a minor rail junction. We pulled the trucks off the road and were met by Russian Interior Ministry Omon Spetsnaz soldiers who recently secured the area.

Kostya had his men unload a number of sealed crates and two of the other trucks took on cordwood for soldiers in the field to use as fuel for cooking and heating. Another truck unloaded mattresses for the Spetsnaz soldiers.

Spetsnaz Team Special

"Team Special," as their newly sewn-on tabs proclaimed (in English, no less), was all business when I arrived that foggy Monday. At first glance, it seemed I'd walked into a casting call for the bad guy in a James Bond movie. Everyone in a uniform either needed a shave, shower, new teeth or an attitude adjustment. It had been more than a month since their deployment to Chechnya, and the sight of a journalist sniffing around their camp didn't exactly set their hearts aflutter.

After looking each other over for a while, however, the Omon squad at Ishcherskaya came across as being nothing short of well-trained, disciplined professionals ... capable of anything. One of the group opened up by telling me that shortly after securing the first two floors of their barracks — a recently liberated railroad worker's dorm — Chechen "bandits" fired two large-bore mortar rounds into the top floor, collapsed the roof and sent a clear message that a quick victory for the Russians was not in the cards.

"I was in Moscow during the October coup d'etat," said Aleks, the Spetsnaz squad leader. "I was one of



Chechnya is a Bahamas-sized region of 1.2 million people located in the northern Caucasus. It was incorporated into greater Russia in the mid-19th century and possesses substantial oil and mineral wealth.

"I don't like shooting through glass," Kostya said with a smile. "And besides, I can't hear anything with the windows down. This way it's safer."

Although all convoys running the road from Mozdok to Grozny have BTRs riding shotgun, Kostya said he still worries about being ambushed. Indeed, each civilian we passed — man and woman alike — was viewed with cautious eyes. "I'm not coming back dead because I didn't protect myself well enough," Kostya said.

about 500 meters off the side of the road through a field.

Then, in a Russian army version of a "mad minute," three of the policemen opened up with their AKs. They handed me a Kalashnikov to bolster their chances, but I told them I was too sloshed and couldn't hit the side of a barn. The gun was jerked from my vodka-soaked hands and given to someone else.

The bandits scattered and Kostya ordered the trucks to move out. The



Russian tankers took their mission seriously and author's ride on supply truck to outskirts of Grozny went off without problem. Convoy was escorted by several BTRs, and checkpoints along the way had heavier armor.



PK machine gunner and members of tank hunter team stand down after Chechen armor is driven away from their base in Ishcherskaya.

the first Ministry of Interior soldiers into the White House. But our job here is much different. Here we're in charge of maintaining security around this railroad junction and a 10-kilometer stretch of road going in and

out of town."

With Russian armor pouring into an ever-tightening ring around Grozny, control of the rail lines in and out of the republic has become paramount. Days before, Yuri, the



Interior Ministry "Team Special" RPG gunner waits for word from recon party as to whereabouts of Chechen T-72 spotted some 10 minutes earlier.

squad's second officer, said Chechen bandits had taken out a section of track a few kilometers up the road toward Mozdok.

"It's small things like securing rail

Continued on page 83

PROFESSIONAL HOLY WARRIORS

Muj Fanatics Bring Jihad To India

Text & Photos by Mike Winchester

The three-man Indian recoilless gun team moved up behind the wall and loaded. One trooper in helmet and flak jacket climbed the pile of sandbags and gingerly leveled the business end of his Carl Gustav 84mm at an apartment block occupied by suspected guerrillas.

Effective to 1,000 meters with an HE round, hitting an apartment block at 50 meters with this weapon was no challenge. Soon the deafening *crack-boom* sounded, followed by an empty silence as smoke and dust hung in the afternoon air. Then, from within the burning block of apartments, came the defiant rattle of automatic rifle fire — the unmistakable equivalent of a raised finger.

From dead ground across the street, I watched the performance with a clutch of senior Indian brass, including sector Commander Samares Pakrasi of the paramilitary Border Security Force (BSF), the outfit responsible for holding the lid on Srinagar city, capital of Jammu and Kashmir state.

Pakrasi was not having a good day. His response to a tip that he'd hoped would bag a couple of local militants and a weapon or two in a quiet Srinagar suburb was turning into a battalion-sized operation and another public relations foul-up: Nothing like flattening an apartment block in full view of the press for losing hearts and minds.

So far, Pakrasi had one dead and four wounded trying to move beyond the wall toward the block where the separatist guerrillas were holed up. A lightly armed paramilitary force, the BSF is not trained for MOUT (Military



Operations in Urban Terrain). The Carl Gustav team and the other troops moving into position were regular army.

And he was not dealing with locally trained Kashmiri militants, seldom given to enthusiastic acts of martyrdom. *This* was another species, which of late has been making a name for itself in Kashmir: the Afghan vet.

Just how many were actually holed up in the burning building wasn't clear, but they were not about to come out quietly. When the Indians later pulled out the bodies, they found a grand total of two. Neither Pakrasi nor the army commander discussed taking prisoners. With "Afghans"



Kashmiri Hezb-ul-Mujahideen, quintessential rebels with assorted AKs and a Type 69 Chinese copy of the RPG-7, prepare for a night raid.

involved it could only end one way.

The surrounding streets had been evacuated and cordoned the day before, but on the fringes of the cordon it was typical Kashmir: The dividing line between militants and civilians was dangerously uncertain. Watched

Kashmir: Switzerland of the Orient, Lebanon of the Sub-Continent. At 1947 partition, Pak tribesmen invaded Kashmir in support of Muslim uprising, causing Maharaja Hari Singh to accede to India, who flew in troops for first Indo-Pak war. A 1948 cease-fire split Kashmir between India, Pakistan. In 1965 Pak army infiltrators attempted to trigger popular Muslim uprising, causing second Indo-Pak war. In 1971 India intervened in East-West Pak civil war, resulting in formation of Bangladesh. A LOC was established between Indo-Pak-controlled sections of Kashmir, and agreement reached (never implemented) regarding negotiation to settle dispute. Clumsy vote rigging in 1987 fueled popular discontent with New Delhi, and in 1988 Kashmiris went to Pakistan for training in bombing and assassination. Harsh repression in 1990 triggered full-scale revolt, supported by outside sympathizers.



Srinagar rebel poses with new Dragunov sniper rifle. Pakistan's ISI, Afghan and other Muslim sympathizers now supply rebels with training, experienced volunteers, and top-quality arms.

by wary BSF men with SLRs at the ready, bands of youths were congregating, shaking their fists and chanting "Allah Akbar!" (God is great) and "Azaadi! Azaadi!" (Freedom! Freedom!)

Holding Ground, Losing War

That morning had already seen one sniper attack on the BSF cordon. At street level, the BSF and army men know what the politicians and bureaucrats won't — or can't — admit: that in Jammu and Kashmir the battle for hearts and minds was lost four years ago. Most Kashmiris want independence. Some want to join Pakistan. Very few want to stay in India.

Although the Indian military risks lives to only hold ground, in Srinagar



Regular army troops such as these preparing for assault on apartment block are more heavily armed than paramilitary forces, and are being called in more and more frequently.

they're doing it with growing efficiency. In 1990 when the Kashmiri revolt first exploded, most guerrilla factions were urban, and moving with weapons was no problem. Today, thanks to a tight mesh of bunkers, foot patrols and unrelenting cordon and search operations, security forces have managed to reassert control over the city of 800,000. Guerrillas can no longer move freely; caching weapons in quantity risks losing them. All leading separatist factions are now based in rural areas or the mountains surrounding the Vale of Kashmir.

Although three years has brought improvements in the control of Jammu and Kashmir, India has committed nearly 400,000 army and paramilitary forces: two corps commands comprising eight regular army divisions and several independent brigades. Most formations are deployed against Pakistani concentrations across the Line of Control (LOC) dividing the state — disputed between India and Pakistan since the partition of 1947. Some guard the border in Ladakh against Chinese forces in Tibet. But to the irritation of senior army commanders, a growing number are being sucked into the counterinsurgency campaign against a minimum of 10,000 separatist guerrillas backed from beyond the LOC.

The brunt of the world's most intensive counterinsurgency campaign is borne by paramilitary forces, mainly the BSF. Originally formed in 1965 for border control, the BSF now has 56 of its 148 battalions (each about 1,000 strong) tied down in Kashmir, almost all in an internal security role. It's backed by half that number of (federal) Central Reserve Police Force battalions, and a local police force of 30,000. Shot through with sympathy for the militants, the local Kashmiri police are probably more liability than asset.

The conflict has caused the formation of a new unit, under the Defense Ministry, called the Rashtriya

Rifles. Well trained, equipped and counterinsurgency dedicated, five RR battalions have been raised to perform the internal counterinsurgency role that the army is anxious not to play. The Rashtriya Rifles have a good future: Recruitment is underway for 36 more battalions.

One Western diplomat in New Delhi told me, "Things have gotten worse this year. The Indians aren't breaking the back of the militancy and they aren't in a position immediately to end it. It's spreading and both sides are taking heavier casualties."

Phantom Killers

In a taxi my first morning in town, a dull crack rose above the hum of the traffic. "Grenade," muttered the driver as he accelerated past troops scrambling for cover and pulled over.

As I ran back down the streets, shop shutters were rattling down. Nervous BSF men crouched in door-



Armed with Indian copies of the British SLR and Sterling SMGs they obviously don't want to lose, BSF paramilitary troops patrol Srinagar city. Patrols, bunkers and cordon-and-search operations have forced rebels to bases in countryside.

ways, eyes and rifles seeking an invisible enemy. A squad stormed past me, headed the other way — the officer, eyes wild, brandished his pistol. When I reached the scene the bodies had been carried away. A jeep was skewed across the road with a trail of blood, oil and broken glass in its wake. The jeep had stopped briefly outside a shop and as it pulled away, a single grenade was thrown: One soldier was dead, three wounded.

The attacker — man, woman or child — was never even seen. Welcome to Kashmir, Switzerland of the Orient.

Behind the growing conflict, two dynamics are at work. First, the military now has the numbers on the



Indian army regular armed with 84mm Carl Gustav recoilless rifle prepares to blow hole in apartment building where two insurgents are hiding, after lightly armed paramilitary forces couldn't get job done. Although a military success, the op was a public-relations blunder.

ground to go out and crack heads, and it has an intelligence network allowing it to do so. If they haven't broken the back of the insurgency, it's not for want of trying. The gloves are off and young Kashmiris are dying in numbers. By official tally, the security forces have killed more than 4,000 militants. Expect that number to rise sharply over 1995.

But while the Indians have increased pressure, insurgent capability has improved. The reason can be summed in one word guaranteed to make Indian officials wince: Afghanistan. Across much of the Islamic world, Kashmir is emerging as the new jihad, a sword pointed directly at the heart of India — a sword honed in the rugged mountains of Afghanistan.

In 1988, New Delhi still enjoyed its "special relationship" with Moscow, which involved buying quantities

of Soviet arms at "friendship" prices and not criticizing Moscow's misadventures, such as the invasion of Afghanistan. It also meant unstinting diplomatic support for Moscow's placeman in Kabul, President Najibullah.

In summer 1988 as Soviet troops withdrew from Afghanistan, India's then-Prime Minister Rajiv Gandhi expressed concern that a muj victory in Afghanistan would send waves of fundamentalist turbulence across the region. His reading wasn't far off. But what Gandhi didn't know was that it would be New Delhi's own political blunders in Kashmir — the blatant and bitterly resented manipulation of local politics — that were sowing the seeds for this new jihad.

The first blast in the Kashmir struggle came as a bomb exploded in Srinagar in August 1988. By early 1990 New Delhi was looking down the



Smuggled weapons captured from insurgents included this one-man assault team based on an East-German MPIKM that features sound suppressor, BG-15 type 40mm grenade launcher, high capacity RPK-style drum magazine.

barrel of a full-scale revolt in the Vale of Kashmir, armed and supported by its arch-enemy, Pakistan.

The Afghanistan syndrome came to Kashmir in three distinct but overlapping phases, beginning in 1989 and 1990 when the first large numbers of Kashmiri militants began crossing into Pakistan for training. Most courses were provided in camps in both Pakistani-administered "Azad" (Free) Kashmir and in Pakistan proper under the guiding hand of the Inter-Services Intelligence Directorate (ISI), but even then some training was farmed out to Afghan mujahideen chiefs

who had established close logistic and political ties to ISI.

Training for Kashmiris inside Afghanistan — phase one — offered two big bonuses. First and most importantly, muj bases offered both weapons instruction and practical experience on the battlefield. One thing that focuses the mind of a young recruit even more effectively than live-ammunition exercises is the prospect of really getting blown away.

Additionally, Afghanistan offered the Pakistanis a useful degree of deniability. If Kashmiri youths insisted on trekking over the LOC for adventure vacations in Afghanistan, well, that was no business of Pakistan's. This factor was to become increasingly important as Indian diplomatic pressure to have Pakistan declared a "terrorist state" grew. By 1993 the message reaching Islamabad from Western powers was insistent and unambiguous: Back off. Consequently, camps in Pakistan closed down, but across the border in the wilds of muj-controlled Afghanistan it was business as usual — and then some — as training continued unabated.

The second phase in the new jihad was the induction of Afghan muj into

Continued on page 66

There are many factors in the equation that lead to a gunfight's successful conclusion (for you). Needless to say, selecting the correct handgun, holster, a flashlight designed for combat (i.e., a Sure-Fire) and ammunition that will make the largest hole and still penetrate deeply are all important elements. However, no factor is more important than the ability to place your shots, under stress, into the vital areas of your opponent, and that requires extensive periodic training.

Armed professionals, like golf and tennis pros, must continue to receive training from other professionals whenever possible if they are to remain within the constantly changing mainstream of small arms employment techniques. Where can you go, whether you're a member of a military special operations unit, a police officer or just a concerned citizen who wants to improve his skills in managing the type of violent crises that have become ever more prevalent in our society? You go to Gunsite.

Those who have successfully completed the Gunsite 250, 350 and 499 pistol courses can move up to the more challenging Advanced Tactical Problems (ATP) 1 and 2. Structured into an incredibly intense three-day format, when I took this course there was only one level.

Now ATP1 requires Gunsite 250 as a prerequisite, while ATP2 is for graduates of Gunsite 350, 499 or ATP1 only. These courses provide an excellent training format to update tactical skills with a handgun and to exercise problem-solving abilities.

Gunsite's tactical facilities are emphasized and very little time is spent on the square range.

All outdoor firing is on either paper or steel reactive targets. Gunsite's proprietary "option" paper target is

excellent for both handgun and rifle applications. Both green and brown camouflage background patterns are available.

The reactive steel targets used in the pistol drills, called "Pepper Poppers" after their original designer,

Howard Hall, who has spent 12 years with the Department of Energy and is currently a Special Response Team commander at DOE's Los Alamos, New Mexico, facility. Assisting him as a coach was Ed Head, who has spent 17 years with the U.S. Border Patrol and is now a supervisory agent and firearms instructor. These men have all made

their bones and represent a typical cross-section of the Gunsite staff in general.

Two Shots, Twice The Fun

The morning of the first day was spent on the square range bringing all the students back up to speed with Gunsite drills and procedures. We fired head shots at 3 yards and "controlled pairs" at 7 and 10 yards. Whenever possible, you should shoot your opponent twice (except for a shot into the brain cavity). There are several very good reasons for this. First of all, no handgun cartridge provides a guarantee of instant incapacitation, and there is conceivably a synergistic effect from two projectiles striking close together within a very short time frame. (Although, this as yet has

not been demonstrated and would, presumably only serve to increase temporary cavitation.) Secondly, and far more importantly, a bobbing, weaving and twisting human target is a great deal more difficult to hit than a static piece of paper between two posts. Two shots increase our chances of striking the opponent's vital structures.

As the distance to the target increases, a controlled pair of shots, in which two hits are delivered to the targets with deliberate use of the sights before each shot, becomes essential to achieve the level of hit probability required in a gun-

Gunsite's Professional Training

Answers FOR Advanced Tactical Problems

Text & Photos by Peter G. Kokalis



Gunsite ATP student fires from kneeling position behind barricade as instructor times her run through the "Urban Scrambler."

John Pepper, are not self-resetting, as are those used in the Gunsite rifle courses. They come in several sizes, but the ones we fired on were 42 inches high and only 12 inches wide.

Rangemaster for our course was



The "Urban Scrambler" challenges Gunsite ATP students with a timed exercise that involves barricade shooting at 25 yards from seven stations and firing from standing, kneeling and prone positions at an 8-inch steel plate.

fight. The span of time between each shot is short, no longer than necessary for a "front sight, press" sequence.

However, you should never program yourself to instinctively fire two shots every time you bring the front sight onto the target. If you are facing multiple adversaries, taking the time to fire two shots into each one in turn will get you nailed by the last opponent. The drawstroke, Weaver stance and flash front sight picture should all be programmed reflexes. Who you shoot, the number of shots you place on each target and the order in which you engage multiple targets must be a part of the conscious thought processes that result in adaptation and response to different scenarios.

"Failure" drills, formerly known as "Mozambique" drills, are a logical extension of the above techniques. They consist of two shots to the torso, followed by a more deliberate shot to the head. This latter shot is presumably a consequence of the fact that your opponent was wearing body armor. While I think this is a useful exercise, I know of no documented instance in which this technique was actually applied.

These drills were followed by a review of braced kneeling and so-called "California kneeling," in which the shooter faces the target(s) with both knees on the ground. While this latter position can be engaged quickly, it is a tactical technique (as the

shooter can raise or lower his body to take advantage of prevailing cover), not an accuracy enhancer. We then reviewed roll-over prone and the "quick prone" position, which, although less stable than the roll-over prone position, can be employed when only marginal cover is available. Left- and right-side prone positions were also practiced, but at close-range only. This was followed by a marksmanship drill in which the students fired six head shots from 3 yards within five minutes. The winning group was 1 1/16 inches.

After that the students practiced right- and left-hand 90-degree pivots, 180-degree turns, firing while advancing and during tactical withdrawals, shooting on the move and both strong- and weak-hand single-hand shooting. We also practiced the "weapon retention" firing position, a technique used only at extremely close distances. From close-range, we also fired over our heads while lying on our backs. While this may seem far-fetched, you never know when even the most outlandish technique might prove useful.

The morning exercises ended with

tactical and speed reloading drills. A tactical reload, generally performed during a lull (?) in the gunfight, merely brings the handgun back to full capacity, in the unlikely event (in my experience) that your opponent(s) will start firing again. In this maneuver, the replaced magazine is retained by the shooter. Speed reloading, in my opinion designed almost exclusively for IPSC-type competition, provides the shortest possible time interval between the magazine exchange and the resumption of firing. As the presumably empty, or almost empty, magazine is simply dumped on the ground, this type of reload can be accomplished by a trained operator in less than two seconds. A well-executed tactical reload usually takes about six seconds.

Force-On-Force

In the afternoon, we entered the "Funhouse," one at a time, equipped with body armor and face protection as we went up against Rangemaster Howard Hall for force-on-force training using the Canadian-developed Simunitions product. Designed for law enforcement and military training under supervision, Simunitions is a simulated pistol cartridge available in either 9mm Parabellum or .38 Special. To insure safety, the 9mm round can only be used in specially made composite barrels available for a wide



Students moving through the "North Draw" fired at Pepper Poppers dispersed throughout the run and at the end were required to make use of a "battlefield pickup."

range of popular 9mm pistols and the H&K MP5 submachine gun.

The Simunitions round consists of a standard cartridge case, reduced propellant charge and a 27-grain plastic projectile which exits the composite barrel's muzzle at about 400 fps. The projectile is a scored capsule made of a polyethylene-type synthetic and

filled with a pink-colored, non-staining soapy cream that cleans up with soap and water. At 10 yards accuracy is about 1.5 inches of dispersion for a five-shot group. That is more than sufficient for most indoor training scenarios.

There were 10 students in my ATP class, men and women, and they represented an interesting spectrum of occupations and handguns. There was

pistol on the street. From the kneeling position at 15 yards, roll-over prone at 25 yards and in both the outdoor and indoor simulators, I ended up thumb-cocking this handgun during the presentation and before engaging the target. After this experience, I remain more convinced than ever that single-action pistols, such as the M1911 series or the Browning High Power, when carried

bler," which involved barricade shooting at 25 yards from seven stations and firing from standing, kneeling and prone positions at an 8-inch steel plate. The fastest time was 70 seconds.

Moving off the square range, we practiced strong hand and weak hand "Dozier drills." This is a timed exercise. Starting with his back to the target and the weak foot in an automobile tire, on command the shooter pivots 180 degrees and engages five Pepper Poppers. During this time frame, all of the students were also cycled through the "West Wash," an outdoor simulator with Pepper Poppers. All shooting and magazine-changing was single-handed with a disabling device on the weak hand.

Shoot, No-Shoot

After lunch we participated in a discussion on mind-set. This was a prelude to the Funhouse where the students were forced to make decisions and consider the consequences of indiscriminate shooting as we were presented with no



You can expect to find hostile targets at any turn in Gunsite's "Funhouse," including closets.

a physician, a psychologist, a marriage counselor and his wife, two police officers — one from LAPD and the other from the Millcreek PD in Erie, Pennsylvania — the chief financial officer for a group of hospitals, the training and control officer for the New Mexico Military Institute, the worker safety director for a large corporation and myself. This is rather typical of the interesting cross-section you are likely to encounter in any Gunsite course.

The pistols they brought to the course were equally diverse. The LAPD officer used his service Beretta Model 92F. There were two Glock compact Model 19s, an S&W M659, and five .45 ACP Colt-type pistols: a Colt Officers ACP, a Colt Combat Commander, a Novak-tuned Colt M1991A1 and two Gunsite Service Pistols. I decided to use my highly customized caliber .40 S&W SIG P229 along with an experimental crossdraw holster I was testing for Galco. If I have an alternative, I would never carry a double-action

in the "cocked and locked" mode (a round in the chamber, the hammer cocked and the manual safety engaged) by those properly trained to do so, are tactically superior to double-action types.

You will need a minimum of 700 rounds of ammunition for any of the three-day Gunsite ATP courses. I used .40 S&W ammunition provided by Black Hills Ammunition (Dept. SOF, P.O. Box 3090, Rapid City, SD 57709; phone: 605-348-5150, fax: 605-348-9827) loaded with the excellent Hornady XTP 180-grain JHP bullet.

The second day began with the usual square-range warm-up drills at 3, 7 and 10 yards, followed by shooting on the move and an exercise involving the use of pivots called "A Walk in the Park." The pace heated up as we practiced single-hand manipulation, including magazine changes and single-hand shooting at 7 yards.

After that we were all run through a timed exercise, the "Urban Scram-

less than six "no-shoot" targets. When not running through the Funhouse, we were on the square range firing the "gear shift shuffle," which involved two shots at a steel silhouette placed 16 yards away and a single shot at a 10-inch steel plate 60 yards from the shooter. To be successful at this exercise you must shift down from the rapid target acquisition employed on the 16-yard target and take the time required for an absolutely perfect sight picture at the 60-yard plate.

We were also introduced to the Elite 5000 reactive target system at this time. This system's pneumatic target controller can handle up to 15 targets in banks of three. When the exposure time of the first target(s) runs out, the target will disengage and the next target(s) will automatically engage the shooter, creating a domino effect, or chain reaction, with all the targets. No other target system I have ever fired at provided as intense a challenge of the shooter's skill or as much mind-

screaming frustration.

The evening of the second day we reviewed the Harries flashlight tech-

discussion of concealed carry options followed by firing from concealed carry positions. Everyone was also

targets with hostages. During a trip to the Funhouse we fired at advancing and other moving targets. This was, for me, the most realistic indoor simulator exercise I have ever participated in. Finally, as we practiced the drawstroke with our hands in a variety of positions, one by one we traversed the West Wash once again — this time firing and reloading with the weak hand while the strong hand held the disabling device.

Gunsite's three-day ATP courses provide, in my opinion, the most intense and realistic handgun training you can find in an abbreviated time frame. You will fight in the manner in which you have trained. Four wars in the last decade of my life have demonstrated that to me without doubt. At Gunsite you will receive the training required to solve deadly confrontations in the real world in your favor.

For further information on the Gunsite course schedule and the requirements for participation, contact Gunsite Training Center Inc., Dept.



Using one of the training center's trucks, Gunsite ATP students practice a carjacking exercise, firing at moving targets that include hostages.

nique, practiced ambient light shooting, fired at moving targets using flares and witnessed a muzzle flash

moved at a fast pace through the "North Draw" where we were required to make use of a "battlefield



Gunsite ATP student traverses the "West Wash" outdoor simulator, firing and reloading with his strong hand only, while his weak hand holds a disabling device.

demonstration. The evening ended with night runs through the "Donga" and the "Playhouse."

The final day commenced with a

pickup." Using one of the training center's trucks, we all fired a very useful carjacking exercise, first on stationary targets and then moving

SOF, P.O. Box 700, Paulden, AZ 86334; phone: 602-636-4565, fax: 602-636-1236 (after 9 March 1995: 520-636-1236). ✕

By spring of 1992, Tom Posey thought the years of being hounded by his government were over, that his legal battles had ended when the court exonerated him on charges that he violated the Neutrality Act during his efforts aiding the Nicaraguan contras.

Posey headed Civilian Material Assistance (CMA) from 1983 until 1992, shipping civilian supplies to the contra rebels fighting communist troops in Nicaragua. When the

Feds Framed CMA's Tom Posey?

POLITICS OVER PRINCIPLE

by David McElroy

Photos courtesy Tom Posey



Tom Posey, center, with contra leaders Adolfo Calero, left, and his brother, the late Mario Calero, right, at the CMA convention in 1989. Right: Posey caught in red-handed violation of Neutrality Act with a wee Nicaraguan friend who just got a pair of CMA overalls.

Iran-Contra investigations began, Posey's organization came under scrutiny and government prosecutors claimed he had in fact been supplying contra rebels with arms, in addition to clothing and medical supplies.

Posey's wife was actively involved in the organization and has vivid memories of the large loads of clothing that were shipped to Central America. "When Tom was in Vietnam, the kids were what tore him up," Patsy Posey said. "Whenever a child or woman would get hurt, that was the worst for him. Soldiers are expected to get hurt or killed in war, but women and children ended up suffering, too. This was a way he thought he could help out the people down there. We collected lots of clothing for them. I helped sort, wash and dye a lot of clothes."

Because of this Posey was indicted on charges of conspiracy and violating the Neutrality Act in 1987. After

extensive investigation by the FBI and an expensive trial in federal court, a judge ruled there was no reason to think Posey had violated federal law when he and CMA shipped food, clothing and medicine to the contras. Posey regarded the judgment as vindication for doing what he believed was right.

Selling History, Doing Time

Posey, grateful that the ordeal was over, returned to life with his wife and two sons. He began selling World War II and Korean War surplus items at gun shows in the Southeast, mainly as a source of income for his family. Posey sold the surplus items at gun shows in Alabama, Tennessee and Mississippi about five years ago. To him, the items — which were mainly from World War II, Korea and the early Vietnam era — were more than just pieces of moldy LBE. "It was history to me," Posey said. "I felt

like I was trying to help preserve it."

But FBI Special Agent David Heaven let him know that his troubles were just beginning. "He told me in about March or April — sometime in the spring of '92 — that I'd need to watch out because the FBI wanted my ass," Posey said. "I told him to go ahead and try, because I knew I didn't have anything to hide. At the time, I thought he was just being childish. I really thought he was just trying to scare me."

But about 0900 on 16 September 1993 when Posey walked into the post office to check his mail he was surrounded by nine federal agents. "Tom Posey," one of the men said, "you're under arrest."

Less than a year later, Posey entered a federal prison to serve a 24-month sentence on a conviction of

buying and selling stolen military property. Today, Posey still sits in that federal prison in Talladega, Alabama, but he'll tell you that his only crime was disagreeing with the U.S. government. He and his attorney say court documents and testimony clearly show that Posey was a victim of FBI frustration over being unable to convict him for his efforts to help the contras.

It never occurred to Posey that things would turn out this way. A Vietnam veteran, he and his wife, Patsy, have raised two sons during their 27 years of marriage. He coached Little League baseball, has been mayor of the small town where his family lived, worked to help raise money for cerebral palsy and is not bashful about his love of his country.

Posey was charged with conspiracy to steal night-vision goggles. Posey said he had sold some night-vision goggles, primarily at gun shows, but said he had every reason to believe they were legitimate military.



Pallets of CMA-collected clothes, food and medical supplies ready for loading on plane to go south. Feds claimed CMA also shipped weapons but were unable to offer any proof.

Hot NVGs

The goggles proved to be a costly purchase for Posey. In September 1992, a man named Ray Black approached Posey and offered to sell him night-vision goggles. Posey was suspicious about the goggles being available, so he asked a friend who was a National Guard supply officer to check if any goggles had been stolen from the military. The officer had connections with the FBI as well, and he used those connections to check for any reports of stolen goggles. There were no reports on national

crime computers, military or civilian. Posey decided the goggles were legitimate and bought five pairs.

During September and October, Posey bought about 25 of the night-vision goggles, selling them at gun shows and offering them to various police departments. According to Posey, the Florence, Alabama, PD tried out a pair, using them for a stakeout.

In October, there was a report entered on crime computers nationwide — unbeknownst to Posey — about night-vision goggles stolen from the Army in Texas the previous July.

In late fall 1992, Black told Posey he had 200 more pairs of the goggles available. In addition, Black started talking about other weapons that might be available. "I asked to see the end user certificate [from the U.S. Customs Service] for the goggles since he said they were coming from overseas," Posey said. "He never did come up with the certificate, and when he started talking about things

I knew couldn't be legal, I suspected something was wrong. I didn't know whether this man was a thief or if the government was trying to set me up. Either way, I didn't want anything to do with it, so I called Army CID."

CID agent Bob Gravier told him the government was interested in setting up a purchase to learn if the goggles were stolen, so he arranged a purchase. Posey never was told if the goggles had been stolen.

"Bob Gravier testified in court that he was told by the FBI not to tell me whether the goggles were stolen,"



Tom's son, Marty Posey, passes out jewelry, candy, dolls and other morale items to kids in contra refugee camp, 1990. Before his father's bout with the FBI soured him on the idea, Marty was in college studying for a career in law enforcement.

Posey said. "He couldn't tell me anything about it, so since they didn't tell me anything else, I didn't know what to think."

In February of 1993, Black called Posey again with more goggles available. Posey called Gravier again to see if the government had any interest in the new information. "Gravier said they're not interested," Posey said, "so I thought they were OK."

Posey heard nothing else about the goggles or from the government until arrested in the post office: "...all of a sudden eight or nine FBI agents surrounded me and told me I was under arrest," Posey said. "Bob Gravier was with them and I looked at him and said, 'What's going on?' He just kind of shrugged his shoulders, and I could tell from his body language that he just didn't want to be there."

Nabbed, Nailed & Jailed

Posey was charged with conspiracy to buy, sell and transport stolen military property. He went to trial in January 1994. "When I came to trial, the attorney I had at the time did a poor job representing me and the judge did a bad job of letting evidence be presented that had nothing to do with me," Posey notes. "The judge [federal district Judge Truman Hobbs of Montgomery, Alabama] allowed testimony about the man who stole the goggles in the first place to be introduced in my trial. I didn't even know the man — his name was Tim Bolen. Things like that made me look guilty even though I wasn't." Posey said he believes the judge was predisposed

Continued on page 79

Inside Hanoi's Secret Archives

Clandestine Researcher Finds Truth Behind Communist Lies

by F.C. Brown



The Vietnamese previously denied any knowledge of the fate of USAF Capt. John W. Seuell, MIA F-4 pilot shot down in 1972, or his crew mate Maj. James A. Fowler — yet authors uncovered this PAVN photo of Seuell's remains.

As is often the case with subjects of intense national and individual interest, writings on the topic abound, but it can take decades for the definitive book to be written. *Inside Hanoi's Secret Archives* (Simon & Schuster, \$25) is already being hailed by critics as such a "definitive account," one that answers the war's greatest mystery: the fate of our missing men.

Written by veteran journalist Malcolm McConnell, *IHSA* is a masterfully conceived and executed study of the POW/MIA issue, a topic which, despite the passage of more than two decades, remains America's most enduring legacy

of the Vietnam conflict. Encyclopedic in scope, and drawing on exclusive access to classified Vietnamese archives as well as covert American sources, the book reveals in excruciating detail a long pattern of deception and disinformation by the Vietnamese communists to avoid accounting for missing American servicemen.

This epic work deals deftly with an immensely complicated subject. McConnell succeeds in clarifying more than 35 years of complex maneuvers and machinations — in many cases, move by counter-move — on both the American and Vietnamese sides.

IHSA draws on unique sources — including the long-sequestered archives of the People's Army of Vietnam (PAVN) — to investigate every aspect of the emotional MIA mystery. The author spent three years on interviews and research in both America and Vietnam. He is the only writer given complete access to the classified material, both photographs and documents, obtained during Operation Swamp Ranger, the Defense Intelligence Agency's covert mission to penetrate the secret PAVN archives in Hanoi. Operation Swamp Ranger was led by American researcher Ted Schweitzer.

The book contains extensive PAVN combat photographs of American POWs and KIAs never before released to the public, as well as a detailed photographic record of the Hanoi Army Museum collection and archives. These and other exclusive Vietnamese sources elevate the book from a purely American account to one which for the first time includes the Vietnamese perspective of this aspect of the war and its bitter aftermath.

Contrary to conventional wisdom, the author concludes that the Vietnamese communists probably did not hold



Gonzo researcher and master sleuth Ted Schweitzer, here with PAVN Maj. Lai Vinh Mui in the winter of 1993, managed to unlock the archives — and secrets — of the Vietnamese communists.

American prisoners at ransom for the promised \$3.25 billion war reparations from the United States: If they had wanted to use Americans as hostages, as Iran would later do, they would not have released the 110 American civilian contractors, missionaries, aid workers, and intelligence operatives they captured during the final collapse of South Vietnam in 1975.

While the Clinton administration favors restoring diplomatic relations with the Socialist Republic of Vietnam (SRV) because it says Hanoi has given "full cooperation" on resolving the MIA issue, the author documents that Hanoi has not: *Inside Hanoi's Secret Archives* provides proof that the Vietnamese systematically withheld key POW documents from the thousands of records Schweitzer electronically scanned in Hanoi. The SRV has also withheld the secret "Blue Files," the detailed records of all POWs they held. These files are especially sensitive because they contained reports of death under torture, and executions and murder of POWs by ill-disciplined militia and villagers — and the total number of these files is a true indicator of how many live POWs Vietnam actually held.

McConnell's book shows how the SRV inadvertently gave Schweitzer material about MIA cases of which they had previously denied any knowledge. For example, Vietnam has denied for 20 years any knowledge of the fate of Lieutenant Colonel Dean Pogreba, an Air Force pilot shot down near Hanoi in 1965 — but Schweitzer obtained PAVN records of Pogreba's capture as well as his ID card and Geneva Convention card. There are scores of similar cases in the material Schweitzer obtained. A PAVN officer, Colonel Nguyen Van Thi, told Schweitzer that hundreds of American POWs were tortured to death "right here in Hanoi," or near their capture sites.

Although the Vietnamese have consistently refused to admit that any American POWs were transported from Indochina to the former Soviet Union or to other coun-

Continued on page 72

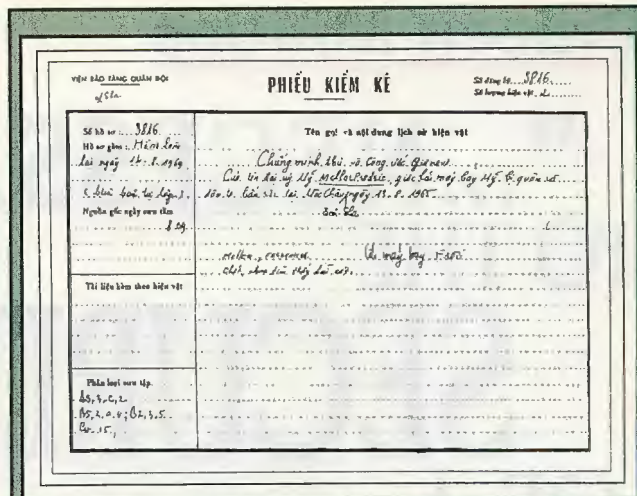

USAF Capt. Frederic M. Mellor, shot down and missing since 1965, is known to have survived the shutdown. He was on the "Last Known Alive Discrepancy List," and the authors discovered his ID card along with its Vietnamese museum acquisition card — proof that the Vietnamese know his fate. His remains have never been returned. Despite such cases, the Clinton administration wants to normalize relations with Vietnam as reward for their "full cooperation" in resolving POW/MIA issues.

Counting the Research Coups

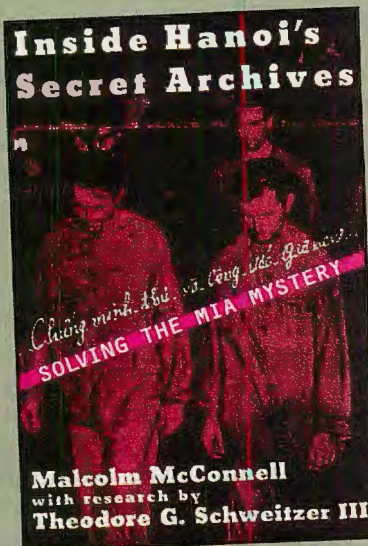

Inside Hanoi's Secret Archives is a mesmerizing work, enlightening on many little-known aspects of the issue, and loaded with fascinating information guaranteed to whet even the most jaded reader's appetite. Among the book's revelations:

- The penetration of sensitive People's Army of Vietnam (PAVN) archives over a three-year period by DIA operative Ted Schweitzer, an expert academic and old Asia hand who operated under the code name "Swamp Ranger."

- The confirmation by a key PAVN source, Col. Thi, that hundreds of American prisoners were, indeed, tortured to death by the communists — as many in the intelligence community suspected all along.

- Confirmation of Hanoi's systematic withholding of sensitive POW files and other material, many dealing with individuals of whom the Vietnamese have consistently denied any knowledge.

- Corroboration of the very real possibility that some Americans were sent to the Soviet Union.

- Unearthing of the existence of the "Blue Files," a set of meticulously detailed personnel records of American POWs, maintained by the Vietnamese.

- Acquisition of dozens of previously unknown photographs from PAVN archives, showing both live and dead American POWs in North Vietnamese hands.

— F. C. B.

Citizen Militias

"...NECESSARY TO THE SECURITY OF A FREE STATE.."

Today there are citizens militia groups active in every state in the union except Hawaii and Delaware. And their numbers are growing daily.

There is no single issue that has triggered this nationwide movement of law-abiding citizens joining militias. Instead, an increasing series of events has convinced even many skeptics that this country is rapidly turning into a police state. A preventative measure against such tyranny lies in citizens militias.

Based on the independent militia companies of 1774, these groups of armed citizens view themselves as a final line of defense against a federal government that, by its actions, has become their enemy. The Second Amendment is at the core of their existence. It is viewed as the last constitutional defense against a government bent on oppression. And with an estimated 200 mil-

lion guns in the United States — the vast majority in civilian hands — there are millions of potential militia members.

Though no exact figure of nationwide membership exists, Larry Pratt, president of Gun Owners of America, wrote over a year ago that he knew of more than 100 *organized* citizen militias. These ranged from the superbly structured Michigan Militia, which alone has 12,000 members, to small networks made up of a dozen like-minded friends.

A major catalyst fueling recruitment is the present administration's swift and successful gun control measures. First, aided by a massive propaganda campaign from Handgun Control Inc., was enactment of

Modern Minutemen Tell Feds: "Don't Tread On Us!"

by Mike Williams

the Brady bill that required law-abiding citizens to undergo background checks and waiting periods to purchase handguns. Close on the heels of the Brady bill was the banning of "19" different types of semiautomatic firearms under the Crime bill's assault weapons provision. After the Crime bill passed, it was revealed that instead of 19 banned weapons, the prohibition actually applied to more than 185 different types of semiauto firearms.

Rumors continue of further measures: a drive to effect a national registration of *all* firearms, and ultimately total disarmament of all citizens. In 1991, at a B'nai B'rith meeting in Fort Lauderdale, Florida, the attorney general of the United States, Janet Reno, stated, "The most effective means of fighting crime in the United States is to outlaw the



Brig. Gen. Carl D. Haggard (shown here wearing colonel's insignia), is local USSF/NM commander in Houston, Texas. USSF/NM is not affiliated with any state citizens militia and does not promote carrying or use of weapons. Photo: courtesy Mike Williams



possession of any type of firearm by the civilian populace.”

Reno’s view of the Second Amendment is echoed by former Eagle Scout and new FBI director, Louis Freeh, who just before passage of the Brady bill trumpeted, “I will vigorously enforce any gun control law passed by the United States Congress.” This statement would indicate that, in Freeh’s view, the FBI had taken over the ATF’s responsibility.

A Government Against Its People

Militiamen often cite the words of John Salter, who was instrumental in filing charges against the federal government during the Randy Weaver siege: “A government which will turn its tanks upon its people, for any reason, is a government with a taste for blood and a thirst for power and must either be smartly rebuked or blindly obeyed in deadly fear.” Militia members’ suspicions were confirmed on 22 August 1992. Special Agent Lon

Michigan militia membership has skyrocketed in light of a parade of gun control legislation passed by the Clinton administration. Wolverines view the Second Amendment as fundamental to a free citizenry. Photo: James McQuaid

Horiuchi, a sniper with the FBI’s Hostage Rescue Team (HRT) fired two aimed rounds from a scoped rifle in the remote woods of Ruby Ridge, Idaho. The first was fired at Randy Weaver and hit him in the right armpit. The second was “allegedly” aimed at 25-year-old Kevin Lee Harris, but instead hit Weaver’s wife Vicki in the head, killing her, before striking and seriously injuring Harris. (See “Standoff In Idaho: The Randy Weaver Incident,” *SOF* March ’93.)

No legal action was taken against Horiuchi and an internal FBI investigation concluded that the murder was a “tragic accident,” the FBI used “improper judgment,” and agents showed “neglect of duty.” Furthermore, the Department of Justice is not pursuing

any criminal actions against Arthur T. Roderick Jr. or Larry Cooper, the U.S. marshals responsible for killing Weaver’s 14-year-old son Sammy and the family dog.

The Weaver case was followed by the ATF combined-arms attack against the Branch Davidians at Mount Carmel, Texas. In April 1993, 85 Davidians were massacred and incinerated by agents of the ATF and FBI. Among those murdered were a large number of children.

There are scores of other documented cases involving outrageous, illegal and murderous actions by federal agents from the FBI, ATF, DEA, INS and U.S. Customs Service against innocent citizens. And *not one* agent from *any* federal agency has been indicted, tried or sentenced for murder. The ACLU and National Rifle Association have appealed to President Clinton to appoint a committee to investigate “lawlessness in law enforcement.” Nothing has been done as of this writing, though hearings on

abuses by federal law enforcement are being considered by a House subcommittee.

Apparently, the FBI and ATF military "wannabes" — witness their jump boots, camo face cream, camouflage uniforms and black ninja suits — are not subject to the same laws that apply to all U.S. citizens. The U.S. Constitution and Bill of Rights appear to be meaningless to these out-of-control stormtroopers.

The foregoing actions have re-

dent signed Presidential Directive 25 in May 1994, which, although secret, is feared to allow subordination of U.S. military forces to a U.N. command. Although nothing new, U.N. troops are trained and quartered on American soil at various military bases across the country. While not necessarily sinister, it makes many patriots nervous.

The government's perceived contempt of its citizens was demonstrated by the immediate passage of the

quired by the U.S. and state constitutions. On the other hand, Oregon has a law prohibiting the formation of militias and Idaho and California have statutes against any paramilitary training by civilians.

Citizens militias feel compelled to distance themselves from state-sponsored organizations. Nationwide, citizens militia members are all volunteers who furnish their own uniforms, weapons, ammunition and equipment. Their ranks include men, women, girls and boys, 16 years and older. With few exceptions, there are no restrictions as to race or religion.

Since citizens militias operate in a legal gray area, many groups are very security conscious — the result of government attempts to infiltrate agents and informants into their ranks — and understandably reluctant to furnish information concerning their unit's Table of Organization and Equipment.

With rare exception, these groups have formed under the broad provisions of the Second Amendment, and in some states, under respective clauses in the state constitutions. In all groups, the volunteers swear an oath to the U.S. Constitution, to protect and defend it against all enemies, foreign and domestic, and to the constitution of their respective states. They all agree to abide by all legal laws: federal, state and local.

A National Militia

On the national level there is the United States Special Field Forces/National Militia (USSF/NM), which operates under the National Defense Act of 1916, recognizing a class of non-enlisted citizens described as "the unorganized militia." A government chartered, non-profit organization created in 1974, it does not depend on



There has been a steadily increasing series of events that have convinced many this country is rapidly turning into a police state. These Wolverines, armed with a variety of assault rifles and hunting weapons, organize to ensure that never happens. Photo: James McQuaid

sulted in a shared belief among militia groups countrywide that the federal government is not their friend, and that its various agencies are ignoring the U.S. Constitution and Bill of Rights. There is reason to fear that federal agents of the FBI and ATF have repeatedly lied, concealed, and in some cases, destroyed evidence in attempts to secure convictions in federal court. And there remains a sinking feeling that some federal judges are answerable to no one, and are a power unto themselves. For these reasons, members are attracted to militias as a safeguard against such actions.

The militias can also cite further violation of the Constitution and Bill of Rights. There is the growing assumption of power by the United Nations over many aspects of U.S. foreign policy. For example, the presi-

GATT and NAFTA treaties in spite of public opposition. Some militias view these agreements as evidence of an impending New World Order. Add in persistent sightings of "black helicopters" and rumors of nationwide detention centers and you have a certain explainable paranoia among Constitution-loving Americans. These fears manifested themselves in a militia attack on a U.N. "garrison" in Wickenburg, Arizona, (see "U.N. Troops 'Invade' Arizona," *SOF* Feb. 1995) and in no small degree in the 1994 elections.

Citizens militias should not be confused with state defense forces or state militias. These types of "militias" have specified duties to perform in the event the state's National Guard is federalized. Citizens militias have no state-defined duty, though 47 states have some type of militia law as re-



The Texas Light Infantry practices Ranger tactics. Other training includes live fire exercises and MOUT drills. All TLI units train a minimum of once a month. Photo: courtesy TLI

the Second Amendment but relies on common law — the right of every individual citizen to come together with other citizens for the common defense.

USSF/NM has a standard chain of command, is not affiliated with any state citizens militia, and does not promote carrying or use of weapons in any mission. It has members nationwide and overseas. In addition to active duty military personnel, there are also a large number of retired former military officers and NCOs on the membership rolls.

I spoke with the local commander in Houston, Brigadier General Carl D. Haggard, Fort Bend County, Texas. Haggard is a former assistant district attorney and chief prosecutor for the Harris County district attorney's office in Houston, Texas. He was a keynote speaker at the 2 July 1994 War Memorial and Tennessee Bill of Rights rally in Nashville, Tennessee; and lead speaker at the Committee of 1776 National Gun Rally, 14 August 1994, held at the Lincoln Memorial, Washington, D.C. Haggard said, "The USSF/NM is a charitable organization chartered in Florida. We provide rescue, first aid, evacuation services and coordinate with local law enforcement. We are patriots with a love of God, family and country."

My home state of Texas serves as a good microcosm of the citizens militia movement, with several active in the state. As do all militias in Texas, the Texas Constitutional Militia (TCM) operates under the provisions of the 1876 Texas Constitution. That document gave the Texas Legislature the authority to organize and discipline any and all types of militias. In 1969 this power was taken back by the people of Texas when Article 16, Section 46, was repealed. The people of Texas now hold the power to organize, equip and train their own militias without any interference from the state legis-

lature. In addition, the TCM also operates under those common law rights protected by the First and Second Amendments to the U.S. Constitution, and by Article 1, Sections 23 and 27 of the Texas Constitution.

lies, they gathered in front of the "Shrine of Texas" to pledge their allegiance to the Constitution. Local newspapers and network television affiliates had reporters present and coverage of the event was on the evening news.

Another Texas militia group, the 1st Battalion, Texas Light Infantry (TLI), was formed in the Dallas, Texas, area in 1984 by Bob Holloway, a Vietnam veteran. The 2nd Battalion, TLI was activated in the Austin area in 1986. The 3rd Battalion, TLI is headquartered at Bryan College Station with Major Gert Ording (ex-Navy medic), CO, and Captain Larry Wiese (Marine Vietnam vet), XO. The 4th Battalion, TLI, was formed in El Paso by an ex-Ranger.

Training activities for the various TLI units include field operations, map and compass instruction, night tactical problems and live-fire exercises. An urban assault training house is also used during MOUT (Military Operations in Urban Terrain) tests. All units train a minimum of once a month and try to increase membership by scheduling additional recruitment meetings whenever possible.

Federal agents — FBI and ATF — have been active in monitoring some Texas units. At one point, the Austin FBI office sent agents up and down residential roads asking neighbors a series of questions about militia members living in the area: who are they, where do they live, do they have weapons, and where are they employed? The agents wanted to compile a mailing list of the members and stated to one member that they wanted "to work out a plan where each member will come in 'voluntarily and chat'" with the agents.

Later, agents from the same office told one group they would "like to come out and watch the training." When the battalion CO asked the agents why, the "Fibbies" said that they'd been Marines. When told to bring a "ruck," the FBI "former Ma-

Michigan Militia Wolverines

The Michigan Militia, members of which are featured on this month's cover, is one of the largest and best organized militias in the United States. By late 1994, it claimed more than 12,000 "Wolverines," male and female.

The Michigan Militia consists of four divisions, each corresponding to a region of the state. The 1st, or "Superior" Division operates in the deep forests of Michigan's Upper Peninsula, while 4th Division covers the state's southernmost counties. Each county has a corresponding brigade. In the Michigan Militia, the brigade is the primary operational unit — consisting of one or more rifle platoons. Engineer and specialized units are attached to divisional commands. The member-elected brigade commanders are county residents. Brigades regularly engage in local field exercises during wet and cold weather. Those training at Fort George William, a private facility, participate in live fire exercises.

Militia custom provides for an olive drab U.S. flag to be shoulder-worn with the heading rearward. General Olson, state commander, has said this symbolizes that the "wind of God" is behind the militia. Other shoulder patches denoting "Civilian Militia," as well as brigade numbers or logos are worn. Divisional insignia and name tapes appear on the chest.

Although militias have existed previously, the Michigan Militia was formed in April 1994. Membership skyrocketed after the now-defeated, leftist Congress assailed the U.S. Constitution with the so-called Crime bill.

Members are largely libertarians, populists and republicans. They include most faiths and many are veterans. The militia leadership is populist, Christian and stridently anti-U.N. Despite the law abiding non-violence of its demonstrations, the Michigan Militia is preparing to face the ruthless violence of the ATF, HRT and their comrade organizations.

— James McQuaid



On 12 November 1994, the TCM held what was to be the first meeting of the Texas militia at the Alamo in San Antonio, Texas. A crowd of nearly 500 attended, including members of various militias from around the state. Together with their fami-

Join A Militia — Break Th

Legal research on the subject of militias raises the question of their authority to organize. Article 1, Section 8 of the Constitution of the United States provides that: "The Congress shall have the power ... To provide for calling forth the militia to execute the laws of the Union, suppress insurrections and repel invasions ... To provide for organizing, arming, and disciplining, the militia, and for governing such part of them as may be employed in the service of the United States, reserving to the states respectively, the appointment of officers, and the authority of training the militia according to the discipline prescribed by Congress."

The Second Amendment reads: "A well regulated militia being necessary [for] a free State, the right of the people to keep and bear arms shall not be infringed."

The Constitution, therefore, demonstrates that militias are a creature of the state, subject to being called forth by the U.S. government "to execute the laws of the Union ..." This is bolstered by the wording of the Second Amendment which holds, "A well regulated militia being necessary [for] a free State ..." and by Article 1, Section 8, Subsection (16), which reserves to the states "the appointment of officers and the authority of training the militia ..."

Title 10, U.S. Code, Section 311 further stipulates that the militia consists of *all* able-bodied males aged 17 to 45, both citizens and those who have declared their intent to become citizens, and of female citizens who are officers of the National Guard. It also specifies that the militia consists of two classes: the organized militia and the unorganized or reserve militia. Many states have similar statutes. Those citizens who apply, or are called up for service and are accepted by a state militia, are part of an organized militia. All others eligible under the law are members of the unorganized

militia, and are subject to call up by the state.

Thus, while most citizens are members of the militia, and therefore have the right to keep and bear arms to respond to a call to assemble by lawful authority, the appointment of officers, and the training of militia members are the responsibility of the state. These militias that purport to support the Constitution, yet have appointed their own officers and conduct their own training without authority from the state, are therefore in apparent violation of Article 1, Section 8, Subsection 16 of the U.S. Constitution.

The Michigan Constitution provides in Article III, Section 4, that "The militia shall be organized, equipped and disciplined as provided by law." This "rump" organization has not been "organized, equipped and disciplined as provided by law."

Instead, private citizens, well-meaning though they may be, have organized, equipped and presumably disciplined themselves without any legal authority whatsoever.

Interesting enough, the state of Michigan, and a number of other states, already have organized militias other than the National Guard. In Michigan, this militia is known as the Michigan Emergency Volunteers.

Other states call their organizations State Guards, State Military Reserves, State Militias or State Defense Forces. One wonders why this Michigan group doesn't simply join the authorized and organized Militia of Michigan.

Further evidence that states retain the power to govern and regulate militias can be found in *American Jurisprudence*: "... the state governments have the power to regulate or prohibit associations and meetings of the people ... and they also have the power to control and regulate the organization, drilling, and parading of military bodies and associations, except when such bodies or associations are authorized by the militia laws of the United States. The exercise of this power by the states is necessary to the

"State governments have the power to regulate or prohibit associations and meetings of the people."

rines" asked, "What's that?"

Shortly after the FBI failures, an ATF agent visited one of the field camps. When asked to produce some form of identification he refused and left. Additionally, the Austin chapter of the Anti-Defamation League has launched an "investigation" of the TLI for reasons best known to themselves.

Citizen militias enjoy strong support in the West where individuality and personal freedoms are still highly valued. For these reasons and others, the Militia of Montana (MOM) was founded 20 years ago and is a family enterprise headed by John and Dave Trochmann and Dave's son Randy.

MOM is extremely well organized.

They publish a well-prepared information booklet that contains the history of the militia movement beginning in 54 B.C. with Caesar's invasion of Britain, research of U.S. militias, and a section on "Interpreting the Meaning and Purpose of the Second Amendment," along with quotes from the *Federalist Papers*

e Law?

public peace, safety, and good order. To deny the power would be to deny the right of the state to disperse assemblages organized for sedition and treason, and the right to suppress armed mobs bent on riot and looting.

"Prohibiting any body of men, other than the regular organized militia and the regular troops of the United States, to associate themselves together as a military company or organization, or to drill or parade with arms without a proper license, is not violative of the federal Constitution."

In light of this guidance, states have enacted legislation regarding militia-type training. The California Penal Code Section 11460 states:

"(a) Any two or more persons who assemble as a paramilitary organization for the purpose of practicing with weapons shall be punished by imprisonment in the county jail for not more than one year or by a fine of not more than one thousand dollars (\$1,000), or by both.

"As used in this subdivision, 'paramilitary organization' means an organization which is not an agency of the United States government or of the State of California, or which is not a private school meeting the requirements set forth in Section 12154 of the Education Code ...

"(b)(1) Any person who teaches or demonstrates to any other person the use, application, or making of any firearms, explosive, or destructive device ... or any person who assembles with one or more persons for the purpose of training with ... the use of any firearm ... with the intent to cause or further a civil disorder, shall be punished ..."

The Second Amendment should not be confused with the legality of citizens militias. The NRA, while supporting and defending the amendment, does not believe that the right to keep and bear arms is dependent upon membership in a militia, and has drafted this response:

"It is the NRA's view, based on law (Article 1, Section



The TLI operates under provision of the Texas Constitution. In 1969 Article 16, Section 46 was repealed, returning to the people of Texas the power to organize, equip and train their own militias without any interference from the state legislature. Photo: courtesy TLI

8 of the U.S. Constitution; Title 10, U.S. Code, Section 311(a), court precedents, and legal and historical interpretation, that all able-bodied persons, explicitly those between the ages of 17 and 45, are members of the federal unorganized militia, except members of the organized state guards ... the National Guards of the various states (which also serve as a part of the National Guard of the United States, a military reserve subject to nationalization by the president of the United States), and certain government officials. An "organized citizen militia" must be created under the Constitution itself and/or the laws of a state.

"Title 10, U.S.C., clearly affirms the existence of the citizen militia; it is little changed since the original Militia Act of 1792 (except for the addition in this century of recognition of the third type of militia, the federally supported National Guard, in addition to the enrolled and unenrolled militia).

"Further, the individual right to own firearms is guaranteed by the Constitution, but the right to own firearms is not at all dependent upon the militia clause. The militia clause of the Second Amendment merely adds to the reason for the right, which is a common law right rooted in the right of protection of self, family and community.

"The Second Amendment guarantees an individual's right to arms; participation in a citizen militia organization does not make that right more valid nor any stronger."

—Wayne Anthony Ross

regarding the right to bear arms. A section of the pamphlet covers the rules and regulations governing MOM, and instructions on the formation of similar militias in other states. MOM does a thriving business at various gun shows, networking, producing and selling videotapes that cover current Second Amendment

cases and violations of citizens' constitutional rights by agents of the federal government.

When asked about training schedules and venues, John Trochmann smiled and replied, "If there's any training carried out it will be as private as family devotion." MOM maintains close ties with the U.S. Congress

through their liaison officer, Bob Fletcher, formerly a congressional investigator.

Some militias have grown out of a specific need or fear. On 2 August 1994, a group of ranchers and other citizens met at a Catron County cham-

Continued on page 81

Somalia Firefights

The **FAST** And The Dead

Elite Marines First In, Last Out Of The Heart Of Darkness

by Dale B. Cooper
Photos courtesy author

U.S. interest and direct involvement in Somalia went downhill after 18 U.S. Army personnel including Green Berets, Rangers and Blackhawk crewmen were gunned down during fierce fighting in the streets and alleys of Mogadishu on 3-4 October 1993. Bowing to congressional pressure, President Clinton ordered all U.S. forces to leave Somalia no later than 31 March 1994. Their departure was in stark contrast to prime-time coverage the first Marines received in 1992 when they came ashore in Somalia to “Restore Hope” to that East African nation.

By the time the last Marines left, no one cared about restoring hope. But the United States did maintain a presence in Somalia — the U.S. Liaison Office (USLO). The

FAST convoy ready to move out into “Indian Country.” Lead vehicle displays business end of Mk19 automatic grenade launcher — one of the best anti-Somali weapons in Marine arsenal.

task of protecting the diplomats attached to the USLO fell to the elite Marines of FAST, the Fleet Antiterrorism Security Team.

FAST is just what its acronym indicates: a rapidly deployable, internal security unit which is lightly armed with M16A2 rifles, M203 grenade launchers, MP5 submachine guns, M16A2 M4 carbines, M249 SAWs, 12-gauge shotguns and M9 pistols. With convoy security added to its mission in Somalia, FAST added heavier ordnance — like 40mm Mark 19 Mod 3 automatic gre-



nade launchers, M2 HB .50 caliber Browning machine guns, M60 GPMGs, AT4 anti-tank weapons, LAWs, claymores, bangalore torpedoes, cases and cases of hand grenades and enough C4 to level Mogadishu.

The heavy stuff, Mk19s and M2s mounted on HMMWVs (Hummers), gave FAST an awesome mobile capability. Each armored HMMWV carried a five-man crew. In addition to the driver, who carried an MP5 submachine gun, the vehicle commander and left and right rear-gunners carried M16A2 M4 carbines with a couple of AT4s tucked between their legs. The top gunner was behind either a Mk19 grenade launcher or M2 machine gun. He also carried a 12-gauge shotgun for up-

close, in-your-face work. Each Marine carried a sidearm and max load of rifle ammo on his LBE. Thirty additional preloaded magazines and dozens of hand grenades were carried in ammo cans inside the vehicle. Since the Somalis didn't have protective masks, each HMMWV also carried a couple of cases of CS grenades.

The typical FAST convoy consisted of four HMMWVs mounting two Mk19s, one in the lead position, and another at the rear. A turret-mounted M60 machine gun was in another HMMWV behind the lead, and an M2 was just ahead of tail-end-charlie. The rear HMMWV's clamshell (rear-sloping hood) was removed and rigged with a chair so a Marine with an M16A2 and M203 could cover "six," as the convoy sped down the streets of Mogadishu at 45 mph.

FAST Firefight

Staff Sergeant Milton Hardin missed the Gulf War, but saw his share of combat in Somalia. Hardin was escorting U.S. diplomats to a meeting with Somali warlord Mohamed Aidid's people when he unknowingly led his FAST convoy of three Hummers and two Chevy Suburban limousines into an ambush at the K-4 Circle, a major intersection in Mogadishu. The action began when two Somali gunmen took up firing positions behind a tree on the left side of the road. Without warning, someone opened fire from an upper floor window of a building at the rear of the convoy.

"The rear man in the tail vehicle, Lance Corporal C.R. Hamilton, dropped the individual as my .50-cal gunner, Lance Corporal M.D. Snelson, swung around and got rid of the two threats on the left side of us," Hardin said as he recounted in detail the lightning-swift attack and his instinctive moves to counter it. "We began to take incoming fire from the right side of the convoy as we entered the circle."

As the fight developed, Somalia National Alliance (SNA) militia came out of the woodwork and attempted to block the convoy's escape route.

"It was kind of a chain-reaction type thing," Hardin said, "because once the shooting started, every Somali with a weapon decided he'd get him some Americans."

Two Isuzu gun trucks on the Via Moscow and Via Lenin avenues leading off the circle opened up on the convoy. But the M2 chopped them up like hamburger. As a group of gunmen ran into the circle from

the right side firing their AKMs wildly from the hip, Lance Cpl. D. Krahlung on the Mk19 cut them down. One trigger pull sent a spread of 22 rounds of high-explosive grenades into their midst.

All of this violence exploded as the circle was full of people. It was the month of Ramadan, a holy time in the



Islamic world and Saudi peacekeepers were handing out dates to men, women and children. There were hundreds of them in the circle when the shooting broke out. Hardin hung out the window of the lead Hummer and fired three shots in the air in an attempt to scatter the crowd so he could get his convoy out of the killing zone.

At about that time, there was a big explosion at the circle. To this day no one knows what blew up. Maybe it was an RPG fired from a rooftop that missed its mark. Afterward, at a debriefing, the Joint Task Force (JTF) confirmed that RPGs had been spotted on rooftops in the vicinity.

Twenty-three Marines and a Navy hospital corpsman traveling with Hardin conducted a "break contact battle drill" by pushing through the kill zone. For more than 300 meters, the convoy fought their way out at a controlled and steady rate. Once out of danger, but still laying down suppressive fire to the rear, the convoy picked up speed and reentered



Although his primary weapon is Mk19 grenade launcher, Cpl. Isaacs stands ready with 12-gauge shotgun. FAST HMMWVs were heavily armed and heavily armored for good reason.

friendly lines at the U.S./U.N.-controlled Mogadishu airport.

There were three versions of the shooting incident at the K-4 Circle. Steve McIlvanine, deputy chief of USLO, said, "Snipers provoked the Marines. I wouldn't use the word ambush ... but it certainly was an attack." Major K.G. Haider, leader of a nearby unit of blue-helmeted Bangladesh U.N. troops said, "The Marines fired indiscriminately toward



FAST convoy moving through the mean streets of Mogadishu. Traffic, pedestrians and bad guys reinforced fighter pilot mentality — speed is life.

the crowd." And Mumi Greek, a Somali, told the *Los Angeles Times*, "Before they [Marines] got to the crowd they opened fire ... No shots were fired at the U.S. troops." But journalists in the K-4 hotel where I stayed said they heard what sounded like one or two single shots before the Marines returned fire.

Unlike a normal infantry unit that would have hosed down the K-4 Circle as it tried to break free of the strangle hold, Hardin's Marines used extreme discipline when engaging targets. Only 138 rounds were fired that day — not much considering the amount of incoming. But Marine counterfire was extremely accurate. Hardin believes his convoy came under fire from at least 11 Somali gunmen, "but they were eliminated." Intel reports at least nine Somalis were killed and another 30 or 40 wounded. Somalis interviewed later by the JTF said it was the most awesome display of disciplined fire they had ever seen.

Hardin's vehicle was not hit. However, an armored Hummer in his convoy was hit three times by small-arms fire after it pulled up along the left side of a Suburban containing two U.S. VIPs to protect them from the most dangerous side of the kill zone. None of the rounds penetrated the armor plating. "Thank God for 7.62x39mm [AK round], 'cause it doesn't have the penetration capability our 5.56 has," Hardin said, and explained his rear gunners were able

to make Swiss cheese out of Somali vehicles with their M16A2 M4 carbines loaded with steel-penetrating rounds. The standard-issue NATO ammunition will penetrate a quarter-inch of armor at 100 yards. AK rounds won't.

Bad Attitude Or Dead Meat

"We survived certain death because we didn't get rattled," Hardin said, "even though we were outnumbered and outgunned." In fact, FAST Company did not suffer a single casualty or any casualties among the diplomats they protected during their



U.S. Marine scout sniper at the "Alamo." Marines displayed impressive fire discipline. During single target engagements virtually all rounds hit home, just like a rifle range.

entire 18-month deployment in Somalia — no small accomplishment considering the hostile company they kept.

“I think being very aggressive is the reason,” said Captain Dutch Bertholf, commander of 2nd Platoon — the last Marines to leave Mogadishu. Like other platoon leaders, Bertholf was determined to bring his men home unscathed. “They [Somalis] knew we meant business,” Bertholf said, “and whenever they saw the ‘Big Gun,’ as they called the Mk19, they knew that we were very good with it, and could kill large numbers of them with it if they gave us reason to fire.”

Before 2nd Platoon arrived in Somalia, a Mk19 gunner shot a Somali three times in the chest. The rounds, which have to travel around 80 feet to arm, didn’t explode. The man was



FAST HMMWV crew armed with MP5, M16A2 M4 carbine, M16A2s and shotguns provided unmatched convoy protection: No Marines or protectees killed or injured — the Somalis cannot make the same claim.

too close, but the result was the same — three gaping holes were blown in his body.

Somalis respect force and when they realize force will be used against them, they tend to leave you alone. That’s why the Egyptian and Pakistani peacekeepers had problems. They were too passive and became easy prey for Somali gunmen.

FAST Company learned this lesson soon after 6th Platoon was relieved by 5th Platoon. Two of Capt. Scott Campbell’s vehicles were ambushed by SNA militia along the infamous 21 October Road when Somali gunners opened fire with AKMs on two Toyota Landcruisers,

successfully riddling the second vehicle and blowing out its front tires.

The driver, Cpl. Christopher E. Davis, didn’t hesitate. He put the pedal to the metal and sped through the kill zone on the rims at 80 miles per hour. “Had he frozen, he’d have been dead meat, and so would his passengers ... a couple of State Department officials,” said Maj. Paulovich, who recalled a similar incident involving U.N. peacekeepers in which the driver hit the brakes, causing the second vehicle to come to a screeching halt in the kill zone. The Somalis pounced on them like a lion pounces on a wounded animal; killing four Malaysians and wounding a couple of New Zealanders.

The next day, another two-vehicle FAST convoy was ambushed in the crowded Medina marketplace along Jalle Siaad Road.

This time, the RPG and small-arms fire missed the vehicles completely as they sped to safety.

Paulovich thinks the Somalis exploited the changing of the guard to test his men’s mettle. “The Somalis picked up on that,” Paulovich said, “and they realized these guys [5th Platoon] were the new guys in town, and took pot shots at them.”

The only safe haven in Somalia was the international airport, where a division of Egyptian soldiers was stationed. “But once you drove into the city, it was like going into the heart of darkness,” Bertholf said. “It was just them and us, and we knew there was no one to come to get us if we

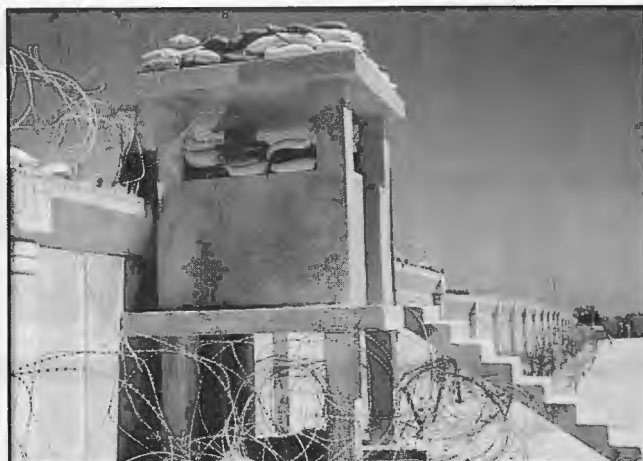

One of several Marine posts at U.N. compound. Lessons learned in Beirut dictated stronger fortifications. So strong that when pinned against the outside wall, 10th Mountain Division was unable to blow its way in.

got into trouble.” But the Marines didn’t mind being left all alone in Mogadishu. If anything, it tightened the bonds of friendship in each of the FAST platoons.

After U.S. forces pulled out at the end of March 1993, it became apparent to Bertholf the U.N. QRF (Quick Reaction Force) was “not quick, not able to react and totally unforceful. Our only hope was to form our own ‘quick reaction force,’ which we did.”

Make Every Round Count, Count Every Round

At times, Sgt. Mike Tracey, 2nd squad leader in 2nd Platoon felt like a duck in a shooting gallery as he drove down 21 October Road. Tracey’s squad of four heavily armed HMMWVs was escorting Ambassador Daniel H. Simpson, the U.S. Special Envoy to Somalia, to a meeting in Mogadishu when the convoy came under fire a few weeks before the last Marines pulled out of Somalia.

“I didn’t know where the fire was coming from the day a 12.7mm opened up on my vehicle. The shockwaves sounded like somebody rapping their knuckles on the side of the vehicle,” Tracey said. Startled, he turned around and looked over at Lance Cpl. Ricky Sanders and asked if it was him shooting or if someone was throwing rocks at their HMMWV.

That’s when Lance Cpl. Andy Isaacs, the Mk19 gunner yelled, “There’s somebody shooting at us from the buildings.” Isaacs heard rounds over his head, but was unable to locate the source of the hostile

Continued on page 74

Chalk Up One For The Good Guys

KATONA GETS HIS GUNS

by James L. Pate

The call from a friend at the NRA lit a short fuse. With national elections a month away, he told me that Jack Brooks, chairman of the House Judiciary Committee, planned a press conference to announce spring-time hearings on the persistently abusive conduct of the BATF. The committee staff asked the NRA to suggest an example or two of the outrageous conduct commonly condoned by ATF, people the chairman could trot out for the press. Knowing I regularly chronicle such cases for *Soldier Of Fortune*, the NRA called me for leads.

After the meaningless dog-and-pony show put on by the same committee in the smoldering aftermath of the Waco massacre, I was skeptical. Jack Brooks, the cantankerous Texas Democrat heading the committee, later sold out the Second Amendment by voting to ban many types of semi-automatic, military-style rifles. Why should Brooks be so eager now to tackle the tawdry tendencies of the ATF?

"Because he's in big trouble with the gun owners in his district and he wants to get back in our good graces," my friend told me, the glee in his voice undisguised. Ah, yes. A bumper sticker came to mind: "I'm the NRA and I vote."

One case that would serve was that of Louis Katona III, the Ohio businessman and part-time police officer who was targeted by the ATF just because he was an avid machine gun collector. During the subsequent raid, Katona's wife, Kimberly, miscarried what would have been their second child, after being slammed into a wall by ATF Agent Steven St. Pierre. The agent was a newly named group supervisor in the ATF's Cleveland office.

The facts of the case were this: The 8 May 1992 raid resulted in the seizure of 32 legal automatic and other Title II weapons with an appraised value of \$107,000.

After waiting almost a year with no word from ATF, except on their intent to keep his property, the Katonas sued St. Pierre and ATF agents Lance Lee Kimmell and Stephen C. Wells. Also named as defendants were the city of Bucyrus, Ohio, where the Katona family has lived for generations, and the local police chief, Joe Beran, a beer-bellied biker bully who later was ATF's chief witness.

Only after being sued did Kimmell, the case agent, urge Assistant U.S. Attorney Robert Bulford to seek Louie Katona's indictment (see "Miscarriage of Justice," *SOF* April '94). On 25 April 1994, U.S. District Judge George White dismissed charges against Katona because "There is no evidence a crime has been committed." (See "BAT-'F' Troop Rides Again," *SOF* August '94.) Beran has put in for retirement. Bulford was exiled by U.S. Attorney Emily M. Sweeney's office in Cleveland to scut work in Akron.

"It's kind of short notice, but you're going to be in Washington anyway, so why don't I take a long shot and try to get you on G. Gordon Liddy's radio show?" I asked Katona. "Super," he said. I phoned up Liddy's producer, John Popp. After some quick juggling of the production schedule, Popp called back. "You're on," he said.

We managed to delay the press conference for 24 more hours and Katona, accompanied by his mom, Sharon, arrived in Washington 5 October. I met them the next day at their hotel with one of their lawyers, Robert E. Sanders, now a regular *SOF* columnist. We all piled into two cabs and, as we headed for Capitol Hill, Louie updated me on his case.

"I finally got my guns back," he said, smiling at the thought. Not only did U.S. District Judge David Dowd Jr. order the ATF to return Katona's property, he specified the date (19 September 1994) and the time (1300 hours) that it would be delivered to the Katona residence. He ordered that no agents involved in the raid be there. Dowd dismissed "with prejudice" the ATF's claim on Katona's guns, meaning the bureau could not refile.



Former U.S. Rep. Jack Brooks, D-Tex., then-chairman of the House Judiciary Committee, talks to the press about ATF outrages as the Katona family waits to talk with reporters. From left, Louie's mom, Sharon Katona; his wife, Kimberly; baby Cassidy; his son, Louis Katona IV and the proud father and patriot gun owner, Louis Katona III. Despite Brooks' blustering about grabbing ATF by the scruff of the neck, voters in his district remembered that Brooks sold them out on the assault rifle ban. The cantankerous Texan got dumped in November like a greenhorn cowboy at his first rodeo. Photo: James L. Pate



From left, the author, G. Gordon Liddy and Louis Katona III strike a pose after appearing on Liddy's nationally syndicated radio talk show. While the mainstream media, notably Cleveland's *Plain Dealer*, ignored the Katona tragedy, *Soldier Of Fortune* broke the story and has kept it alive, with the help of patriots like Liddy. Photo: Sharon Katona

The Justice Department assigned staff attorneys out of Washington to defend the ATF agents against Katona's suit. Kimberly Katona is not a Tammy Faye Bakker-style grandstander with leaky water works. To the contrary, she avoids the spotlight. But when government attorneys taking her deposition for the civil suit badgered her repeatedly for the most minute details of the incident resulting in her miscarriage, she couldn't help it. As they made her explain, nanosecond by nanosecond, what she was thinking and feeling as she was put against the wall by a supposed public servant — when her vital link to her baby-to-be snapped in a brutal instant — she began to cry.

It must have struck some primordial chord with a female attorney sitting at the government's table, who had to pause to wipe her own eyes, Louie recounted. The man questioning Kimberly Katona continued, pressing her to dredge up more pain. Another pause, this one more protracted, came when the court recorder, a woman whose job it was to record with complete accuracy what was said, got teary-eyed, delaying the proceedings while she composed herself. It finally dawned on the federal attorney that his line of questioning might not incline a listening jury toward the best interests of the government's defense. The attorney suddenly changed the subject.

Defying all logic, Joe Beran still holds his job as police chief. The city finds itself in the untenable position of admitting, at the risk of potential civil damages, that Chief Beran willingly lied for the ATF in its effort to convict Katona, and firing Beran. Or they could defend a man whose main reputation in the community is that of a besotted philanderer. They have chosen the latter course, and speculation is that Beran must hold some high markers on the city fathers — and maybe some of the mothers,

too. But Beran is cashing in his chips and getting out of the game, making plans to head on down the highway on his Harley. No doubt well-wishers will buy him gifts — perhaps a year's subscription to *SOF* — and lovers of law and order will line the bucolic Bucyrus sidewalks to wave farewell to this dashing, hawg-straddling bon vivant.

Unfortunately, two honest officers on the Bucyrus department, patrolmen Jerry Agee and Ralph Grubel, did not keep their jobs. Both were fired by Beran, ostensibly for providing documents to Katona's attorneys. Their real offense, however, appears to be their unwillingness to lie.

"If these two officers are guilty of anything," said Ronald M. Studer, president of the Bucyrus chapter of the Fraternal Order of Police, "it is supplying factual evidence to the court in pursuit of the truth. Had Mr. Katona been guilty, their evidence would have buried him. As it turned out, that evidence played a role in exonerating him. Had these two officers not taken the action they did, an innocent man could be sitting in jail."

In a personal letter to U.S. Attorney Sweeney, Katona's co-counsel, James H. Jeffries III of Greensboro, N.C., complained about the actions against Grubel and Agee, urging her "to take appropriate action ..." Jeffries noted that the two policemen "are witnesses in two federal cases and a related federal integrity investigation ..."

and that both are subpoenaed witnesses in Katona's lawsuit against the ATF agent, Chief Beran and the town of Bucyrus.

"Please note that Patrolman Agee is also a witness against BATF Special Agent Lance Lee Kimmell in a perjury/misconduct investigation by the Office of Internal Affairs of BATF, arising out of [Katona's] criminal prosecution. The BATF inspector conducting the integrity investigation of Special Agent Kimmell made sure that Chief Beran learned of Patrolman Agee's status as a witness against Special Agent Kimmell. One of Beran's underlings was even permitted to sit in on the witness interview."

Jeffries' letter also advised the U.S. attorney that Beran was the main federal witness and, as such, "During the trial of the criminal case, a subpoenaed defense witness reported a death threat by Chief Beran made in front of numerous witnesses, a matter which was disclosed to Judge White and reported to the FBI ... It seems clear

from [Agee and Gruber's] suspensions [and ultimate dismissals] that Beran, possibly aided and abetted by Kimmell, is still engaged in a campaign of harassment and intimidation of federal witnesses ... This would seem to constitute a criminal contempt of court ... as well as criminal obstruction and tampering ..."

At any rate, the House Judiciary Committee press conference was a mixed success. The public exposure of Katona's case served a good purpose, even if Brooks' personal insincerity and political expedience were obvi-



Louis Katona III, squatting, inspects one of the 32 NFA weapons seized by the ATF from his home and returned under federal court order, while Katona's friend, Larry Palmer, a former Navy SEAL, removes more guns from canvas bag. A federal judge ordered the feds to wear no weapons, and he specified the day and precise time that they were to show up. ATF agents Kimmell, Wells and St. Pierre were ordered to stay away. ATF agent Larry Brouk of Cleveland, arms akimbo, rear, doesn't look too happy about his assignment. Photo: courtesy Louis Katona III

Continued on page 78

National Police Force Training Manual?

by SOF Staff

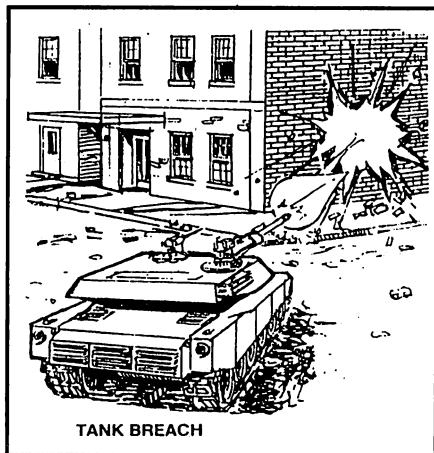

FM contends, "Ideally, when entering [buildings] at lower levels, demolitions, artillery, tank fire, anti-armor weapons fire, or similar means are used to create a new entrance to avoid booby traps." Could this explain Waco tragedy?

tional areas such as Haiti, Panama and Somalia were noteworthy for the extensive Military Operations in Urban Terrain (MOUT). And leaders purposefully avoided such costly actions in the Gulf War.

Other military conflicts in Bosnia and Chechnya demonstrate a changing

ment and effects of weapons systems, it leaves little uncovered.

Space is also devoted to the ramifications of a uniformed enemy among a civilian population. The lenient Rules Of Engagement for the battle of Aachen during World War II are contrasted with the restrictive ROE issued during Operation Just Cause. The impact such rules have on military operating systems is a vital consideration during planning and training.

When summarizing offensive MOUT operations, the events of October 1993 in Mogadishu spring to mind. "Good cover and concealment in a built-up area gives the defender an advantage. Attackers must fight from the outside into a well-defended position ... more troops are normally needed than in other combat situations ... [and] normally results in a greater number of casualties."

FM 90-10-1 contains specific guidelines for a reserve force — a force that was tragically missing in Somalia: "The reserve should be mo-

Continued on page 82

Would the government write a manual on urban warfare and then not let anyone read it? That's what seemingly has happened with FM 90-10-1, *An Infantryman's Guide to Combat in Built-Up Areas*.

We contacted several Army sources to obtain this manual through normal channels but were unsuccessful. Their excuses varied: The manual was printed as a limited edition; it was not yet available for general use; economic cutbacks forced limited distribution.

Are military leaders squeamish over their strategies to capture metropolitan areas such as Panama City or Port-au-Prince? Is it a secret manual describing the training of a national police force, or have defense cuts deprived our armed forces of timely information?

This is a particularly befitting topic as urban populations and areas have been steadily growing. Increasingly the centers of political and industrial power, cities are often the hub of crime and conflict. America's traditional martial maneuver areas, Europe and Asia, have experienced unprecedented growth. Non-tradi-

tion battlefield. The distinction between armed forces and police forces is disappearing. Police departments are militarizing their weapons and tactics, while armies are increasingly taking on traditional law enforcement roles. Such trends guarantee MOUT will be the future battlefield.

This is one of the more well-written and thought-out Army FMs to come along. With chapters describing special considerations for urban operations, analysis of built-up areas, offensive and defensive operations, necessary combat skills, and employ-

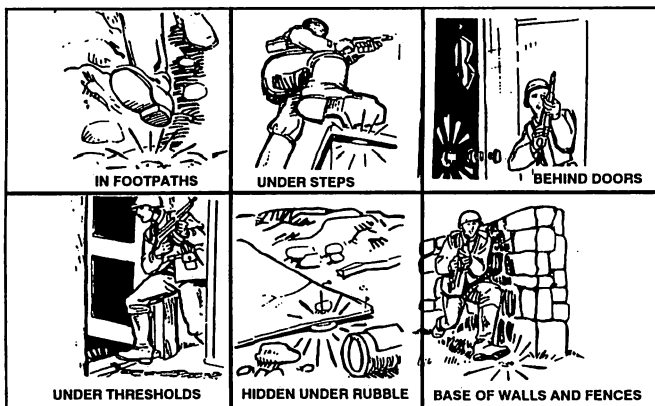

Figure C-5. Emplacing the M14 antipersonnel mine.

Bad guys and booby traps give MOUT a bad reputation. FM covers where to look and where to put anti-personnel mines, and the labor-intensive tasks necessary to reduce casualties in such an environment.

SPIKING A LOOSE CANNON

FBI Uses KGB Tactics To Jail SF Operator

by Jim Morris

Photos courtesy Keith Idema

Keith Idema has served his country as a Special Forces NCO, an intelligence operative and successful businessman. While training the Lithuanian special forces (as a civilian) he uncovered an international nuclear smuggling ring. When he brought this and other intel to the FBI's attention, the bureau took offense and set out to destroy him. This is the final part of the Keith Idema saga started last issue.

Idema was told he could cooperate with the FBI the easy way or the hard way. He found out what "the hard way" meant. With little prompting, his business "partners" all pointed the finger at Keith. Andrea Graves, a partner in Charlene Hambrick's International Special Operations Convention company; Don Valenzuela, her show manager; Craig Toth and Ray Winslow who worked with Hambrick and her

Keith Idema in Desert Assault Vehicle at his 1991 Special Operations Expo at Fort Bragg, North Carolina. Even armed with a Browning M2 HMG, AT4 anti-tank missiles, machine guns and assault rifles, he was out-gunned when the long arm of injustice threw its punch.





Idema lived and breathed special operations, from his time in Special Forces to his civilian ventures as a specops trainer and convention organizer.

husband, were the four main witnesses against Keith. All were highly questionable. All were working with or for Hambrick. All were guilty of wire fraud, according to Keith, though only one has ever been charged with a crime: Craig Toth was charged with one count of aiding and abetting wire fraud, but he's never been sentenced.

That the government was willing to give up four to get one confirms Keith's assertion that he was the target. Keith's apparent motive was to save his faltering Idema Combat Systems. But his father insists that the Special Operations Expo alone was profitable enough to carry ICS.

The government needed another witness. Agent John Strong interrogated Keith's girlfriend, Dawn Glosson, at some length. According to her, Strong insisted she implicate Keith. She refused, replying there was no truth to the allegations against him.

Hambrick's cronies had accused Keith of slapping Dawn around a lot. Agent Strong, acting on those allegations, offered Dawn a witness protection arrangement if she would testify against Keith — and threatened to take away her 12-year-old son and put her in prison if she would not.

I've since learned this is a fairly standard police ploy. They figure that 90% of the time if you go for the guy's old lady and threaten her with time as an accessory, she'll sell him out. Dawn, however, afforded agent Strong the opportunity to become familiar with the colloquialism, "Go shit in your hat."

Actually Dawn and Keith are about the most lovey-dovey couple I know when they aren't screaming at each other. She takes a certain amount of crap from Keith, who, as noted, rants and raves a lot. Then she rips him a new one in a manner that puts any ass-eating I've ever seen administered on four continents, by any officer or NCO of numerous armies, in a

very deep shade. Whatever their game is, it's nobody's business until one of them asks for help. Dawn and Keith aren't asking.

Witch Hunts And Kangaroo Courts

But wait, you must say to yourself, the FBI is a professional organization. They have an internal affairs office called the Office of Professional Responsibility. Keith has several old Army buddies who have become FBI agents. He worked closely with the FBI providing intel on terrorism. How was agent Strong able to mount a witch hunt like this?

Keith contacted one of his FBI friends. When that person began nosing around, he was dragged into an elevator by, according to Keith, none other than Assistant Deputy Director Ronnie R. Coulson, the agent who originally formed the FBI Hostage Rescue Unit. Keith also insists that he officiated at the Randy Weaver fiasco and was the man who screwed up Waco. He dragged Keith's pal into the aforementioned elevator and told him, "Stay out of it. This is a Bureau matter. It's personal."

So far this is all Keith's word,

which, admittedly, is not objective on this matter. Plus, Keith has a tendency to tell his stories in the most colorful manner possible. So I called his buddy at the FBI. He would not confirm that it was Coulson who told him to back off, but he would confirm that *somebody* did.

Agent Strong was free to rock 'n' roll. Yet, for all that, the first trial on wire-fraud charges ended in a hung jury. The government deposed witnesses on three continents, but really didn't have much of a case. Keith's high-powered lawyer, James Larrosa, made mincemeat out of the government attorney, Dan Boyce. In all likelihood the jurors who voted to convict only did so because Keith was painted as a woman beater. Dawn wasn't allowed to testify otherwise, on the theory that Keith had threatened her life, and therefore her testimony was tainted. Considering that she ran his business for him while he was in jail, continued to live in his house and insisted they both were innocent, this has little credibility.

From arraignment through trial, Keith was confined to his offices and shop, wearing a cuff that would set



Idema trains with AKSU-74 at ultra-secret Omon base in Lithuania. His overseas training missions uncovered backpack-nuke smuggling scams and resulted in valuable intelligence gathering, but did not endear him to the FBI.

off an alarm if he left the premises. Boyce immediately refiled for a second trial, and Keith went right back into the cuff. He is actually the only accused white-collar criminal in the Eastern District of North Carolina to ever be denied bail — because he is a violent, aggressive, ex-Green Beret who is apt to kill all his enemies and skip town. The mockery, of course, is that the cuff prevents nothing; he has



Standing in the Moscow train station in a Russian colonel's Alpha Group uniform, Idema demonstrates his go-anywhere, do-anything attitude. This same behind-the-lines spirit would wear thin in a U.S. civilian courtroom.

yet to be confined to a jail he can't break out of once he really puts his mind to it.

The circumstances of the second trial, on 7 March 1994, were far different from the first. Keith had blown all his money and most of his father's on Larrosa, upward of \$400,000. Notice that they *had* \$400,000, which seems to prove they didn't need \$200,000 allegedly netted through the wire fraud.

So, for a smaller fee they hired Mike Ross, Larrosa's partner. Ross is a nice guy, but not a courtroom powerhouse like Larrosa. Boyce, even though he had resigned from the U.S. Attorney's office, was asked back — or asked to be brought back — for this trial as a "special prosecutor." And somehow the "special" judge who drew the case was 86-year-old Franklin DuPree. In more than semi-retirement, he actually only tries one case a year. DuPree is most famous for having tried the Jeffrey MacDonald case — the Green Beret doctor convicted of killing his wife and daughters after the Army had already cleared him. The case was made famous in Joe McGuinness' book

Fatal Vision, and an entire cult has grown up around proving his innocence.

Keith heard that Judge DuPree had been quoted as saying, "Green Berets, they're all baby-killers." I wasn't able to trace this quote down, but a spectator at the trial said, "No, Judge Dupree pretty much confined his prejudice to body language in the courtroom." It didn't matter. Both Keith and Dawn were convicted in short order. Dawn was released on bail pending sentencing. Keith went to jail.

Meanwhile, Keith investigated the FBI's forensic evidence in preparation for his sentencing hearing and new motions — not the easiest thing to do when in prison, but he managed. There was a file card credit reference used in the scam that presumably had only Keith

and Dawn's fingerprints on it. Keith claimed that agent Strong handed both he and Dawn the card during the investigation and asked if they had ever seen it before. Strong insists he *never* handed them the card.

That Keith and Dawn's prints were on the card was damning at the trial. But later Keith learned that the particular fingerprint test the FBI administered is only good for picking up prints placed on objects within a year. Instead of proving that Keith and Dawn handled the card during the time of the commission of the crime, it proves instead that they handled it later, during the investigation and during the time it was in the FBI's possession.

There was also a credit reference for a dummy corporation signed by one "Patricia Tyree." At the second trial Andrea Graves, Charlene Hambrick's partner, testified that Keith tried to get her to sign this phony name but she had refused. She went on to testify that Dawn had fraudulently signed it in her presence.

During the first trial agent Strong testified that it was impossible to test a photocopy of a handwriting sample,

and for that reason the FBI had not done so. This doesn't seem very logical, and in fact it is not true. Keith hired a forensic lab run by the former chief of forensics at the U.S. Treasury Department. This lab submitted a report that absolutely clears Dawn; it's not her writing at all. It also states that there is an 80% probability that the writing is that of Andrea Graves.

So far, it appears fairly clear that the evidence on which the pair were convicted proves their innocence. But the charade continued through the sentencing process. At Dawn's hearing a court-appointed psychologist told a highly incriminating story: Keith had pistol-whipped her unconscious and locked her in a closet.

After the hearing Dawn explained what that was all about. "He put two stories together. This was before Keith and I started going together. I was gonna go out with this biker who belonged to the same club that Keith's old girlfriend ran with. He'd had trouble with 'em before. Once they shot up the office. He said he'd have to protect himself if I brought them around. He pulled his .357 out of the desk drawer and put it on the desk.

"That was one time. Another time I fainted and woke up by the closet. But Keith wasn't even there then. He never hit me, with a gun or otherwise, and one time I just fainted."

Jailhouse Rock

I've known Keith, at least over the phone and through other people, for about 10 years. On only one occasion have I known him to be afraid: He was thrown into AIDS isolation with 26 prisoners — all black. There's nothing wrong with being black, but it can be presumed that a lot of black guys in jail might blame the white man's "justice" system for putting them there, and might be expected to seek revenge on the only available white guy. Keith has taken on multiple opponents in bar fights, but never 26 of them. He was shaken, and that's no lie.

I talked to him two weeks later, after he had been moved out of AIDS isolation and into a cell block with violent criminals, murderers and rapists. He owned the place. He was writing love letters for them and helping them file legal motions, new trial motions, motions for new lawyers, motions for continuances and bond



Demonstrating hostage rescue tactics was part of Idema's successful business. But he should have been watching his back, as four of his employees were conducting illegal transactions that landed him in jail.

reductions. In all, he filed a total of 12 and they all carried. Hey, he was doing so well that he decided to represent himself at his sentencing.

In jail he acquired two nicknames, "Rambo" and "Psycho." This latter came from his habit of not taking shit from anybody. Keith wants to see the rules. He won't allow medical personnel to administer inoculations without his permission, and he won't give his permission. He writes petitions and starts unions. He is in their faces and on their cases all the time. There is no quit to this guy.

At one point he was transferred to a jail known as a "punishment facility." He was rumored, in fact, to be the only white prisoner ever sent there. They tried to put him into a cell with a stopped-up toilet and 3 inches of water and turds on the floor.

"I'm not going in there," Keith said. There were four guards with him. "You don't have enough guys to put me in there." They got four more guards. "You still don't have enough guys." They got two more and pepper spray. Keith marched proudly into the cell. Hey, nobody said he was stupid.

Up to that point Keith had been through two sentencing hearings, usually five-minute deals. By then Keith was representing himself, although the judge allowed a highly respected

local attorney, Tom McNamara, who is also a former federal prosecutor, to advise him. The judge, Timothy Boyle, has described Keith's courtroom behavior as "outrageous," and his defense as "a fantasy," but at least he's not bored.

At the first hearing he sentenced Dawn to 15 months, with time allowed to make arrangements for her son. The judge also forbade Dawn to have anything to do with Keith.

Keith's plan at the second sentencing hearing was to put agent Strong on the stand and confront him with his new forensic evidence, but the judge didn't allow that. What he did do was agree to hear his new trial motion, giving the government time to get their rebuttal together.

Boyle is an interesting judge. He's slender, looks to be in his mid-40s, in good shape and damn smart. He

seems to alternate between fascination and outrage. He really can't believe that Keith isn't making all this up. "This was supposed to be a run-of-the-mill wire fraud case. What happened?" he said at one point during the second sentencing hearing.

Well, what happened, aside from the nuke angle, is that most defendants roll over. Ninety-seven percent of all felonies are plea bargained or dismissed. Counting the time in the cuff, Keith has already been confined for 19 months on this Mickey Mouse conviction for "aiding and abetting wire fraud." The U.S. Attorney's office is pissed that Keith won't just cop a plea — he would be free now if he had just plead guilty and he and Dawn had sold each other out.

Keith has since had his third sentencing hearing. Thrown together at the last moment, unable to call witnesses, moved from jail to jail impeding his preparation, Keith got 20 years. He has also been threatened with a sanity hearing. Of course, if the government finds him crazy and he passes the years in a mental institution, his conviction is meaningless. Perhaps the FBI picked up this tactic from the KGB. Keith faces more hearings and appeals. Quitting has never entered his mind.



Whether building a business, training foreign security forces, penetrating terrorists groups or defending himself against an FBI-sponsored witch hunt, Keith Idema goes in locked-and-loaded and never quits.

Jim Morris is a retired Special Forces major and author of the best-selling memoir War Story. Morris covered seven wars for SOF in the early '80s. This summer Disney will release the film version of Morris' story, Dumbo Drop, which first appeared in SOF in March 1980. ✕



#CB-1 50-LB. Pull Crossbow Pistol
Features FIBERGLASS frame, steel bow, 5 arrows, easy cocking mechanism, micro-adjustable sights, safety, and target. All this for an unbelievable **\$16.95**

#BT-1 EXTRA PKG OF 12 STEEL TIPPED POLY ARROWS **\$3.99**



#CB-4 80-LB. Pull Crossbow Pistol
Features METAL frame, FIBERGLASS bow, 3 metal arrows, easy cocking mechanism, foot stirrup adjustable sights, safety, and target. All this for **\$34.95**

#BT-2 EXTRA PKG OF 12 ALUMINUM ARROWS **\$7.99**



#CB-2 50-LB. Pull Crossbow Pistol
Features METAL frame, steel bow, 5 arrows, easy cocking mechanism, micro-adjustable sights, safety, and target. All this for **\$19.95**



#CB-5 150 LB. Pull RIFLE Crossbow
Features METAL frame, FIBERGLASS bow, 2-15 INCH metal arrows, foot stirrup adjustable sights, safety. All this for **\$99.95**

#BT-5 EXTRA PKG OF 5-15 INCH ALUMINUM ARROWS **\$13.99**

#BH-3 PKG OF 3 RAZOR TIPPED BROAD HEADS WHICH FIT ONTO 15 IN ARROW BT-5 **\$13.99**



SOLID BRASS PAPERWEIGHT
\$10.00
NOT AVAIL. IN TX.

NEW! ISRAELI GAS MASK
\$14.95
EXTRA FILTERS **\$6.00**



CUFFS-1 DOUBLE LOCKING POLICE CUFFS **\$14.95**

CUFFS-2 STAINLESS HINGED DOUBLE LOCKING POLICE CUFFS **\$24.95**

CUFFS-3 LEG CUFFS **\$19.95**

CUFFS-4 THUMBCUFFS **\$9.95**



DPP2000
ELECTRIC PICK GUN
\$99.00

LPG-1
PICK GUN \$49.95



COLD STEEL CARBON V



RECON SCOUT--\$105.00



RECON TANTO--\$54.95



SRK--\$49.95

PLEASE WRITE FOR FREE CATALOG

SELF DEFENSE SUPPLY

AVENGER BLOWGUN



54 INCH BREAKDOWN MODEL INCLUDES 142 DARTS, AND ALL ACCESSORIES

\$29.95

NOT AVAIL. IN CA.



B3-1 HIGH POWERED CHINESE AIR GUN
.177 CAL. INCLUDES 200 PELLETS
\$29.95

Z-FORCE STUN GUNS ASSEMBLED IN USA

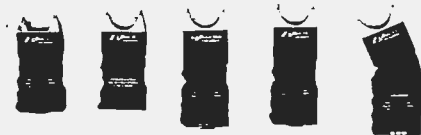

#ZF 1--80,000 VOLTS \$24.95

#ZF 3--100,000 VOLTS \$29.95

#ZF4--120,000 VOLTS

W/ DUAL COILS **\$34.95**

#ZF ULTRA 150,000 VOLTS

W/ DUAL COILS **\$39.95**

***STUN-ZILLA Z FORCE 6**

200,000 VOLTS **\$44.95**

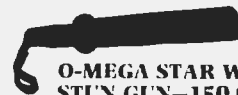

O-MEGA STAR WARRIOR STUN GUN--150,000 VOLTS
ENTIRE SHAFT IS ELECTRIFIED
THE MOST FRIGHTENING STUN GUN-EVER!
\$129.95

SPYDERCO



DELICA PLAIN EDGE \$29.95

DELICA SERRATED \$29.95

ENDURA PLAIN EDGE \$34.95

ENDURA SERRATED \$34.96

POLICE MODEL \$79.95

COMPLETE CATALOG INCLUDED WITH ORDER.

**MONEY ORDERS TO:
P.O. BOX 450717
GARLAND, TEXAS 75045**

EACH ITEM ADD \$5.00 S&H
TEXAS RESIDENTS ADD 8.25% SALES TAX

**MC OR VISA CALL:
(214) 414-1747
OPEN M-F 9-6 CENTRAL**

COLD STEEL



VOYAGER TANTO \$49.95



TANTO SERRATED \$49.95



VOYAGER CLIP POINT \$39.95



CLIP POINT SERR. \$39.95

NOT SECONDS

HOLY WARRIORS

Continued from page 39

Kashmir in advisory and leadership roles, starting in the summer of 1991. By that time it was clear that the Kashmir situation had grown from a few random bomb blasts into every Pakistani military intelligence officer's wet dream: a full-scale popular revolt against Indian rule. But there was a catch. In spite of the weaponry that ISI was having humped across the LOC, something in the human factor was lacking.

The colonial stereotype generally regarded Kashmiris as docile and submissive, good for weaving shawls and carpets but not a "martial race." A sweeping judgment perhaps, but certainly nobody ever accused Kashmiris of being natural born fighters in the Afghan, Sikh or Gurkha mold. This has been reflected in the pace of the current conflict.

By the end of August 1994, New Delhi admitted losing 867 men KIA in the conflict. Calculating from Janu-

ary 1990, this works out to less than 20 men per month. Even allowing for Indian underreporting, in the target-rich environment of Kashmir where you can't walk 50 meters without seeing an Indian soldier, this tells you something about the vigor with which 10,000-odd guerrillas are fighting.

The first Afghan advisers are believed to have come from the Hezb-i-Islami faction of Gulbuddin Hekmatyar. No surprise, given the Hezb's long and close relations with ISI. Equally unsurprising, Afghan instructors ended up operating with the Hezb-ul-Mujahideen, ISI's favorite Kashmiri outfit and effectively the sister party of the Afghan Hezb.

Phase three, the internationalization of the Kashmiri revolt, began in the summer of 1992 following the fall of the communist Najibullah regime in Kabul. The muj victory in Afghanistan had the effect of freeing large numbers of Afghan and foreign muj unenthusiastic about slaughtering other muj. On the streets of Srinagar, there was a real enemy — the idol-worshipping Hindu.

Over the late summer and fall of

1992 and into 1993 groups of Afghan veterans bussed from Peshawar to the Azad Kashmir capital of Muzaffarabad. Linking with returning Kashmiri militants, they then trekked the rugged LOC into Indian country. As had Afghanistan, the Kashmiri war attracted a geographically mixed bag, including Afghans, Pakistanis, Egyptians, Sudanese, Saudis, Libyans and Iranians. By summer 1993, Kashmir could lay fair claim to being the top international destination for the have-Kalashnikov-will-travel jihad tourist.

As far as Pak intel was concerned, the influx of Afghan vets was doubly useful. Politically and ideologically, it served to internationalize the conflict. No longer would India be in a position to claim the Kashmir problem was a little domestic quarrel. It was now demonstrably an international jihad.

At ground level, it gave the insurgency the extra boost it lacked, such as in ambushes. Typically, an ambush set by Pak-trained or local Kashmiris would involve the detonation of an improvised explosive device, ineffectual automatic fire from

TACTICAL SHOTGUN



**Act Now - Build Up
One of Your Own**

While You Can!!!

Tactical Grips - (front).....\$18.00
 (rear).....\$15.00
 Models to fit Mossberg 500 - 600; Remington 870;
 Winchester 1200 - 1300. Specify shotgun & front or rear.

Magazine Extensions
 7 shot for Remington 870, 1100, 11-87\$32.95
 8 shot for above Remingtons.....\$34.95
 10 shot for above Remingtons.....\$39.95
 7 shot for Winchester 1200, 1300.....\$32.95

Barrel/Magazine Clamps \$5.95
 2 different models fit all above guns. Specify shotgun.

QD Swivel - fits above clamps\$4.95

SideSaddle® Shotshell Carrier\$24.95
 Models to fit Remington 870, 1100, 11-87; Mossberg 500,
 600; Winchester 1200, 1300; HK Super 90. Specify gun.

Streamlight "SCORPION" Flashlight
 Super bright, focusing, push button end switch
 (includes 2 lithium batteries)\$39.95
Universal Barrel Mount #4
 Mounts Scorpion flashlight to shotgun\$19.95
Tactical Sling\$15.95

Moore Technical Industries

P.O. Box 86 - Dept SOF
 Bowling Green, MO 63334

We stock the entire TacStar® line of laser sights and shotgun accessories.
 We also carry other shotgun accessories plus Streamlight flashlights.
 Send \$2.00 for our complete catalog. Refunded first order. Free with order.

Sales and shipments to U.S.A. only.

Add \$5.00 shipping. Money Orders, Visa, MC, accepted.

Sorry - No COD's or personal checks.

Phone: (314) 669 - 5319

FAX (314) 669 - 5684

Professional Locksmithing Tools

LOCKAID

Specifically designed to pick tumbler locks. Designed over thirty years ago to aid law enforcement agencies. Consists of tension wrench, three needles and Lockaid "Gun." Prices include a copy of the book "Lock Picking Simplified."
Lockaid \$69.95



PIX MODEL 13

This deluxe yet compact kit features 11 of the most commonly used tools. Comes in a slim cowhide leather case for discreet undercover operatives. As a special bonus, a 5 piece set of warding picks is included. A 16 piece set total. Also included, a copy of "Lockpicking Simplified." Receive all this at a low price of:
Pix 13 \$42.95



PXP 8

- Shirt Pocket Size.
- Top Grain Cowhide Leather.
- Has 8 Picks, Tension Wrenches and Broken Key Extractor.
- All Picks with Metal Handles.
- Copy of Lockpicking Simplified.

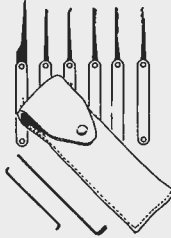

PXP 8 \$24.95

PXP 10

- Shirt Pocket Size.
- Top Grain Cowhide Leather.
- Has 13 Picks, Tension Wrenches and Broken Key Extractor.
- All Picks with Metal Handles.
- Copy of Lockpicking Simplified.

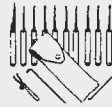

PXP 10 \$34.95

PIX-EZ All-In-One Pick-Set

100% American Made!
 As convenient to carry and use as a pocket knife!
 Only 4 inches long, half inch squares, weighs under five ounces, works fast and opens pin and wafer tumbler locks quickly, with very little effort. Six tempered spring steel picks, tension wrench.
\$34.95

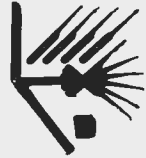

WKS PICKS

Made of the finest blue tempered spring steel this 5 piece padlock pick-set is a must in every locksmith's tool box. This set will pick open most every warding padlock made today.
\$9.95



Lockpicking Simplified	\$8.50
Complete Guide to Lockpicking	\$15.00
Improved Lock Picks	\$9.95
Tubular Locks	\$8.95
Lockout and forced entry	\$8.95
Involuntary Repression	\$10.95

Safe & Vault manipulation	\$9.95
How to Pick Pins & Wafers	\$9.95
Combination Locks	\$8.50
Keys by Impressioning	\$7.00
Key Casting Manual	\$8.95
Locks, Picks, Clicks	\$10.00



NEW MONTHLY SPECIAL

RECEIVE A COMBINATION SET
 INCLUDES — 5 ITEMS

1-MD-16 DELUXE SET	\$59.95
1-SCHALGE WAFER SET	\$27.95
1-SESAMEE DECODER	\$17.95
1-WKS PICKS	\$ 9.95
1-DOUBLE SIDED TUMBLER PICKS	\$27.95

**A VALUE OF \$143.75
 AT A LOW PRICE OF \$89.95**



ESP-13

This handy new pick set is the most popular set among professional locksmiths today. This kit consists of 12 different tools housed in a handsome black leather case designed for a shirt pocket. Included in the price, you receive a 5 piece warding key set and a copy of "Lockpicking Simplified." 17 piece set total.
ESP-13 \$45.95



KEY RING PICK SET

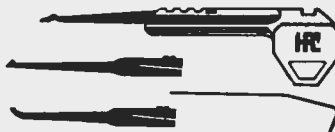

This unique design is ideal when low profile is required or to keep on your keyring for emergencies. Contains a tension wrench, three picks and the "Key Pick!"
Key Ring Pick Set \$27.95



DOUBLE SIDED DISK TUMBLER PICKS

Set of 4 picks designed to be used on the most popular double-sided disc tumbler, showcase, cam and padlocks.
\$29.95

MINI PICK TUBULAR

The most effective tubular pick on the market, unlike the larger picks with long handles or screwdriver handles. The longer the tool, the more pressure needed which causes easy breakage. The advantage of the Mini Pick is it is so short, you only use your thumb and index finger. With a little practice this tool will open a tubular lock in less than a minute.
 A. Your Choice: (1) Center (2) Offset left (3) Offset right; B. "Segal" 8 pin tubular; C. 5-pin Tubular; D. 6-pin Tubular; E. 8-Pin Ace.

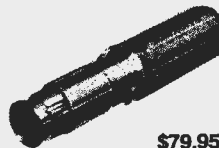

\$79.95

SESAMEE DECODER

This tool was designed to decode the exact combination of a sesame padlock without damaging the lock. Detailed instruction included.



\$17.95

SCHLAGE WAFER

The most fantastic tool you will ever use. This set consists of two base keys and pick. Complete instructions included.
\$29.95

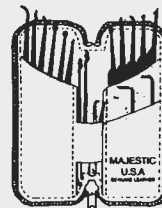

MD16

Shirt Pocket Size, Top Grain Cowhide Leather, Zippered Case, has 16 Picks, Tension Wrenches and Broken Key Extractor.
\$59.95

MD32

Hip Pocket Size, Top Grain Cowhide Leather, Zippered Case, has 32 picks, Tension Wrenches, Broken Key Extractor.
\$69.95

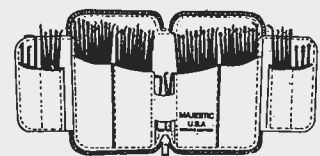
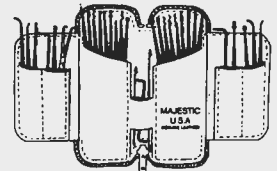

MD60

Top Grain Cowhide Leather, Zippered Case, has 60 picks, Tension Wrenches, Broken Key Extractor and Warded Master Keys.
\$99.95

Catalog \$3.00
 Free with order.
 Sorry, no credit card orders



The law requires all purchases be made in good faith, without make believe or fraud by genuine persons within this industry

Send to
**Steve Arnolds
 Gun Room**
 postage & handling
\$5.00
 Overseas Surface
\$6.00
 Add 30% of total
 for overseas mail.
 Must be 18 years
 of age.

P.O. Box 68, Dept. SF04, Dexter, OR 97431; (503) 726-6360

THE SMALLEST .45 ACP AUTO PISTOL EVER BUILT!

***.45ACP Double Action Only**

SAFE! WHILE READY TO FIRE

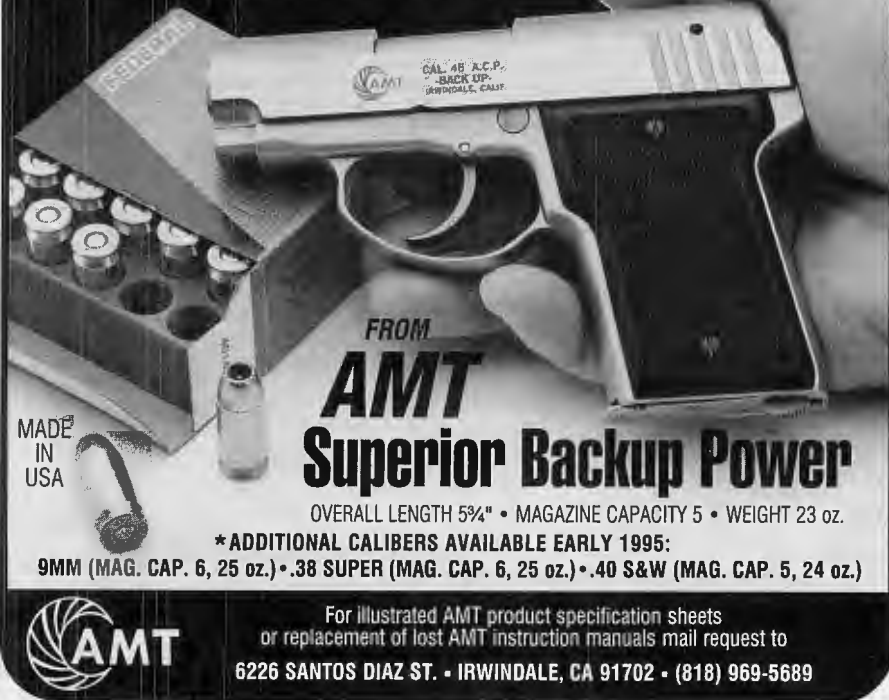

MADE IN USA

FROM
AMT
Superior Backup Power

OVERALL LENGTH 5 3/4" • MAGAZINE CAPACITY 5 • WEIGHT 23 oz.

* ADDITIONAL CALIBERS AVAILABLE EARLY 1995:
9MM (MAG. CAP. 6, 25 oz.) • .38 SUPER (MAG. CAP. 6, 25 oz.) • .40 S&W (MAG. CAP. 5, 24 oz.)

For illustrated AMT product specification sheets
or replacement of lost AMT instruction manuals mail request to
6226 SANTOS DIAZ ST. • IRVINDALE, CA 91702 • (818) 969-5689

considerable range and hasty withdrawal. Now Indian troops faced ambushes sprung from short range with RPGs and machine guns, where attackers actually stood and fought.

"People who generally went for training to Pakistan were trained for only 15 days," one senior BSF officer told me. "The caliber is very poor. The only difficult insurgent is the man who's been trained in Afghanistan. Frankly, I think they're the only ones worth fighting against."

Better Weapons

With the foreigners, upgraded weaponry was coming in, too — much of it surplus from the Afghan battlefield. I saw one Indian warehouse of captured arms sufficient to equip an infantry division.

In the early part of the insurgency, much of this consisted of the standard equipment shipped — via Pakistan's ISI — to the Afghan muj: Type 56 Chinese AKs and Type 69 Chinese RPG-7 equivalents. Since then the Kashmiris have gained access to the top shelves in the Afghan small-arms bazaar.

Since 1992 large quantities of RPD



At CAUSE Foundation we believe that Janet "child abuse really burns me up" Reno and her black booted henchmen of the BATF should not get away with Waco-like tactics against any more Americans.

WE want to make it very expensive for them to drive tanks over the Constitution and to set fire to the Bill of Rights.

In federal court, we have already filed suit on behalf of surviving Branch Davidian family members. We are suing Reno and every one else connected with this atrocity.

Send your most generous contribution to:

As a non-profit civil rights organization, we depend on donations from patriots like you. Our supporters are people who want to do something about these problems instead of just reading about them. Won't you join us? Let's make Janet think twice next time she cranks up her tanks.

CAUSE FOUNDATION
P.O. Box 1235, Black Mountain, NC 28711

**Help stop
Reno
and her
Gun
Grabbing
Goons**

VenomTM



THE MOST POWERFUL...THE MOST POTENT...THE MOST EFFECTIVE OFFENSE SPRAY AVAILABLE!!! We're serious about your safety, and nowhere is that more evident than in our line of Chemical Defense Spray VENOM. VENOM was developed to provide you with the highest degree of non-lethal protection available. VENOM is formulated to give optimum performance from each size unit. VENOM is fast acting and hard hitting, and is effective against even drunks, drug abusers, and psychotics.

- 3 Ounce Home/Auto Unit (Maxi-Blast top)\$24.95
- 3/4 Ounce Pocket/Purse Unit\$11.95
- 3/4 Ounce Keyring Unit\$15.95 (PLUS \$3.50 Shipping)

THE WORLDS FINEST SLIM JIM

Our premium quality car jimmy tool is made of high quality spring steel, with rounded edges and textured black rubber handle. Comes with instructions.

SJ100 \$9.95 (PLUS \$3.50 Shipping)

COBRA III+ ELECTRONIC LOCK PICK

"OPENS 99% OF ALL PIN TUMBLER LOCKS IN 7 SECONDS OR LESS"



SUPER HALOGEN BULB LIGHT UP ENTIRE KEYWAY

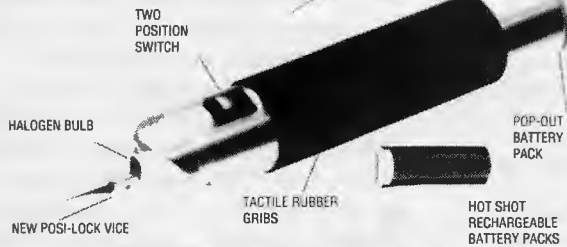

It's a technological dream come true! Finally, there's a fast way to pick open 99% of all pin tumbler locks in use today. All components are manufactured from aerospace aluminum alloys for a lifetime of quality, hassle-free service. The new Cobra III+ is jam-packed with all new features. Our exclusive high-intensity focused halogen key way light source; new tactile rubber grip; extra rechargeable "Hot Packs". The Cobra III+ is shipped complete with rechargeable Hot Pack wall charger, extra picks, tension tools, allen wrench, and shipping case.

Cobra III+ \$499.00
Comes complete in die cut shipping case (PLUS \$10.00 Shipping)

For our Florida customers, and our friends in law enforcement and military - write or call for a listing of our automatic collector's knives.

CLASSIC ITALIAN

INTERNATIONAL COMBAT SWITCH

THE SPIKE

Navy Seals II



MAXIMUM SHIPPING CHARGE PER ORDER - \$10.00
CHECK, MONEY ORDER, VISA, OR MASTERCARD
Full Line Catalog \$2.00



WARNING: Check State & Local laws regarding use & lawful possession of items above. Must be 18 years or older to order.

D100 SAP GLOVES



Made of soft, pliable deerskin, these gloves have 6 ounces of powdered lead inserted across the knuckles of each fist. Discreetly effective.

D100 \$69.95
D-50 (Cowhide) \$37.95 (PLUS \$4.50 Shipping)

LEATHER SLAPPER

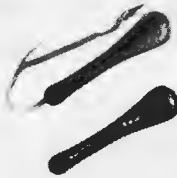

The highest quality slappers available. Constructed of smooth top grain cowhide with a leaded striking end. Available with or without a wrist loop. Made in U.S.A.
BBL520 \$19.95
BBL521 (With wrist loop) \$19.95 (PLUS \$3.50 Shipping)

POCKET PROTECTOR

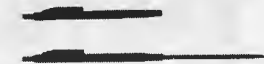

Press the pocket clip and a 4 1/2 inch long, 1/4 diameter spike extends from the body of the device, providing 10 1/2 inches of potent protection. Rugged, all steel construction.

GFR \$55.00 (PLUS \$4.50 Shipping)

BRASS KNUCKLES PAPERWEIGHT

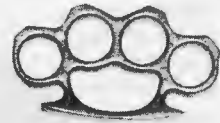

The finest product of its kind available—add a beautiful example of the metal worker's art to your collection.

KNB \$13.50 ea
KNA \$24.50 pr
KNA Lightweight Aluminum \$8.00 ea (PLUS \$3.50 Shipping)

Z-FORCE STUN GUNS



Z-FORCE stun devices are the best we've found! They offer reliability, high sustained voltage output and concealability - these devices are compact and powerful.

ZF-3, 100,000 Volts \$44.95
ZF-4, 120,000 Volts \$69.95
ZF-Ultra, 150,000 Volts \$99.95
SouthOrd Security +, 200,000 Volts \$119.95 (PLUS \$5.50 Shipping)

"ACE PICK" TUBULAR LOCK PICK



Opens vending machines, T-top locks, washing machines, etc. This precision tool is made of HIGH QUALITY, HEAT TREATED STEEL, and picks tubular locks with mushroom pins. Includes a decoder and is available for center or offset locks.

APC 7 (7-PIN) \$89.95
APC 8 (8-PIN) \$89.95
BOTH PICKS \$159.95 (PLUS \$5.50 Shipping)



BLACKJACK

These law enforcement weapons, once the standard of police officers throughout the country, are finely crafted from lead, steel spring, and leather. Eight ounces of nostalgic protection. Made in U.S.A.

BJK8 \$19.95 (PLUS \$3.50 Shipping)

PXS 14 LOCKPICK SET



This 14 piece set includes everything you need to open most locks and doors—an assortment of picks and rakes, two tension wrenches, a broken key extractor, and cowhide pocket case. Includes the book, Easy Pickins.

PXS14 \$32.95
PXS17 \$49.95 (PLUS \$3.50 Shipping)

SOUTHERN ORDNANCE

"The hardest hitting products in the personal defense industry"

P.O. BOX 279 • DEPT. SF • Babson Park, Florida 33827

FAX (813) 638-2486

(813) 638-2499

TACTICAL RESPONSE®

America's 1st Production "Practical" Shotgun

- Utility
- Reliability
- Accuracy

Used by Major Federal, State & Local Law Enforcement Agencies

Standard Model #90100 shown with patented TRAK-LOCK® Ghost Ring Sight System.



- New Shotguns
- Customer Conversions
- Replacement Parts
- Accessories

We offer 17 specialized models built on new "Police Grade" Remington 870 and 1187 12 gauge shotguns. Customer provided shotgun conversions are encouraged. For more information send \$3.00 for our new catalog with price list. Logo wear available: S/S Shirt \$15.00, L/S Shirt \$19.00, Baseball Cap \$13.00. Please specify size.

SCATTERGUN TECHNOLOGIES INC.

P.O. BOX 24517R • NASHVILLE, TN 37202 • 615-254-1441 • FAX 615-254-1449

and RPK machine guns have reached Kashmir, along with the Soviet PK. In addition there has been a lesser but significant flow of SVD Dragunov sniper rifles, 5.54x39mm AK-74 rifles, along with the shorter AKR "Krinkov." The BG-15 rifle-mounted 40mm grenade launcher (parallel to the U.S. M203) is also now seen.

In commo, the militants benefit both from commercial walkie-talkies as well as the more sophisticated frequency-hopping, burst-transmission radio equipment ISI used to give to its special friends in the Afghan muj.

By summer of 1994, Indian intel estimated more than 1,000 foreign muj had infiltrated Kashmir. Many of them were operating in a new organization called *Harakat-ul-Ansar* (Movement of the Companions of the Prophet), formed in late 1993. While it includes Kashmiris in its ranks, *Harakat-ul-Ansar* is mostly a foreign organization, fighting as an international brigade. Along with *Hezb-ul-Mujahideen*, it benefits from close links to religious groups based in Pakistan and by extension with ISI. Today, these two factions represent the sharp end of the Kashmiri jihad: the best armed, most committed, most aggressive.

To date, terrain along the LOC has worked in India's favor. The inability of horse caravans to cross the closely picketed LOC has been a critical factor in preventing a replication of an "Afghan strategy" in Kashmir. The militants have been unable to transport the heavier, stand-off weaponry that cost the Soviets and their allies so dearly in Afghanistan. The 107mm and 122mm rockets, recoilless rifles and 82mm mortars that mauled so many communist bases in Afghanistan have been conspicuous by their absence in Kashmir.

Politically, attempts to revive the electoral process in the state — since 1990 under direct central rule — have met with no success. Militarily, meanwhile, the guerrillas gain experience and sophistication. India is bracing for a further influx of foreign muj and an intensification of the conflict in 1995.

India has all it takes to hold Jammu and Kashmir as long as it wishes, but faces a danger that the virus of religious radicalism will spread into the nation's sprawling urban centers. India is home to 130 million Muslims, many already worried by aggressive Hindu fundamentalism. Radical Is-

SWITCHBLADE - AUTOMATIC KNIFE COLLECTORS



The Automatic Knife Resource Guide and Newsletter

A unique publication for the automatic knife enthusiast, now in its FOURTH YEAR! Terrific photos, in-depth articles, maintenance and repair tips, the LATEST trends, resources for ALL kinds of automatic knives, free classified ads and much, MUCH, MORE! Send \$10. for single issue or \$30. [\$36. Foreign] for a one year (4 issue) subscription to: THE NEWSLETTER, 2269 Chestnut Street, Suite 212-A, San Francisco, CA 94123, USA. Phone/Fax: 415-731-0210.

H-S Pro-Series Tactical Rifle Special

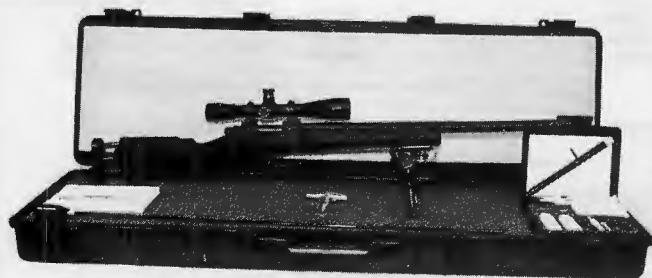

FREE BONUS PKG

with rifle purchase
\$400 value
Case - Cleaning Kit
Wrench - Log Book
Harris Bi-Pod

\$3,200.00
Limited Time Offer

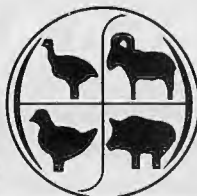

H-S PRECISION, INC.

1301 TURBINE DRIVE
RAPID CITY, SD 57701
(605) 341-3006

ENGINEERED FOR ACCURACY

- *Pro-Series* Match-Grade SS Barrel Cut-Rifled, Fluted 308 24" long
- *Pro-Series* Tactical Stock Adj. LOP, Full Bedding Block Kevlar/Graphite
- *Leupold Mark4* Scope, 10x or 16X
- *Accurized* Rem 700 BDL, RH 308 Cal.

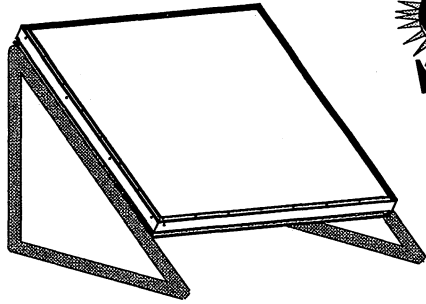

SunPure™ Drinking Water Systems

The System That Works - Like Nature

SURVIVOR SERIES

SunPure's SURVIVOR SERIES Drinking Water Systems provide life-saving, potable water from any source water—using energy from the Sun. Just place the SunPure panel outside, gravity fill it with source water and let nature purify your water for you. The SURVIVOR SERIES panels are sloped-basin solar distillers capable of up to 2 SunPure gallons/day/panel. You can use water from any source: Rivers, Streams, Ponds, Swamps—Even Sea Water!

The Base Camp -

The SunPure Base Camp is designed for semi-permanent installations. It has a sturdy aluminum frame, tempered-glass solar glazing and comes with its own stand. Each panel comes with two collapsible fresh-water jugs. Approximate weight: 51 lbs. Dimensions: 48" x 48" x 4" Order Base Camp Model #SPF-C48.

The Safari -

The SunPure Safari is a ruggedized version of the Base Camp to be used as a temporary camp model. The panel cover folds out to become the unit's stand. Impact-resistant acrylic glazing is used for safety and durability. Approximate weight: 44 lbs. Dimensions: 48" x 48" x 5" Order Safari Model #SPC-C48.

The Traveler -

The SunPure Traveler is a fold-up solar distiller in a self-contained travel case designed for high mobility. It can be set up or taken down in minutes and provides an average of 1 gallon/day of pure potable water. As with all SunPure distillers, any source water can be used. Approximate weight: 23 lbs. Dimensions: (Open) 60" x 26" x 5"; (Closed) 30" x 26" x 10" Order Traveler Model #SPC-C24.

SunPure Drinking Water Systems are also available for homes. Plus, SunPure has salt water desalination systems for entire communities, as well as island-based homes.

To Order Your System, Call: (800) 590-0090

SunPure Division of HommeCorps Inc.

Dept. 04N95, P.O. Box 1725

Lyons, CO 80540

Voice: (303) 823-0118

Fax: (303) 823-9215



SunPure™ Drinking Water Systems

A Division Of

HommeCorps

Incorporated

Products for Mankind

COUNTERFEIT GUNS

that are inexpensive to own and safe to display in your home. They are realistic, full size working metal models that look, feel, weigh and handle like the expensive originals. You can work the action, release the clip and dry fire these high quality models.

CANNOT BE FIRED!

ISRAELI UZI SUBMACHINE GUN
Used by Israeli troops in the historic 6-Day War, the Entebbe Raid. Adopted 30 other nations as the most successful sub-machine gun on the market today.

Over 72 parts folding metal stock detachable 32-round magazine. Length 25" Wt. 9 lbs.
#01-705M.....\$310 PPD

Exact Replicas in Metal!....

1921 THOMPSON

as used by FBI & U.S. combat troops. Over 59 parts, including vertical foregrip, detachable wood butt-stock & 20-rd. magazine. Lgth. 35". Wt. 9.5 lbs. Disassembles like original.

#01-700\$299 PPD

Full size (non-firing) models look, weigh, and handle like the originals.

M-16 ASSAULT RIFLE

The ultimate defense arm as used by S.W.A.T. forces. Made famous by U.S. troops in S.E. Asia. Full size. Bolt functions like original—over 70 ABS plastic and metal parts. CANNOT BE FIRED. Lgth. 39". Wt. 5 lbs.

Declared "non-gun" by the Federal Gov'l.

#39-2707.....\$300 PPD

FULLY ASSEMBLED

U.S. 45 AUTOMATIC

A favorite of GI's for 80 yrs., from WWI to Vietnam. This metal "non-firing" replica model is exact in every detail—even the grip safety works. Blued finish. Can be disassembled. L: 8.5" W: 2.5 lbs. #01-300

\$107 PPD

M92 AUTOMATIC

This massive 9mm was chosen to replace the .45 auto. Made famous in Operation Desert Storm, this blued "non-firing" metal model actionworks like the original. Can be partially disassembled. L: 8.5" W: 3 lbs. #22-1254.....\$102 PPD

COLLECTOR'S ARMOURY

800 SLATERS LANE, DEPT. SO
BOX 59, ALEXANDRIA, VA 22313

Not sold to Calif. except for theatrical use.

SEND: SEND FREE CATALOG
Credit Card Orders: 1-800-544-3456 Ext. 515

NAME _____

ADDRESS _____

CITY/STATE/ZIP _____

MONEY BACK (LESS POSTAGE) IF NOT SATISFIED

lamic organizations exploit those fears, recruiting urban Muslim youth. If the new jihad spills beyond Kashmir, India may well attack Pakistan as the external source of her trouble.

The danger for the world community is that, having gotten into previous inconclusive wars over Kashmir, if the Indians and Pakistanis get into another punch-up — this time both sides have nukes.

Bangkok-based photojournalist Mike Winchester has covered most of Asia's combat arenas for SOF. ☒

SECRET ARCHIVES

Continued from page 47

tries of the Warsaw Pact — which was the fate of more than 200 American POWs in the Korean War — the author obtained exclusive confirmation from members of the Pentagon's Task Force Russia, that the Russian Ministry of Security (the former KGB) consistently stonewalled the American members of the much-touted Joint Commission to investigate the presence of POWs in the USSR. Moreover, Task Force Russia members confirmed that between three and 10 "very high skill" American POWs were probably transported from Indochina to disappear into the former USSR during the Vietnam War.

Despite SRV denials, "retired" PAVN officers have continued to engage in the lucrative business of hoarding and releasing skeletal remains of U.S. POWs — which they sell for more than \$10,000 a set. Further, the author's pattern analysis shows that the eventual fate of a missing man was a function of his loss location, not the type of aircraft he flew or his technical specialty: The closer to Hanoi a man was lost, the better his chances of returning as a live, repatriated POW, but the farther from Hanoi, the more likely he would become an MIA.

The book provides a unique analysis of the two sensational GRU (former Soviet army intelligence) documents unearthed in Moscow last year, which seemed to indicate the SRV held as many as 600 U.S. POWs more than they ever admitted. Al-

though these documents have been used by POW/MIA activists to prove that hundreds of American prisoners remained in Indochina after the war, the book shows how the documents actually refute each other and concludes that they are probably both erroneous — characterized in intelligence parlance as "flawed agents' reports."

The author's detailed analysis of secret Hanoi archive documents and photographs reveals not only that amazingly extensive PAVN records were kept on all the aircraft shot down in the populated areas of North Vietnam, but that all of these crash sites were "mined" for the gold and platinum to be found in the engines and avionics (one fighter-bomber would yield up to \$5,000 in gold). Therefore, it is obvious that the Vietnamese do in fact have detailed information on the fates of more than 100 U.S. airmen (like Pogreba) who were lost in these areas, but about whom they have denied any knowledge for years.

McConnell also cuts like a laser through bogus MIA activist claims that the U.S. government wittingly abandoned hundreds of American POWs in communist hands. He not only puts the conspiracy myth to rest, but also documents the unsavory background and questionable activities of many "Rambo Faction" activists, showing their true motivations to be publicity and greed.

Additional light is shed on the case of Marine turncoat Bobby Garwood. PAVN officers spoke freely to the author and Ted Schweitzer about him, stating that after Garwood joined the communist side, he was treated well and would have remained in Vietnam permanently, if he had been allowed to join the Vietnamese Communist Party — the route to financial success. But when his party application was finally refused, he decided to return to the United States.

McConnell knows his subject well, as is evident from the very first chapter, and makes a rock-solid contribution toward solving the MIA mystery. This book is must reading for anyone interested in Vietnam, and is highly recommended for layman and scholar alike.

F.C. Brown has followed the MIA issue for 25 years and authored POW/MIA Indochina: An Annotated Bibliography (3rd edition). ☒

THE ISRAELI CHALLENGE TRAINING PROGRAM

MARCH 26 - APRIL 9, 1995

INCLUDES ALL OF THE FOLLOWING – PLUS MUCH MORE!

Complete Israeli SCUBA Diver Training OR Israeli Skydiver Training • Sharp Shooting And Target Range Practice • Topography Courses • Navigational Training • Krav Maga (Hand To Hand Combat – Israeli Commando Style) • Desert Survival • Knife Fighting • Elite Intelligence Gathering And Covert Operations Training • Escape And Evasion Training • Anti-Terrorist And Hostage Crisis Situation Training • Emergency War Medical Training • Jeep Safari • White Water Rafting • Rappelling And Mountain Climbing • Bedouin Dinner Experience In The Judean Desert

FEW SPACES LEFT – REGISTER NOW FOR THE EXPERIENCE OF YOUR LIFE!

Touring of Israel in deluxe air-conditioned motor coaches throughout the entire program

Complete package -
Including round-trip
air transportation from
New York –
\$ 3,850 per person

Land package only –
\$ 3,100 per person

**GROUP
DISCOUNTS
AVAILABLE**

SPACE IS LIMITED
To receive a free information
package – CALL NOW!

- TEL (708) 541-8090
- FAX (708) 541-8092
- Internet E-Mail: 74150.271@compuserve.com

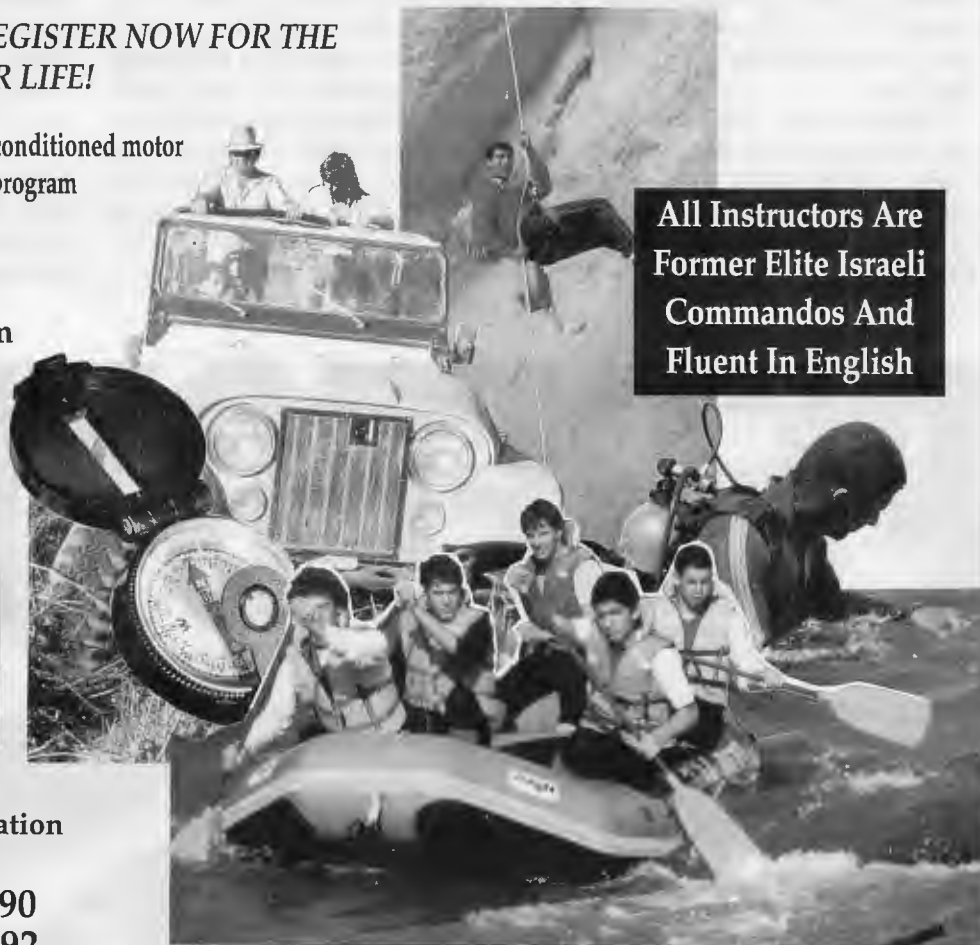

**All Instructors Are
Former Elite Israeli
Commandos And
Fluent In English**



הקשר האווירי הישראלי בע"מ
THE ISRAELI SKY CONNECTION LTD.

OUR 2ND YEAR

COMBAT WEAPONCRAFT

Continued from page 30

times surpassed, the CAR-15 on all drills from close range out to 150 yards. Even where multiple targets were engaged, the lever gun matched the performance of the CAR-15. The only difference was noticed on multiple targets at very close range (within 10 yards). Here the CAR-15 was slightly faster than the lever action — one-quarter to one-half second. Is this enough difference to discount the lever action? No. The man with the lever gun has to work harder, but with sufficient practice I'll bet the lever action won't be measurably slower than any rifle.

Ergonomically, the lever gun was noticeably handier than the CAR-15. It is more streamlined, with no projecting magazines, pistol grips, sight platforms or bells and whistles. It is much easier to

dismount a vehicle with and doesn't catch on doors, seat belts, or brush as does a CAR-15.

After a detailed evaluation I am convinced the lever action is a viable alternative to autoloaders as an urban rifle. This will be no surprise to students of Jeff Cooper, who long favored the lever action as the ideal police rifle.

I predict that the coming years will witness a resurgence of the lever-action rifle as a self-defense weapon. Make no mistake: A good man with a gun will be able to handily sort out his enemies armed with either a CAR-15 or a Trapdoor Springfield. What the lever-action did more than a century ago, it can do today. So if you cannot afford a military style rifle or are afraid to bring your collectible into the field — don't despair. Get yourself a politically correct "assault rifle" and save your AR, Steyr or H&K for the big one. As Dr. Naish Piazza of the Front Sight Firearms Training Center is fond of saying, "Any gun will do, if *you* will do!"

Gabriel Suarez is on the special ops unit of a California police department and a graduate of Jeff Cooper's Gunsite. ☞

FAST AND THE DEAD

Continued from page 57

fire. "We couldn't shoot at sounds," Isaacs said, "We had to see the gunner and the gun before we could open fire."

Had he fired he would have had to explain his actions to State Department personnel who prepared detailed accounts of every round that was fired in Somalia. "I'll never forget the day when some bullets hit the wall of our compound, and one of our guys returned fire," Isaacs said. He watched other members of his platoon form a convoy and provide an armed escort for a State Department official who searched the grounds outside the compound in "no man's land" for left-over brass the Somalis might have left and for any craters in the dirt the Marines' M16A2s might have made.

PERFECTION

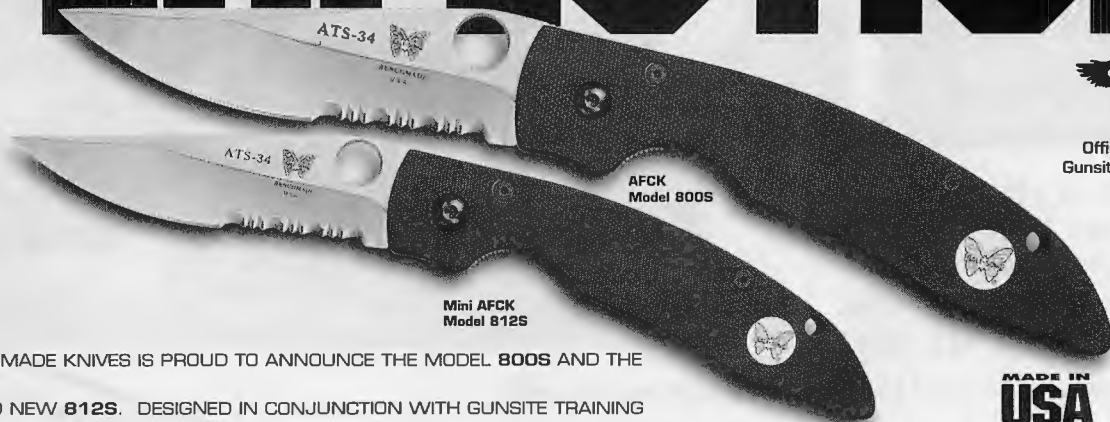

Official knife of the
Gunsite Training Center

Mini AFCK
Model 812S

AFCK
Model 800S

MADE IN
USA

BENCHMADE

FOR A COMPLETE BENCHMADE PRODUCT BROCHURE

SEND \$2.00 (SHIPPING AND HANDLING) TO:

BENCHMADE KNIFE COMPANY INC.

15875-G S.E. 114TH AVE.

DEPT. 5-F

CLACKAMAS, OREGON 97015 U.S.A.

OR CALL 503-655-6004

BENCHMADE KNIVES IS PROUD TO ANNOUNCE THE MODEL 800S AND THE BRAND NEW 812S. DESIGNED IN CONJUNCTION WITH GUNSITE TRAINING CENTER'S INSTRUCTOR CHRIS CARACCI. THE MODEL 800S IS THE OFFICIAL KNIFE OF THE GUNSITE TRAINING CENTER.

DEMAND THE BEST !

DEMAND BENCHMADE !

* MODEL 800 MADE IN THE U.S.A. BY BENCHMADE KNIFE COMPANY UNDER LICENSING AGREEMENT WITH SPYDERCO* INC.

Isaacs and his mates laughed as the "techno" crawled around the ground on his hands and knees looking for physical evidence of the shooting. Can you imagine having to document every round fired in Vietnam?

Before each platoon was deployed to Somalia on a four-month tour, it was put through what Paulovich calls: "Urban Operations Under Restrictive Rules of Engagement, the Shoot No-Shoot Scenario." Marines in Somalia operated under normal peacetime Rules Of Engagement (ROE) where you had to see hostile intent or hostile actions. But Marines also looked at what's called Temper and Intent (T&I), something that is not contained in the ROE.

Under T&I, Paulovich gave his Marines the authority to fire if someone pointed a weapon at them. Several Somalis learned that lesson the hard way. Lance Corporal John Barwell was involved in one of the first shooting incidents involving 2nd Platoon. Escorting the ambassador down 21 October Road, someone opened up with a 14.5mm heavy machine gun. Barwell spotted a Somali gunman in the upper window of a

building aiming his weapon at the convoy. Without any hesitation, Barwell fired four rounds as his HMMWV sped down the highway, neutralizing the man in the window.

Fort Apache

Occasionally, Ambassador Simpson would visit warlord Mohamed Aidid at his residence about one kilometer from the U.N. compound where FAST was quartered. But Bartholf and his men never accompanied the ambassador. "At any given time, there might be 300 of Aidid's armed men around his residence, and if we showed up, our mere presence would have started a fight," Bartholf said.

However, Bartholf had a plan in case the ambassador got into trouble: "We lined up all seven of our HMMWVs at the gate nearest Aidid's villa, five Marines in each. In the ambassador's armored limousine we put our explosives." Bartholf's battle plan called for tear-gassing the entire city block where Aidid lived, and then "firing-up" the house before they went in.

"We couldn't pussyfoot in there and hope to survive," Bartholf, a com-

bat veteran of the Gulf War, said. "We were going to do a mechanized urban assault to rescue the ambassador whether he was dead or alive. Simpson knew if he got his ass in a crack, 2nd Platoon would come and get him or we'd die trying."

Bertholf isn't easily stressed, but he really got uptight every time the ambassador went to see Aidid. State Department personnel were supposed to check in via radio every 15 minutes to let Bertholf know everything was well. They were allowed two missed "comm" checks before Armageddon began. They would occasionally run down the shot clock with two minutes to spare before "Key-stone," the regional security officer, would acknowledge to "Fast-Six" (Bertholf) that everything was fine.

Every platoon that deployed to Somalia called themselves, "The Alamo Detachment," because behind the walls of their compound they felt like Davy Crockett's men. But the Somalis didn't have enough soldiers or firepower to storm this modern-day, reinforced-concrete Alamo. Six blockhouses, one on each corner of the compound and two in the middle,

**New
And
Unique!**

**Hear Every Syllable!
They Never "Cut Off"!**

**Binaural to Know
Direction and Range!
(Forget Stereo)**

**High Amplification!
Up to 40dB!**

**Input Plug for Police
Radio And/OR Life Finder!
Includes NICAD Batteries
& Chager!**

Binar 20/40



Suggested Retail: \$169.95

For Your Free
Catalog, Contact:
Life Finder, Inc.
1311 North Memorial
Parkway Suite 100
Huntsville, Alabama
35801-5903

||||| LIFE FINDER |||||

CAN

FIND IT!

**Another Piece of Equipment
No Officer Should Be Without!**

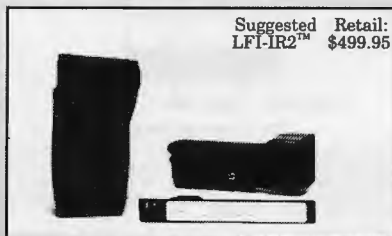

Suggested Retail:
LFI-IR2™ \$499.95

Has Found:

People Through Smoke Suspects Hiding in Woods
Hidden Fires Body Parts at Wreck Site
Buried People (15' Deep) Hot Cars in Car Lots

Works From:

Helicopters Ultralights
Moving Vehicles Hand Held on Ground

**Tested By U.S. Military at Over 3000 Feet
in Open Area, and Through 300 Feet of Woods.**

**New
Technology
Delivers!**

**New Target Systems
For Portable or
Permanent Installations!**

**Now Everyone Can
Have A Range!
Quick Setup (30 Min.)
Electronics in Rain
Tight Box!**

**Bullet Proof Shield on Top!
Pop-Up, Turning,
Swing Arm, & Running!**

Target Systems

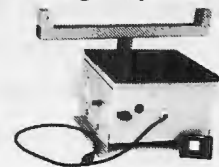

Call for Pricing

Or Contact By:
Phone: (205) 533-5004
Fax: (205) 536-3663

Orders Only:
(800) 459-FIND

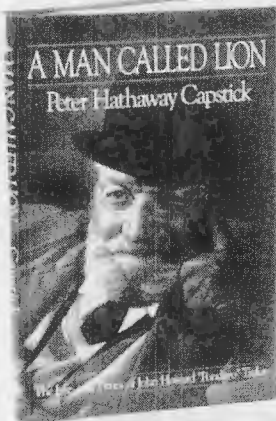

New book from Peter H. Capstick!

A MAN CALLED LION:

The Life and Times of John Pondoro Taylor.

Capstick tracks this controversial character from his encounter with the Sinn Fein in Ireland, his smuggling in Canada, his ivory poaching in Africa, to his final and depressing days in London. John Taylor was famous for his incredible knowledge of ammunition and rifles and their use in the African bush, and was the author of four popular books on the subject. This is Capstick at his very best on one of Africa's most intriguing characters. \$24.95



US & Canada (800) 451-4788 in CA (714) 894-9080
SAFARI PRESS, Inc. (add \$3.75 postage)
PO Box 3095-MSF951, Long Beach, CA 90803

Rifles & Carbines

The Heckler & Koch Assault Rifles

HK Assault Rifle Systems by Duncan Long

The tough G3 rifle and its huge number of spinoffs has long been a favorite of soldiers, policemen, and civilians. Now firearms expert Duncan Long reveals the little known history behind this fascinating family of weapons, tracing its beginnings from the ashes of WWII to the present. The book goes on to show the probable direction HK designs will take in the future and tells why the G3 and its variants will remain popular during much of the next century. The author also examines customized versions of the .308, .223, and 9mm rifles and submachine guns and semiauto versions as well as other chamberings of the G3 spinoffs (like the HK-91/93/94, SR-9, SAR-3/8, SP-89, etc.). 8 1/2"x11", 128 pages, illus., soft cover

Item No. C-9013.....\$27.95

HK 91 & 93 Factory Manuals

Yes, here it is! A 52 page detailed manual for your HK rifle. You have just purchased a new or used rifle and did not receive a manual. This one covers operations, maintenance, accessories, etc. Many illustrations, photos, and explanations. 7x8.5, illus, 52pp, softcover. Must specify Model 91 (G3) or 93(HK 33) when ordering.

Item No. C-403 (HK 91, .308).....\$15.95

Item No. C-404 (HK 93, .223).....\$15.95

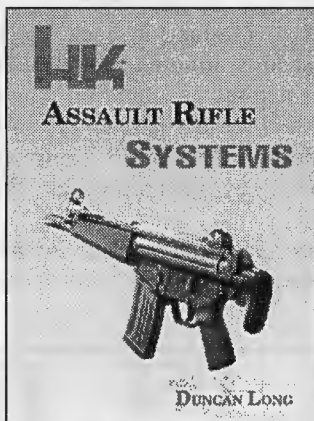

The Garand & M14

The Fighting Garand

Everything a Garand owner or user will ever need to know. 8 1/2"x11", softcover, illus.

Item No. C-136.....\$11.95

The M-14 Rifle

This book is a must for anyone who owns an M-14 or its civilian counterpart. Springfield Armory's great M1A1. 8 1/2"x11", softcover, 50pp., illus.

Item No. C-135.....\$8.95

M14/M14A1 Rifles & Marksmanship

This manual contains a detailed description of the M14 and M14A1 rifles and their general characteristics, procedures for disassembly and assembly and much more. 236 pp., indexed, 8 1/2"x11", soft cover.

Item No. C-274.....\$14.95

The SKS Carbine



The SKS Type 45 Carbine by Duncan Long

The SKS is an enigma in the world of assault weapons. Did it gain its place on the battlefield because of politics or performance? Has it survived because it is cheap to construct, or does it stem from its functionality and reliability?

Duncan Long reveals the answers to these questions and many more, beginning with the history of the SKS and advancing to the practical aspects of operating, maintaining and modifying this abundantly available rifle. 5 1/2"x 8 1/2", 110 pages, photos, and softcover.

Item No. C-9047.....\$14.95

More Rifles & Carbines

C-211 FN-FAL Auto Rifles Manual \$13.95

Illustrated, photos, 5 1/2"x8 1/2", 130 pages.

C-822 Mini-14 Super Systems \$16.95

Illustrated, photos, 5 1/2"x8 1/2", 189 pages.

C-333 USMC AR-15®/M16A2 Man. \$16.95

Illustrated, photos, 8 1/2"x11", 264 pages.

Credit Card Orders Only call our
Toll-Free Order Line
1-800-852-4445

Customer Service
1-501-862-4984

Fax Number 1-501-862-9671

Allow 2 weeks for delivery



Call for dealer info.

Add \$4.95 S&H to all orders plus an additional \$3.00 for orders to Canada. Other foreign add \$12.00 for first item & \$2.00 for each additional item.

Send Check or Money Order to:

DELTA PRESS
P.O. Box 1625 Dept.SF43
El Dorado, AR. 71731

Send \$4 for a 80 page color catalog (Free with order)

plus a reinforced bunker complex atop the barracks, provided the compound's primary defensive positions.

After the 1983 Marine barracks bombing in Beirut, walls around U.S. Embassy compounds worldwide were reinforced. Admiral Bobby Inman conducted an anti-terrorist study and found them so porous you could practically punch holes in them with your fist. The new, so-called "Inman Walls" of the compound in Mogadishu were 8 inches of super-strength concrete reinforced with 1-inch rebar. Not Somali concrete, only concrete made in the United States was good enough.

During mid-September 1993, a company of U.S. soldiers from the Army's 10th Mountain Division was conducting a clearing operation about 200 meters in front of the FAST perimeter. All of sudden, the troopers stumbled into a hornet's nest and couldn't disengage. They tried to back out by slapping a satchel charge against the Inman Wall around the U.N. compound and blowing an escape route. Someone forgot to tell them that the wall couldn't be breached with charges, and when troopers lit the fuse it blew back in their faces.

The Marines received permission to bring their heavy weapons to bear on SNA targets. Two bursts of Mk19 fire silenced the enemy positions. A few rounds of .50 caliber convinced other Somalis in the area that the game was over. Individual targets were taken down by Marine snipers crouched behind the wall as if they were on the rifle range.

These walls were strong enough to deflect anything the Somalis had in their inventory: artillery, recoilless rifles or RPGs. That's why the Marines who defended the compound never feared a Somali assault. "I don't think any one clan had enough firepower to do that," Bertholf said. "And the clans were never unified enough to team up on us."

The fact that clans were not unified didn't diminish the danger. Clans fought each other in full view of Marine bunkers along the walls of the compound. RPGs and recoilless rifle rounds would occasionally fly over the Marine barracks.

"We were lucky we didn't get hit in the crossfire," Bertholf said. Militiamen from Hebr Gedir, Aidid's

clan, tried unsuccessfully to torch "Hooterville," a shantytown that had sprung up a few yards from Post Five on the wall of the U.S. Embassy compound. But Marines had no trouble getting a decent night's sleep. The clans fought most of their battles in broad daylight, nine to five, and then buzzed out on khat, a narcotic they imported from Ethiopia, in the evening.

Turn Out The Lights

If you wanted to do something in Somalia, you did it early in the morning while Somali gunmen were sleeping off their khat buzz — and the earlier the better. That's why 2nd Platoon lowered the Marine Corps flag at 0600 hours, 15 September 1994. An hour later, at 0700, Bertholf's platoon stood at attention as the Stars and Stripes were lowered for the last time in Mogadishu. Ambassador Simpson thanked each of the Marines for their service, but said it was time for the United States to relocate its liaison office to Kenya where it would keep track of Somali affairs from a safe distance.

At 0730 hours, two white U.N. helicopters airlifted 2nd Platoon to the international airport for a flight to Mombasa, Kenya, aboard a Southern Air Transport L-100. Due to the political nature of the situation in Somalia, FAST was required to maintain guard over the housing compound right up until the moment it was turned over to Pakistani peacekeepers.

Sergeant Mike Tracey and Lance Cpl. Robert Tisdale were the last Marines to leave the U.N. compound. After constructing 30 major defensive bunkers, stringing over 200 miles of concertina wire, filling more than 100,000 sandbags and escorting 500 convoys, it was indeed over for FAST.

FAST Company fired only 270 rounds during six single target engagements, one major unit engagement, and four convoy ambushes. One hundred of the 270 rounds were fired in relief of the 10th Mountain Division. One hundred thirty-eight other rounds were fired at the infamous K-4 Circle incident. During single target engagements virtually all rounds hit home. In other words, one shot, one kill, though no one stopped to count bodies.

In fact, Tisdale was the only Marine in 2nd Platoon to get a "con-

GUNRUNNER®



READY WHEN YOU

want to draw your gun from the "Uncle Mike's" GunRunner® Fanny Pack Holster, just pull sharply on the front to release Velcro® strip that seals the firearm inside the rear compartment.

Compact GunMate Belt Pack Holster has rear gun compartment, center pouch for wallet and front pocket for badge, etc. Only 7³/₄" x 4³/₄" x 1¹/₂".



See them at your gun or sporting goods dealer. Or send \$2 for our new 48-page catalog to Michaels of Oregon, Dept. SOF, P.O. Box 13010, Portland, OR 97213.

SET GRASP THE GUN INSIDE

the compartment. There's no inner holster to slow you down. Three sizes fit a wide variety of guns. Five colors avoid a pattern of recognition.

GO! DRAW THE GUN SWIFTLY,

straight out of the GunRunner. When you reholster, just shove the gun inside, slap the Velcro shut, all with one hand. Middle compartment for ammo and gear, front compartment has badge holder.



TITANIUM

"The COMPETITIVE edge. . ."SM

\$34⁹⁵ Fits AR-15 & M/16 style Rifles

\$21⁹⁵
Fits 1911 pistols
.45 ACP &
.38 Super



You have already discovered the advantages of our Titanium Firing Pins for 1911 pistols. NOW YOU CAN ADD THE SAME MAGIC to your competition AR-15® & M/16®.

Proudly Made in the U.S.A.

Improve scores, reduce slam fires, discover what QUICK really means! Cut lock time . . . & get on to the next target!

Retail order desk:
1-800-444-1911
(Add \$3⁰⁰ S/H per order)



Quality MachiningSM
INCORPORATED

"OUR NAME SAYS IT ALL"SM
P.O. Box 129 • Sherwood, Oregon 97140

24 HOUR FAX LINE FOR ORDERS & DEALER INQUIRIES: 1-503-590-3636
(Product Information: 1-503-590-3636)

firmed kill." The Somalis made a claim against the U.S. government for the thug he shot. They wanted \$1,000 in damages, but according to Tisdale's CO, "They're still waiting for the check."

Guess who the U.N. secretary-general wants to bring back to cover the final U.N. withdrawal? The U.S. Marines.

Dale B. Cooper is a foreign correspondent and frequent contributor to SOF. He has covered U.S. involvement in Somalia extensively. ✕

KATONA

Continued from page 59

ous. An NBC news correspondent came right out and asked what everyone knew: Wasn't the congressman suddenly taking this pro-gun, anti-ATF stance just before the election to save his miserable hide from angry gun owners back home?

Of course not, Brooks blustered,

strutting up and down and making vows about what he was going to do "about rectifying the situation [with ATF] next Congress. I guess the Bill of Rights is not part of their reading material. But it will be when I get finished looking at their operations ... I am here to announce that time has run out on a runaway agency ..."

Alas, time ran out first for the career of a political dinosaur whose betrayal of his constituency cost him his job. The Republican candidate, Steve Stockman, won handily with 52% of the votes cast.

Mad As Hell

The ATF, meanwhile, is still running as corrupt, brutish and imperious as ever, thank you. The two leaders of the Waco attack got their jobs back on Christmas Eve (see this issue's "Bulletin Board"). A serious effort to slash the ATF's budget was headed off by Undersecretary of the Treasury Ron Noble, one of the main architects of the government's Waco cover-up. Noble violated federal law by lobbying Congress on pending leg-

islation — the ATF budget.

This is not to say that the new, Republican-controlled 104th Congress will not hold hearings on the pervasive police-state tactics of the federal law enforcement bureaucracy. But hearings before summer are unlikely, and hearings on wrongdoing by the ATF, FBI and other federal law enforcement agencies will not occur at any time without the constant and continued complaints of citizens like you.

Never give up resistance to tyranny: Organize call-in campaigns, not just to your own representatives, but to Rep. Hyde, and to the chairman of the Senate Judiciary Committee, Utah Republican Orrin Hatch (U.S. Capitol switchboard: 202-224-3121).

Call the committee offices and find out who the other members are and call them, too. Write letters. Send faxes. Tell 'em you're mad as hell and you're not going to take it anymore.

James L. Pate is SOF's pitbull against government corruption and abuse. ✕

MilArm Co. Ltd.

- Al Mar Products
- Altama Military Boots
- Boots (Jungle)
- B-Square Scope Mounts
- Bianchi Holsters
- Bilsom Ear Muffs
- Bionic Ear
- Blacksmith T. Books
- Blue Book of Gun Values
- Bodyguard Bear/Dog Deterrent
- Break-Free CLP
- Butler Creek Scope Covers & Acc's
- Chapman Screwdriver
- Choate Machine & Tool
- Cocoon Sleeping System
- Collector Grade Publications
- Colt Firearms & Acc's
- Compasses
- DBI Books
- Delta Publications
- EK Knives
- Field Equipment

Born In The
U.S.A.



..... Sold In
Canada

- Gilmore Holster
- Glaser Products
- Hogue Grips
- Kleen-Bore
- Laser Scopes (ALS)
- Life Finder-Heat Sensor
- Mag Lite
- Master Trigger Lock
- Mil-Tech Holsters
- Oakshore Dot Scopes
- Pachmayr
- Paladin Press
- Pathfinder Books
- Police & Security Supplies
- Ramline
- Russian Nite Vision
- S & K Manufacturing
- Safariland Competition Supplies
- Soldier of Fortune
- Spyderco Knives
- Targets
- Topps Clothing
- Trijicon Sights

10769 - 99 Street Edmonton, Alberta, Canada T5H 4H6
Phone: (403) 424-5281 Fax: (403) 424-5306 200+ Page Catalog - \$5.00

POLITICS OVER PRINCIPLE

Continued from page 45

to believe he was guilty.

"I know that during the course of the trial, FBI agents met with the judge and the prosecutor in the judge's chamber and the FBI told the judge that I had made threats against federal agents," Posey said. "A friend of mine, who is also a friend of the judge, told me that Hobbs told him that." Posey said he had never made threats against federal agents, but he did talk publicly about his concerns with BATF actions at Waco, Texas.

In April of 1994, Posey was sentenced to 24 months in prison. His attorney, Doug Jones of Birmingham, advised him against pursuing an appeal. "Our attorney kept telling us that if we fought it [in appeals court] that they were going to beat us into the ground and make it worse for us psychologically," said Posey.

On 13 May 1994, Posey entered prison at the Talladega Prison Camp.

At about the same time he hired a new attorney, Mike Seibert of Huntsville, Alabama. "I finally remembered Mike from seeing him at gun shows," Posey said. "I should have had him all along, but I just didn't think of him at the time."

Posey and Seibert both believe the charges and the prison sentence are retaliation for his contra activities. "When the government spends \$1 million investigating one individual and can't get a conviction, it's an embarrassment," Posey said. "This is definitely retaliation for my actions against the Sandinistas and the liberals in Congress during the Iran-Contra era."

The three other people convicted in the case received much shorter sentences, with one receiving only three years of probation. Ray Black, who testified against Posey, received only six months.

To this day, Posey contends, the government still believes he was using CMA as a money-maker for himself, and that he knows too much about the government's own activities during those years. "I was not doing this as a money-maker for me,"

Posey said. "The feds keep looking for hidden money, but it's not there."

Seibert said the government is concerned that Posey may know details about government involvement in a drug-smuggling operation that was allegedly run out of Arkansas. It was there that planes were loaded with rice to send to the contras. He said Posey was simply caught in the middle of something and didn't realize what was happening. The government, though, doesn't believe that. Seibert filed an appeal in April seeking to overturn Posey's conviction. He hopes to hear something on the appeal by this spring.

Life, Like At A Transfer Station

"Tom's an honest man who never sought to make money from his efforts," Seibert said. "He's an honest man who was connected with dishonest people. The primary reason the government's after him is that he is outspoken." Posey has a lot of time now to think about the things that have happened to him in the last few years. Time passes slowly behind the walls of a federal prison, but it hasn't

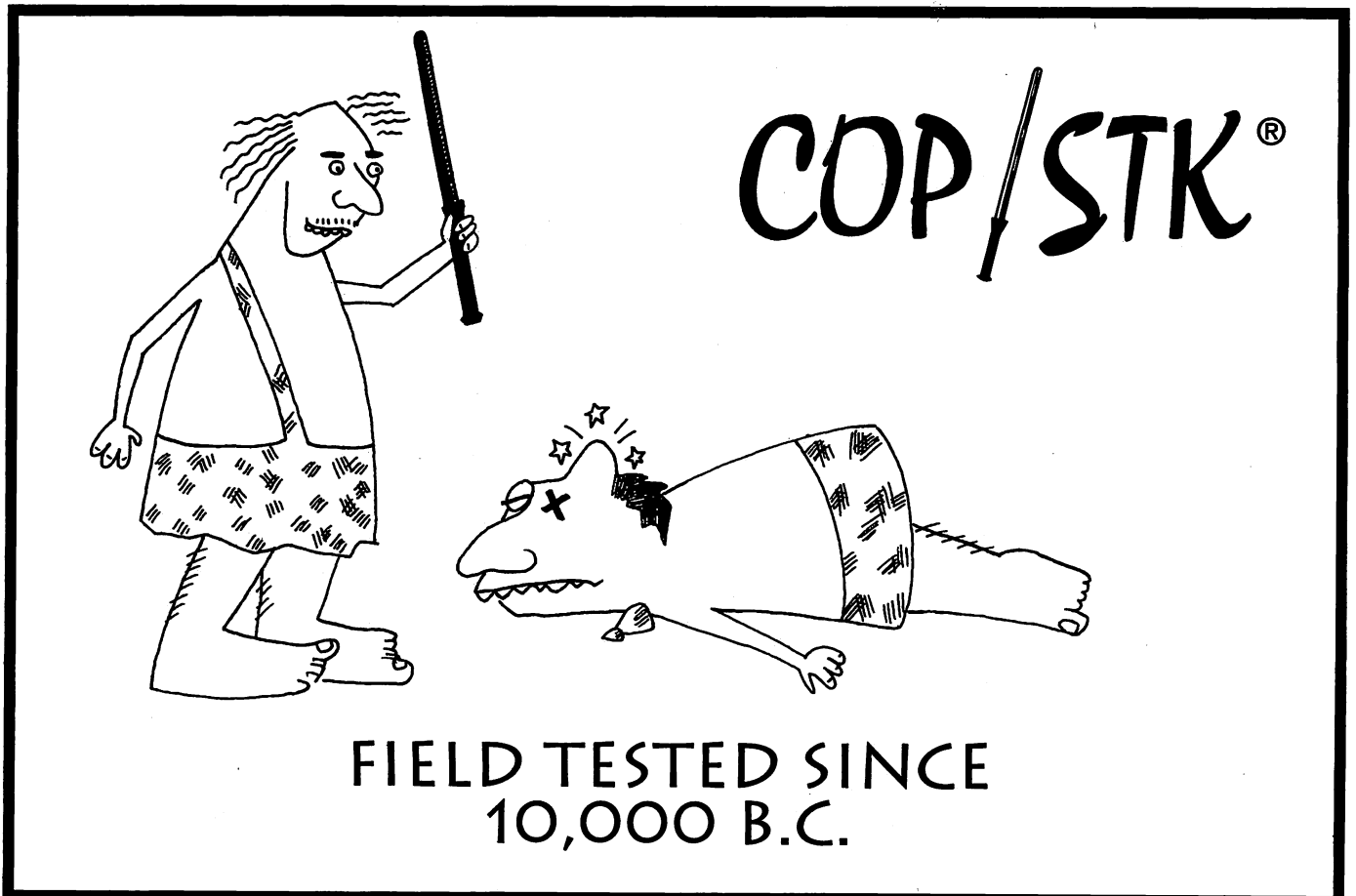

BELTBAG HOLSTER

U.S. MADE. Carry concealed with this low profile BELTBAG HOLSTER. You can carry MACE, STUN GUNS, or a PISTOL in the false back. Simply rip open the hook & loop and snap closure for quick access to the contents.

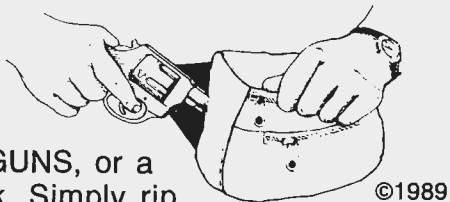

©1989

The BELTBAG HOLSTER is made from black leather or 1000 Denier CORDURA Nylon in 4 sizes. The Nylon bag is available in solid blue or solid black, or two tone using one of 4 trim colors (grey, maroon, turquoise or blue). Left hand or long belt available on request at no extra charge.

- | | | | |
|-----------|--|-----------------|-------------------|
| Style #1- | fits small 22, 25 autos up to AMT back up | Nylon...\$15.00 | Leather...\$35.00 |
| Style #2- | fits 2" S&W J-frame, Walther PPKS, Colt Gov't 380 | Nylon...\$20.00 | Leather...\$45.00 |
| Style #3- | fits Colt OM, Glock 19, S&W 6900, B91.3, 2" S&W K-frame | Nylon...\$25.00 | Leather...\$55.00 |
| Style #4- | fits Colt 1911, Browning HP, Beretta 92, 3" Revolver, most large autos | Nylon...\$30.00 | Leather...\$65.00 |

(\$3.50 S&H) Call or write for FREE catalog

KG PRODUCTS
1740W Churchill Dr.
Oakland, OR 97462



1-800-944-7717

eroded his conviction that what he did to help others was right.

Posey said he is trying to keep a good mental attitude about his experience in prison. "It's been a real education for me," he said. "I'm trying to live it like life at a military transfer station, like I'm waiting to be assigned somewhere. I'm more concerned about what this is doing to my family than anything else."

Patsy Posey said she never believed this could happen. "From the way they've done him, what all I know about it, it makes me very angry," she said. "I didn't think a government would do this to its own people. Maybe they don't like this man or what he stands for, but that's what's made America great. Just because a few people didn't like Tom or what he was doing didn't give them any reason or cause to harass him."

One of Posey's sons, Marty, was in his sophomore year of college planning to major in criminal justice and become a law enforcement officer when his father's troubles changed his mind. "Marty was interviewed by the FBI and he later saw the transcript of that interview," Posey said. "And he saw how things he said were twisted and changed. He wanted to be in law enforcement, but this has left him very bitter."

While Posey believes he will eventually win his appeal, he knows it won't make any difference in his prison sentence. He will be eligible to go to a halfway house for a couple of months beginning in August. After that, he faces home confinement until December, followed by probation for three years. "Even though we'll win, I'm going to have served a year or more in prison by then," he said. "It's a year of my life that they can't replace, and they won't say they're sorry."

For Posey and other ordinary folks the feds go after, the problems are made worse by lack of funds to fight prosecutors who have virtually limitless resources. "I've had to sell the few things I had to pay for my defense," Posey said.

A former newspaper publisher and editor, David McElroy is now an Alabama-based freelance writer.

If you would like to contribute to Posey's appeal, send a check, payable to: Patsy Posey, P.O. Box 3012, Decatur, AL 35602. ✕



Fly High...Fly Proud... FLY WITH THE EAGLES!

No manufacturer offers more proven winners than Eagle Arms.

The Growing EA-15 Family of Competition Rifles Now Includes:



E2 Competition Flattop Models

•E2 "Eagle Spirit" (for IPSC and Action rifle matches)

Flattop upper receiver, aluminum tubular handguard, 16" match grade barrel and muzzle compensator.

•E2 "Action Master" (for IPSC and Action rifle matches)

Flattop upper receiver, aluminum tubular handguard, 20" match grade barrel and muzzle compensator, optional dovetail NM sights.

•E2 "Eagle Eye" (for long range rifle competition)

Flattop upper receiver, 24" free floating stainless heavy match barrel, tubular aluminum handguard.



A2 Style Competition Models

•New! M15A2 HBAR

1-in-9 twist chrome-moly vanadium barrel, hard chrome lined. Full HBAR package includes NM sights and trigger.

•New! M15A2 HBAR-S

As above but with 1-in-9 twist stainless steel barrel.

•A2 "Golden Eagle" HBAR

Simply the finest match grade service rifle in the world. Standard HBAR accessory package and extra-heavy, extra thick match barrel with 1-in-8 twist.

Other EA-15 models also available. Call for specific product descriptions and pricing.



PO Box 457 • Coal Valley, IL 61240 Phone: 309/799-5619

CITIZEN MILITIAS

Continued from page 53

ber of commerce meeting in Reserve, New Mexico. The purpose of the meeting was to discuss the possibility of forming a citizens militia within the county. Concern was voiced by the ranchers over the U.S. Forest Service's possible animal-unit month grazing cuts and a previously passed non-binding county ordinance requiring every household to keep personal firearms and ammunition in the home. The citizens were also questioning why Forest Service rangers, who for years have been unarmed, were now carrying semiautomatic pistols, fully automatic rifles and semiautomatic shotguns.

During the discussion, U.S. Forest Service reserve district ranger, Mike Gardner asked, "What are you guys arming against? A .30-30 won't do any good against U.S. government Bradley Fighting Vehicles and attack helicopters."

Following the remarks by Gardner, two Forest Service agents were caught trespassing on marked land owned by Allan Tackman, a rancher and licensed attorney in Catron. They stated they hadn't seen a 2-by-3-foot "no trespassing" sign at the gate to the Tackman property. When asked by Tackman why they were on his property, the agents laughed and said that they were just scoping it out.

Tackman is filing criminal trespass charges against the agents in magistrate court and possibly a federal civil rights complaint for an unlawful search. According to Tackman, District Attorney Ron Lopez is considering appointing a special prosecutor to try the case against the two agents.

As should be evident by the previous examples, trying to define the current militia movement is impossible. Every week additional militias are forming around the country as citizens respond to needs or perceived threats. While I was working on this article, for example, three northwest Florida counties: Escambia, Santa Rosa and Okaloosa designated all citizens living within their respective counties to consider

K.A.O.S.
KUTLERY



"Knives Are Our Stuff"

FOR MORE INFORMATION

BOX 88 NOXON, MT. 59853

Subscribe to Machine Gun News



"You have a great publication which is a valuable asset to the Class 3 world."

Sincerely,
R.B.,
Wisconsin

Machine Gun News — the indispensable magazine that contains information not found in other firearms publications. **Machine Gun News** keeps you informed about the status of federal firearms laws, rulings and bans, and the effect these laws will have on ownership. Plus, every issue features an arsenal of information in-

cluding in-depth articles and interesting reports on machine guns, suppressors, and semi-autos.

Machine Gun News is a unique firearms magazine that never runs out of ammo.

Special Offer The regular yearly subscription price is \$34.95. But, for a limited time, you can have a full year's subscription (12 issues) for only \$29.95.

Yes! Start my subscription to Machine Gun News. I'll receive 12 information-packed issues for just \$29.95! (Offer good in U.S.A. only. Foreign subscribers send for rates.)

M/C, Visa, AmEx #

_____ Exp. _____

Check/Money order enclosed

To ensure your privacy Machine Gun News is mailed with a protective cover.

Watch for your first issue in 4-6 weeks!

name _____

address _____

city _____ state _____ zip _____

Send to: Machine Gun News
P.O. Box 459, Dept SF
Lake Hamilton, AR 71951

Or call: (501) 525-7514
Fax order line: FAX5015257519



themselves members of their county's militia.

With the advent of the fax machine and 24-hour news services, it is easy to disguise a small group as a large movement. Yet all evidence indicates that the militia movement is a real response to threats of oppression. In 1994 America resorted to the ballot box for change. Hopefully the cartridge box will not be necessary.

For information on Texas Constitutional Militia, contact Steve Brown, 7327 Autumn Park, San Antonio, TX 78249; phone: 210-694-4561.

For information on the Texas Light Infantry, contact Neil Watt, regimental commander, at 512-461-9836.

For information on USSF/NM, contact Leon E. Koon, General of the United States Field Forces/National Militia, Field Headquarters, P.O. Box 432, Camp Bradley M.B., FL 32066-0432; phone: 904-294-3015.

Mike Williams is a veteran SOF correspondent who has covered conflicts from Rhodesia to Bosnia and currently resides in Texas. ✕

MILITARY OPERATIONS

Continued from page 60

bile and prepared for commitment ... [and] can stay close to forward units." The effectiveness and disadvantages of armor are covered. With or without armor, it was the lack of an effective reserve that crippled operations in Somalia.

Defense of urban terrain requires special considerations — all of which are cited and discussed. The motives to defend a built-up area are many: Is it strategically important? Does the area cover an avenue of approach? Can forces be concentrated and well concealed? The motives against defending in an urban area are also explained: Location does not support an overall defensive plan; terrain allows enemy to bypass the area; structures do not support defensive ops; and built-up areas can be dominated by nearby terrain. The significance of these considerations go far in explaining successes and failures in Bosnia and Chechnya.

The military success of any army is

decided at the squad level. MOUT operations require specific, strenuous squad-level tasks: moving and firing, entering and clearing buildings, selecting and employing firing positions. These tasks are more important and exhausting in a MOUT environment. This FM details these individually and collectively, building fire-team tactics up to squad level. Any organization developing a training plan to prepare for MOUT ops will want to consult this manual.

The most useful section covers the effectiveness of weapons. If you are looking for a chart detailing the number of rounds required from an M60 to shoot a 10-inch hole through concrete block with a single brick veneer, look no further. In fact, there is a gold mine of charts depicting penetration capabilities of rifles, machine guns, grenade launchers, crew-served weapons and anything else you are likely to find in a motor pool, arms room or ammo storage point. Hit probabilities, back-blast effects and a weapon's dead space are all covered. This is the kind of no-nonsense factual data often overlooked during peacetime training.

This book will find many users.

JR Customs Co.



Automatic Weapons Co.
Antares Technologies, Inc.

HAVE JOINED FORCES TO BETTER SERVE YOU AS . . .



GEMINI TECHNOLOGIES, INC.

DBA - GEMTECH

Doc Dater of the ORIGINAL A.W.C. and Jim Ryan & Mark Weiss of J.R.C. are pleased to announce our consortium as GEMTECH to bring you the finest sound suppressors on the market today.

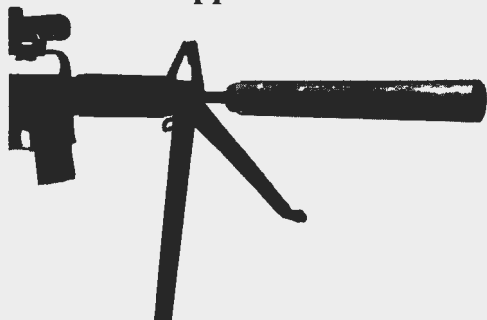

P.O. Box 3538, Boise, ID. 83703

Dater - (208) 939-7222

Ryan & Weiss - (509) 697-3315

FAX - (509) 452-3398

Catalog available upon request. Individuals send \$3.00. Dealers send FFL & EIN

Military leaders need it to prepare for inevitable battles, and revisit lessons learned in past conflicts. Police departments need it — if intent on paramilitary operations, such activities are much safer for everyone involved if properly conducted. The press needs it to better understand why things happen the way they do. Militias will be attracted to better conduct training and understand their perceived enemy. It also gives you an idea how difficult it is to Bradley-proof your home.

It's odd that the military is keeping so close-hold a manual for which there appears to be such a vast audience. Fortunately, Paladin Press (Dept. SOF, P.O. Box 1370, Boulder, CO 80306; phone: 800-392-2400) has come to the aid of MOUT-minded Americans. They have procured a copy of *FM90-10-1* and are reprinting it for the civilian market. ✕

CHECHNYA

Continued from page 35

lines and cutting power that keep us busy," Yuri explained. "We send teams

out on regular patrols, link up with other Spetsnaz groups in the area and maintain security. We also do other things that I can't discuss." Those other things, according to one of the less security minded in the squad, involved keeping a close watch on suspected supporters of Dudayev, monitoring the stone-age telephone exchange that serves the area and making house calls on "people who wish to hurt us."

T-72 Hunt

The next day Aleksy took me into their barracks area to share his lunch, but no sooner did we sit down than traffic on his walkie-talkie picked up. Then a fully sandbagged diesel locomotive pushing four dirt-piled flat cars, one with a BMP-2 mounted on it, came rolling through the rail station. Following closely at about 200 meters up were three Mi-24 attack helicopters and an Mi-8 escort.

No one looked up as the four choppers buzzed over our heads. With near-non-stop sorties of Su-25s, Su-27s and MiG-29s buzzing over Grozny like flies around a bleeding wound, the air activity is so regular it has stopped catching anyone's attention. But some-

times when you don't look for the action, the action finds you — soon one of the helicopters spotted a lone T-72 main battle tank prowling around the edge of a lightly wooded area about 5 kilometers south of Ishcherskaya and reported it to Yuri.

One thing that will sober up even the drunkest soldier or make the most beautiful woman seem suddenly irrelevant, is a report that a T-72 is on the prowl in your neighborhood. Yuri stopped eating and quickly mounted a 90mm grenade launcher below the barrel of a colleague's black electric-taped 5.45x39mm AKS-74, and gave one of the other soldiers his 9x18mm Stechkin machine pistol.

In less than a minute Aleksy and Yuri's squad was out the door and running through the muddy garden separating them from the road. Yuri and two others were first to cross the street and secured an exit for the rest of the squad. I crouched behind Yuri as "Arnold" — the biggest guy in the outfit — set up his PKM machine gun to lay a fire line down the main street.

The distinctive sound of steel tread on asphalt became louder, and the entire team, now split into two groups

NIC, Inc. Law Enforcement Supply

MC/Visa
Call 24 Hours!

1-318-688-1365

PHOTO CARD KITS

CONCEALED WEAPONS

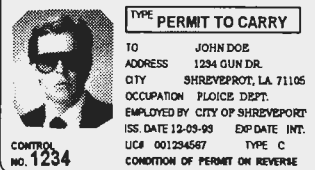

Only \$4.95 Our Professional quality, laminated photo cards will amaze your associates! We provide the cards, plastic laminate and easy instructions. You supply only a photo. Your photo Card can be finished in the privacy of your home. The result is a distinctive, professional system! The highest quality cards in the U.S. Lost your original card? Replace it now!

Select From These Kits:

- | | |
|----------------------------|--------------------------|
| C04 Bounty Hunter | C06 Mercenary |
| C13 Special Investigator | C41 Intelligence Officer |
| C45 MAC-V (CIA) #1 | C212 Official Press |
| C60 MAC-V (CIA) #2 | C46 Special Forces |
| C14 OCB | C47 Seal Team |
| C52 Air America Pilot | C18 Pilot |
| C01 Press Card | C03 Security |
| C50 Phoenix Program | C17 Int'l Drivers Permit |
| C49 Delta Force | C11 Private Invest'r |
| C25 Parachutist, Certified | C02 Bodyguard |
| C10 Concealed Weapon | C12 Security Consultant |
| C07 Weapons Specialist | C51 Special Operations |

Any
Three
Only **\$11.95**

Any
Six
Only **\$19.95**

The Poor Man's Jame's Bond

The most famous book ever written! It is a kind of Do-it-yourself mayhem. Sections include the Still, Fougasse, how to beat the metal detector, evading pursuit, blowing up a car, napalm, poisons and over fifty other fascinating items. 477pg. diagrams and illus. 8 1/2"x 11".

Order #B450 \$16.00

The Poor Man's JAMES BOND



.22 L. R. Ammo FOR SILENCED WEAPONS Subsonic Hollowpoint Ammo

No Muzzle Crack! Less Noise for any .22! Loads flawlessly in all guns! Manufactured in Germany. Used by Israeli Mossad and numerous Elite Paramilitary Forces! **Box of 50, \$6.95; + 3.50 S&H 3 Boxes for \$18.95; + 5.00 S&H**

NIC Law Enforcement Supply 500 Flournoy Lucas-Bldg. #3-135 Shreveport, La 71135

Order #318-688-1365 Fax #318-688-1367

Name _____
Address _____
City/St/Zip _____
Phone () _____

British Honduras Diplomatic Passports

Only 257 available. They have all the necessary immigration, entry and exit stamps and do not expire until Dec. 31, 2004. These passport could save your life as they are bland and can be filled out with a typewriter at the owners convenience.

Order # DP1 \$87.00

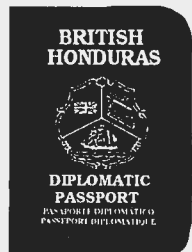

CIA BADGE

3" Brass badge with gold finish & multi-color enamel design.
#M142 \$29.95

•Large selection of CIA items available!

Card # _____ Exp. _____
Visa M/C M/O Check
Add \$4.00 S&H / Except for Ammo!
Free Catalog with order!
Or for our 100pg. full color catalog send \$4.00 or call 1-900-226-2444 for Rush shipment.

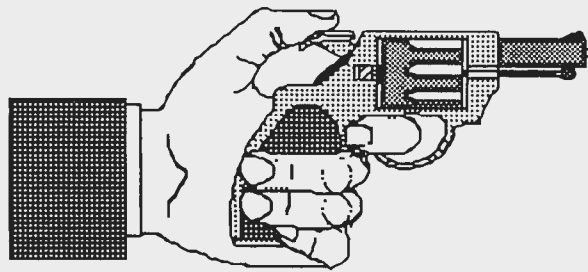

**Bang
Bang
Bang
Bang**



HOLLYWOOD

10642 Armintha Street
Sun Valley, CA. 91352
(818) 842-8376
Joe & Margaret Mueller

HOLLYWOOD

**ENGINEERING
DIES "R" US**

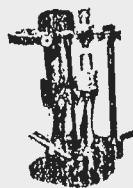

and holding opposing sides of the road, moved closer to the sound. An old woman, hearing the commotion outside her house, opened her front gate and got the surprise of her life when Aleksi used his forearm to send her sprawling back into her yard screaming and holding her face.

An RPG team came up behind us as the first intersection was secured. A spotting team shot off a lock to the water tower to get a better idea of the tank's whereabouts. Because it was wet, the tank wasn't throwing up a lot of dust. But, because the clouds were low, the sound of the tank carried, making it seem much closer than it actually was.

First faintly, then with a deadly, high-pitched roar, one of the Mi-24s came back to hunt down the tank. Yuri yelled at two of the local militia attached to his squad to fan out to the left along the railroad tracks and not to engage the tank if it came, but instead call for help.

My heart practically ran over my tonsils as it jumped into my mouth when the tank appeared about a kilometer down the end of the road with its main gun pointing straight at my position. Aleksi, Yuri and the others started burying themselves a centimeter at a time into the hardened snow. Out of the corner of my eye I watched the RPG team slowly begin moving to outflank the T-72.

Then, without warning, the tank moved laterally, swinging its turret around and, without firing a shot, retrograded out of Dodge.

Bandits & Moscow Boys

"He won't come into a town without support," Aleksi said. "And right now, he's got no support and probably knows we're here waiting for him. No need to risk losing a tank for us." Everyone stood up and breathed a sigh of relief as the metal monster moved on. Aleksi, however, still wanted to monitor its whereabouts.

"Where's that fucking helicopter?" he yelled into his walkie-talkie. Nothing but some unintelligible Russian military speak (at least to me) came back. We began walking slowly back to the railroad workers dorm for some Chechen cognac, grainy bread and German chocolate.

"Did you see Valery's face when that tank turned toward us," joked



**SOF THREE-GUN
International Tactical Shooting Match**



SEPTEMBER 26-30, 1995 DESERT SPORTSMAN'S RANGE LAS VEGAS, NEVADA

Held in conjunction with the 1995 SOF CONVENTION & EXPO, the Three-Gun International Shooting Match is patterned after military and police courses and is designed to test practical shooting skills with rifle, pistol and shotgun. Each shooter is required to engage targets before, during and after negotiating man-made obstacles or natural terrain features. Course scenarios are those that could be encountered during a confrontation with an armed adversary. Our objective is to determine the world's best three-gun combat shooters and best four-man combat shooting teams. Individual and team trophies, cash and prizes total over \$60,000.

To be a part of the world's premier Three-Gun Match and to receive further information, please send a business size self-addressed, stamped envelope to:

Michael Horne 408 E. Harding Bakersfield, CA 93308

SURVEILLANCE & SECURITY

FM TRANSMITTERS MINI (KITS)

- 3-VOLT FM XMTR, up to 300 ft. indoors, 1500 ft. outdoors
- PHONE XMTR, range to 500 ft., uses phone-line power
- Sound-Activated XMTR, range to 500 ft.
- 2-STAGE XMTR, 9-Volt, very powerful

All above require simple soldering at 2 to 4 places.
\$29.95**

TELE CALL FORWARDER. Transfers incoming calls. \$99.00*

CALLER ID. Registers incoming number. \$99.00*

TEL REGISTER WITH PRINTER. Records dialed number, duration, and prints record. \$169.00*

TEL REGISTER W/O PRINTER. Records dialed number & time. 16-digit display. \$99.00*

12-HOUR LONG-PLAY RECORDER. Modified Panasonic. Records 6 hrs. on each side of 120 tape (supplied). Compatible with VOX and Tel Rec Adapter. \$119.00*

VOX VOICE-ACTIVATED SWITCH. Makes recorder self-activating with voices or other sounds. \$28.50**

TELE RECORDING ADAPTER. Records incoming and outgoing calls. \$28.50*

TELEPHONE SCRAMBLERS. Over 4,000 separate codes. \$199.00*

VOICE CHANGER. Changes man's voice to lady's and vice versa. \$49.00**

For Shipping & Handling add *\$5.00 and **\$2.00 per item. Colo. residents add sales tax. Mail Order, VISA, M/C, COD's o.k. Inquire for dealer prices. Free catalog.

MUCH, MUCH MORE — OUR 25TH YEAR!

TOLL FREE 1-800-926-2488

A.M.C. SALES, INC.

193 Vaquero Dr., Boulder, CO 80303
Tel: (303) 499-5405, Fax: (303) 494-4924
Mon.-Fri. 8 a.m.-5 p.m. Mtn. Time

BODY ARMOR THAT STOPS .44 MAGNUMS

and weighs only 3 lbs.!



SOFT, COMFORTABLE, CONCEALABLE BODY ARMOR MADE WITH 18 LAYERS OF DUPONT KEVLAR.

MED: \$170 LRG: \$205 XL: \$275 XXL: \$315
Adjustable ballistic panel carriers available in white and navy.

5 YEAR WARRANTY ON BALLISTICS

Prepaid orders add \$5. \$10 charge for COD's. One week shipping for stock sizes. State height and weight when ordering. Money orders and certified accepted. COD's cash only. Air Shipping Extra.

MICHIGAN BODY ARMOR
P.O. BOX 251423, WEST BLOOMFIELD, MI 48325
TEL/FAX 810-788-2234

Mikhail, one of the local militiamen. "He turned white." Everyone in the room broke out laughing.

Cognac began flowing and soon everyone was ready to exchange souvenirs. I gave all of them patches from the U.N. volunteer firefighting force in Sarajevo, and in return I got a box of 9x18mm ammo and a box of Russian MREs. Talk then turned to who the best marksman was in the group. Somehow something I said was interpreted as a challenge of shooting skills. Out of the blue, an SVD Dragunov sniper rifle was produced, some empty vodka and Pepsi bottles lined up, and without any announcement it was the United States (represented by me) against a Russian Spetsnaz squad (all of them). It didn't take long until it was agreed that this boy from Jersey City, New Jersey, needed a refresher course at his local range.

We all later sat down, and in between cleaning weapons and washing mud off of boots, talked about the war. "I hear those boys in Grozny are having a hard time," Mikhail said. Alekski laughed, and said that they must be amateurs. "Let those bandits fight with a real soldier," he said, patting his chest. "Let them fight with this Moscow boy and that will be it."

The next morning in Grozny, I got a chance to see what Alekski meant when he said to let a Moscow boy do the fighting and see what happens. The Chechen capital looked like the first 20 minutes of *The Terminator*; compared to it, Sarajevo seemed like a four-star resort. Destroyed Russian armor lay tangled up with broken tree branches and unexploded shells, and the sound of propeller-driven Russian air force reconnaissance planes was always in the background, along with the barking of artillery.

That day I made it to within 4 kilometers of the besieged presidency. But local militia had blocked off many of the streets, and without Russian army escort (i.e. armored vehicles) further travel was a serious no-no.

Mark H. Milstein is SOF's European correspondent currently based in Budapest, Hungary. He's in Grozny as we go to press. Watch for the conclusion to his report on the Chechen war next month. ✕

Let Your Feelings Be Known!

D.O.A.

(De•O•A) : Failed to obtain his wellness potential.

4002-Dead Is Dead.D.O.A. Black T-Shirt M,L,XL \$ 17.95 PPD 4015 D.O.A Black/Sweatshirt L,XL \$ 27.95 PPD.

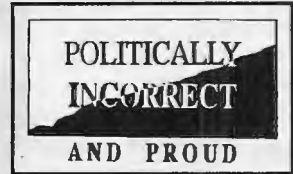

4006 You Too Can Be Politically Incorrect White / T-Shirt M,L,XL \$ 17.95 PPD. 4017-Politically Incorrect White/Sweatshirt L,XL \$ 27.95 PPD.

ORDER NOW !

WILD THINGS

529 S. 7th St #698 Dept. S Minneapolis, MN. 55415

Visa/MC. Check or Money Orders

COLLECTORS RUSSIAN EDITION OF SOLDIER OF FORTUNE

* Each issue is numbered and includes a notarized statement of authenticity.



* Each certificate is signed by Robert K. Brown.

* Less than 600 available.

* Only \$20 per copy!

Payment enclosed (U.S. funds only)

MC Visa Exp. Date _____

Card # _____

Signature _____

Name _____

Address _____

City _____

State _____ Zip _____

mail to: SOF Russian Edition

P.O. Box 693 Boulder CO 80308

**THE
FIRST
TEAM**



**Safari
Arms,
INCORPORATED**

620 - 624 OLD PACIFIC HWY SE • OLYMPIA, WA 98513
TELEPHONE (206) 459-7940 • FAX (206) 491-3447

Carry-Comp .45s now available from **Safari Arms** — with the Wil Schueman-designed hybrid compensator system. Adds no length or significant weight to the pistol, yet drastically reduces recoil.

Right: Matchmaster and Enforcer Carry-Comps



ENFORCER

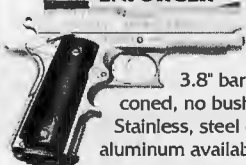

3.8" barrel, coned, no bushing. Stainless, steel or aluminum available.

MATCHMASTER

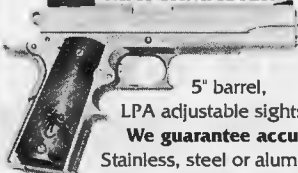

5" barrel, LPA adjustable sights. **We guarantee accuracy.** Stainless, steel or aluminum.

CREST RENEGADE

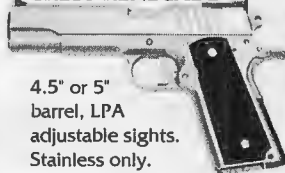

4.5" or 5" barrel, LPA adjustable sights. Stainless only.

At last! A custom quality left-handed .45 ACP at a reasonable price for **LEFT-HANDED** shooters. Tired of catching hot brass in your teeth? Try the **RENEGADE!**

**Compliments of
Mikhail Gorbachev...**



**Warsaw Pact Military Binoculars
Never Before Available in the West.**

EDF 7X40 - (manufactured by Carl Zeiss-Jena)

Used by East German border guards along the Berlin Wall, these are thought to be the finest roof prism binoculars ever made. Current issue throughout Eastern Bloc; never before offered to civilian market. Astounding optical clarity and brightness. Includes rangefinder reticle with tritium illuminator, infrared night vision filter, rubber armor, complete weatherproofing. Built to extremely rigorous military specs. Each piece new in the box with English instructions and individual serial number. Money back guarantee if not satisfied.

Exceptional price of \$499 includes a lifetime warranty.

CA residents add 7.75% sales tax. Quantities are extremely limited, however; order now to ensure delivery. Sorry - no more than two pieces per customer.

Call **SCM Corporation 1-800-225-9407**

BULLETIN BOARD

Continued from page 9

and harassment in an incident last May in a Sedalia, Colorado, bar and grill. Fellow agents testified that four of them went to the bar for a "working lunch" — billing the government for their time — that entailed 11 pitchers of beer and three rounds of booze. When the sots were cut off by the barmaid, Dietze flashed his badge and threatened to close the restaurant down "in five hours." When the owner asked Dietze what badge he was flashing, Dietze poked him in the chest and said, "I could kill you and there is nothing you could do about it," and that he was going to bury his badge in his forehead.

After the drunken pack of civil servants split, leaving live ammo spilled around, the owner called the sheriff, and deputies stopped their car near the restaurant, but let them go without a roadside sobriety test when their group leader told deputies the gang was "conducting an undercover operation."

Well, Dietze ol' buddy, sure sorry about the conviction, but cheer up: Since you're a federal officer, it'll probably be worth a fat promotion.

TIANANMEN SPARES

Shades of Soylent Green: an exiled former Chinese police official claims that commerce in human organs salvaged from the estimated 10,000 prisoners executed in China each year has become a multi-million dollar business. According to a BBC special report, around 2,000 kidney transplants are performed every year with foreign patients paying up to \$32,000 for an operation (parts and labor).

According to the BBC report, the prisoner's family would be placed under house arrest while the executions were taking place, and fully equipped ambulances were at execution sites to quickly remove the organs from prisoners. One doctor told of removing both kidneys from a live inmate

(which is fatal within 24 hours) while he was a medical student: "After I had sewn him up, the organs were taken away in a helicopter."

While arranging a transplant for a fictitious recipient, the BBC crew was told by a Chinese doctor that the hospital did not accept credit cards and wanted cash — preferably dollars. Taiwan and Hong Kong are enacting legislation to stop any trade in prisoner parts through their ports.

EVERY OTHER VOTER A GUN OWNER

Ms. Kellyanne Fitzpatrick, senior account executive at Luntz Research Companies, noted after last November's election, "Gun owner influence and grass roots helped pull levers in every voting booth in America." Nearly one-half the voters polled had a favorable view of the NRA, with some 25% feeling "strongly favorable." This, of course, never hit the liberal "mainstream" media, who bends every effort to vilify the NRA and wouldn't want the public to know the media distortions are falling on deaf ears. Noted Fitzpatrick, "About half of the voters in line at the polls were gun owners tired of politicians who didn't listen and non gun owners opposed to the Clinton Crime bill." When the giants in Washington rail about the fact there are gazillions of guns in America, it never seems to sink in that they belong to the body politic, i.e. voters who will throw out any bum who wants to take these guns away.

"With 49% of actual voters owning at least one gun, the evidence is overwhelming that gun owners — and other Clinton Crime bill opponents — were effectively stirred into a stormfront that led the Republicans to power in Washington," Fitzpatrick said.

CHINESE SWAT TEAMS

The Huansha restaurant in Guangshui, China, was fined 15,000 yuan (\$1,762) when fly police found dozens of the winged insects hovering near live fowl kept in cages by the door. Fines can be up to \$235 per fly. Well, whatever works for them. ✕

Using G-Jo - First-Aid of the Samurai - You FEAR NO PAIN OR INJURY!

It's true! As a Master of G-Jo Acupressure, you can "erase" pain (and most other common ailments) in seconds ... using nothing but the touch of your finger! G-Jo is based on a network of secret pressure points (many of them used in the martial arts). When an injury occurs, reach for the right G-Jo point ... "trigger" it in the special way...and sigh in relief! Be up and ready for action in moments -- or help your loved ones, friends or students -- using this remarkable technique. G-Jo is so foolproof it works for skeptics as well as "believers." G-Jo even halts serious bleeding. This life-saving skill is *vital* for those in the martial arts... the healing arts... survivalists and outdoorsmen -- or anyone who ever finds himself far from doctors, medical help or hospitals.



G-Jo is safe for all ages... natural... effective in healing hundreds of injuries and ailments ... and it works instantly! Not only for treating serious injuries, G-Jo relieves headaches... backpain... indigestion, and other common ailments in seconds. Proven to millions on major talk shows. So effective, G-Jo can even become your total health-care program! Yet this age-old technique is so easy, you can actually become a certified *Master of G-Jo Acupressure* in as little as one weekend of study! We offer the only home-study acupressure certification program available. Send for your **FREE** report today. The G-Jo Institute, Dept 111, Box 8060, Hollywood, FL 33084 "Teaching G-Jo Acupressure Since 1976"

New assault rifle case

from



AK47/MAK90 and
Colt AR15 Lightweight

Shooting Systems sets the world standard for assault rifle cases. Padded with thick foam for maximum protection yet light weight. Full-length zipper with padded internal flap for additional protection. On the exterior is a set of easy access magazine pockets, plus a large accessory pocket. Wide handles and shoulder strap. Available in black or Woodland camouflage. Length 36" \$75.50

**SHOOTING
SYSTEMS** GROUP
INC.

Formerly known as Assault Systems

1075 Headquarters Park, Dept SF
Fenton, MO 63026-2478
Toll-Free 1-800-325-3049

Questions? Call our toll-free number.
We've got the answers—our complete
24-page, full line catalog, brochures,
brand new products.

WARNING! Don't Get Fooled By Frauds.
Other companies claiming to have similar, better or all in one products can't compare because of mg dosage ask compare and beware

STEROIDS

Alternatives

ALL PRODUCTS 100% NATURAL NO HARMFUL SIDE EFFECTS

- 1. DIBENCOZIDE 10mg** is the most powerful steroid replacement on the market & 100% legal. World records have been set while using this product! 2 month cycle \$22.50
- 2. BORON 10mg** naturally enhances testosterone levels so you can build muscle without the harmful side effect of illegal steroids. 3 months cycle \$15.95
- 3. GROWTH HORMONE RELEASER G.H.R.X.** Releases growth hormone in abundance like no other. Works great with Boron. 60 Tabs. \$ 21.00
- 4. LEGAL STEROL COMPLEX** enhances growth. Allows body to stay pumped longer. Releases growth hormone and strips away fat! 60 tabs \$ 19.95

LIFETIME 100% MONEY BACK GUARANTEE

Buy products 1, 2 & 3 and get # 4 FREE. This will enable you to have the most powerful natural anabolic stack on the market.

C.O.D. ORDER NOW! C.O.D. WELCOME C.O.D.

1-800-398-6946 ask for ext 120
send check or M.O. (add \$4.00 for shipping)



S&K Labs
2637 E. Atlantic Blvd., Suite 101
Pompano Beach, FL 33062



- _____ Dibencozide 10 mg (2 month cycle \$ 22.50)
 - _____ Boron 10 mg (3 month cycle \$ 15.95)
 - _____ Growth Hormone Releaser (60 Tabs \$ 21.00)
 - _____ Legal Sterol Complex (60 Tabs \$ 19.95)
- _____ Add \$ 10.00 for priority mail

Name: _____
Address: _____
City, State, Zip: _____
Phone () _____

CAREER-LEVEL HOME STUDY COURSE:

Be a paralegal!



Train now for a great future. Work closely with lawyers in one of today's fastest growing, most exciting fields. Foundation and Advanced Courses. Free literature: send or call 24 hours a day.
800-223-4542

Name _____ Age _____
Address _____ Phone () _____
City _____ State _____ Zip _____

School of Paralegal Studies, Dept. LLE171
PCDI, 6065 Roswell Rd. Atlanta, Georgia 30328

LILE HANDMADE KNIVES

"ARKANSAS KNIFESMITH"
Excellence since 1970

Designer & Maker
FIRST BLOOD & RAMBO

Deathwind
Hunter or Military



Deathwind
Hunter or Boot

Visa & Mastercard - also Lay-away
2721 S. Arkansas Avenue
Russellville, AR 72801

501-968-2011 Fax 501-968-4640

PRIVACY ?

Avoid BIG BROTHER.
Best techniques for creating COMPLETE PRIVACY!

- Avoid Surveillance, Eavesdropping
 - Become "Invisible" to Investigators
 - Stop Generating Financial Records
 - Communications Privacy . . Phone, Mail
 - How to Stay Out of Government Files
 - Begin Eliminating Negative Records
 - How to Create Helpful New Records
 - Generating Quick Cash Income
 - Hiding Your Assets ■ Privacy Afloat
 - Banking Alternatives ■ "Low Profile"
 - Privacy from Taxes ■ Nomadic Living
 - Multiple Addresses
 - Hideouts, Deep Cover
 - How to "Disappear"
- ALL THE PRIVACY YOU WANT — and MORE!**
Visa/MC: 800-338-8484



ONLY \$18.95

EDEN PRESS
11623 Slater "C", Box 8410-AP Fountain Valley, CA 92728

Your Regular P&H, \$3.00 (Please add Choice FIRST CLASS, \$6.00 to order.)
(California residents please add 7.75% sales tax.)
 Send latest Book Catalog — FREE.

Name _____
Address _____
City _____
State _____ Zip _____

BULLETPROOF VEST

Will stop the .357 Magnum, 9mm and 00 Buck. Meets and exceeds "Threat Level II-A" tested in accordance with the NILECJ-STD-0101.01. Weighs 2 3/4 lbs. Fits easily under T-shirt.



Front & Back Protector \$220
Detachable Side Panels \$45
Chest Trauma Plate \$35

Officially tested by the U.S. Government Edgewood Arsenal at the Aberdeen Proving Grounds under the U.S. Department of Justice Standards. State height, chest and waist measurements.

MATTHEWS POLICE SUPPLY CO.

(a division of David Matthews, Inc.)
P.O. Box 1754 Dept. 5F
Mathews, N.C. 28105
Ph. (704) 847-8793 FAX: (704) 847-4447

THE HOUND DOG

Sniffs Out Hidden Transmitters

Throughout the world today, corporations, professional men, and businessmen are spending millions annually to insure privacy in their offices and homes where important plans and policy making decisions are discussed and formulated. The "HOUND DOG" is a wise investment for anyone who has reason to believe that an eavesdropping device is now hidden, or may be hidden in the future, in either home or office. No radio transmitter, no matter how well it may have been hidden, can escape detection by the "HOUND DOG".

The "HOUND DOG" is an advanced electronic instrument designed for the sole purpose of locating hidden transmitters. An average size office or room can be thoroughly searched in only a matter of minutes. The "HOUND DOG" sniffs out any transmitters hidden in pictures, walls, desks, chairs, etc., regardless of their operating frequency.

The "HOUND DOG" is simple to use. Single knob adjustment calibrates the meter and any transmitter signal received is indicated by the meter movement. By simply sweeping the probe past walls, chairs, pictures, desks, etc. the presence of any transmitter will cause a rise in the meter reading. The meter reading will continue to rise as the probe approaches the transmitter.

We believe you will find the "HOUND DOG" outperforms most other units selling for several times the price. This item has been built since 1962. Each one is backed by a 3-year warranty by us.

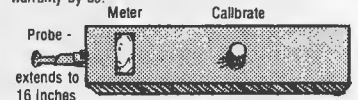

Meter Calibrate
Probe - extends to 16 inches
\$195.00
SIZE: 1.6 x 2.4 x 8.2 INCHES
USES A COMMON RADIO BATTERY



Super Powerful FM TRANSMITTER

Many times more powerful than other transmitters. Transmits up to 1/4 mile to any FM radio — Easy to Assemble Kit — up to 8V battery (not incl.)

\$19.95

Call 407-725-1000 or send \$195.00 plus \$5.00 shipping for Hound Dog and \$18.95 and \$1.00 shipping for FM Transmitter to USI Corp. P.O. Box SF-2052, Melbourne, FL 32902. COD's OK. For a catalog of transmitters, voice scramblers & other specialty items enclose \$2.00 to USI Corp.

See our catalog on color video



Cross w/ chain \$20.00
War Order Badge \$24.00
Olympics w/ chain \$22.00

These are full size. Not miniatures. Made from originals. We have most complete stock of WWII German badges-caps, etc. in U.S.



WWI U.S. CAP
U.S. Officer's Cap (new from original U.S. maker). Tan with brown leather visor, chin strap and U.S. Eagle pin. State size S, M or L. \$89.00. Have few Olive Drab, Wool \$94.00



GENERAL'S CAP
State S, M or L Size=\$110.00. Shoulder Boards, Set=\$31.00. Collar Tabs, Set=\$18.00. Complete, Knights Cross=\$21.00. The Complete Set. IN STOCK. ALL 4=\$149.00



AFRIKA-KORP. CAP & GOGGLES
German 1942 Mfg. ORIGINAL sand & dust goggles. Still in their pocket pouch. Tan. Otc. caps=New REPLICA. State S, M or L size, Both Only \$39.00



U-BOAT CAPTAIN'S CAP
White top Gold insignia and visor braid. Leather chin strap. State size wanted \$120.00 Knights Cross with ribbon and oak leaf with swords \$21.00



S.S. OFFICER'S BLACK VISOR CAP
State S, M or L \$84.00 We pay postage.

For the back of your jacket...Flying Tigers BloodChit Patch 7" X 11" good reproduction=\$25.00

Video
Our catalog on VHS video only \$20.00 postpaid free w/ \$25.00+ order.

W.W.#2 Ltd. Box 2063-F, St. Louis, MO. 63158

WE OFFER THE LARGEST SELECTION OF BDU'S OF ANYONE!

Starting at

\$25.95 **\$33.95** **\$35.95**

XS-XL XXL XXXL

★★★★★

M65 FIELD JACKETS
Woodland, Olive Drab, Tiger Stripe,
Black, Navy, Khaki. Add \$4.00 for XX **\$59.95**

PULLOVER PARKA
Woodland, Olive Drab, Tiger Stripe,
Black, Navy, Khaki. Add \$4.00 for XX **\$44.95**

ALPHA MA-1
Sage or Black or Navy **\$56.95**

ALPHA CWU-45P
Sage or Black **\$78.95**

**COOPER USAF A-2
LEATHER JACKETS**
36 - 46 Reg. **\$242.95**

G. I. ALICE PACK
Olive Med. **\$58.95**
Large **\$62.95**

Prices may vary depending on sizes. Please call for
additional prices and items as well as a 1994 Catalog.
Mail proper amount plus 6.75 (double for Canada),
(TN residents add 8.25% sales tax)
for shipping and handling to:

GREENE MILITARY
7215 Kingston Pike, Dept., SF, Knoxville, TN 37919
Order Toll Free 1-800-521-7977 In TN (615) 588-5945
Satisfaction Guaranteed or Your Money Back

WE SLASH THE COST OF QUALITY CUTLERY SAVE UP TO 50% ON TOP NAME BRANDS!

**Call now for your FREE*
56 page color catalog!**
(*Outside U.S. \$5)
Satisfaction Guaranteed
Friendly Service
Fast Delivery

Buck • Swiss Army • BK&T
Leatherman • Al Mar • SOG
Blackjack • Benchmade • EK
Spyderco • Gerber • Boker
Henckels • Kyocera • Aitor
Knives • Swords • Tools
and much more!

Cutlery Shoppe™

Dept. SF, 5461 Kendall St., Boise, Idaho 83706-1248
800/231-1272 • Fax 208/376-7608

Target to Adventure!

U.S. Cavalry has everything you'll need for your adventurous lifestyle! Over 120 full-color pages loaded with shooting accessories, knives, hi-tech optics, camping and survival gear, GPS's, official and tactical uniforms, communication equipment, flashlights, boots, military memorabilia, personal protection devices, target practice aids and much more. **Guaranteed 100% satisfaction!** For a free full-color catalog (\$4 value), send your name and address to:

U.S. CAVALRY

Dept. SF 2855 Centennial Ave.
Radcliff, KY 40160-9000

GUN PARTS CORPORATION

SUCCESSORS TO NUMRICH ARMS

THE WORLD'S LARGEST GUN PARTS SUPPLIERS

NEW FOR 1995 #19 CATALOG

Featuring an inventory of over **450 million** gun parts we have for sale. A 680+ page catalog with exploded drawings that are invaluable to the gunsmith or hobbyist. **Commercial, military, antique and foreign** gun parts (many exclusively available from us) are listed and priced along with accessories, surplus & specialty items. A veritable encyclopedia of gun parts, this catalog will pay for itself with info and time saved in identifying parts.

**U.S. SEND \$7.95 (ALLOW 4-6 WEEKS) FOREIGN SURFACE
\$12.00 (IMMEDIATE UPS DELIVERY) \$13.00
FOREIGN AIRMAIL - \$25.00**

GUN PARTS CORP. BOX SF0495, W. HURLEY, NY 12491
914-679-2417 FAX 914-679-5849

STEROIDS

D-BALL TEST JET DECA

Anabolic Steroids increase Testosterone levels to Build Muscle Mass and Strength

Now there is a safe and *effective replacement* for steroids. **Boron***. Tens of thousands have used **Boron** from JTR Labs to successfully replace steroids without the harmful side effects. *Guaranteed.* Check out these results. All from **Boron** users. "...20 pounds of muscle in three months..." Willie Beck III. AL
Terry Goetz. VT. Put 90 pounds on his bench. "...two inches in my chest..." J. Ramsey. TX
"...its the extra edge I needed..." Charles Walters, Military
All these amazing gains using Boron.

For **your own Huge Increases** - Order your 3 month cycle of **Boron** today. Only \$15.95 plus \$4.00 S&H. Blow away your competition and order now.
*Boron is a safe, 100% natural nutrient

**COD's, Credit Card, Catalog orders call:
1-800-962-4769....ask for dept.#733**
Order lines open 24 hours 7 days a week
Send check or money order to:

JTR LABS
10230 Bach Blvd.
Dept.#733
St. Louis, MO 63132

HOME OF THE LIFETIME GUARANTEE

WARNING: Accept no imitations or copy cats. JTR Labs, gives you the highest quality Boron. For 6 years. Unlimited Guarantee.

Electronic Timer

shows you the easy way to build timers capable of delays of 1/10 of a second to months! Written for the non-technician, **Electronic Timer** is a fully illustrated and easy to read **manual** for the design & construction of **battery-powered timers** for use in:

- Surveillance equip.
- Security systems
- Pyrotechnics

Build your own timer

- Using commonly available parts
- Only simple hand tools required for construction
- Checklists guide you through the construction to insure success
- No printed circuit boards to etch

The manual contains basic timer theory that will enable you to customize your timer to suit your particular application. A "must have" reference in a hi-tech world. 40 pages.
To order:
Send name, address, and \$9.95 + \$2.50 S&H (check or M.O.) to:

BTN Publishing
P.O. Box 4587
Boulder, CO 80306-4587

NIGHT VISION

MoroVision continues to offer one of the widest selections of affordable, high-performance U.S. and Russian made starlight night vision devices available!

Factory-new binoculars, goggles, weapons sights, pocket scopes, and IR systems from only **\$349.00!**
Compare our unbeatable low prices and superior service!

One-Year Warranty
MONEY-BACK GUARANTEE!

Call Now for Immediate Delivery
 1-800-424-8222

M•O•R•O•V•I•S•I•O•N

219 Broadway, Suite 307/SF
Laguna Beach, CA 92651 U.S.A.
Info: 714-497-4683 • Fax: 714-497-1270

Be a DETECTIVE

SPECIAL SOF PRICES! AND EARN YOUR BADGE
NO EXPERIENCE NEEDED



MEN - WOMEN
TRAIN AT HOME FOR AN EXCITING PART OR FULL-TIME CAREER AS A PRIVATE DETECTIVE. START YOUR OWN AGENCY OR WORK FOR OTHERS. LEARN ALL THE LATEST TECHNIQUES FROM THE EXPERTS.



EST. 1973 **YOU ARE TAUGHT BY FORMER MILITARY INTELLIGENCE SPECIALISTS, POLICE AND PRIVATE DETECTIVES. "THE ONLY COURSE OF ITS KIND." YOUR PAST EXPERIENCE COMBINED WITH THE UNIQUE GLOBAL PROGRAM**

WILL MAKE YOU A PRIVATE DETECTIVE.



"Now earning \$100,000 a year as a P.I. Thank you Global."
A.R. Texas

CALL NOW 617-721-4292

NO OBLIGATION • NO SALESMAN

GLOBAL SCHOOL OF INVESTIGATION
171 S. PARK ST. STONEHAM, MA 02180

NAME _____

ADDRESS _____

CITY _____ STATE _____ ZIP _____

● **FREE INFORMATION**

Become a gun repair expert!

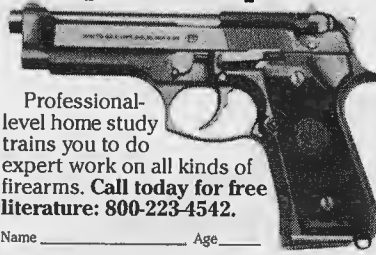

Professional-level home study trains you to do expert work on all kinds of firearms. Call today for free literature: 800-223-4542.

Name _____ Age _____
Address _____ Phone (____) _____
City _____ State _____ Zip _____

School of Gunsmithing, Dept GGE171
PCDI, 6065 Roswell Rd., Atlanta, Georgia 30328

★ SPECIAL OPERATIONS GROUP INT. ★

PARAMILITARY • SNIPER • SRT COURSES
SECURITY TEAMS/CONSULTANTS ON REQUEST



Brochure
\$5.00 Cash

Video
\$15.00

Militias
Welcome

Private
Training
Available

SOG FAX: _____
P.O. Box 94 011 81 424 80 7749
Trade, Tenn. 37691 USA

ARE YOU AN OUTLAW?

It's time to take a stand and become an official member of the United State's largest skydiving team. Outlaw colors are spotted on almost every drop zone worldwide (excluding some third world drop zones.) Las Vegas' Outlaw Skydiving Team membership kits are available now.

- SF1 T-Shirt \$15 ea.
- SF2 Cap w/3" emblem \$8 ea.
- SF3 4" Cloth Emblem Patch \$7 ea.
- SF4 2 Bumper Stickers (3 1/2 x 12") \$4 ea.
- SF5 4 - 4" Window Stickers \$2 ea.
- SF6 Membership Card w/registration \$5 ea.

(specify black or white. M.L or XLG. XXLG \$2.00 extra)

SF7 Membership Kit
(All of the above, \$41.00 value.)
\$29.95

Extra Items may be ordered at individual prices. Include \$4.00 postage & handling, Canada \$8.00. Nevada residents add 7.0% sales tax. Free stickers with each order.

Make check or money order payable to:
Outlaw Skydiving Team
P.O. Box 34917
Las Vegas, Nevada 89133-4917

Attention Collectors and Sportsmen!

SWITCHBLADES

Only \$34.95 Each!

Order 2 and save \$10 (only \$59.90) Protection at the touch of a button! Cutting Edge Ent. is proud to present the legendary **"Nato Military"** automatic knife at rockbottom prices! Lightning fast, front opening, stainless steel blade is nearly 4 in. long! Shock resistant handles, and quality construction complete the package. Don't miss out on this limited time offer! Each additional knife is only \$29.95! 24 hr. order turnaround and best price guaranteed (slight delay on personal checks). Don't delay, order now! C.O.D. orders call toll-free anytime. Send check or M.O. + \$4.95 Shipping to:



Cutting Edge Ent.
2101 W. Broadway #171
Columbia, MO 65205-6018
1-800-554-5880
TOLL FREE C.O.D. ORDER LINE!

Missouri residents please add 6.975% sales tax. Please consult local and state law before ordering, assembled knife may not be legal in all areas. Must be 18 yrs. old. Send S.A.S.E. for free brochure.

30 Day Money Back Guarantee!

Name: _____
Address: _____
City: _____ State: _____ Zip: _____
Quantity: _____ Total Enclosed \$ _____

TUF ENUF



Smart Enough To Prepare NOW

"JUST CAN'T PUT IT DOWN!"

New Booklet:
EMERGENCY !!!
How To Protect Your Family (and Yourself)

- Life saving secrets revealed!
- Predict problems before they occur!
- Know what you need before you buy!

Imagine having a survivor's checklist in your pocket for only \$9.95 + tax + \$1.50 P&H!

Prepare now. Do it.

Call or write now: **Dewey Research Center**
Box 125SF2, 3800 Dewey Ave.
Rochester, NY, 14616

VISA/MC **716-621-7379** 24 hrs.

The Power Of Night Vision

Now Starting at Only **\$395!**
(was \$495)

OUR BIGGEST SALE EVER

If you are afraid of buying Night Vision from those who know nothing about it, call Hitek for accurate information. If you are afraid to buy from importers and brokers, call Hitek for superb service. We are proud to be an American Based Manufacturer! And now, Hitek is having a sale. All prices have been slashed by at least 20%. So call Hitek International and get the best deals. Time is limited, so you must act now!

Call Now:
1-800-54-NIGHT
(1-800-546-4448) **2 Year Warranty**
Money-back guarantee!



484 El Camino Real
Redwood City, CA 94063
Tel: (415) 363-1404
Fax: (415) 363-1408



THE BODY SCULPTOR
 Develop the body you've always dreamed of having. Add inches to your chest, arms, and thighs. Sculpt your stomach, buttocks, and calves. The Body Sculptor builds & tones muscles, and relieves stress and tension. Adjustable electrical impulses work your muscles more effectively than regular exercise. It's medically proven, effortless and safe! Use it at home, in the office, traveling, even while reading or watching T.V. **Results guaranteed in 30 days or your money back!** - Less a 15% restocking fee.

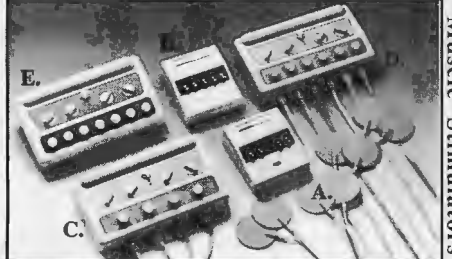

Your unit includes the following: • 24 hr. customer service • Free AC wall adapter • Complete instructions • 5 year Iron-Clad warranty • Free Carry Case • 30 day trial period
 A. BM-1004, 6-pad model w/AC adapter, \$220
 B. BM-1006, 8-pad model w/ AC adapter, \$259
 C. BM-1008, 12-pad model w/AC adapter, \$359
 D. BM-1012, 16-pad model w/AC adapter, \$459
 E. BM-1014, 18-pad model w/ AC adapter, \$499
 • Add \$10 for S&H • CA res. add 7.75% tax •
Call Now For Immediate Delivery!
 1-800-401-4677 (U.S. & Canada)
 or send money order to: David Steele
 64 Lehigh Aisle, Dept. SOF 0495, Irvine CA 92715

★★ U.S. GOVERNMENT SPECIFICATION ★★
MA-1 JACKETS



Worn by Military Personnel, Undercover Police, Mercs, Bodyguards & Bounty Hunters! Surplus stores are selling them for \$80 & more! They run small, so order BIG! S-XXXL Black, Silver, Sage Green, Navy & Maroon.

MAJOR CREDIT CARDS ACCEPTED
1-800-385-4103 **\$39.95** (includes S&H in U.S.)
HURRICANE INTL
 PO BOX 109, COLD SPRING HARBOR, NY 11724



Night Vision Rifle Scope!
 Baigish SP- 2nd Generation Scope, lighted center aiming mark.
 Only \$995.00

Also offering a full line of Night Vision Binoculars and Scopes For as low as \$195.00

Factory New, Military Style Night Vision equipment can now be yours!! Great for Home Security, Surveillance work, boating and wildlife observation. One-year warranty and the lowest prices anywhere!!!

We also offer a full line of hidden Video Equipment



World's Smallest Video Camera
 See's through a 1/32 inch hole.
 Only \$295.00



Undercover Radio Video Camera
 Video Anyone Anywhere
 Only \$375.00

First Witness Video Surveillance Systems
 300 North Central Ave., Staunton, VA 24401
Call 1-800-880-1521

Tel: (703) 886-1521 Fax: (703) 885-2342
 Visa MC



T-SHIRTS
 Man's Best Friend
 cat#001 -> IT'S ALRIGHT TO BE WHITE
 <- cat#008
FLUSH
 DAP <- cat#005 **I DON'T GET MAD**
 DOWN THE TRAP **I GOT 'EM**
 cat#010 ->
 Black Ts - full color designs
 M-XL \$15/XXL \$17/USA & \$3 S&H, \$1 ea add'l
 Calif. residents add 8 1/4% tax
 Foreign/\$8 S&H, \$3 ea add'l
 Catalog - \$1 & 29c stamp
 Send ck or mo to:
 PIG (Politically Incorrect Graphics)
 P.O. Box 2147AS, Orinda, CA 94563
 Credit Card orders call (510) 531-5028

Exhibitors
16th ANNUAL
SOF EXPO

SANDS CONVENTION CENTER
LAS VEGAS, NEVADA

Show dates & hours
 Sept. 29, 1995 1000 — 2000 hrs
 Sept. 30, 1995 0900 — 1800 hrs
 Oct. 1, 1995 0900 — 1600 hrs

Our 1995 SOF EXPO will be held at the Sands Convention Center, Las Vegas, Nevada. Products displayed and available for purchase include military equipment, weapons, ammo, gun parts, holsters, misc products, optics/scopes/mounts, police equipment, re-loading, security, surplus, training and many more!!

Reserve your space now: Exhibitors are reserving space and we are 60% booked. Don't miss this exciting opportunity to sell your merchandise to an entirely new group of potential buyers. For info on the 1995 SOF EXPO call: (303) 449-3750 Fax: (303) 444-5617, or write to

SOF '95 Convention
P.O. Box 693
Boulder, CO 80306

CAPITALIZE ON CRIME

IT CAN PAY HUGE PROFITS!
 CRIME PREVENTION IS A MULTI-MILLION DOLLAR BUSINESS!
 OUR DEVICES SELL LIKE CRAZY

We carry the best line of security sprays, stun guns, personal sound alarms, burglar alarms and much more. We specialize in offering the best security products at the very best wholesale prices.

10% Pepper Sprays Personal Sound Alarm
Key Chain **4 oz. Fogger**
 Sprayer
 Retail \$19.95 Retail \$34.95
 Sample \$7.95 Sample \$10.95

Electronic Stun Guns
Security Plus **Security Plus-Maxo**
 100,000 Volt 200,000 Volt

 Retail \$69.95 Retail \$119.95
 Sample \$29.95 Sample \$39.95

CALL OR WRITE TODAY!
 We are committed to your success. Crime does not wait! Will you?

L.A. LAW ENFORCERS
 1005 N. 1st Street, Dept. SOF
 Yakima, WA 98901
 (800) 967-8133 • FAX (509) 575-1875

GENUINE BRITISH MILITARY KIT

- BRITISH DPM SAS SMOCKS
- BRITISH DPM PARA SMOCKS
- BRITISH DPM JACKETS ('68 PAT)
- BRITISH DPM TROPICAL SUITS
- BRITISH WOOLEY PULLY'S
- BRITISH DENISON SMOCKS
- BRITISH WEBBING FLCE, '58, '37
- BRITISH DPM DESERT SUITS
- BRITISH RUCKSACKS
- BRITISH DRESS UNIFORMS
- BRITISH POLICE KIT
- BRITISH PARA/SAS BERETS/BADGES
- BRITISH G10 ARMY WATCHES
- BRITISH W.W. II KIT

Orders dispatched by air mail £17.99 per order Visa/MC accepted.

Send for FREE catalogue to: Silverman's (SOF), Mile End, London E1 4PS. England
 Phone 011-44-71-790-5257
 Credit card orders 0717-900-900
 Fax 011-44-71-791-0008

NAME _____
 ADDRESS _____
 CITY _____
 STATE/ZIP _____

WARNING! Don't Get Fooled By Frauds.
 Other companies claiming to have similar, better or
 all in one products can't compare because of mg
 dosage ask compare and beware.

STEROIDS

Alternative

This product is to be taken orally.
 100% Natural, No harmful side effects.
 S&K Labs **Dibencozide!**

Can greatly increase your Muscle mass strength
 and size. Greatly enhance your physical appear-
 ance literally sculpting your own body with huge
 healthy, hard muscle. Most people say the
 effects from Dibencozide are more than equal to
 Dianabol™, the "illegal Steroid."

Get that Lean awesome body builder physique
 now with one 2 month cycle for only \$22.50!
 If you are not completely satisfied with the growth
 you obtain within 15 days return it for a full refund.

Money back guarantee!

To get your super anabolic growth cycle from:

S&K Labs

C.O.D. Order Now!!! \$22.50 + Shipping
 Cash On Delivery Welcome
1-800-275-7822

Special Buy 2 Bottles, Get 3rd bottle FREE
 Call Toll Free-24 Hrs. a day-7 days a week
 Or Send Check or Money Order To:
 S&K Labs 2637 E. Atlantic Blvd., Suite 101
 Pompano Beach, Florida 33062

One bottle (2 month cycle)
 \$22.50 + \$4.00 S&H

SPECIAL BUY 2 BOTTLES GET 3RD BOTTLE FREE
 \$45.00 for 3 bottles + \$4.00 S&H

Add \$10 for Priority Mail

Out of Country Orders + an Additional 25% **C.O.D. U.S. Only**

Name: _____
 Address: _____
 City, State, Zip: _____
 Phone () _____

**LEGIONNAIRES
 SURVIVAL
 BOOT KNIFE**



ONLY
\$12.95
 Add \$1.05 Hndl.

Model
K-99-A

Overall 9"

Double edge 440 stainless steel blade. Full
 tang one piece construction. Leather sheath
 with quick release snap and metal boot/belt
 clip. Money Back Guaranteed If Not Fully
 Satisfied!!

WESTBURY SALES CO. DEPT BK-04-SF
 156 Post Avenue, Westbury, New York 11590

NOTICE TO SUBSCRIBERS

From time to time, we make our list of cus-
 tomers' names and addresses available to
 carefully screened companies to send an-
 nouncements of their products or services.

If you prefer not to receive such mailings,
 and want your name on our subscriber list
 only, please write us, enclosing your mail-
 ing label.

Please address your request to:

SOLDIER OF FORTUNE
 P.O. Box 348
 Mt. Morris, IL 61054
 Attn: Customer Service

**NOTICE TO
 CALIFORNIA RESIDENTS**

Some firearms advertised in this magazine
 may or may not be lawful for sale in California.

Those specifically not allowed for sale in California are:

A. All of the following rifles:

1. Avtomat Kalashnikovs (AK) series
2. UZI and Gall
3. Beretta AR-70 (SC-70)
4. CETME C3
5. Colt AR-15 series and CAR-15 series
6. Daewoo K-1, K-2, Max 1, and Max 2
7. Fabrique Nationale FN/FAL, FN/LAR and FNC
8. FAMAS MAS223
9. Heckler & Koch HK-91, H-93, HK-94 ,PSG-1
10. MAC 10 and MAC11
11. SKS with detachable magazine
12. SIG AMT, SIG 500 Series, and SIG PE-57
13. Springfield Armory BM59 and SAR-48
14. Sterling MK-6 and SAR
15. Steyr AUG
16. Valmet M62, M71S and M78
17. Amalite AR-180 Carbine
18. Bushmaster Assault Rifle (amgun)
19. Calico M-900 Assault Carbine
20. Mandall THE-TAC-1 Carbine
21. Plainfield Machine Company Carbine
22. PJK M-68 Carbine
23. Weaver Am Nighthawk

B. All of the following pistols:

1. UZI
2. Encom MP-9 and MP-45
3. MAC 10 and MAC 11
4. INTRATEC TEC-9
5. Mitchell Arms Spectre Auto
6. Sterling MK-7
7. Calico M-900

C. All of the following shotguns:

1. Franchi SPAS 12 and LAW 12
2. Gilbert Equipment Company Striker 12 and
 SWD Street Sweeper
3. Encom CM-55

SOLDIER OF FORTUNE MAGAZINE

B.G.W.

CLASS II
 MANUFACTURER OF
 SUPPRESSORS & EXOTIC WEAPON SYSTEMS
 FOR THE SILENT PROFESSIONAL.



Photo by Terry Williams

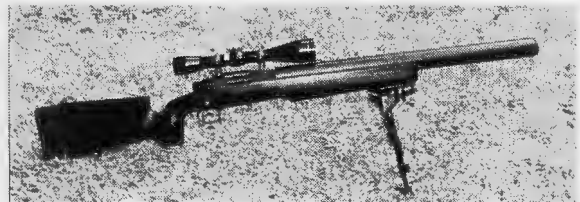

BGW's 300 Anabis Tactical Weapon System.

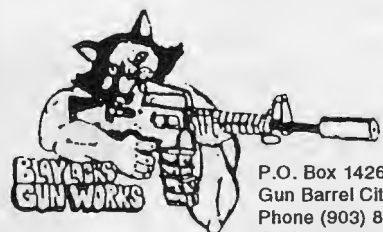

P.O. Box 1426
 Gun Barrel City, TX 75147
 Phone (903) 887-2655
 FAX (903) 887-4796

FOR CATALOG SEND \$2.00 or
 DEALERS SEND FFL & EIN

CLASSIFIEDS

CURRENT REQUIREMENTS — 2.00 per word per insertion — \$40.00 minimum. All ads **MUST BE PREPAID**. Ad copy must be typed or written clearly with authorizing signature, a telephone number (for our files) and full payment. Advertisers offering information packets for a fee must send sample of packet (packets will not be returned). Name, address and telephone number are to be included in your word count. **EXAMPLE:** P.O. Box 693 = 2 words; 80306 = 1 word. Abbreviations such as DI, SGT, 20mm, U.S. count as one word each. Hyphenated words and telephone numbers are counted as two words. No personal services ads accepted. We reserve the right to refuse, delete or change any copy which we determine to be objectionable. Mail classified ads with payment to **SOLDIER OF FORTUNE, Classified Dept., P.O. Box 693, Boulder, CO 80306.**

NOTICE TO READERS

SOLDIER OF FORTUNE Magazine is a magazine of national and international distribution. There may be products for which sale, possession or interstate transportation may be restricted, prohibited or subject to special licensing requirements in your state. Purchasers should consult the local law enforcement authorities in their area.

READERS OF BOTH DISPLAY AND CLASSIFIED ADVERTISING ARE ADVISED THAT SOLDIER OF FORTUNE MAGAZINE DOES NOT VERIFY VALIDITY OF EVERY ADVERTISEMENT AND/OR THE LEGALITY OF EVERY PRODUCT CONTAINED HEREIN. SHOULD ANY READER HAVE A PROBLEM WITH PRODUCTS OR SERVICES OFFERED BY AN ADVERTISER, HE SHOULD SEEK ASSISTANCE FROM HIS NEAREST POSTAL INSPECTOR AND ALSO CONTACT OUR ADVERTISING DEPARTMENT. SOLDIER OF FORTUNE DOES NOT INTEND FOR ANY PRODUCT OR SERVICE ADVERTISED TO BE USED IN ANY ILLEGAL MANNER.

SOLDIER OF FORTUNE DEADLINES FOR ALL CLASSIFIED ADVERTISING

'95 Issues	Deadline
July	March 17
August	April 21
September	May 19
October	June 21
November	July 21
December	August 18

**Classified Dept., P.O. Box 693
Boulder, CO 80306-0693
Classified ads cannot be taken over telephone**

Street Lethal SPEED KILL

- Can you hit a man 11 times or more in one second or less?
 - Can you drop a man to his knees with one blow?
 - Can you win a fight in 3 seconds or less?
- WE TRAIN PEOPLE WHO CAN! FREE DETAILS**
Warrior Publications
6252 Dark Hollow Rd., Medford, OR 97501 (503) 535-3188
CUT OUT AND MAIL THIS AD TODAY!

The Ultimate Utility Knife!

- 17 functions - Stainless Steel
Quality, Reliability, Durability!

scaler
pliers
tree saw
tweezers
flat. screw
phillip screw
bottle opener



awl
ruler
scissors
toothpick
corkscrew
magn. glass
fish dislodger

Only \$ 9.95 !!!

Send check or money order, plus 2.00 s/h to:
Cosentino Trading Box 945 Malibu, CA 90265

LATIN AMERICAN LADIES!



Seek Marriage! Confidential service includes a 400 (+) Photo Brochure, video, introductions, and group-tours. (\$1.00 brings photos/details).

T.L.C. WORLDWIDE, INC. (713) 896-9224
P.O. BOX 924984 HOUSTON, TEXAS 77292-4994

UNDERGROUND BOOKS

How to Get Anything on Anybody.....\$30
Personal Defense Weapons.....\$10
Home Workshop Explosives.....\$14
Shadows and Surveillance.....\$15
The Big Book of Secret Hiding Places.....\$15
Privacy, How to Get It, How to Enjoy it.....\$18
Rip-off Book.....\$12 The Paper Trip I.....\$17
Identification..\$10 Take no Prisoners..\$10
The Outlaw's Bible...\$15 Exotic Weapons..\$15
Reborn in the U.S.A...\$15 Armed Defense..\$15
Drug Testing at Work...\$17 Silent Death.....\$15
Psych. Chemistry...\$16 FS Catalog.....\$2
Adults Only! CA Res. Add 7.75%
Free Shipping! Fast Service!
Air Mail Delivery Add \$2 Per Book
Checks & Money Orders Accepted
Credit Cards Orders 800-635-8883
Customer Service 916-771-4203
FS Book Co., P.O. Box 417457
Dept. SF, Sacramento, CA 95841



.625 MAGNUM™

-BEWARE-

The World's Most Powerful Blowguns are **DOWN & DIRTY!**

Write or Call For Immediate Info.

J.W. McFARLIN COMPANY

P.O. Box 209, Lake Havasu City, AZ 86405-0209
Tel. (520) 655-8095

"OFFICIAL MILITIA WEAR" T-shirts for active Patriots. Striking. Different. Free catalogue: On Design Group P.O. Box 45498SF, Phoenix, AZ 85064-5498. (210)

VIETNAM VETERAN/MARINE corps/army paratrooper (Issue Jump Wings) Three Unique and Creative Embroidered Cap Designs One Size Fits All - Black \$16.95 each includes shipping and handling. Mail check or money order to: **SOLDIERS CHOICE P.O. Box 1049 Tulsa, Oklahoma 74101-1049 (212)**

We the people, **WILL NOT DISARM**. T-shirt red on white, white on black, white on red. Send \$12.00, size, color, front or back, to: Deb Hill 4634 S. Independence St. Littleton, CO 80123 (no personal checks). (210)

PATRIOTS! Get your beautifully designed T-Shirts and Sweatshirts here. Several designs to choose from. Competitively priced! Free Brochure! Burnham, P.O. Box 376, Nevada, MO 64772. (213)

OUTSPOKEN-CONSERVATIVE TEES. Send SASE for Free Catalog. Shirthing, 1262 Beryl St., Ste. 45, Redondo Beach, CA 90277. (210)

BOOKS & PUBLICATIONS

MEN OF ACTION AND ADVENTURE - Paladin Press has been described as "the most dangerous press in America." Millions of satisfied readers disagree. Outrageous and controversial books and videos on firearms, exotic weaponry, new identity, creative revenge, espionage and investigation, privacy, action careers, and more! To order our 64-page catalog send \$2.00 to: **PALADIN PRESS, Box 1307-5AQQ, Boulder, CO 80306, (303) 443-7250. (212)**

NUDISM LIFESTYLE: FAMILY RECREATION

Publications • Videos

\$3 for details:

LIFESTYLES-SF

Box 661268, Los Angeles, CA 90066

PAGER HOLSTER



•Fast. Safe. Discreet •Press Button, Case Front Pops Open •Hinges Down Allowing Quick Draw of Gun •Clips to Belt •Fits. Bauer, Davis Derringers (.22, .25, & .32), Baby Browning, .25 Autos, PSP & Ivar Johnson .25, NAA 22 LR 1 1/8" BBL, Freedom Arms 22 LR 1" BBL

\$19.95 each

plus \$2.00 postage & handling
TWO for \$34.95 plus p & h

SeeR, Inc.
P.O. Box 20783
Waco, TX 76702-0783

"SHOOT FIRST SECURITY"

Products: DECALS 3/\$3.00 SHIRTS \$14.95, 5 SIZES; 3 COLORS; navy blue, maroon, white, 2 STYLES left front chest, full front

CAPS \$6.95. Shipping + \$2.00 per order/shirts, \$1.00 order/caps.

THINK FIRST Dept SOF 5020 SANDMANN DR, COVINGTON, KY 41015
We take phone orders (606) 581-6030

APPAREL

MILITARY UNIFORMS FROM 50 NATIONS! Newly Updated Catalog of Rare & Unique Military Camouflage Uniforms from around the World. \$1.00 A.H.A., Box 21606, Denver, CO 80221. (210)

FRENCH FOREIGN LEGION T-Shirt with Legion Motto in French and Latin! \$10.00 each! **WOLFGANG, Box 709H, Prudenville, MI 48651. (211)**

FOREIGN CAMOUFLAGE, insignia and field gear. All countries, all periods. Send \$1.00 for catalog: **World Wide Militaria, P.O. Box 522, Germantown, MD 20875. (210)**

AMMUNITION

HIGH CAPACITY MAGAZINES for AR15, Mini 14, AK47, UZI, SKS, and more! Thermold Fiberglass Millspec and Metal. Great prices! (305) 584-9211. (210)

THAI ASIAN WORLDWIDE

LADIES 270 Photo Catalog
Beautiful Women Around
The World Seek Loving Men
TAWL Box 937(SOF) Kailua-
Kona, Hawaii 96745. FREE
Brochure 808/329-5559



Mark Koernke

"all new"

Militia Videos

LATEST INFORMATION



You've seen "America in Peril"

Now, the latest updates by this former Army Intelligence Analyst. Nobody deals with the details and "nitty gritty" like Mark. See and hear for yourself the "prime source" of current Militia info.

- Tape #1 Columbus Ohio — Taped in a private home meeting.
- Tape #2 Tactical Update I — Home Meeting discussion.
- Tape #3 Tactical Update II — Continuation at later date.
- Tape #4 Special public meeting in Livonia Michigan.

Prices \$20 ea. two or more \$15. Plus postage and handling

CALL THE "HOTLINE" — 517 263-1078 24 HRS. CALL NOW!

(Call now — and receive "confidential" Army Counterintelligence Manual as a Free Bonus.)
Call right now! We ship in 24 hrs.

RÜSSIAN MILITARY



The only survival knife versatile enough to be the official issue of the Elite Russian Special Forces.

- Double serrated saw back.
- Sturdy handle with keep dry storage.
- Individually inspected and numbered to insure quality and provide a unique collectible.
- High carbon steel blade measures 9.5 x 3.5 x 3/8, with a total length of 14.8" . Weighs 1.54 Lbs
- Screw on ice pick recessed in handle.
- 3 stamped holes for stripping wire and more.

Call Toll-Free 1-800-825-9387

Or send check or Money Order for \$44.95 plus \$5.00 for shipping and handling to:
Alekol International, Dept. NZ3010 Hennepin Ave S., #128
Minneapolis, MN 55408

SURVEILLANCE & COUNTERSURVEILLANCE Electronic Devices

Covert Video Cameras • Transmitter Kits • Voice Changers
Bug and Phone Tap Detectors • Shotgun Mics • Micro Recorders
• Vehicle Tracking • Locksmithing • AND MORE!

16 - Hour Telephone Recorder - silently tapes incoming/outgoing phone calls automatically. \$199.00

SDY FOR CATALOG SEND \$5.00 TO... CREDIT CARDS WELCOME
OUTLET P.O. Box 337, Buffalo, NY 14226 (716) 691-3476

"THE ROLLS ROYCE OF COMBAT CLOTHING"

'Combat & Survival Magazine' Now in Genuine US Woodland Cammo!!!



Lots more UNIQUE SASS combat clothing and equipment in our FREE colour catalogue. For your copy please send \$2 (bills only) to:

SPECIAL AIR SEA SERVICES

ST. GEORGE'S WORKS,
ST. GEORGE'S QUAY,

LANCASTER, LANCASHIRE, LA1 5QJ
ENGLAND

Ph: (011-441524) 64204 fax: 844239

BE AN ELECTRICIAN!

Home study. Make good money—maintain, install wiring in homes and businesses: electrical systems, cable, controls, utilities, phones, and more. Free literature: 800-223-4542.

Name _____ Age _____
Address _____
City _____ State _____ Zip _____
The Electrician School, Dept. TEE171
PCDI, 6065 Roswell Rd., Atlanta, GA 30328



YOUR MILITARY MEDALS!



LARGEST INVENTORY IN THE U.S.A.!

- FULL SIZE US MEDALS
- UN AND RVN MEDALS
- MINIATURE MEDALS
- OFFICIAL RIBBONS
- RANK BADGES . PATCHES... ALL GUARANTEED!
- SKILL BADGES
- DISPLAY CASES
- MANUALS ON CLAIMING MEDALS

SEND \$2.00 TODAY FOR ALL NEW COLOR CATALOG!

MEDALS OF AMERICA

1929S2 FAIRVIEW ROAD
FOUNTAIN INN, S.C. 29644

SPECIAL FORCES Peak Conditioning Manual. Train and look like the men in SF. Includes Diet, PT, Running, and Weightlifting Routine. Get strong and tough! RUSH \$11.95 to THE ELITE, P.O.Box 600130, Lake Hiawatha, NJ 07034. (211)

DO YOU KNOW THE ENEMY? IntelCom, Inc. does. Do you need open source military information on any of the world's aggressor nations such as Iraq, Iran, Libya, North Korea or Cuba? If so, please call (908) 873-8146 or send two dollars for a brochure to: IntelCom, Incorporated 42 Cedar Brook Drive, Somerset, NJ 08873. (210)

MILITARY PUBLICATIONS international directory. Unique! Helps you contact over 600 specialist war journals, world-wide. Weaponry/history/combat. Guaranteed. \$15. Essay, Suite E-243, 601 S. LaSalle, Chicago, IL 60605. (211)

MILITARY/INFO PUBLISHING. We produce unique books on Military Science and Technology. For catalog. Send \$2.00 to: Military/Info, P.O. Box 27640-SF, Golden Valley, MN 55427. (210)

U.S. ARMY HERALDIC CRESTS: Complete Illustrated History of Authorized Distinctive Unit Insignia, all crests illustrated in full color, \$53.96. The Panama Route, 1848-1869, \$22.50. Lejeune: A Marine's Life, \$22.50. Order by mail. Please add \$2.00/book for shipping and handling, and if SC resident add sales tax. Many, many other titles available. Free list. Columbia Light Horse Military Book Store, P.O. Box 551, Columbia, SC 29202-0551. (210)

DIRECTIONS FOR SURVIVAL, Americas oldest survival and self-reliance newsletter is better than ever. Get 12 great monthly issues plus membership in Americas oldest and largest survival organization for only \$20.00. Sample and information \$2.00. Live Free, Box 1743, Harvey, IL 60426. (210)

BEST BOOK YET on Vietnam—SOF. "We Were Soldiers Once and Young." Hardback edition autographed by authors Moore and Galloway. \$25 check or MO to Shiny Bayonet P.O. Box 544-SOF Nokesville VA 22123. (212)

BUSINESS OPPORTUNITIES

LET THE GOVERNMENT FINANCE your new or existing small business. Grants/Loans to \$500,000. Free recorded message: (707) 449-8600. (KW5) (214)

FREE INFORMATION! Allow the Government to finance your small business. Loans/Grants to \$687,900. Call 24 hour, free recorded message: (810) 825-6700, Dept. 1422. (210)

NEED FUNDS/CAPITALIZATION for your idea, product, business? Focused investors now considering serious proposals. \$150,000 to \$2,500,000 (plus) available. Send \$10.00 check, money order for information letter and application: Unsworth Venture Capitalists, 125 Saddlebridge Ct., Jacksonville, NC 28540-9159. (210)

COLLECTORS

MILITARY COLLECTIBLES: WWI/WWII/Korea/Vietnam. CURRENT: Patches/Badges/Rank Insignia/etc. Catalog \$4.00. Phone (408) 295-1136 or FAX (408) 288-6350 or write: LEE-JACKSON MILITARIA, P.O.Box 8663, San Jose, CA 95155-8663. (212)

VIETNAM WAR INSIGNIA and Uniform List. I mail a list of Vietnam War Militaria six times per year. Lists are \$4.00 each. Insignia are pictured so you know what you are buying. I always have a nice collection of original patches, insignia, books, maps, uniforms, field gear etc. Both U.S. and VC/NVA. I also buy singles and collections of Vietnam War souvenirs. 100% guarantee from me. Buy with confidence. BILL BROOKS, P.O.Box 230832, Montgomery, AL 36123. (217)

BRITISH/SCOTTISH Militaria Collectors. Regimental insignia and accessories of elite Regiments; including SAS; Paratroopers; Royal Marines; Black Watch; Guards, etc. Import Catalog \$6.00. BRITISH REGALIA IMPORTS, Department 6, P.O.Box 50473, Nashville, TN 37205. (210)

SUBSCRIBE

TO THE MAGAZINE THAT MORE THAN 10,000 READERS TURN TO FOR ARTICLES, ADS & NEWS ABOUT MILITARY JEPS, TRUCKS, TANKS & MORE!

Full listing of upcoming rallies.

MILITARY VEHICLES

MAGAZINE

USA: 1 Year (6 Issues) \$15 • 2 Years (12 Issues) \$25
Canada: 1 Year \$24 • 2 Years \$44. All Others: 1 Year \$26 • 2 Years \$46

P.O. Box 1748-L • Union, NJ 07083

THE MARKETPLACE
FOR MILITARY VEHICLES

SOLDIER OF FORTUNE Magazine Binder. Holds 12 issues, \$12.00 plus \$4.00 P&H. VISA/MC accepted. No COD's. SOF BINDER, P.O.Box 693, Boulder, CO 80306. (212)

BOOKS ON AFRICAN WARS, hunting, politics. Catalogue \$2 write: Lemur Books, P.O. Box 1645, Alberton, 1450, SOUTH AFRICA: Fax 011-869-0890. (219)

WHO KILLED KENNEDY? Assassination research materials: Videocassettes, photographs, books, unpublished manuscripts, Catalogue: \$3.00. Collector's Archives, Box 2, Beaconsfield, Quebec, H9W 5T6 CANADA. (216)

Men & Women! Be A...

PRIVATE EYE



Amazing one-of-a-kind home study course tells all! Want a life of intrigue, excitement, adventure?! Quickly learn from the experts:

- How To Earn \$100,000 A Year As Your Own Boss!
- How To Conduct All Types Of Private Investigations, Skiptracing & Surveillance!
- How To Start Your Own Private Detective Agency!
- How To Work From Home, Part-Time or FullTime!
- No Experience Necessary, No Investment Required!

STATE APPROVED

Located in the Entertainment Capitol Of the World! (213) 879-1165

FREE DETAILS

UNITED STATES ACADEMY OF PRIVATE INVESTIGATION
P.O. BOX 2133 (SF)
BEVERLY HILLS, CA 90213

UNUSUAL BOOKS

MANY AVAILABLE NOWHERE ELSE
100's of Titles to Choose!

CREDIT • EMPLOYMENT • EXOTIC WEAPONRY • MARTIAL ARTS • PRIVACY • NEW IDENTITY • DISGUISES • SURVEILLANCE • FIREWORKS and Much, Much More!
Best Prices and Selection. Money Back Guarantee.
Catalog\$1.00

ALPHA PUBLICATIONS
PO Box 308-M Sharon Center, OH 44274

THE WORLD'S MOST FASCINATING POLICE CATALOG!



Bail Enforcement Agent

No. M136.....\$2995
Badges, Fake Passports, Certificates, I.D. Cards(100's to choose from), CIA Clothing, Spy Equipment, Send \$4.00 for 100 pg. color catalog or Call 1-900-226-2444

NIC, Inc. 500 Flournoy Lucas Rd. Bldg. #3-135
S'port, La. 71106 Order Line: 318-688-1365

STAR LAZER

RUSSIAN WHOLESALEERS



For all your Russian militaria

Night & Day optics, badges, medals, uniforms and naval antiques

Sales Office:

P.O. Box 1191

Lane Cove, NSW 2066, Australia

Phone: (011) 61 2-417-8824

Fax: (011) 61 2 417-8871

Speak to Bala

MEET WOMEN WORLD-WIDE

CHERRY BLOSSOMS
190FT Rainbow Ridge
Kapaa, Hawaii 96755
1(408)980-7488



FREE 32 page Photo Catalog
WORLD FAMOUS SINCE 1974

MEDALS MILITARY AND CIVILIAN



Quality with a Low Price. Full size only. Everything guaranteed. Patches also. Trades welcome. Write to:

J&S Sales

P.O. Box 40445 • Grand Junction, CO 81504
Telephone (303) 523-0314

UNITED NATIONS ITEMS: BERETS, Enlisted Blue Beret with Enamelled Crest Unissued \$30.00, BERET as worn by BRITISH OFFICERS with Wire Embroidered U.N. Badge, Unissued \$40.00. U.N. Baseball Caps with Patch \$20.00 A.H.A., Box 21606, Denver, CO 80221. (210)

WWII RELICS! Cheaper than certain "well-known" relics dealers! We beat their prices for flags, daggers, medals, helmets. Illustrated catalog \$5.00 (refundable). Telephone: (612) 689-1146. MILITARIA, Box 261-D, Cambridge, MN 55008. (212)

RHODESIAN AND SOUTH AFRICAN badges, medals, and uniforms to sale. For a list send \$1 to KAPLANS, Box 890638, Lyndhurst 2106, South Africa. (210)

EDUCATION

TERMPAPER ASSISTANCE. 19,278 topics available! 306-page catalog—rush \$2.00. Research, 11322 Idaho, #206EX, Los Angeles, CA 90025. TOLL-FREE HOTLINE: 800-351-0222 or 310-477-8226. (214)

EMPLOYMENT

OVERSEAS, STATESIDE. \$100-\$1,000 daily. Now hiring. FREE list. ZINCS 117, Box 585, Dearborn, MI 48121-0585. (214)

FEDERAL LAW ENFORCEMENT Employment Guide 37 page booklet detailing 33 Federal Agent/Officer careers. Job Descriptions, Qualifications, Application Procedures, Salaries and more. Send \$9.95 to: FCF Employment Guide, P.O. Box 2176, Brunswick, GA 31521-2176. (210)

FINANCIAL

SMALL BUSINESS — Let the Government finance you! Loans, grants, and assistance included! Satisfaction guaranteed! Call toll free: 1-800-226-3601, extension BF7770. (210)

FIREARMS - ACCESSORIES

NATIONAL MILITIA NEEDS YOU! United States Special Field Forces: Government chartered, leaders as volunteer officers in home town. Courageous, self-reliant 18 or older. \$5 brings information and application for commission. Write: GENERAL, Box 432, Camp Bradley, FL 32066. (212)

COLLECTORS & SPORTSMEN AUTO KNIFE BLOWOUT!

\$39⁹⁵ ea.

2 For \$64⁹⁵
Plus \$4 Ship/ Hndl



#102
#104

#102 NATO MILITARY
3 1/4" Stainless blade. Front opening, fast lever-action.
#104 THE GODFATHER.
Stiletto. 4" lightning-quick side open stainless steel blade.
Lifetime Money-Back Guarantee.

Order 2 knives & get **FREE!** Swiss Army Knife

Check or M.O. to **PERFORMANCE KNIVES**

1202 Lexington Ave (Rm 192) Dept. SA-4, New York 10028

Limited offer, ACT NOW **1-800-324-4371**

FOR SALE

FOR SALE: JEEP 1955 WILLEYS, ground up restoration. Must see to believe! \$10,000 invested. Make an offer. Call #304-472-6691 evenings. (210)

UNIFORMS FROM AROUND THE WORLD, Camouflage Uniforms from over 500 Countries, 16 page Catalog \$1.00 I.M.S., Box 21606, Denver, CO 80221. (210)

FREE

FREE CATALOG. Military/Education Diplomas, Certificates, Awards, any high school, university, government dept. New European & corporate coat of arms. COUCH POTATO PUBLISHING 4211 Little Road, Suite 9, New Port Richey, AL 34655, U.S.A. (210)

INSTRUCTION

INVESTIGATION CAREER. Quick, easy home study. 12 lessons. Become a professional. Free information. Shaw Investigation (Since 1971). Call (800) 272-6680. (210)

SKS FULL AUTO CONVERSION. No modification, alteration or deletion of original parts. Simple illustrated instructions \$10. Sardakar, Box 38531-S, Germantown, TN 38138. All BATF Rules Apply. (215)

TATTOOS - Build your own tattoo gun. Cheap, easy from household items. Illustrated instructions \$20.00. SLC P.O. Box 1209 Rialto, CA 92377. (211)

FREEDOM COUNTRY



20 BIG acres in WESTERN MONTANA, starting at \$9850. Trout fishing, backpacking, camping. Elk, deer, moose, bear. ADJACENT to National Forest, near established towns. Yellowstone and Glacier National Parks nearby. **GUARANTEED ACCESS, INSURED TITLE, WARRANTY DEED.** FREE color brochure, photos, maps.

FULL MONEY-BACK GUARANTEE

"Video Available"

CALL TOLL FREE 1-800-592-5990

TREASURE STATE RANCHES

210 Milwaukee Street, Dept. S

Deer Lodge, Montana 59722 — (406) 846-1000

Need NEW ID? CREDIT • PRIVACY

OUR BOOKS HELP YOU GET: New identity & credit
• Jobs in 48 hours • College degrees • ID by mail
• Cash income • Private loans • Home businesses
• Offshore banking • Foreign passports & MORE!

FREE 48 pg. **PRIVACY CATALOG:** 800-338-8484
EDEN PRESS • Box 8410-PS • Fountain Valley, CA 92728

INVESTIGATIVE TRAINING MANUALS Missing Persons, Backgrounds, Surveillance, Workers' Comp, Liability. Only \$14.95 each! Barber & Associates Investigations 1101 West Lincoln Avenue, Suite 145, Anaheim, CA 92805 (714) 740-8745. (211)

KNIVES - BAYONETS

COLD STEEL, Spyderco, Gerber, SOG and more. Huge discounts! Free List. KNIVES PLUS, 2467 Interstate 40 West, Amarillo, TX 79109. (806) 359-6202. (212)

KNIFE REPAIR. Blades, tips, modifications, restorations, sharpening, serrations. Micarta handle upgrades, double-edges, folders to swords. Tom, (813) 693-1913. (210)



Personally Signed To You
"COMBAT BABE"
\$10 POSTERS
 MISS BUSY BODIES, Inc.
 2809 Bird Ave., Suite 269
 Miami, FL 33133
 Visa/MC 1-305-445-1645

ARREST Violators!



BE YOUR OWN BOSS!
USE SECRET EQUIPMENT

Surveillance Equipment, Criminology Kits, Badges, Briefcase Telephones, Leg Holsters, Lockpick Kits, Bullet-Proof Vests, Infrared Night Scopes, Rappelling Equipment — Plus Much, Much More

Wear the Badge of a DETECTIVE

NO PREVIOUS TRAINING NEEDED

Your spirit of adventure, danger, and self reliance can lead you to an exciting career opportunity. Solve mysteries, bring criminals to justice, protect the innocent. Experts guide you every step of the way. Men and women needed to work in challenging situations, withstanding hardships, make on the spot decisions. Learn the latest investigative techniques using special law enforcement equipment . . . the same equipment used by the FBI, the CIA, and the Secret Service. Start your own investigative agency. Save up to 25% and more on all equipment. Send for free details.

Approved by Calif. Dept. of Public Instruct.

THE ROUSE SCHOOL of Special Detective Training
 Dept. SG504 P.O. Box 25750, Santa Ana CA 92799

Name _____ Age _____
 Address _____
 City/State/Zip _____

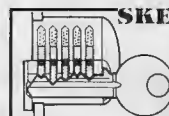

SKELETON KEY
 Amaze Your Friends

With A Lock Picking Demonstration. You get 3 sized tension keys, the slide pick, precise instructions & more. Note: this device is to be used for demonstration purposes only! Satisfaction Guaranteed or Full Refund; 2 weeks delivery. To get this exciting device. Send Now ONLY \$8.95 + \$2 S&H to: Safe Marketing, 90 W. Montgomery Av No.366SF, Rockville Md 20850.

CAMOUFLAGE PASSPORTS

NEED ALTERNATIVE IDENTIFICATION?

FOR TRAVELERS THAT REQUIRE A SECOND IDENTITY, WE CUSTOM MAKE PASSPORTS FROM EIGHT COUNTRIES.

CUSTOM MADE LEGAL SECOND PASSPORTS WITH YOUR PHOTO AND PERSONAL DATA, PLUS TWO BACK-UP ID CARDS - \$150 - ONE WEEK DELIVERY.

SEND \$2 FOR INFO AND BROCHURE
SAFEGUARD SERVICES
 P.O. Box 689-FP Ely, NV 89301
 (702) 289-4229

MISCELLANEOUS

ASIAN WOMEN Desire Correspondence! Overseas, sincere, attractive, traditional. Free details! Sunshine International Correspondence, Box 5500-ZH, Kailua-Kona, Hawaii 96745 (808) 325-7707. (210)

LOST DOCUMENTS REPLACED. College Degree, High School Diploma, Birth, Baptismal, Military Awards, Purple Heart, Silver/Bronze Star. Free Application (305) 568-1480 (24hrs). (213)

BEAUTIFUL, Traditional, Romantic Asian ladies desire friendship and marriage. Free photo brochure. **ASIAN CONNECTIONS**, Box 1230, LaGrange, TX 78945. (409) 242-5820. (210)



SEND OR CALL FOR FREE COLOR CATALOG
 Catalog containing rifles, parts, accessories, scopes, mounts, stocks, magazines, muzzle brakes and 100's of other products for SKS, MAK90, Hakim, AK 47 and other firearms.

FEDERAL ARMS CORPORATION of America

7928 University Avenue N.E.
 Fridley, MN 55432
 612-780-8780 • FAX 612-780-5747

GORGEOUS ASIAN WOMEN

DESIRE PENPALS, ROMANCE, MARRIAGE!
 Details, color photos — \$1:
 P.I.C., P.O. Box 461873-SF,
 Los Angeles, CA 90046



U.S. MILITARY INSIGNIA
 1940 through Current
 Large Catalog, \$3.00
SAUNDERS
 Box 3133 • SF • Naples, FL 33939-3133

SPY Shop U.S.A.
LARGEST SPY CATALOG IN THE INDUSTRY
 691 Pages of Stuff too Hot to Handle for Local Stores! Unique and Unusual Security Products, Surveillance, Micro Video and Countermeasure Items.
ORDER TODAY!
 "Jesus is Lord"
 813-653-9568 or send \$44.95 (plus \$7.00 shipping & handling) to:
SPY Shop U.S.A.
 146 W. Robertson St. BRANDON, FL 33511

AFFORDABLE AMMO AT GUNSHOW PRICES

★COR-BON★FEDERAL
 ★WINCHESTER★REMINGTON
 ★HORNADY★PMC ELDORADO
 ★BLACK HILLS★9 x 18 MAKAROV
 ★TRACERS★AND MORE!
\$2.00 FOR COMPLETE CATALOG
BRISSON'S
 (313) 584-3577 Mon-Fri 10-6 ET
 24hr. FAX (313) 582-6242
 DEPT. | P.O. BOX 1595, DEARBORN, MI 48121

PHOTO I.D. CARD (50 States). Send photo, eye/hair color, height, weight, birthdate. \$15.00. MAXSELL, P.O. Box 23021, Ft. Lauderdale, FL 33307. (213)

PASSPORT establishes 2nd identity for international safe travel. Embossed, entry/exit stamps plus more. Ultimate credibility worldwide. Positive client testimonials. Quintessential quality. (305) 568-1480 (24 Hrs) (213)

RUSSIAN LADIES, truly beautiful, educated, want to meet YOU. Free color photo brochure. RUSSIA46, P.O. Box 888851, Atlanta, GA 30356; (404) 458-0909. (217)

IRISH PRIDE BERETS, Black or Green Beret with Brass Irish Harp Crest St. PATRICK'S DAY SPECIAL \$23.00. A.H.A., Box 21606, Denver, CO 80221. (210)

NEW IDENTITY! Everything included to completely change identity. Driver's License, Social Security, Birth Certificate, Identification Card, Complete Instruction Booklet. Send \$29.95 to "CAS", P.O.Box 2392, Redondo Beach, CA 90278. (210)

BEAUTIFUL MEXICAN WOMEN seek romance! Free photos, full information. LATINS, Box 1716(TN), Chula Vista, CA 91912. (619) 425-1867. (210)

YOUR FBI, CIA, IRS RECORDS & more! \$49.95 plus \$6 shipping plus name, SSN, birthdate & place: BLUETREE, Box 4177FX, Mountainview, CA 94040. (210)

MEET BEAUTIFUL ASIAN COEDS through correspondence. For free photo brochure write to: The Phil-Am Connections, 366 N. Allen Avenue, Suite 331-F, Pasadena, CA 91106. (210)

SEXY ORIENTAL BABES want older men for romance and marriage. 250 girl video \$16.95. Photocatalog \$2. VOYAGE, 41 Sutter, #1309-R, San Francisco, CA 94104. (210)

CRAPS! Learn to win consistently with amazing new system. References furnished. Satisfaction guaranteed! Call toll free for recorded details. 1-800-217-7711. (211)

GLOBAL INTRODUCTIONS has the most unique concept ever devised for bringing single American and Canadian men together with beautiful Filipinas. Call (813) 576-2629. (218)

FREE! BACKSTAGE PASSES (Rock Concerts, Sports Events, Theatre) much more! Complete Guide \$20.00 Moneyback Guarantee. Maxsell POB 23021 FL. Laud. FL 33307. (215)

BEAUTIFUL RUSSIAN LADIES Educated & marriage minded. Catalog/live video interviews/tours "How to Guide" by pioneer company "Russian Connection" Contact: Correspondence International/Russian Connection 1850 Union St., Suite 1094SF, San Francisco, CA. 94123 (415) 994-4102, 24 hours. (210)

"LABORATORY" Glassware, Chemicals. Catalog \$2.00. Southern Oregon Scientific, 2001 Foothill Blvd. #E12, Grants Pass. OR 97526. (210)

LIGHT TUBES! Make your own! Sealed plastic tubes store until needed. \$5.00 cash/m.o. POWDERKEG PRESS, PO Box 555, Willis, TX 77378. (210)

AFRICAN PROTECTION/INVESTIGATIONS: "Close Protection Incorporated," a well established legitimate South African Based Organization. We supply Highly Professional Bodyguards to visiting Dignitaries, Businessmen and Tourists. We conduct Local and International Investigations up to corporate level. Our confidentiality and our professionalism is our ultimate advertisement. To contact our offices phone C.P.I. Johannesburg South Africa, Country Access Code +27 113914467/8 Fax +27 113914143 24 hour lines +27 824430482/ +27 836750944. (210)

BIG BROTHER KNOWS ALL. Order your FBI, CIA, IRS, DoD records, more. \$39 plus \$4.95 shipping. Include name, birthdate, birthplace, SSN: INFOMEDIA, Suite 376F, 2020 Pennsylvania Avenue, Washington, DC 20006. (212)

PHOTO ID CARDS

Drivers Licenses
Social Security Cards
Birth Certificates

MILITARY CERTIFICATES

Martial Arts Diplomas
Law Enforcement Certificates
College Degrees

CALL NOW **Free** 24
TOLL FREE **Brochure** HOURS
(800) 354-7555

Miller Publishing Co., Dept. SOF
7850 White L n., E330
BKFLD, CA 93309

REGIMENTAL INSIGNIA & WEAPONRY



• SAS • RAF • BLACK WATCH
• PARA • AM • CAMELONS
• ASDG • AN • GUARDS etc.

Import Catalog \$6.00

BRITISH REGALIA IMPORTS
Department-6

P.O. Box 50473 • Nashville, TN 37205

COLLECTOR'S EDITION — Extending the olive branch to our former adversaries, *Soldier of Fortune* presents its **FIRST** Russian issue of *Soldier of Fortune* magazine. Direct from Moscow, this unique publication — printed in Cyrillic — is a bona fide collector's item, sure-fire conversation starter, and an impressive addition to any coffee table around. Each copy comes with a numbered certificate, notarized and signed by *SOF* Publisher Robert K. Brown as to its authenticity. Less than 600 copies are in circulation outside the former Soviet Union. One can be **YOURS** for **ONLY \$20**. Offer good while in stock. Supplies are limited. Send check or MC/Visa number to: *SOF* Russian Edition, P.O. Box 693, Boulder, CO 80306.

FELLOW VETERANS REDUCE Your Electric Power Bills Substantially Guaranteed. Send SASE to Savings P.O. Box 818 Walkertown, NC 27051. (210)

FILIPINO INTRODUCTIONS, Computerized and video introductions to beautiful, traditional, Filipino ladies; seeking romance and marriage. Guaranteed Results! 2421 Pratt #623, Chicago IL 60645, 901-371-4384. (212)

OPTICS

INFRARED NIGHT VIEWER PLANS, build your own with complete plans and instructions. Send \$8 to, Infratech SF Box 1660 Southampton, PA 18966. (210)

REMAILING SERVICES

CONFIDENTIAL ADDRESS. Mail received here, then forwarded to you worldwide. Voicemail, too! MAILPOST, 2421 SOF Pratt, Chicago, IL 60645 (312) 764-0100, (800) 890-3199. (211)

SURPLUS

MILITARY CLOTHING, Gear, Boots, Jackets, Collectibles, etc. Call (408) 295-1136 or Fax (408) 288-6350 for **FREE** catalog or write: LEE-JACKSON MILITARIA, P.O. Box 8663, San Jose, CA 95155. Foreign catalogs are \$4.00. (212)

MILITARY SURPLUS & Survival Items; Large inventory, new and used. Mail \$1. (refundable) for price list: HUGH WADE'S, 2120 West Reelfoot Ave., Union City, TN 38261-9732. (211)

MILITARY SURPLUS. New and used, also survival items. Send \$2 for catalog. REMA MILITARY SURPLUS, P.O. Box 7039, Canton, OH 44705. (210)

BUGGED??

EAVESDROPPING is unbelievably widespread! Electronic Devices with amazing capabilities can be monitoring your telephone and room conversations **RIGHT NOW!** Are you sure you're safe? **FREE CATALOG tells you fast!** Includes Free Bonus details on fantastic opportunities now open in Counter-Surveillance field. Exciting, immensely interesting and **EXTREMELY** profitable (up to \$250 hr) full/part-time income. Call Now! **1-800-732-5000**

BEAUTIFUL RUSSIAN LADIES!



All still living overseas want to correspond with men of all ages for friendship, romance, and marriage. Many blue and green eyed **BLONDES, BRUNETTES, and REDHEADS**. Free 36 page catalogue with 500 photos.

CLUB PRIMA®

1104 R. Thorpe Lane, Suite #110DD; San Marcos, Texas 78666-7127 (512) 396 • 5522 24 hrs.!!!

BEAMSHOT™ 2000

Laser Sight

FDA APPROVAL
PATENTED



Retail: **\$89.00**

Including:

*Laser Sight *Mount *Gun Case *Battery
1 year warranty

*Click Alignment System *Window Lens *Water Resistant

Please call the dealer near you or 800-520-8435

Quarton USA, LTD. CO.

7042 Alamo Downs Parkway, Suite 250.
San Antonio, Texas 78238-4518
Tel: (210)520-8430 Fax: (210)520-8433

RADAR RECEIVING SCREEN: gov. surplus, 6' diameter, camouflage green, unassembled on 5 pallets. Call for price: (401) 539-2197. (210)

SURVIVAL

SMOKE GENERATING DEVICES and a vast array of survival products. Write for 56-page 500 item catalogue. U.S.-\$3.00, Canada-\$5.00, Others-\$10.00. Signus, Box 33712-W62, Phoenix, AZ 85067-3712. (210)

WARNING RADIOACTIVE * Attention concerned employees, military personnel and survivalists! Radioactive Contamination Detector. Small like a pocket radio. Very sensitive. E.S.I., 2927 West Liberty Ave. Box 156 Dormont PA 15216. (210)

TRAINING

BOUNTY HUNTER TRAINING by professionals; on-site in Florida or at country-wide seminars. Details. NABEA, P.O. Box 1170, Tombstone, AZ 85638. 1-602-457-9360. (210)

CATALOG for special interests. Info that has never before been published by former SPECOP Personnel. Rush \$1.00 to: Absolute Services, Inc. 18215 Highway 99, Linnwood, WA 98037. (215)



TRUMARK®

225 Yard Range folding slingshot stores ammo in handle. Includes 70 rounds of 1/2" white Tracer® brand marbles, and extra band assembly. Postf. paid **\$15.00 total**



TRUMARK®

SNAPSHOT brand

Rubberband Gun shoots 6 shots in rapid-fire action. Long 12" barrel snaps bands up to 30 feet. Black plastic stock & rotating starwheel. Includes 12 powerbands. **\$12.95** postage pd. Send your check or money order to: Trumark 1835-SF 38 th St. Boulder, CO 80301

CREDIT CARD ORDERS : 1 800 878-6272

OUTDOOR CAREERS!

Home study. Train for careers in conservation, forestry, wildlife, parks, and more. **Free career literature: 800-223-4542.**

Name _____
Address _____
City _____ State _____ Zip _____

School of Conservation, Dept. NNE171
PCDI, 6065 Roswell Rd., Atlanta, GA 30328



TELEPHONE LISTENING DEVICE



Size 1cu. in.

Record telephone conversations in your office or home. Connects between any cassette or tape recorder and your telephone line. Starts automatically when phone is answered. Records both sides of conversation. Stops recorder when phone is hung up.

\$19.95 EACH City Disc Avail



Super Powerful FM TRANSMITTER

Many times more powerful than other transmitters. Transmits up to 1/4 mile to any FM radio - Easy to Assemble Kit - up to 9V battery (not incl.) For catalog of Transmitters, Voice Scramblers and other specialty items, enclose \$2.00 to USI Corp

Call 407-725-1000 or send \$19.95 + \$1.00 shipping per item to: USI Corp, P.O. Box SF-2052, Melbourne, FL 32902 GOD'S OK

ISRAEL MILITARY PRODUCTS



AIRBORNE T-SHIRT S-XXI \$11+\$3 POST
IDF WEBBING, HELMET, INSIGNIAS, UNIFORMS, T-SHIRTS
CATALOG \$2 (FREE WITH T-SHIRT ORDER)
IMP P.O.B. 31006, TEL AVIV 61310, ISRAEL

NAVY SEAL FITNESS Program. Gain strength and self-confidence. Get in shape using the methods of the world's most elite combat unit. Send \$10.95 to: T-N-S ENT, P.O. Box 16297, Seattle, WA 98116. (214)

TRAVEL

R & R FOR SINGLE MEN. Dream vacation with beautiful, playful Filipinas, as featured on "Inside Edition". Big Apple Oriental Tours (SOF), 24912 Elkmont Avenue, Bellerose, NY 11426. (210)

BACHELORS BANGKOK TOUR - steamy nightlife, great marriage possibilities. Also pen pal, Asian videos, guide books, etc. Brochure 1-800-669-7020. (211)

SOLID BRASS PAPER WEIGHTS
 Made from 1/2 lb of solid brass. Polished to a smooth finish
\$12.95 Each or 2 for \$22.50
 Send check or money order plus \$4.00 Shipping & Handling to
Bud K World Wide MC or VISA call
 P.O. Box 565 Dept SF 1-800-543-5061
 Moultrie, GA 31776

U.S. GOVERNMENT LAND
 Federally owned land currently available in AK, AZ, AR, CA, CO, ID, MT, NV, NM, OR, UT, WA, WY for **\$2.50 per acre**. U.S. citizens entitled to purchase **up to 160 acres per person**. For complete information package including maps, telephone helpline, filing forms, etc. send \$20 check or money order to: **FEDERAL LAND CO., Dept L, Box 21598, Washington, DC 20009**. (Note: this is not homesteading—lands are sold outright.) **MONEYBACK GUARANTEE!**

Russian Ladies, truly beautiful, want to meet you!
 260 Beautiful, Educated Russian Ladies are sincerely seeking friendship and marriage with American men of all ages. We have selected these ladies from over 4800 applicants.
FREE Color Photo Brochure
RUSSIAN CONNECTION
 Dept. 100 • P.O. Box 888851 • Atlanta, GA 30356
 (404) 458-0909 (24 hours)
EXCITING MOSCOW TOURS AVAILABLE

HAT PINS - PATCHES - FLAGS
1500+ MILITARY DESIGNS
 FREE 24 Page ILLUS. CATALOG
 WE DO CUSTOM WORK
 Dealer Inquiries Welcome
HOOVER'S MFG. CO.
 401 55F PROGRESS BLVD.
 PERU, IL 61354
 (815) 223-1159, Ask For David

PROFESSIONAL PHOTO IDENTIFICATION
TIRED OF I.D. CARD KITS!
 WE MAKE THE FINEST 100% COMPLETE CREDIT CARD STYLE I.D. CARDS. YOUR PHOTO IS PERMANENTLY TRANSFERRED TO THE CARD. ALL NAMES AND DATA ARE EMBOSSED
 SEND \$2 FOR BROCHURE (SPECIFY ID CARD)
SAFEGUARD I.D. SERVICES
 P.O. Box 689-FI Ely, NV 89301
 (702) 289-4229

Telephone Listening & Recording Devices
MA-100 Devices Hidden In Dual Modular Adapters! **DMR-20** FM Transmitter
 Crystal clear reception on FM radio up to 1/4 mile
 SnapKit uses phone line for power & antenna
DMR-20
 Starts & stops recorder when phone is used
 Plugs into standard cassette recorder
 Works when any phone in house is used
\$25.95 (free shipping) Visa/MC (214) 255-7490 **\$29.95**
 Seymour-Radix Inc. Box 166055 - SF Irving, TX 75016

Gunvertor® Universal T.V. Remote
\$39.88
 Trigger changes channels on your T.V., VCR, cable box or a 2nd T.V. Works on all brands. **Satisfaction Guaranteed!**
 Free color catalog of adventure gear with your Gunvertor® order. Credit Card Orders 1-800-777-7732. Product 8769SFGU.
U.S. CAVALRY

WE SPECIALIZE IN CUSTOMIZED tours to Thailand, Philippines. Give us a try! Free information. POA Ltd. 1738 Orleans Rd. Harwich, MA 02645-1541. (210)

SOVIET MILITARIA
 Soviet Military Medals, Orders, Police Badges, Uniforms, Field Gear, Insignia and All Related Items. 
 Special Orders Welcome. Send \$1.00 for catalog to: **The Russian Trade House**
 Dept. 121, P.O. Box 2585
 Fairfax, VA 22031
 Fax: 703-978-4885

THE SPOOK BOOK
 A Strange and Bizarre Look at Forbidden Technology
 Mick Tyrner
 The book that blew the lid off Forbidden Technology! Building Teflon-coated bullets, re-arming inert grenades, secrets of titanium warheads, hyper-secure encryption, rocket weapons, clandestine pyro exposé, wearing a wire, defeating alarms, forbidden tech marketplace, surveillance photography, computer viruses, scrambling/descrambling, ultrasonic weapons, much more! 8.5x11, 258 meaty pages, a fresh & lucid look at Forbidden Technology! \$33 domestic postage paid. Registry Distributing, 200 Union Blvd, Suite 430, Denver, CO, 80228. Sold only to inform.

WORLD'S BEST KEPT SECRET!
 According to IRS code, the United States Constitution, and documented Supreme Court rulings... you can **STOP PAYING INCOME TAXES LEGALLY!!** For information send **\$3.50 to:** Art Martin, 6425 Lawrenceville Hwy, Suite I Box 190, Tucker GA. 30084

VIDEOS
"WORSE THAN TAILHOOK", screamed "American Journal" about "lewdness and debauchery" outside our former Philippines bases. We offer full-length, uncensored videos of these actual parties. For catalog, send \$3 to: B.A.O. Videos (SOF), 47 Raymond Avenue, Poughkeepsie, NY 12603. (210)

WANTED
WANTED PROFESSIONAL BODYGUARDS & Investigators: Join the foremost international Networking Team available. Seasoned, experienced, newly initiated! Develop your opportunities through learning and contacts. High Demand and Rewards! Send \$10.00 for infopak to: BASECA, 383 Ridge Road, Newton, NJ 07860. (213)

ADVERTISERS INDEX

AMC Sales	85	Milarm	78	David Steele Ent Inc.	91
AMT	68	Moore Technical Industries	66	Dewey Research Center	90
Automatic Knife Resource Guide	70	National ID Center	83	Eden Press	88
Benchmade Knife Company	74	Olympic Arms	86	First Witness Video	91
Blaylock's Gun Works	92	Optimum Training Systems	21-24	Global School Of Investigation	90
Carolina Ordnance	Cover 3	Paladin Press	7, 26-27	Greene Military	89
Cause Foundation	68	Quality Machining Inc.	77	Gun Parts Corporation	89
Collector's Armoury	72	SOF Convention	31	Hitek	90
Cop Stk	79	SOF Russian Edition	85	Hurricane International	91
Crown Specialty	14	SOF Sweepstakes	18	JTR Labs	89
Delta Press	76	SOF Three Gun Match	84	LA Law Enforcers	91
Doubleday Military Book Club	10-11	S.T.A.N.O.	8	Lile Handmade Knives	88
Eagle Arms	80	Safari Press	76	M.O.R.O. International	89
Eagle Industries Unlimited	19	Scattergun Technologies	70	Matthews Police Supply	88
Edge Company	29	Self Defense Supply	65	Outlaw Skydiving Team	90
Elite Forces	29	Shooting Systems Group	87	Politically Incorrect Graphics	91
Excalibur Enterprises	20	Southern Ordnance	69	Professional Career Development	88, 90
G-Jo Institute	87	Steve Arnold's Gunroom	67	S & K Products	88, 92
H-S Precision	70	Sturm, Ruger & Co.	Cover 4	Silvermans	91
Hollywood Engineering	84	Sunset Cliffs Merchandising	86	Special Operations Group	90
Intelligence Incorporated	9	Sun Pure	71	U.S. Cavalry	89
Israeli Sky Connection	73	U.S. General Technology	Cover 2	USI Corporation	88
JR Customs	82	United Pacific Freight	29	Westbury Sales Co.	92
JTR Labs	15	Universal Trading	15	WW2 Products	88
K.A.O.S. Kutlery	81	Wild Things	85		
KG Products	80				
Lifefinder	75	SUPPLY LOCKER			
Machine Gun News	81	BTN Publishing	89	ADVERTISING POLICY: Publication of any advertisement in Soldier Of Fortune Magazine is not an endorsement of the advertiser of the product(s) or service(s) advertised, either by SOF Magazine or by the Editor and Publisher.	
Marketing Excellence	13	California Residents	92		
Michaels Of Oregon	77	Cutlery Shoppe	89		
Michigan Body Armor	85	Cutting Edge Enterprise	90		

CAROLINA ORDNANCE

**HIGH
CAPACITY
MAGAZINES**

**37MM LAUNCHERS TACTICAL
KNIVES**

THESE ARE GENUINE "THERMOLD" MILITARY SPEC. MAGS, AS USED BY THE CANADIAN MILITARY, AND ARMED FORCES AROUND THE WORLD. "THERMOLD" MAGAZINES ARE MADE FROM DUPONT "ZYTEL", A COMPOSITION OF FIBERGLASS AND POLYMER MORE DURABLE AND CONSIDERABLY LIGHTER IN WEIGHT THAN METAL WITH THE CURRENT POLITICAL SITUATION AND "BANS" THAT HAVE BEEN ENACTED THE MAGS YOU PROCURE NOW, MAY HAVE TO LAST A LIFETIME, AND "THERMOLD MAGS WILL !! OUR HIGH CAPACITY MAGS ARE AVAILABLE (WHILE THEY LAST) FOR THE FOLLOWING WEAPONS:
STANDARD MAGAZINES;

AR15/M16 20RD. ALL STANDARD MAGS ARE
AR15/M16 30RD. SALE PRICED AT \$15.00EA
M14/M1A 20RD. OR 10 FOR \$130.00
H&K41/91 20RD.



EXTENDED CAPACITY (STORAGE) MAGS, THESE MAGS CAN HOLD EITHER 28 OR 30 RDS. INDEFINITELY, WITHOUT DAMAGING THE SPRING, THEN, WHEN NEEDED, YOU COMPRESS THE SPRING AND HAVE YOUR LOADED MAG READY TO FEED AND FUNCTION PERFECTLY. STORAGE MAGS CAN ALSO HOLD 45 RDS. (WHEN EXTENDED) FOR ADDITIONAL FIREPOWER. STORAGE MAGS ARE AWE AVAILABLE FOR THE FOLLOWING WEAPONS:

AR15/M16 30/45 ALL STORAGE MAGS ARE
AR180 30/45 SALE PRICED AT \$25.00EA.
RUGER MIN30 28/45 OR 10 FOR \$230.00

WE ALSO HAVE A LIMITED SUPPLY OF EAST GERMAN 30 ROUND AK47 MAGS. THESE ARE NEW IN WRAPPERS AND OF EXCELLENT QUALITY. SPECIAL PRICES ARE \$12.00EA. OR 10 FOR \$99.00

**CAROLINA
GIRLS**

**2-18"X24" POSTERS
BOTH FOR \$5.00+\$2.00S&H**



OUR SIX SHOT 37MM LAUNCHER FOR: FLARES, SMOKE, GAS, AND DIVERSIONARY DEVICES. AS SEEN IN THE LATEST ACTION MOVIES. HANDLES UP TO 5" PROJECTILES, AUTO INDEXING FEATURE ALLOWS FIRING 6RDS. IN 3.5 SECONDS!! \$1495.00

UNDER-BARREL LAUNCHER AS USED WITH AR15 [CAN BE ADAPTED TO OTHER WEAPONS] USES ALL STD. 37MM RDS. SALE PRICE \$199.00

STANDARD HAND HELD 37M/M LAUNCHER SHOOTS ALL STANDARD PROJECTILES, SINGLE RD. CAPACITY, OPTIONAL TRIP WIRE TRIGGER AVAILABLE. SALE PRICED AT \$50.00



PICTURED ABOVE IS THE "WHITE WOLF" DROP POINT AUTOMATIC FOLDER, MEASURING JUST UNDER 5" CLOSED AND SLIGHTLY OVER 8.5" OPEN, THIS IS A HIGH QUALITY, HAND-CRAFTED, PRECISION WEAPON AT \$199.00 [SHEATH INCLUDED].



THE KNIFE ABOVE IS A CLASSIC COMPACT AUTOMATIC 'TANTO' FROM "WHITE WOLF" MEASURING 4 1/8" CLOSED, 7" OPEN, AND LESS THAN 1/2" THICK. THIS IS A HAND-CRAFTED WEAPON YOU WILL BE PROUD TO OWN. PRICED AT \$225.00 [SHEATH INCLUDED]

37M/M AMMO

37M/M FLASH BANG "WILDLIFE CONTROL" ROUND, [100YD. RANGE] @\$18. EA. OR 10 FOR \$150.

37M/M 100% [NOT WIMPY 10%] OC AIRBURST PEPPER GAS @\$40. EA. OR 10 FOR \$350.

37M/M SMOKE [60 SECOND] AVAILABLE IN RED, GREEN, YELLOW, OR BLUE @\$8.00EA. OR 10 FOR \$60.

12GA. FLASH BANG "BIRD CONTROL" @\$1.00EA. OR \$15.00 BOX OF 25 40YD. RANGE EXTRA LOUD!!!

**CAROLINA ORDNANCE
1985 TATE BLVD. SE # 614
HICKORY N.C. 28602
ORDER LINE 800-477-9380**

**CALL 7 DAYS
A WEEK**

**24 HOURS
A DAY**

[704]345-1567

FAX [704]345-1836



**NO POSTAGE
NECESSARY
IF MAILED
IN THE
UNITED STATES**

BUSINESS REPLY MAIL
FIRST CLASS MAIL PERMIT NO. 8 MT. MORRIS, IL

POSTAGE WILL BE PAID BY ADDRESSEE

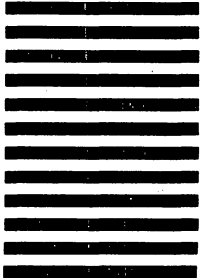

**SOLDIER OF
FORTUNE**
PO BOX 348
MT MORRIS IL 61054-9817



From .416 to .22 LR WE'VE GOT IT ALL!



- 26 Models
- 290 Variations
- 42 Calibers
- 3 Gauges
- 25 Barrel Lengths
- 19 Stock Variations
- 16 Grip Variations

Photo:

Top to Bottom:

Long Guns:

1. New 20ga. Sporting Clays
2. All weather S.S. MKII .270
3. Ruger #1 .243
4. Mini 14 Ranch Rifle .223

Left to Right:

Handguns:

1. New P94 9mm
2. GP100 4" .357mag.
3. New Black Powder Fixed Sight
4. New VAQUERO .45 Colt



RUGER®

Arms Makers for Responsible Citizens