

**EXCLUSIVE: Clinton's Covert Gun Control**

# SOLDIER OF FORTUNE

**WIN AN  
ASTRA  
A-75 9mm  
— See  
Page 66**

**HIGH NOON  
IN HAITI**

**RUSSIAN BULLETS  
FOR BLACK OPS**

**H&K's ULTRA-SECRET  
MYSTERY RIFLE**

**OPERATION  
LEATHERNECK:  
Running Guns  
Out Of Vietnam**

**LITTLE BIG GUN  
AMT's Definitive  
Big Bore Back Up**

**YSTERGARDE —  
Inside S. Africa's  
Right Wing  
Special Forces**

JANUARY 1995  
# 48493



CAN. \$4.75 • UK £2.60 • U.S. \$3.95

SOF 20th Anniversary



# GREAT GUNS GIVEAWAY!

Celebrate all  
year long -



**GREAT  
PRIZES!\***  
**GREAT SAVINGS  
ON SOF ONLY**  
**\$26.20**

\*no purchase necessary to win  
credit card orders call  
1-800-877-5207

- 1 year @ \$26.20  
 2 year @ \$50.00  
 sweepstakes only  
 bill me later

name \_\_\_\_\_

address \_\_\_\_\_

city \_\_\_\_\_

state \_\_\_\_\_ zip \_\_\_\_\_

day phone # \_\_\_\_\_

Offer good in the U.S. and possessions including APO, FPO addresses, for a limited time only. Canada add \$10.00 per year.  
(includes GST #R128476249) foreign add \$21.00/yr. Money Back Guarantee

# NIGHT VISION

**Best Warranty In The Business!**

INCLUDES  
SOFT CASE



**RETRON-M01**  
Gen I, latest technology

INCLUDES SOFT  
OR HARD CASE



**B-12/453/336 STARLIGHT**  
Gen I, 2.5-3.2x Interactive ICT

INCLUDES HARD CASE  
AND RIFLE MOUNT



**B-5P STARLIGHT**  
Gen II Rifle Scope

INCLUDES SOFT CASE



**OH2**  
Gen I, Hands-free Operation

INCLUDES  
SOFT CASE



**B6 STARLIGHT**  
Gen II Panoramic Viewer

INCLUDES SOFT OR  
LEATHER CASE



**PNV NIGHT HAWK**  
Gen I, 2.5x Compact Binoculars

INCLUDES SOFT  
CASE AND  
RIFLE MOUNT



**NS2-AC**  
Gen II, Day and Night Use

INCLUDES  
METAL CASE



**PNV-57E STARLIGHT**  
Gen I, Wide-angle Goggles

- Finest single source of daytime & Night Vision products for every application
- IST 2ND & 3RD Generation Night Vision products
- Major Credit Cards Accepted
- 2-Year limited warranty - ALL PRODUCTS

## You Can Own A Piece Of History!

Available now for the first time in the United States, the original Russian-made sniper rifle...



Federal Firearms License Required for all gun purchases.

1000 LIMITED EDITION... RESERVE YOUR GUNS TODAY!

Unlike the Chinese or Romanian imitations which you may have seen other importers advertising as "Soviet-style", these 1000 original limited edition sniper rifles were developed by the Dragunov team and manufactured in Russia.

Select Dealers — Don't miss your chance to add one of the industry's most sought after rifles to your inventory.

Get in on the finest firearms purchase in history!

This is the rifle your customers have been waiting to own!



Mr. Dragunov

Mr. Dragunov, revered as Russia's master gunsmith, left his legacy in his life's work to only a chosen few. The authentic Dragunov rifle, considered to be one of the finest sniper rifles engineered in this century, was only available to the Soviet military and selected Eastern Block forces. His vision was that every serious sportsman and shooter might experience the capabilities of this unique firearm. That dream is now a reality with this historic buying opportunity now being presented to you.



**U.S. General Technologies, Inc.**

145 Mitchell Avenue • South San Francisco, CA 94080

Orders: 800-BUY-USGT (289-8748) • Info: 415-634-8440 • 24-hr Fax: 415-634-8452

# COMMAND GUIDANCE

## MAGAZINE STAFF

**Editor/Publisher** ..... Robert K. Brown  
**Associate Publisher** ..... T. (Lefty) Wilson  
**Executive Editor** ..... Tom Slizewski  
**Senior Editor** ..... Don McLean  
**Technical Editor** ..... Peter G. Kokalis  
**Features Editor** ..... Dwight Swift  
**Columns Editor** ..... Lynne Robertson  
**Production Director** ..... Kathleen Allard  
**Art Director** ..... Mary Scrimgeour Jenkins  
**Assistant Art Director** ..... Kristine Anderson  
**Special Projects** ..... Alexander McColl

## Foreign Correspondents

**Chief Foreign Correspondent:** Dr. Tom Marks  
**Senior Foreign Correspondents:**  
Steve Salisbury • Rob Krott • Peter Douglas •  
Chuck Fremont • Morgan Tanner •  
Jack Thompson • Maj. Mike Williams •  
Mike Winchester • Dale B. Cooper

## Contributing Editors

*Vietnam Veterans Affairs* Col. Chuck Allen •  
*Military History* William Brooks — William H. Northacker • *Unconventional Operations* Brig. Gen. Heine Aderholt — James P. Monaghan — Maj. Robert MacKenzie • *Paramedic Operations* Dr. John Peters • *Explosives/Demolitions* John Donovan • *Aviation* Dana Drenkowski • *Africa* Al Venter • *Outdoor Affairs* Galen Geer • *Latin America* Hugo Hartenstein • *Gun Rights* Paul Danish • *Skydiving* Kitty Baran

**Financial Director** ..... Gregg Peterson  
**Business Manager** ..... Sharon Windsor  
**Bookkeeper** ..... Carole Hayden  
**Circulation Manager** ..... Carrie Karlson  
**Consultant** ..... Zada Johnson  
**Advertising Manager/Assistant**  
**Convention Director** ..... Dianne McLeod  
**Receptionist** ..... Helena Oberg

For editorial/advertising, call 303-449-3750.  
Subscription inquiries, call 1-800-877-5207.  
For list rental contact: Dave Power, Antigone Associates 215-357-9267.

## In Memoriam

Craig Nunn — Art Director  
Lance Motley — Foreign Correspondent  
Barry Sadler — Contributing Editor

NOTICE: SOLDIER OF FORTUNE Magazine is a magazine of national and international distribution. There may be products in the magazine of which sale, possession or interstate transportation may be restricted, prohibited or subject to special licensing requirements in your state. Purchasers should consult local law enforcement authorities in their area. All data in this publication, technical or otherwise, is based upon personal experience or individuals using specific tools, products, equipment and components under particular conditions and circumstances, some of which may not be reported in the article and which Soldier Of Fortune has not otherwise verified. Soldier Of Fortune, its agents, officers and employees disclaim any responsibility for all liability, injuries or damages.

## Law Enforcement Alliance of America

by Robert K. Brown

One of the major problems, if not *the* major problem that the NRA specifically, and the pro-gun lobby in general, has in the fight for our Second Amendment is the loss of police support for the right of the individual to keep and bear arms. And by "police" I mean, in general, the administrators and police officials who are subject to political pressures — not the average street cops.

This problem began sometime after the anti-gun Proposition 15 was soundly defeated in California — with the help of the vast majority of state law enforcement agencies. The anti-gunnies, though misled and insidious, are not stupid. They did an after-action analysis of their defeat and decided if they were to successfully push their agenda, they would have to win law enforcement over to their point of view. This they did over a period of years to the extent that virtually all major law enforcement organizations, such as the Fraternal Order of Police (FOP) and the International Association of Chiefs of Police (IACP) became the "running dogs" of the anti-gun lobby.

Unfortunately, for a number of years the NRA failed to see this threat, and for reasons too long to go into in this short space, failed to

counterattack. We have seen the disastrous results.

However, a relatively new organization, the Law Enforcement Alliance of America (LEAA), which is pro-gun and anti-crime, has taken up the lance to joust with the anti-gun FOP and IACP fascist swine. Its membership has grown to more than 40,000 working law-enforcement officers and crime victims. And they have been effective. However, they need every one of us to join to increase their prestige, clout and their resources so they can fight even harder.

As I write this a few days before the election, we are closely working with LEAA to "educate" the voters in turncoat Tom Foley's district. I'll have more info on our efforts in the next issue.

In the meantime, for more information on LEAA and how you can join for only \$20 a year, call or write:

Law Enforcement Alliance  
of America  
7700 Leesburg Pike,  
Suite 421  
Falls Church, VA 22043  
(800) 766-8578 or  
(703) 847-2677 ✕



SOLDIER OF FORTUNE (USPS 525-810, ISSN 0145-6784) is published monthly by SOLDIER OF FORTUNE Inc., 5735 Arapahoe Ave., Boulder CO 80303-1340. Second-Class Postage is paid at Boulder CO and additional mailing offices. POSTMASTER: Send address changes to SOLDIER OF FORTUNE, Subscription Department, POB 348, MT Morris IL 61054-0348 or call 1-800-877-5207. U.S. and APO-FPO subscription rate for twelve monthly issues: \$28.00. Canada add \$10.00/yr. additional postage (includes GST tax registration number: R128476249). All other countries add \$21.00 U.S. FUNDS ONLY. Single Issue Price — U.S., \$3.95; United Kingdom, £2.60; Canada, \$4.75. PRINTED IN THE U.S.A.

CONTRIBUTORS: Manuscripts, photographs or drawings are submitted at the contributor's own risk. Material should be mailed to Articles Editor, SOLDIER OF FORTUNE, P.O. Box 693, Boulder, CO 80306, and cannot be returned unless accompanied by sufficient postage. Any material accepted is subject to such revision as is necessary to meet the editorial requirements of SOF. All manuscripts must be typed double-spaced. All photographs should be credited and be accurately identified. Payment will be made at rates current at time of publication. Editorial office phone number is 303-449-3750.

Copyright © 1995 by SOLDIER OF FORTUNE Magazine Inc. All Rights Reserved.



Ystergarde — page 44

Photo: Anthony C. LoBaido

## FEATURES

### **SOF T&E: SEAL'S ATTACK PACK** Peter G. Kokalis

Equally at home with a pair of skis or an M16A2 M4 Carbine strapped to its side, this ruck fills the bill for day hikes or special ops. 31

### **HIGH NOON IN HAITI** Dale B. Cooper

With Cedras under the gun in Haiti, Clinton pulls his "All American" punch in midair and opts for a kinder, gentler invasion — with mixed results. 32

### **CLINTON'S COVERT GUN CONTROL** SOF Staff

King William defies the Constitution and public opinion and bans certain guns by royal decree. 36

### **GEER ON GEAR**

**Galen Geer**  
Outdoor affairs editor concludes his review of equipment that passed muster in Africa and the United States. 38

### **BLACK BULLETS FOR BLACK OPS** SOF Staff

Collapse of the Soviet Union may have signalled the death of the Soviet empire, but not its covert suppressed-ammo industry. 40

### **YSTERGARDE**

**Anthony C. LoBaido**  
SOF penetrates the shadowy world of South Africa's Afrikaner resistance movement and finds the Boer religious right a bastion against the New World Order. 44



High Noon — page 32

Photo: Dale B. Cooper

**Command Guidance** 3

**Bulletin Board** 6  
Guns For Therapy

**I Was There** 12  
Trial By Fire

**World SitRep** 16

**Combat Weaponcraft** 18  
Two Hits Per Customer

**Slick Willie Watch** 23  
Commies In Our Midsts

**FLAK** 27  
Better Dead Than Disarmed

**Advertisers Index** 67

**Supply Locker** 71

**Classified** 77

**Parting Shot** 82  
Securing A Free State



Operation Leatherneck — page 54

Photo: Will Cadence

## HECKLER & KOCH'S MYSTERY RIFLE

**Nick Steadman**

H&K reinvents the wheel with elusive HK50 in a race with Steyr for new NATO compatible G36/MG36 contract. 48

## LITTLE BIG GUN

**Peter G. Kokalis**

Small, powerful and reliable, AMT's tiny terminator in .45 ACP may be just the pick for those who pack a pair. 50

## OPERATION LEATHERNECK

**James L. Pate**

Undercover U.S. Customs agent finds an explosive mix of gunrunners, weapons dealers, corrupt Vietnamese, POW scams and dead bodies — while the Treasury Department hangs him out to dry. 54

## COVER

RTO with M16A2 guards Haitian army Cadillac-Gage V-150 during Operation Uphold Democracy — Clinton's bloodless invasion. Article detailing last-minute cancellation of largest airborne operation since World War II and subsequent Haitian violence begins on page 32. Photo: Peter Noble



# BULLETIN BOARD

## CLEAR AND PRESENT ERROR

We received incorrect caption information on the *Clear And Present Danger* feature in the October issue and misidentified Jaime Gomez as Ben Bratt on the cover and inside. We also received the following letter from Jared Chandler, one of the technical advisers on the film:

"The teaser in the contents column referred to me and Mr. Goyen as 'active duty SpecOps operators.' This is not correct. We were not on active duty, nor did we ever indicate to anyone that we were. Our work on this film, in accordance to Department of Defense guidelines, was as private consultants. Controversy was created by the statement in the teaser. I respect the SpecOps personnel who are doing

their jobs right now as you read this. Such a misrepresentation if done purposefully would be offensive.

"During the entire production of the film, I worked closely with the Army public affairs office in Los Angeles and the Directorate for Special Operations. The guidance I received was both strict and specific. Misrepresentations would greatly detract from the hard work invested in the making of the film."

## ONE WE WON

Retired school principal Virgil Cooper, 71, unseated eight-term anti-gun Rep. Mike Synar (D-Okla.) in a primary runoff last September. The winning Cooper told the press that the NRA, its members and Synar's advocacy of restrictive gun control made the crucial difference

in his victory. Tanya Metaska, executive director of the NRA's Institute for Legislative Action, noted that although NRA phone banking was instrumental in defeating Synar, it was individual Oklahoma NRA members who volunteered and campaigned that won the day.

The NRA also had a high profile in Synar's election bid two years ago, and when he won, Synar said gun owners had no political power. He was half-right: Gun owners have no political power if they don't quit preaching to the choir and don't get off their collective duffs and register, vote and campaign for pro-gun candidates. *When we do, we can win.*

## CONGRESSIONAL HEARINGS ON BATF CONDUCT

U.S. Rep. Jack Brooks (D-Tex) will be chairing congressional hearings to investigate the conduct of the Bureau of Alcohol, Tobacco and Firearms (BATF) this session of congress. Brooks has indicated he is concerned with the "anti-gun" bias of the BATF and their repeated violations of American gun-owners' constitutional rights.

It is vitally important

that concerned gun owners contact Brooks, as well as their own congressperson, to make known their strong support for these hearings: The Honorable Jack Brooks, United States Congress, 2449 Rayburn House Office Building, Washington, DC 20515-4309. The name and address of your own congressional representative is posted at your local post office (shame on you if you had to ask).

## MILITIA MAKERS

Remember Kennesaw, Georgia, the town that passed an ordinance requiring all households to have a gun? And the counties in Florida that formed militias? Here's a



Reader Lt. Marco Ruggiero of Italy's UNUCI Firenze takes a moment before a mountain patrol tournament near Rome to pose with his colleagues and SOF. Marco expressed hope we could publish the picture before lawyers run us out of business. Glad to! And lieutenant, feel free to send us a picture of your son in uniform when he grows up and we'll print that, too. The lawyers are gone and SOF is still right here, doing what we do best. Photo: courtesy of UNUCI Firenze



We didn't have room to run this in "Geer on Gear" (page 38), but will report back next issue, as SOF Editor/Publisher R.K. Brown fully intends to use this as his elk rig this year. The CV 9040 combat vehicle, made jointly by Bofors AB and Haggblunds Vehicle AB of Sweden, serves to get the crew to the hunting camp and engage tanks, hostile vehicles, choppers and furry ground targets. Photo: courtesy Bofors/Haggblunds Vehicle

## THE STONER MACHINE GUN

### A Navy SEAL Remembers

The legendary Stoner machine gun was the favorite heavy-firepower weapon of U.S. Navy SEAL Teams in the jungles of Vietnam. This action-packed video shows you everything you want to know about this remarkably effective but little-known weapons system. Lots of wild fully automatic shooting demonstrates the awesome power of the gun in action. Plenty of completely new footage of Stoners being used in Vietnam by SEAL commandos pays tribute to its effectiveness as a combat weapon. This authentic film includes SEALs in training and on patrol, plus a unique segment of a SEAL operational briefing prior to a mission. Throughout the film, a SEAL who used the Stoner extensively in Southeast Asia provides a detailed analysis of its features, quirks and combat capabilities. Anyone interested in the Stoner weapons system or historic machine guns, U.S. Navy SEALs or the Vietnam War is sure to be thrilled by the wealth of information in this one-of-a-kind video. Color, approx. 30 min., VHS only. **\$29.95**

**VIDEO**



**HOME WORKSHOP PROTOTYPE FIREARMS**  
How to Design, Build, and Sell Your Own Small Arms  
by *Bill Holmes*  
Master gun maker Bill Holmes shares what will and won't work in designing and building rifles and shotguns from raw materials. Includes the fine points of creating everything from actions to sights, as well as tips on tools, materials, assembly, finishing and more. For academic study only. 8 1/2 x 11, softcover, photos, illus., 192 pp. **\$25.00**



**EXECUTIVE PROTECTION**  
A Professional's Guide to Bodyguarding  
by *Benny Mares*  
Being a bodyguard is not all sunglasses, dark suits and muscle. This book debunks the myths and stereotypes and describes the realities of protecting celebrities, executives and foreign dignitaries. Executive protection specialist Benny Mares tells you how to get in on the ground floor of this expanding field. 5 1/2 x 8 1/2, softcover, 112 pp. **\$12.00**



**ULTIMATE SNIPER: THE VIDEO**  
with *John Plaster* & *Carlos Hathcock*  
Learn the art of sniping from two masters. Maj. John Plaster instructs you in all areas of sniping fieldcraft, marksmanship and tactics, and famed USMC sniper Carlos Hathcock recounts some of the field-tested tactics he used to rack up 93 confirmed kills in Vietnam. Covers optics, weapons, shooting drills, camo, stalking, hides, countersniping, range and wind estimation and more. Color, approx. 90 min., VHS only. **\$59.95**

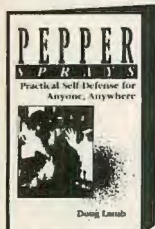

**PEPPER SPRAYS**  
Practical Self-Defense for Anyone, Anywhere  
by *Doug Lamb*  
They're the latest rage in self-protection: OC pepper sprays in every shape, size, strength and formulation imaginable. But are they really effective? And if so, why? How do you use them correctly - and safely? What's the best kind to buy? What features should you look for? This book has the answers. 5 1/2 x 8 1/2, softcover, photos, illus., 120 pp. **\$15.00**



**THE ULTIMATE SNIPER**  
An Advanced Training Manual for Military and Police Snipers  
by *Maj. John L. Plaster, USAR (Ret.)*  
This highly readable and extremely valuable training book covers the practical, field-tested details of sniping's three great skill areas - marksmanship, fieldcraft and tactics. Rifles, scopes, ballistics, target detection, stalking, hides, camo, countersniping, special ops, police vs. military and much more. 8 1/2 x 11, softcover, photos, illus. 464 pp. **\$39.95**



**THE LONG-RANGE WAR**  
Sniping in Vietnam  
by *Peter R. Senich*  
This is the most complete report ever on the U.S. military's unprecedented use of snipers and sniping equipment in Vietnam. Highlighted are the fielding of the XM21 sniper rifle and the Adjustable Ranging Telescope, plus the application of sound suppression devices and special carbines so typical of the unconventional warfare in SE Asia. 8 1/2 x 11, hardcover, photos, illus., 280 pp. **\$39.95**



**GET EVEN**  
The Complete Book of Dirty Tricks  
by *George Hayduke*  
A hilarious overview of the methods people use to get even with big business, government and enemies. These dirty tricks range from the simple to the elaborate, including more sophisticated schemes devised by CIA and Mafia members and political dirty tricksters. For entertainment only. 5 1/2 x 8 1/2, hardcover, 208 pp. **\$19.95**



**RED CELL**  
Secret SEAL "Terrorist" Operations  
Here is the controversial story of the U.S. Navy's top-secret SEAL commando unit tasked with testing security at U.S. and NATO bases worldwide. Now for the first time you can see the shocking footage taken by Red Cell during its raids, showing stunning evidence of security lapses that allowed them to breach fences and gates, plant bombs and take Americans hostage. Color, approx. 55 min., VHS only. **\$59.95**



**NAVY SEALs**  
The Men Behind the Legend  
This exciting video of all-new action footage features the most famous SEAL commanders of all time and their pivotal roles in the development of the Teams: Doug Fane and the first frogman; Roy Boehm and the guerrillas of Vietnam; Dick Marcinko and his elite counterterrorists; and Tom Katana and the ultramodern SEAL warriors of today. If you see one film on Navy SEALs, this should be it! Color, approx. 70 min., VHS only. **\$39.95**



**POLICE RIFLES**  
Selecting the Right Rifle for Street Patrol and Special Tactical Situations  
by *Richard Fairburn*  
Here is a complete guide to selecting and using the right patrol, military or sniper rifle for everyday and special law-enforcement situations. Fairburn analyzes the strengths of candidate weapons and their calibers. He also provides field tricks and proven drills that will maximize the officer's and rifle's performance. 8 1/2 x 11, softcover, photos, illus., 248 pp. **\$30.00**

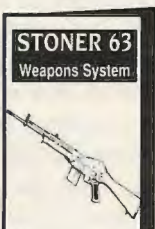

**STONER 63 WEAPONS SYSTEMS**  
This was one of Paladin's first weapons manuals. Always a favorite with readers, it is being reissued now because it still contains the most thorough and comprehensive information available on the one complete small-arms weapons system, the Stoner 63. Find out why the marines love this weapon so much and how the SEALs used it with devastating results in Vietnam. 8 1/2 x 11, softcover, photos, illus., 34 pp. **\$10.00**

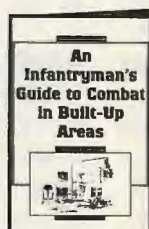

**AN INFANTRYMAN'S GUIDE TO COMBAT IN BUILT-UP AREAS**  
Foreword by *Col. Rex Applegate*  
This combat manual covers ground operations in urban settings. It clearly outlines skills unique to city fighting, including analyzing terrain, seizing blocks and buildings, setting up firing positions, scaling walls, employing snipers, evaluating civilian impact and effects of small arms and support weapons, and much more. 8 1/2 x 11, softcover, illus., 312 pp. **\$29.00**

## OTHER FASCINATING TITLES

New I.D. in America .....\$17.00  
JUST SAY NO TO DRUG TESTS .....\$12.00  
FUGITIVE: HOW TO RUN, HIDE, AND SURVIVE.....\$12.00  
HOW TO GET ANYTHING ON ANYBODY.....\$30.00  
U.S. NAVY SEAL COMBAT MANUAL .....\$19.95  
WILDERNESS WAYFINDING..\$15.00  
MODERN WEAPONS CACHING .....\$14.00  
CREDIT SECRETS: HOW TO ERASE BAD CREDIT.....\$14.00

SECRETS OF A SUPER HACKER.....\$19.95  
BOOK 2: HOW TO GET ANYTHING ON ANYBODY ..\$35.00  
CARLOS HATHCOCK: MARINE SNIPER (VIDEO) ..\$29.95  
KGB ALPHA TEAM TRAINING MANUAL .....\$20.00  
HOME WORKSHOP GUNS I: THE SUBMACHINE GUN....\$15.00  
HOME WORKSHOP GUNS II: THE HANDGUN.....\$14.00  
100 GREATEST COMBAT PISTOLS .....\$40.00  
SKINHEAD STREET GANGS . \$20.00

**MONEY-BACK GUARANTEE — DEALER INQUIRIES INVITED**  
Paladin Press • P.O. Box 1307 • Boulder, CO 80306 • (303)443-7250  
FAX (303)442-8741  
*Videotapes are nonreturnable. Damaged tapes will be replaced.*



**PALADIN PRESS**  
P.O. BOX 1307-5AS  
BOULDER, CO 80306



**CREDIT CARD ORDERS CALL TOLL FREE**  
1-800-392-2400  
Call 24 hours a day, 7 days a week. Send \$2.00 for a 64-page CATALOG of over 600 titles (free with order).

PLEASE SEND ME THE FOLLOWING TITLES:

RESPONSE CODE: 5AS

NAME \_\_\_\_\_  
ADDRESS \_\_\_\_\_  
CITY \_\_\_\_\_  
STATE \_\_\_\_\_ ZIP \_\_\_\_\_

VISA  MASTERCARD  
 DISCOVER  CHECK / MONEY ORDER  
CARD# \_\_\_\_\_  
EXP. \_\_\_\_\_

SUBTOTAL \_\_\_\_\_  
HOLIDAY DISCOUNT 20% OFF \$75 OR MORE \_\_\_\_\_  
PLEASE INCLUDE POSTAGE & HANDLING \$ 4.00 \_\_\_\_\_  
TOTAL \_\_\_\_\_



town that's doing both: Chiloquin, in southern Oregon, already has an ordinance arming homeowners, and now they're drafting a city ordinance to form a municipal militia. These things must work — the population of Kennesaw has zoomed since their ordinance was passed, but crime has leveled off. And Janet Reno hasn't, at least yet, invaded those two counties in Florida.

### **WHY IS THIS SO FUNNY?**

As widely reported, "Carlos the Jackal," perhaps the most-sought terrorist of the '70s and '80s, has been seized by French agents in Sudan and extradited to France. At the time, the Venezuelan-born terrorist — who had evidently gotten a little chubby since the terrorist business slowed — was at a hospital run by the Sudanese National Islamic Front (we're not making this up) for liposuction. Once under the anesthetic, Carlos was nabbed and spirited to France, where he faces a number of charges relating to terrorist attacks two decades ago when he wore a younger man's belt.

Lawyers for Illich Ramirez Sanchez, aka Carlos, protest that he was arrested illegally and that he was drugged. Who snatched him off and how the French convinced Sudan to extradite him is not known.

### **MIA COUNTERFEITERS FOUND GUILTY**

According to the Vietnamese trade union paper *Lao Dong*, Frenchman Robert Chaillard, a resident of Vietnam, and 10 Vietnamese accomplices

have been sentenced to prison for terms of three to 12 years for fraud, theft and grave robbery in a scheme to counterfeit U.S. MIA remains.

Chaillard masterminded the scam, which involved robbing miscellaneous graves for Asian bones and other physical remains and producing fraudulent documents, which were misrepresented as those of American MIAs.

### **SWAP: YOUR GUNS FOR THEIR GURUS**

In a plan that could only be proposed in California, Contra Costa County has adopted a gun-swap program that smells to us like tofu, sprouts and sunblock cream: Turn in your heater and get three hours of psycho-therapy in exchange. Well, makes sense to us: Anybody who has to live in the mean streets of California's cities and turns in his means of self defense *is* nuts. Hey, bring 'em to me. My psychobabble is as good as the next guy's.

### **ARMED AND FREEH**

It's official, although we're not sure why it's news: FBI Director Louis Freeh sometimes carries a sidearm. When questioned, Freeh noted, "As part of a full workload, FBI agents must be able to take care of themselves. Like them, I have qualified on the firing range. I am armed when appropriate." Sounds like it would be a great leap forward in stopping violent crime if the average citizen could say exactly the same thing.

### **GUNS AREN'T US**

On the heels of two New York police shootings in one day, of kids bran-

dishing toy guns, Toys R Us, the nation's largest toy retailer, has announced it will stop selling toy guns after current stocks are sold out. Other toys stores have already followed suit.

According to a study by the Police Executive Research Forum, some 15% of all robberies are committed with toy guns. Police department surveys found that more than 30,000 imitation guns were involved in crimes or incidents during the previous five years. In those cases, more than 250 involved a shooting by police, where the subject's activity was later categorized as "non-criminal."

Although 1988 legislation mandated that toy guns have a blaze orange muzzle insert, a study by the National Institute of Justice found that officers confronted with a toy gun "were not able to recognize [the orange insert's] presence, prompting them to fire in nearly all confrontations at both 30- and 15-foot distances." Looks like the kiddies need some instruction, either in common sense or on concealed carry techniques. And as *SOF's* FNG noted: "Looks like I'll have to start stockpiling toy guns, too."

### **LISTEN TO GRASSROOTS RADIO**

Kathleen Marquardt, guiding spirit behind Putting People First and publisher of *From the Trenches* newsletter [and our nominee for the Courageous Common Sense Award] has hit the airwaves with a two-hour call-in show called *Grassroots Radio*, broadcast live over the Talk America Radio Network

from 1600-1800 EST. Available via three telecommunications satellites, *Grassroots Radio* will expand on the scope of animal "rights" and green extremism that have made Marquardt a celebrity, to cover a full range of social and political issues. Most shows will feature a guest interview with listeners calling in on an 800 line. For a schedule of times and stations, contact Talk America Radio Network; phone: 617-937-9390, or Harry Black at Putting People First; phone: 406-442-5700. Best thing to hit the airwaves since Rush Limbaugh.

### **SERGEANT CHAMELEON**

Tech wonks for the Army are working on BDUs that change color to match the GI's environs. The goal is to camouflage a soldier passing from a "woods" setting of greens and browns to a "wheatfield" setting of oranges, tans and browns within seconds. Now, thanks to modern technology, not only one size fits all, but one color will fit all — and it's multi-purpose and man-portable.

### **SEEKS THULE H-BOMB CLEANUP CREW**

Vet is seeking other members of the armed forces who were assigned to clean up debris after a B-52 carrying four H-bombs crashed at Thule, Greenland, in 1968. Especially sought are any servicemen who suffer from a variety of illnesses from skin rashes to cancer. Contact: Richard Sciaraffa, P.O. Box 6834, Kokomo, IN 46904. ✕

# GUN GEAR-Simply the BEST!



Gun Gear's Complete line of top quality leather products are proven profit builders. Just send \$3.00 for your 14-page color catalog, send to address below to Mr. Tiger's attention, detailing Gun Gear's full line of belt holsters, shoulder rigs, ankle holsters and ammunition pouches. Look to Gun Gear for great leather products and outstanding prices. Contact your local dealer and distributor. Distributor and dealer inquiries welcomed.



MADE IN THE USA

187 Lafayette Street New York, NY 10013 (212) 966-6025

# For Impact, Range,

One sure-fire way gets you top-caliber books—the kind you won't spot in bookstores. Set your sights on *The Military Book Club*®.

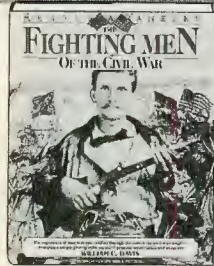

4937-9999\* \$24.95x

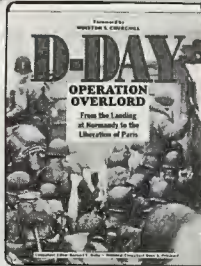

4218-9999\* \$24.95x

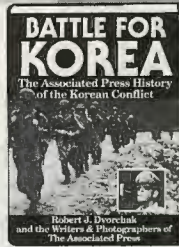

4168-9999\* \$34.95



0570 \$39.95

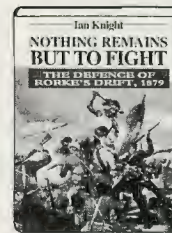

5017-9999\* \$45.00

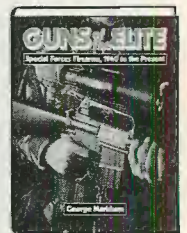

4531-9999\* \$29.95

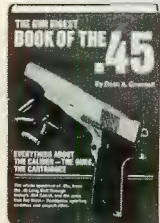

3772+ \$15.95

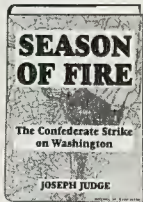

0455 \$30.00



4481 \$27.95

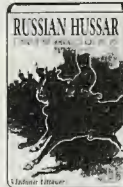

4523-9999\* \$24.95

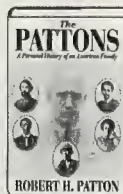

0208 \$25.00



4473++ \$29.95



0042-9999\* \$40.00



4770 \$24.95

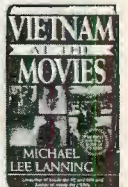

0562+ \$12.50



0414+ \$13.00



0307 \$29.95

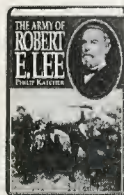

0182-9999\* \$29.95



4705 \$29.95



4093+ \$12.00



9522+ \$9.95x



0554-9999\* \$50.00



0075 \$29.95



0273 \$12.95x

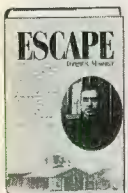

0596 \$29.95

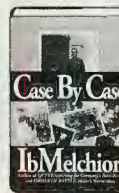

3889 \$21.95



0471 \$29.95

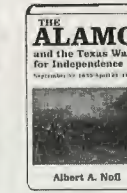

4085 \$18.95



4721 \$12.95x



0091 \$12.95x



2279 \$23.00



0026 \$23.00



0737 \$9.95x



2949 \$22.00

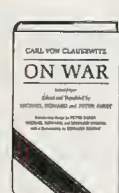

5652+ \$17.50



1677 \$24.95



5165 \$29.50

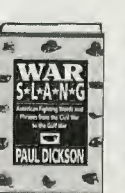

0448 \$25.00



0174 \$24.95



5207+ \$50.00

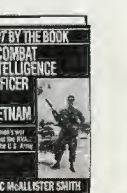

2303 \$12.95x



2733+ \$19.95

\* Counts as 2 choices

x Special edition exclusively for Club members

+ Softcover

++ Fiction

# Accuracy...Use the .98

# 4 for .98

## with membership!

|  |   |   |   |   |   |  |   |   |   |
|--|---|---|---|---|---|--|---|---|---|
|    |    |    |    |   |  |   |   |   |   |
| 3905 \$29.95   | 0331+ \$14.95x  | 5389 \$19.95  | 6791+ \$14.95   | 5249-9999* \$29.95  | 3376 \$19.95  | 3269-9999* \$39.95   |   |   |   |
|   |   |   |   |   |   |   |   |   |   |
| 1289 \$18.95   | 0604 \$23.00  | 4259+ \$19.95   | 5256 \$19.95x   | 5223 \$23.95  | 0018 \$24.00  | 4796 \$25.00   | 7898-9999* \$65.00  | 0364 \$34.95x   |   |
|  |  |  |  |  |  |  |  |  |  |
| 5561 \$24.95   | 4671++ \$22.00  | 3434 \$24.95  | 0349+ \$7.95x   | 5785 \$16.95X   | 3939 \$17.95  | 3012 \$12.95x  | 3053 \$22.95  | 7773 \$29.95  | 1628+ \$14.99   |

### HERE'S WHAT YOU GET WHEN YOU JOIN...

**4 BOOKS FOR 98¢.** Send no money now. You'll be billed 98¢, plus shipping and handling, when your membership is accepted.

**A GUARANTEE OF SATISFACTION.** If you're not 100% satisfied with your books, return them within 10 days *at our expense*. Membership will be canceled and you'll owe nothing.

**THE FREE CLUB MAGAZINE.** You'll receive up to 16 issues a year. Each issue reviews the Featured Book Selection(s) plus a wide variety of alternate books from the Club's extensive library.

**SHOPPING MADE SIMPLE.** To get the Featured Book Selection(s), *do nothing*—it will be sent automatically. If you prefer another book—or none at all—simply return your Member Reply Form by the specified date. A shipping and handling charge (and sales tax, where applicable) is added to each order.

**HUGE DISCOUNTS ON HARDCOVER BOOKS.** Save as much as 30% off publishers' edition prices. Club books are sometimes altered in size to fit special presses.

**AN EASY-TO-MEET OBLIGATION.** Take up to 2 years to buy 4 more books at regular low Club prices. Afterwards, you may resign membership anytime.

**RISK-FREE RETURN PRIVILEGES.** If you get an unwanted book because your Club magazine was delayed and you had less than 10 days to respond, simply return the book *at our expense*.

Prices shown are for publishers' hardcover editions. Club hardcover editions save you up to 30%.

## THE MILITARY BOOK CLUB

Your #1 Source for Military Books

MAIL TO: The Military Book Club  
6550 East 30th Street  
P.O. Box 6357  
Indianapolis, IN  
46206-6357

Please write book numbers here:

|  |  |  |  |
|--|--|--|--|
|  |  |  |  |
|  |  |  |  |
|  |  |  |  |
|  |  |  |  |

57809      42

If you select a book that counts as 2 choices, write the first 4 digits of the book number in one row of boxes and 9999 in the next.

**YES!** Please enroll me in *The Military Book Club* according to the risk-free membership plan described in this ad. Send me the 4 BOOKS I've indicated. Bill me just 98¢, plus shipping and handling.

|   |                     |
|---|---------------------|
| SAVE EVEN MORE! Send me this book now and reduce my commitment to 3 books. Bill me an added \$3.99, plus shipping and handling. Books that count as 2 choices are not eligible. | (write book number) |
| 57808   | 41                  |

Mr./Mrs. \_\_\_\_\_  
Miss/Ms. \_\_\_\_\_  
(please print)

Address \_\_\_\_\_ Apt. \_\_\_\_\_

City \_\_\_\_\_ State \_\_\_\_\_ Zip \_\_\_\_\_

Members accepted in U.S.A. and Canada only. Canadian members serviced from Canada, where offer is slightly different. Sales tax added where applicable. We reserve the right to reject any application.

SOF 1/95

# I WAS THERE

## Trial by Fire

Text & Photos by Thomas Pienta

**O**n the day before Thanksgiving in 1968, the Crusaders, the two lift platoons of the 187th Assault Helicopter Company, had already logged more than three hours of combat assault time. We were on strip alert near the village of Dau Tieng when our flight leader received another mission. He gave the pilots the signal to crank and we began our ritual. It was absolutely essential that we adhered to all flight safety rules and procedures. And that is one of the reasons I am alive today, scarred from second and third degree burns over 45% of my body, but alive.

Immediately upon getting the word, doorgunners and crew chiefs donned their protective vests and helmets. Making sure my Colt revolver rode between my legs, I put on my flak jacket and climbed into the pilot's seat. Before securing the shoulder harness and lap belt, I put my "chicken plate" inside my vest against my chest. The chicken plate was a 22-pound, chest-shaped piece of armor worn inside the flak jacket for added protection. Some pilots sat on theirs.

I slid forward another piece of armor attached to the side of the seat that provided side and head protection. This made it nearly impossible to close your own door so the doorgunners would shut them for us once we

started up the engines. This left the pilot in a very difficult position should he have to exit the aircraft in the event of a fire. I was to discover this first-hand within the next hour.

With the engine run-up procedures completed, I put on my brain bucket and fastened the chin strap. Without securing the helmet it would fly right off your head in a crash, and hair and ears are the first to go in a fire. Our helmets also had visors to provide some eye protection. In spite of the heat, everyone wore their sleeves rolled down and pulled their flight gloves up over the cuffs of their fatigues or Nomex flight suits. We wore leather boots because the nylon in jungle boots would melt right into your feet during a fire.

That particular day I was not wearing my two-piece Nomex flight suit. After having worn it for nearly a week, it stood in the corner of my hootch by itself. Even the rats stayed away from it. For all the money spent during that war, pilots were only issued one Nomex suit and a rusty Colt revolver. Yet, as good as Nomex is, asbestos is really the only thing that would completely prevent burn injuries. But pilots can't dress like bomb disposal experts.

Even though I was a 21-year-old first lieutenant, Warrant Officer Bob Trezona was the Aircraft Commander (AC) — ex-

perience taking precedence over rank — and he was probably the finest pilot in the company. ACs and crew chiefs flew the same helicopter daily unless it was down for maintenance. It was our SOP to assign pilots and doorgunners to a different aircraft each day.

Within minutes of getting the call my chopper was lifting out of the sandbag revetment it was parked in. I glanced back at our crew chief, James Brady (panel 38W, line 71 of the Vietnam War Memorial), and received a

lery prep. I crossed my fingers hoping those HE rounds were finding their targets. Our command and control aircraft ordered us into a trail formation for a short approach with second platoon leading and first platoon following. My aircraft would be last on the ground.

I glanced back at Brady manning the portside M60 and he smiled to reassure me I was doing a decent job flying his Huey. I was amazed at what brave men these gunners were, completely



Ron Timberlake, fourth from the left, risked his life and aircraft to rescue his fellow Crusaders. His overloaded and heavily damaged ship evacuated 10 wounded to safety.

thumbs up. We were on our way.

The platoon headed for a pick-up zone where we loaded our complement of grunts from the 25th Infantry Division. With our six 11 Bravos in each aircraft we headed for the Rendezvous Point (RP) to form up with the second lift platoon. As we orbited over the RP we could see the LZ in the distance being pounded with an artil-

lery prep. I crossed my fingers hoping those HE rounds were finding their targets. Our command and control aircraft ordered us into a trail formation for a short approach with second platoon leading and first platoon following. My aircraft would be last on the ground.

Warrant Officer Ron Timberlake, flight leader for first platoon, ordered us into a heavy echelon left. We made a sweeping left turn onto our final approach path just as the artillery prep ended. Turbulent air from the rotor wash of 10 aircraft caused the instrument panel to shake and vibrate so vio-

# DutchGuard By Mail

Order toll free  
1-800-821-5157

## SOVIET SUBMARINE CLOCK



### A COLD WAR TESTAMENT

This clock was standard issue on soviet nuclear attack subs. The twelve jewel movement & six pound weight are proof of the Russian mania for rugged top quality. Gasket sealed & housed in a waterproof aluminum alloy case with fine chrome trim. Good looking large dial displays a double fluke anchor, silhouette of a sub conning tower, large red star, & Cyrillic script. The spring wind mechanism & ingenious hatch cover utilize the same key. *After nearly fifty years-* Here is LIVING PROOF that times have changed. A bona fide showpiece. Case diameter: 8", dial: 6", eight day twelve-jewel movement. Unused, never commissioned Soviet sub clock comes with: easy wall mounting plate, certificate, warranty. Be advised-this is a real find. We don't have many to sell. Order R-SUB \$80.00 add \$7.50 shipping.

Order 3 @ \$62.00 each (\$186.00) plus \$10.00 shipping.

US  
MILITARY  
TRITIUM VIALS

### LEAN, MEAN & ALWAYS SEEN\*



\* Because TRITIUM VIALS never lose their light! The common phosphor paint used in every watch is no better than its last light source "fix" and it rapidly fades. But Tritium Vials actually contain the hydrogen isotope Tritium encapsulated in tiny, air tight compartments and constantly illuminate at full blast strength. Miniaturization and Lasers: Each hardened vial is laser sealed and then mounted with precise tolerance to the hour and minute hands, and beside each number. The hands illuminate red, the numbers blue with one red (the 12) as the set reference. The result is a self-illuminating watch as easy to read at 2300 as straight up noon. Twenty-nine pages of Mil Specs guarantee rugged combat quality. Large analog face. Stars & stripes are red, white and blue. Calendar, stainless steel band, Waterproof, Swiss Quartz, one year manufacturer's warranty, military data and code numbers incised on back of case. As the sun dips west this watch turns on - and it stays turned on. Quite an effect over candle light dinners. Unlike any watch you've owned before! Order #UST, \$130.00

## AMAZING STARLIGHT NIGHT VISION SEE IN THE DARK



THIS IS THE SAME TECHNOLOGY USED BY MILITARY & TV NEWS CREWS WORLDWIDE.

MILITARY NIGHT VISION BINOCULARS: NOW AVAILABLE TO YOU.

Formally, private citizens, when they could find them, shelled out thousands of dollars for night vision binoculars and counted themselves lucky they'd found them at all. Now through special contacts deep inside mother Russia we can offer night vision for a fraction of the old prices! Prices will never be lower & Russian combat equipment is absolute TOP quality. (the military always got the best money could buy) How night vision works: Reflected light is amplified TENS OF THOUSANDS of times inside the binoculars. Faint light, even STARLIGHT is more than adequate to completely illuminate your field of view. Objects INVISIBLE to the naked eye are clearly defined. Surrounding space is filled with the familiar "starlight green glow." Magnification of 2.5 power lets you see even distant objects sharp & clear. Wide 237-ft. field of view at 300 yards. Many surveillance & security applications. Runs on two AA batteries which supply power for a full ten hours. Light weight (2 lb.) with 15 degree viewing angle; 42mm objective lens. Focusing rings adjust +/- 4 diopters. OVER 30,000 TIMES light amplification. Very easy to use with clear instructions. Brand new equipment. Warranted for one full year. Order #STAR, \$500.00

### VOICE CHANGER TELEPHONE



SIXTEEN DIGITAL VOICE CHANGING MODES are built into this standard desktop telephone. Change your voice from male to female, female to male, adult to child, child to adult & "cartoon" voices. Use as regular voice phone or switch to Voice Change Mode (lighted mode indicator). Tone/pulse, last number redial, hearing aid compatible, FCC registered, UL & CSA listed, warranty. Precise & realistic voice masking is ideal security for women & children home alone, as a home/business "screening" device, and discourage annoying callers. Money back guarantee, order #VCT, \$89.00

### KGB SPY BINOCULARS

Much sought after by undercover operators these KGB spy binoculars are designed for close in surveillance. Precision ground optics are coated with special low light enhancers. These spy binocs are so lightweight and tiny they were nicknamed "Hummingbirds" by their Soviet users. Duty agents routinely joked they were going bird-watching. (One of their many legal uses) But they can also read a computer screen at twenty paces or pull in a licence plate in twilight conditions. Military grade optics and advanced coating give unbelievable punch to these tiny dual focus 2.5x 17.5 spyscopes. Case included. Order #KGB/SPY \$29.95



MC/Visa & COD orders call toll free 1-800-821-5157

Mail in orders send check or money order to the address below.

DutchGuard

Dept. SOF

P.O. Box 411687

Kansas City MO 64141

Item price

\$5.00 shipping charge

\$5.00

Total enclosed

Name

Address

City

State

Zip

©1994  
Satisfaction Guaranteed.

lently I could barely read the gauges. Our ships were close enough together you could read the name tags of the aircrew in the next bird. The pucker factor remained at redline. Flying on either side of the formation in oval racetrack patterns our gunship platoon, known as the Rat Pack, prepped the LZ and beyond with mini-gun fire and 2.75-inch rockets. We ordered our doorgunners to engage the enemy with full suppressive fire, left and right.

My heart pounded furiously as I struggled to control the warbird. Over

We had to pick our spots carefully and slowly, drawing even more fire. This was not the way we normally wanted to do things, but a tail rotor in the trees was just as deadly as machine-gun fire.

Having just brought the aircraft into a hover, I heard a big *whoosh* similar to a propane grill lighting after the gas has been left on too long. I first thought that a fragmentation grenade had inadvertently been dropped in our ship by one of the grunts. Not so. A rocket-propelled grenade had slammed into my Huey, hitting the left

rotor system crashed into my helmet and knocked me sideways across the AC's seat — Trezona was gone; he had apparently stood up and fallen straight forward out of what was left of the helicopter.

Lying across the AC's seat, I truly thought I was going to die. I could no longer hold my breath and was sucking the burning heat into my lungs. I had to try and escape again. I successfully stood up and lunged between the two pilots' seats and out the cargo door. There was no need to step down — my bird was disintegrating into a black spot on the ground. As I broke free of the flames I was afraid of another explosion, but there was nothing left to explode. The aircraft just blazed out of control.

I ran about 20 yards and rolled on the ground to extinguish the flames on my body. I put my hands in a puddle of water to cool them off. Surprisingly, that was the only pain I could feel. My fingers were pencil thin after being cooked inside the leather gloves but they were still there. I could tell my flak jacket and chinstrap were still on fire, so I removed them. Due to the intense heat, I doubt my Nomex flight suit would have made any difference; it was my flak jacket that saved me.

It was becoming more and more difficult to make my arms and legs bend, but at least the pain was gone — third-degree burns kill the nerve endings. I wanted to get as far away from the aircraft as possible, but unknowingly I was running closer to the NVA. Heavy, black smoke from the crash must have obscured our movements and pre-

vented the NVA from decimating my crew with small-arms fire. They were still shooting at us but couldn't pinpoint a target, or perhaps they wanted to wait and capture us — they liked to behead helicopter pilots.

Our gunships were still circling and expending the last of their ammunition and rockets. Although they couldn't see any more than the NVA, they knew what to do. One gunship, already out of ammunition, stayed on station continuing mock gun runs only 30 feet off the deck while the other ships left to rearm. By making these unarmed orbits he kept NVA heads down and prevented them from venturing out to capture us.

By watching the gunships I was able to orient myself enough to run back toward my helicopter and away from the enemy. Shock was setting in and I could see how badly my arms and legs were burned. I came upon a small group of wounded, possibly the grunts who had been in my helicopter, and told them to take my revolver and use it if they needed to because my hands were useless. They just stared at me like I was a monster who had emerged from the smoke.

I found Trezona stumbling in my direction, his face scorched black with his helmet still on his head. We worked our way toward a Huey waiting on the ground. It was Timberlake. When we failed to call in a clear LZ and he saw an aircraft burning on the ground, he knew what had happened and was determined to rescue us. He kept his aircraft on the ground until all 10 wounded were

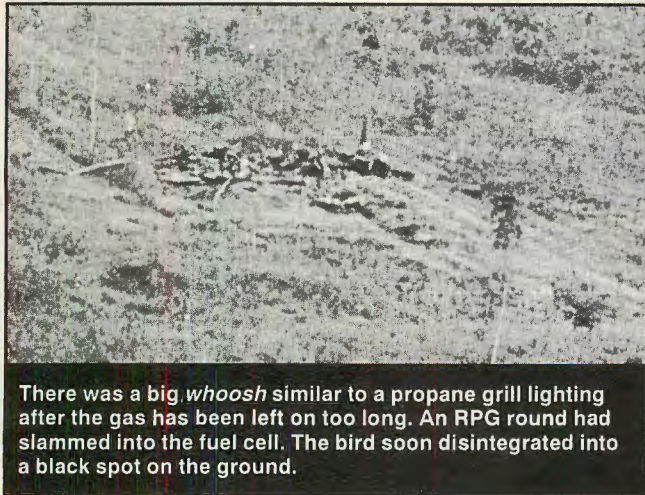

There was a big *whoosh* similar to a propane grill lighting after the gas has been left on too long. An RPG round had slammed into the fuel cell. The bird soon disintegrated into a black spot on the ground.

the radio I heard, "Chalk One receiving fire, Chalk Two receiving fire, Chalk Three receiving fire." This was combat — you didn't break formation, you just sucked it up and flew right on into hell. Each helicopter was racked with intense machine-gun fire, and rocket-propelled grenades swooshed by as the choppers flared to land and unload infantry.

I continued my approach into the hot LZ, watching every aircraft in front take fire. As the trail helicopter, it was my job to wait until every Huey made it out and to call in once the LZ was clear. The area was filled with 10-foot tall rubber trees.

fuel cell just aft of Brady's gun position; he died instantly. Private Hoppe, the right doorgunner, was blown out of the ship. We were completely engulfed in flames as JP-4 ignited the magnesium and aluminum aircraft. All the oxygen was immediately consumed by the flames.

I instinctively stayed on the controls trying to remain in command of the ship but the Huey fell about 15 feet to the ground. Remarkably, it stayed upright. I couldn't see or breathe but unbuckled my shoulder harness and lap belt knowing it would be impossible to exit through my door. As I stood up, the collapsing

loaded, while the NVA fired RPG after RPG at the Huey. Timberlake noticed the gunner in a tree, his black-pajama-clad assistant on the ground handing him rockets, and directed his doorgunner to riddle them with M60 fire.

As Timberlake began to take off, his instrument panel glowed red with warning lights. The Huey was taking a heavy beating from small-arms fire and was grossly overloaded. He lifted the fragile bird out of the LZ, but we were continuously racked with machine-gun fire. The warbird managed to fly only a short distance when the exhaust-gas temperature rapidly decreased and the engine oil pressure dropped to zero — the Huey's engine had quit. Timberlake entered autorotation, a power-off landing, and gracefully put the ship down in a rice paddy. All 14 on board immediately began to set up a perimeter around his Huey, but before the rotor blades stopped turning, another slick swooped in to pick us up.

Although deep in shock, I remember being in the back of the third helicopter that day and shaking my head in disbelief. My thoughts turned to my parents and how upset they were going to be when they found out I had been burned. I was also mad because I knew my flying days were over.

As we flew toward Tay Ninh and the field hospital my vision became hazy. I was beginning to realize just how seriously burned I was. We landed at the medevac pad where we were met by medics, but I walked into the field hospital under my own power. The last thing I remembered for the next month, except for short periods of pain and consciousness, was a doctor cutting off my flight gloves and seeing the flesh removed with them. He also cut off my OCS ring and watch — that was the last I saw of them.

I was evacuated to Saigon, then to Japan and finally to Brooke Army Medical Center at Fort Sam Houston, Texas. My hospitalization lasted 18 months, the equivalent of a tour and a half in Vietnam. I eventually returned to duty and

Continued on page 64

## CRIMINAL INTELLIGENCE ADMINISTRATION

International Consulting clearinghouse with thousands of contacts world-wide is now offering to the public for a limited time, a one stop, 24 hours a day, resource firm used by Corporate America since 1987. Members will be able to:

- Buy, rent or lease security and intelligence equipment from Manufacturers or distributors world-wide at a savings of up to 70%
- Attend security and intelligence training programs at group rates, a 60% savings
- Attain confidential intelligence regarding terrorist operations world-wide
- Know where to get those hard to find intelligence items
- Learn how to receive free security subscription services,
- plus many other great benefits.

1 yr. membership=\$39.95/ 2 yr. membership=\$65.80/ Gold Lifetime member=\$299.75

Send name, address & telephone number, plus check or money order (membership will be held for check clearance) to Criminal Intelligence Administration, International Clearinghouse, Public Program, P.O. Box 5310, Astoria, NY 11105, USA.

# STEROIDS

## D-BALL TEST JET DECA

Anabolic Steroids build Muscle Mass and Strength  
Now there are safe and effective replacements for steroids

### PRO BODY® Power Formulas

#### Leading Steroid Replacer

Huge gains in muscle mass and strength have been reported from Boron users. Completely legal and no side effects. Gains won't be as good as with steroids for most, but response is great and lifters are coming back for more. The extra edge. Boron.

BORON 3 month cycle #55001 \$15.95

#### The Real Thing - Dibencozide

Dibencozide has proven Anabolic effects. Gain Weight. Get Strong. Fast Recuperation. Guaranteed. The problem is that a lot of the Dibencozide out there is not real. PRO BODY Dibencozide is the only one that comes with a copy of the lab analysis that proves it is 100% real. Get big today.

DIBENCOZIDE 90 caps 10mg #55006 \$34.95

#### Build Mass and Lose Fat

Human Growth Hormone increases lean Mass and decreases body fat. The ingredients of GH Power Formula have been proven to naturally increase Growth Hormone levels up to 700% in 90 minutes. GH levels still 300% higher 8 hours later. Get the hard look with GH Power Formula.

GH POWER FORMULA 90 tabs #55024 \$24.95

GH POWER FORMULA 180 tabs #55025 \$44.95

#### the ultimate Mass Formula

Get big now. Combine all of the best Power Formulas for Ultimate gains. Boron, Dibencozide, Yohimbe, Smilax & Amino's in a huge 60 day cycle. Guaranteed Size. Get it all with the Mass Formula. At a 30% savings.

MASS FORMULA 60 day cycle #55050 \$89.95

All PRO BODY Power Formulas are 100% GUARANTEED or your money back

FREE CATALOGS

CALL 1-800-962-4769 ask for dept. #695

FAST SHIPPING

Toll free - 24 hours - 7 days

Send to: JTR Labs - 10230 Bach Blvd., Dept #695 - St. Louis, MO 63132

For questions and local orders call 314-426-7040

### RUSH ORDER FORM



Name (as on card) \_\_\_\_\_

Address \_\_\_\_\_ Apt.# \_\_\_\_\_

City \_\_\_\_\_ State \_\_\_\_\_ Zip \_\_\_\_\_

Phone#( ) \_\_\_\_\_

Card# \_\_\_\_\_ Expires / \_\_\_\_\_

SEND TO: JTR Labs  
10230 Bach Blvd. - dep#695  
St. Louis, MO 63132

| PRODUCT | ORDER# | QTY | PRICE | TOTAL |
|---------|--------|-----|-------|-------|
|         |        |     |       |       |
|         |        |     |       |       |
|         |        |     |       |       |

-IMPORTANT ORDERING INFORMATION  
-Foreign orders add 25% of total in US funds  
-Fedex 2nd day air add \$5.00  
-COD orders add \$4.00  
-AMEX must be shipped to billing address  
-Dealer inquires welcome

|                       |  |  |  |      |
|-----------------------|--|--|--|------|
| SUB TOTAL             |  |  |  |      |
| SHIPPING              |  |  |  | 4.00 |
| Missouri add X .06225 |  |  |  |      |
| OTHER                 |  |  |  |      |
| TOTAL                 |  |  |  |      |



# WORLD SITREP

1

## UNITED STATES

During Gulf War, U.S. Marines engaged Iraqi artillery from 1,500 meters with Barrett .50-caliber sniper rifles. Aiming for the gun itself rather than crew, the heavy projectiles were successful in disabling the weapons systems for cost of a \$2 bullet instead of \$500 shell or \$10,000 missile.

U.S. Navy begins to retire some of its "combat dolphins," specially trained animals which were used to protect harbors and carry sensors into enemy waters.

CIA investigation reveals that Aldrich Ames did far more damage than previously suspected: exposing at least 55 CIA operations and 34 agents, 12 of whom were captured and executed. Clayton Lonetree, Marine sergeant jailed for spying for Russians at American Embassy in Moscow, petitions for release on grounds that he was framed by KGB to cover up leaks by Ames.

4

## INDIA

U.S. envoys propose a regional nuclear arms control pact for India and Pakistan asserting that Indian nuclear weapons program has raised regional tensions. Reports indicate that India could build plutonium-fission bombs and may be able to build a hydrogen bomb, while Pakistan can produce a solid-sphere fusion device based on a Chinese design.

11

1

5

## NORTH KOREA

North Korean soldiers are spotted wearing Kim Jong-II badges, indicating military has finally agreed to support him as new "great leader."

8

6

3

## SPAIN

Maria Idoia Lopez Riano, female Basque terrorist known as the Tigress, is captured by French police and arraigned in Paris.

9

## SWEDEN

Scientists determine that a particular sound pattern, long thought to be intruding Soviet submarines, is in fact caused by seals, accounting for some of the submarine hunts over the past 15 years.

10

## LIBYA

Muammar Khadaffi celebrates 25 years in power. Out of his original group of 12 officers that overthrew King Idriss, two did not appear because of disagreements and the other two surviving members were reduced to mere protocol roles, indicating deep divisions within Libyan government.

15

14

## IRAQ

United Nations Security Council summons Iraqi ambassador to explain troop movements toward Kuwait. Republican Guards divisions mass nearly 64,000 Iraqi troops on border. President Clinton deploys over 50,000 servicemen to the area, including nearly 700 aircraft. Defense Secretary Perry threatens U.S. will not keep its troops in Kuwait indefinitely if Hussein does not withdraw. Iraqi forces pull back from border area in light of a continual U.S. buildup. Clinton searches for a way to contain Hussein that is palatable to Coalition forces.

2

### RUSSIA

Chechen President Dudayev is warned that only his resignation will prevent a civil war. Dudayev accuses Russia of launching helicopter and tank raids on outskirts of Grozny, predicts an invasion and orders Russian journalists to leave. Sporadic fighting breaks out as opposition militias try to oust the nationalist leader.

Having decided that Russian generals are vulnerable to recruiting and subversion by radical states, the United States will help fund a program to ensure these officers are paid enough to retire comfortably.

3

### AUSTRIA

Austrian officials seize 10 optical fire-control systems for U.S. M60 tanks while shipment was en route from Slovenia to Iran. It is known that Iran has M60 tanks, but there is no indication where the stolen equipment came from.

7

### SUDAN

Peace talks collapse when government refuses to drop plans to impose Islamic Sharia law on non-Muslim southern regions. Government officials deny allowing Islamic militants in Sudan to conduct insurgency raids into Egypt and Uganda, and request that Zimbabwe stop supporting SPLA rebels inside Sudan. Rebel leader Garang vows to return to jungle to fight for freedom of the southern people.

2

6

### NICARAGUA

President Chamorro signs new law allowing president to reject candidates for top military posts proposed by military council, effectively ensuring civilian control of the armed forces.

3

12

14

10

7

11

### CANADA

Last American military base in Canada is closed: a submarine detection station at Agentia.

4

12

### BULGARIA

Police discover 19 containers of radioactive material hidden in cellars of two homes in Sofia. The material, including plutonium, strontium and cesium, appears to have been stolen from inside Bulgaria.

13

### CAMBODIA

Army continues siege of Vine Mountain, demanding Khmer Rouge release three remaining living hostages. Despite leaky cordon around Vine Mountain positions, government troops have turned back repeated KR attempts to break out.

13

15

### BRAZIL

Defense officials are negotiating to buy approximately 200 Russian T-72S tanks to replace their ancient M41 force after two failed attempts to produce their own main battle tank. This would give Brazil the most powerful tank force in Latin America.

A Brazilian warship is following the *Greenpeace* on its month-long voyage up the Amazon River.

World SitRep is excerpted from the biweekly newsletter *For Your Eyes Only: An Open Intelligence Summary of Current Military Affairs*. Published by Tiger Publications, P.O. Box 8759, Amarillo, Texas, 79114-8759; subscriptions are \$65 per year (26 issues). Sample issue available for \$3. Those interested in reliable, up-to-date world intel are encouraged to subscribe.

# COMBAT WEAPONCRAFT

## Two Hits Per Customer

by Gabriel Suarez

**M**odern pistol technique promotes the "Standard Defensive Response" of two quick shots to the chest. Two shots instead of one because no pistols can guarantee 100% stopping power, and two shots tend to multiply the power.

On difficult targets, two shots increase your chances of obtaining at least one solid hit, and there is always the possibility of missing with the first shot. This technique has acquired the unfortunate, imprecise name "double tap," but there are too many firing modes with the pistol to lump them all under that one term.

The method used to deliver two quick shots varies with the situation. Shooting cadence depends on target proximity. Generally, the closer the adversary, the faster you can shoot and still hit. A closer target is a much easier target and a *much greater threat* than a distant target. Conversely, the farther the target, the longer you may take to shoot. Allowable time to react decreases with proximity, thus a target at five feet must be hit much faster than at 50 yards.

The first, most basic, firing mode is the *controlled pair*. Think of the controlled pair as two one-shot strings. We shoot and hit with the first shot and only fire the second shot after reacquiring the sight picture and making any adjustments to realign the pistol.

With continuous prac-

tice the time interval between shots decreases. This can be attributed to recoil control, which is largely assisted by a proper firing platform. A proper firing platform allows the pistol to return from recoil to the same general alignment as the first shot. The speed with which the pistol returns to the target determines the speed with which you can fire the second shot.

The second mode is a natural progression from the first, differing only in the accelerated cadence. Greg Morrison, former operations manager of the American Pistol Institute and author of *The Modern Technique of the Pistol*, calls this the *dedicated pair*.

For closest encounters, those in the 7-yard range, use the *hammer*. This term, coined by Jeff Cooper, indicates a cadence even more accelerated than the previous methods. Think of the hammer not as two one-shot strings, but as one two-shot string.

In the hammer use the flash sight-picture for the first shot as fast as you can hit. Then as you recover and the pistol indexes back on target, shoot again. You may try to pick up a glance at the sight picture but do not "wait" to see it. You simply time the second shot to coincide with the return of the pistol to the target. A proper firing platform provided by the Weaver stance allows the pistol to fall into place through muscle memory and be-

cause of its muzzle-flip dampening qualities.

To recap, think of the *controlled pair* as *sight, shoot, recover, sight, pause, shoot*, whereas the dedicated pair is *sight, shoot, recover, sight, shoot*. The only real difference between the two is the accelerated cadence possible with proficiency. The *hammer* is *shoot, recover, shoot*.

Mike Waidelich, former Gunsite pistol instructor,

you will be "down shifting" or slowing down for the second shot as you seek the flash sight-picture. The difference here may only be tenths of a second but it bears examining by the advanced shooter.

A third variation developed by Cooper is called the *split-hammer*. This is a very specialized technique for sorting out two adversaries who are standing close together. We hit the first man with



Correct Weaver stance fosters rapid pistol recovery for a fast second shot. Photo: G. Suarez

developed the *reverse hammer*, because missing the first shot is much more probable than missing with the second. With the standard hammer the first shot is "sighted" and the second is kinesthetically aligned, based on the placement of the first shot. With the reverse hammer, muscle memory is used to get the pistol on target in a Weaver stance, then shoot. When the pistol returns from recoil, pick up the flash sight-picture and use it to fire again. Hitting the adversary immediately is paramount. If you've missed with the first shot

the first shot of the two shot-string, then shift the pistol laterally on recoil, using the time between shots to "travel" to the second man: arriving at the second man, shoot! You *may* see the front sight superimposed on the second target's chest, but do not *wait* to see it. Using this technique on two targets at five yards, experts can expect times of less than 1 1/2 seconds.

Other firing modes are natural progressions of the previous drills. One is the *Mozambique drill*,

Continued on page 60

# Learn To Fight Like A Navy SEAL!

## This Elite Hand-to-Hand Combat System Used by the Navy SEALs Can Turn You Into The Invincible Street-Fighter You've Always Wanted To Be!

Now, for the first time ever, the same fighting techniques from the *official* "SEAL Team Unarmed Combat Course" are being revealed to civilians who want to possess some of *the most powerful self-defense skills known to man...* taught to you by Seal Team Member FRANK CUCCI — the same man who teaches this system to the Navy SEALs!

by Bob Taylor, Defense Training Specialist

**I**t's true! Now you can learn the exact same hand-to-hand (unarmed) combat system used by the elite Navy SEALs!

This is the *official* "SEAL Team Unarmed Combat Course" that has helped enable the SEALs to emerge victorious from *hundreds* of deadly, real-life combat situations — and has helped them earn their revered status as the best-trained fighting men in the world!

The man who developed this amazingly powerful martial arts system for the SEALs is **Frank Cucci**. Himself a former member of the legendary SEAL Team Six, Mr. Cucci has recently decided — for reasons of guaranteeing public safety — to reveal to the U.S. civilian population the highly-effective hand-to-hand fighting system that (until now) he has taught *exclusively* to the Navy SEALs!

Mr. Cucci (a life-long expert in the martial arts and a Navy SEAL for 12 years) is free to teach his unique system to the public because he is no longer on active service duty with the SEALs. This means that, *for the first time ever, civilians can learn to defend themselves on the streets as effectively as if they had been trained for jungle warfare!*

And let's face it...

**It IS a jungle out there!**

No matter where you are, in broad daylight or in the thick of night, **YOU ARE THE**

**TARGET** for an increasingly vicious, drug-crazed criminal element that thinks nothing of killing, robbing, raping, and terrorizing innocent people — mostly for money, but sometimes for the sick "pleasure" they get out of it!

I don't know anyone who would feel 100% safe walking the Big City streets these days. But imagine how much safer *you* would feel if you knew what the combat-toughened Navy SEALs know about hand-to-hand fighting!

Fortunately for you and your loved ones, **now you can!**

In this amazing new 2-hour video produced by Tactical Response Solutions, Frank Cucci will teach you the same incredibly effective fighting skills he teaches the Navy SEALs. After just a few lessons, you can possess the awe-inspiring confidence of a Navy SEAL. Plus you'll "have what it takes" to emerge victorious from deadly hostile situations!

And the best part is...

**This system is simple,  
easy to learn,  
easy to remember, and  
(above all) highly effective!**

Once you see this explosive fighting system in action, you'll immediately realize why it will make you a "natural" at down-and-dirty street fighting.

It was designed with the most intense jungle

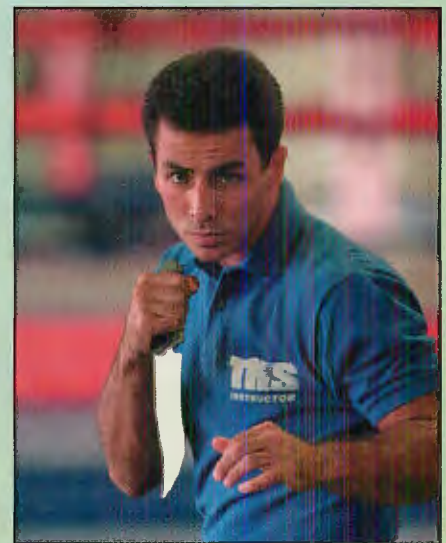

**Frank Cucci — Former SEAL Team member and developer of the SEAL Team Unarmed Combat Course.**

warfare in mind, where *everything* can get screwed up at a moment's notice!

You see, the SEALs are often forced to fight even though they're starving, dehydrated, have just swam two miles in the ocean with a full pack on their backs, crawled or ran through mud or sand for another two miles, and then (not uncommonly) caught without even a knife to defend themselves with!

The only fighting system that would work

under *those* conditions would be one that's simple, easy to use, easy to remember, *and as deadly as a machine gun!* And that's the system designed for the SEALs by Frank Cucci and now revealed to you for the first time on Frank's new video!

### Here's what you'll learn!

Right from the start, Frank gives you a simple set of techniques that you can confidently rely on *no matter what situation you find yourself in!*

From aggressive kicks and punches to defensive blocks and take-downs, you'll discover what are *really* the most potent (and the most natural) moves to make with your bodily weapons. For instance...

- ◆ Use *this* little-known defensive stance to make sure your body is *never* vulnerable!
- ◆ How to be *instantly* prepared for a fight at any moment, especially when everyone else is taken off guard!
- ◆ Efficient, economical punches that pack the wallop of a .44 Magnum!
- ◆ A *deadly mistake* most people make when they throw a punch!
- ◆ How to put together the *right moves* that the SEALs have found are the *key* to survival in a fight!
- ◆ The most practical (and most *devastating*) tool for short-range fighting. You'll be amazed at how easy it is!
- ◆ "Punishing" blows that will disorient your opponent and allow you to finish him off!
- ◆ How to end a fight *before* it even starts!
- ◆ The 5 *key* elements to winning *any* street fight!
- ◆ How to blow an opponent back with *one simple move*, giving you time to regroup or move in and deliver *your* attack!
- ◆ How to eliminate all vulnerability to your head in one easy step!
- ◆ The bottom-line "secret" of effective combat that *not one guy in a thousand* truly understands or appreciates!
- ◆ The essential factor that will determine *who wins* in 8 out of 10 combat situations!
- ◆ How to use defensive moves to set up the most devastating *offensive* attacks!
- ◆ How to quickly and easily neutralize *any* punch or jab your opponent throws at you!
- ◆ A dangerous mistake most people make

with their *eyes* when fighting — and how to avoid it!

- ◆ The right way to *breathe* during a fight so you can keep on fighting your strongest!
- ◆ How to take advantage of your *natural body mechanics* to deliver the most effective blows!
- ◆ The simple (but highly-overlooked) key to making your practice sessions *pay off* in real life!
- ◆ An amazing leg technique for blocking an opponent's advance and then *letting him have it!*
- ◆ How to defend yourself against high kicks *without* exposing yourself elsewhere!
- ◆ Where to kick your opponent to make him numb, nauseous, and *begging for mercy!* (No, it's *not* the groin!)
- ◆ A simple but devastating technique that can get you out of *any* tough situation—*FAST!* (Use this "sure thing" strike *especially* if your opponent is bigger and stronger than you, or if you're simply out-numbered!)
- ◆ A *nasty* "no-brainer" combination that will immediately give you the upper hand in *any* fight!
- ◆ When all else fails, use *this* highly effective move — especially in life-or-death situations!
- ◆ How to manipulate your opponent's body in preparation for a *lightning-fast take-down!*
- ◆ How to cut off your enemy's air flow or blood supply and cause *unconsciousness* when grappling on the ground!
- ◆ What to do if you get thrown on the ground by surprise and your opponent jumps on top of you!
- ◆ The right and the wrong ways to defend yourself against *multiple attackers!*

**Sound good so far? You bet! And I've only touched the surface!**

In one of the most exciting segments of this 2-hour video, Frank Cucci teaches you the most effective ways of fighting against someone with a *stick, club, or knife!* You'll learn defensive moves. Offensive moves. Proper footwork. Combinations. How to *improvise* a weapon. And most importantly, **HOW TO WIN** when faced with such a deadly attack!

I could go on, but I think you get the point:

This video is *packed* with the most intense fighting techniques known to man — all of which have been proven successful by the Navy SEALs in real-life, cut-throat combat missions around the world.

Listen: If the SEALs can use this fighting system to defeat the kinds of enemies *they* face, think of what it can do for you!

### **Better than being there!**

Can you really learn this fighting system by watching a *video*? In *this* case, **YES!**

In this high-quality video, you get not just one, not just two, but **three** different camera angles to view Frank's techniques! The producers spared no expense. They wanted you to be able to watch this video and learn to fight as well as if you were there in Frank's dojo, watching him move on the mat.

You'll even see the moves in *slow motion* — something you can't get in real life! (Not to mention the ability with your VCR to see things *over and over again* until they become *ingrained* into your subconscious!)

And you'll especially appreciate how each move is *thoroughly and painstakingly* explained by Frank. His years of experience using this system and teaching it to the Navy SEALs has given him the ability to make it "clear as a bell" to anyone watching it for the first time — even to people who previously knew nothing about the martial arts!

Plus, once Frank has finished teaching you a particular group of moves, you'll see him *use* those moves in highly instructive "free form" training sessions with his partner. By imitating his smooth, fluid moves in your own practice sessions, you'll be making a "quantum leap" in your fighting ability.

Without exaggeration, you'll accomplish in a few practice sessions what it takes most martial artists *years* to learn!

### **Too powerful to abuse!**

You're going to *love* this videotape. I guarantee it. And I dare say that, after watching it, you might even be a little bit *too* self-confident!

It's *that* powerful. And the fighting techniques it teaches you are so simple and yet so forceful, you'll feel unstoppable.

But please, use them prudently and wisely. Don't go out there looking for trouble. If it comes your way, you'll be more than adequately prepared for it. But don't think you have to "prove" to anybody how invincible you are now.

That's *not* the reason Frank is letting you have this well-guarded knowledge. He's only doing it because he knows how dangerous the streets are today, and he doesn't like seeing

good people like you get victimized by "domestic enemies."

If you have any vendettas or scores to settle, leave them at the door when you watch this video. Otherwise you could get into some very serious legal trouble for improper use of martial arts. These fighting methods are only to be used when your life or physical well-being are in *imminent danger—and for no other reason!* (They're just too deadly otherwise.)

That being said, let me explain how Frank Cucci developed the SEAL Team Unarmed Combat Course (and why it's so powerful)...

### **3 of the most-lethal fighting systems in the world, combined into one!**

"The SEAL Team Unarmed Combat Course" is actually Frank's own specially-designed combination of Thai kick-boxing, Filipino martial arts, and Bruce Lee's street-fighting system: Jeet Kune Do.

**"I don't think I need to remind you: *IT'S A JUNGLE OUTTHERE!* But now, for the first time ever, civilians can learn to defend themselves as effectively as if they had been trained for *actual* jungle warfare — *straight from a Navy SEAL!*"**

These Oriental fighting styles are purely for *combat*, not for sport. As such, they transcend anything else known to man. Once mastered, they make every part of your body a *lethal weapon*.

And best of all, Frank learned these styles from their greatest living masters...

The legendary **Dan Inosanto** — who was Bruce Lee's training partner for 9 years and one of only *three* people ever granted "Instructor" status by Bruce Lee — is Frank's "guru" for Jeet Kune Do *and* the highly-potent Filipino martial arts.

For his Thai kick-boxing training, Frank studied under **Master Chai Sirisute**, President of the Thai Boxing Association of America.

And now *you* will be able to study under the same man who *developed* this course and taught it to the Navy SEALs!

Indeed, there is no better instructor than Frank Cucci to learn from. And the moment you see him in action, you'll realize why the SEALs picked him as *their* instructor.

Frank has been practicing the martial arts for 16 years. During his 12 years as a member of the SEAL Team, his numerous combat missions helped him hone his hand-to-hand

fighting system to a fine precision.

When the SEALs would come back from a mission, Frank would work with them to evaluate what worked and what *didn't* work in real-life combat. That which worked was studied deeper, and perfected. That which didn't work was tossed out.

So now you get to benefit from over a *decade* of the SEALs' hard-learned lessons and tried-and-proven fighting techniques, all rolled up into the most efficient method possible for teaching this military-level system to civilians!

### **Simple + Efficient = Easy to Learn!**

Frank has taken the SEAL Team Unarmed Combat Course that he teaches the SEALs and boiled it down into a tightly edited, power-packed 2-hour video.

To be honest with you, it even surprised *me* that his system could be so effectively taught

enforcement officers have to say after using Frank Cucci's SEAL Team fighting system in real life situations...

### **Recommended by Soldiers and Cops Alike!**

*"Training with Frank Cucci has given me the ability to defend myself with both empty hand techniques and weapons. This training has given me the confidence to handle aggressive people in a variety of different situations and ranges."* **James Matthews, Ret. Navy SEAL**

*"I'm an ex-special operations soldier trained in Shotokan Karate, Tai Kwan Do and American boxing. Frank's system is by far the best and most effective fight training I've ever had... and I've had occasion to use it to win at least one violent encounter in civilian life."* **Vance Richmond, Ex-DELTA Team Member**

*"The Training provided by Mr. Cucci is not only unique in its extreme effectiveness, but also in its simplicity and adaptability. It was this training that was crucial to my surviving an encounter against a mentally disturbed person armed with a large butcher knife."* **Tony Torres, Police Officer**

*"I can judge fighting systems because I've been in more than a few serious scraps myself. This is not fluff. I definitely want Frank and his knowledge on my side in any tough spot."* **Steve Falkner, Wing Ching Instructor, Virginia**

*What can I say about Frank Cucci. He is nothing but the truth. What an instructor! If I ran into (Frank Cucci) in a dark alley, I'd kill myself and save him the pleasure and practice!"* **Lennie Hyde, Law Enforcement Armorer, DC**

Still skeptical? Don't be! We at Tactical Response Solutions are putting all the risk on *our* shoulders so you don't have to worry about being disappointed. You see, we're willing to give you...

### **The Most Honorable Guarantee Possible: Take 3 months to decide!**

Simply stated, it's this: If you watch this video and you're not completely "blown away" by the martial arts system it teaches you...

If you practice the techniques you learn from Frank Cucci and **90 days later** you're *still* not convinced that the SEAL Team Unarmed Combat Course is one of the best systems you've ever seen *or* heard of...

...then I want you to stick the two video tapes and the Manual that comes with them *back* into the box and send everything back to Tactical Response Solutions for a full and complete refund of every penny you paid. No

questions asked, and no hard feelings either.

After all, *you* are the judge of whether or not the SEAL Team Unarmed Combat Course is right for you. A fighting system has to be personal and unique, and if this one doesn't fit into your style or psyche or whatever the case may be, we do not feel you should have to pay for something you can't use.

What can be more fair than that?

And of course, with a 3-month guarantee like ours, you have no reason *not* to at least give Frank Cucci's video a try.

Let me tell you: I've been training elite military soldiers, cops, and high-risk security agents for 24 years, and I've never been more impressed with a fighting method than I am with the SEAL Team Unarmed Combat Course. So I'm betting you *don't* ask for a refund.

But even so, you take *no risk* whatsoever. We want you to be completely satisfied, or you don't pay a dime.

I mentioned the Manual. Yes, there's a 48-page *illustrated* Manual that comes with the video package. Written by Frank, it walks you through his system and carefully explains every move, every principle of action, and even a few things *not* to do.

I think you'll find it indispensable. I sure did.

### Order now and get a FREE Special Report on "Hand-Launched Weapons"!

Plus, if you order Frank's video within the next 10 days, we will also send you *free of charge* a brand-new Special Report I've written. It's all about "Hand-Launched Weapons" and it teaches you an incredibly powerful "throwing" technique that turns virtually any object into a lethal projectile!

You know, these days you have to be pre-

pared for *anything* to happen at *any* moment. You can be caught off guard and forced to defend your life (or someone else's life) when you least expect it.

In situations like that, *the element of surprise* is the key to victory. Combine that with the ability to take anything within arm's reach and *naïl* your opponent from up to 16 feet away, and you'll never have to fear a hostile situation again!

I've taught this technique to SpecOp soldiers, federal agents, undercover drug agents, and high-risk bodyguards — who are often restricted by circumstances from using their guns, but need a reliable way to drop a man in his tracks at a distance. And it works every time.

For the average person on the streets who doesn't carry a gun, this Special Report is worth its weight in gold. But it's yours **FREE** when you order Frank Cucci's video!

So I won't say another word. Pick up the phone right now and call this number...

## 1-800-899-8153

(Ask for Dept. 18-C)

Have your VISA or MasterCard ready and ask for Frank Cucci's video, "**The SEAL Team Unarmed Combat Course.**" The price for everything — two hours worth of video tapes and the 48-page illustrated Training Manual — is only \$97. Period. You don't even pay the regular shipping charge. We pay it for you.

The video is shipped out the very next day after we receive your order. If you're in a hurry, we can ship by 2-Day Air for \$4 extra, or even Overnight Express for \$15 extra.

Either way, you'll have it in your hands a

few days from now, and you'll be able to possess the most powerful self-defense skills known to man — just like the SEALs do!

### Fight Like a SEAL!

Due to their elite training, Navy SEALs **rightly** feel they're something special ... like they can do anything in the world — and they practically *can!*

After you're trained by SEAL Team member Frank Cucci, there's a strong possibility that *you'll* have that same feeling. That same "fire in the gut" that makes a SEAL what he is.

I can't promise you'll be penetrating Saddam Hussein's headquarters next month, but I know you'll be more confident than ever of winning a fight on the street ... and helping your loved ones escape unharmed.

One thing I've noticed about the SEALs: "Quit" is not a part of their vocabulary. Nor is "fear." And after mastering this system, you probably won't use those words anymore, either.

It takes a special set of skills to be a SEAL. If you watch this video and practice the fighting system it teaches you, you'll have the same skills they have.

And when the day comes that you have to use them, you'll be a hero in *everyone's* eyes. But especially your own.

Order your copy **today.**

Sincerely,

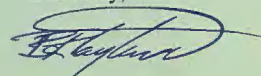

Bob Taylor,

P.S. I don't think I need to remind you: **IT'S A JUNGLE OUT THERE!**

But now, for the first time ever, civilians can learn to defend themselves as effectively as if they had been trained for *actual* jungle warfare — **straight from a Navy SEAL!**

With Frank Cucci's video, you'll learn the exact same hand-to-hand combat system used by the Navy SEALs — the most elite, most effective fighting unit in the U.S. military. This system is amazingly simple and easy to learn, and it will make you *invincible* if you are ever attacked or assaulted by "hostile forces."

Order Frank's video today and take **THREE MONTHS** to decide if it's really right for you or not. If it's not, you can get 100% of your money back — no questions asked. **Plus you get to keep the Free Special Report on Hand-Launched Weapons**, even if you ask for a refund.

We can't be any fairer than that — and you won't find a more *powerful* fighting system than this one used by the Navy SEALs.

## Use it...and WIN!

For The Fastest Service Use Your Credit Card And Call Toll-FREE

### 1-800-899-8153 (Ask For Department 18-C)

#### Priority Order Form For **SOLDIER OF FORTUNE** Readers Only!

**YES!** I have decided that I want to push my fighting ability as far as it can go—therefore, please **RUSH** me the Frank Cucci video tape-plus-manual package, "**SEAL Team Unarmed Combat Course.**" I understand this package will teach me everything I need to know to master this super-effective fighting style. I also understand that I have a completely "No-Hassle" No-Risk Money-Back Guarantee.

➔ By initialing this line, I am stating that I am over 18 years of age and that I have never been convicted of a felony. I also state that I will use the information contained in this video package in a defensive situation only. I accept sole responsibility for my actions as an adult.

I prefer to pay by credit card. Please charge me:  
 Visa  MasterCard  
 American Express  Discover

Enclosed is my check (payable to TRS) for \$97.  
Please rush my materials to:

Card #: \_\_\_\_\_

Name: \_\_\_\_\_

Expires: \_\_\_\_\_

Address: \_\_\_\_\_

Signature \_\_\_\_\_ City: \_\_\_\_\_ ST: \_\_\_\_\_ Zip: \_\_\_\_\_

**Tactical Response Solutions • 2945 S. Mooney Blvd. Dept. 18-C • Visalia, CA 93277**

CA & VA residents add appropriate sales tax. Rush shipping available for additional charges of \$4 for "2-Day" shipping and \$15 for "Overnight" shipping.

# SLICK WILLIE WATCH



## RECYCLING THE REJECTS

We overheard two men grousing about Clinton's circle of advisers being made up of "recycled commie rejects," which received a lukewarm challenge to "name some." The response was "Hell, they *all* are." We rather favor this kind of insightful, penetrating political discussion.

But in case you feel the urge to appear erudite next time the subject comes up and want to name one:

*Dr. Quentin David Young, 72, was recruited by Mrs. Bill Clinton as an adviser for her rejected*

health care scheme (while she disdained help from the American Medical Association). Young's support of communist causes dates back to 1954, when he wrote a pamphlet claiming the United States was using germ warfare in Korea, for the American Peace Crusade (identified in Congressional testimony as a communist front organization). Noted author Joseph C. Goulden in his 1982 book *Korea: The Untold Story of the War*. "POWs were tortured into making false confessions that they engaged in germ warfare. Any person who helped spread this lie is beneath

the contempt of decent people."

In 1952 Young signed an open letter to Truman asking a presidential pardon for convicted Soviet spies Julius and Ethel Rosenberg. The letter was published under the auspices of "The National Committee to Secure Justice for the Rosenbergs and Morton Sobell," cited by the House Un-American Activities Committee as a communist front. In 1966 the *Chicago Tribune* reported Young joined an *amicus curiae* brief prepared by the National Lawyers Guild, a CPUSA front group, to try to overturn the Internal Security Act

of 1950, which defined the CPUSA as being under Soviet control [Soviet archives released after the collapse of the Soviet Union show that Moscow was giving the CPUSA millions of dollars annually, and dictating its policy].

In July 1967 Young was a featured speaker at the "Radical Education Project" sponsored by the Students for Democratic Action (SDS) in Ann Arbor, Michigan, which brought Congressional investigators again knocking on his door. Another participant in the SDS seminar — Heather Tobias Booth — also served



## BlackHawk Industries Quality From Experience



**Long Gun  
Pack Mat**



**SPEC-OPS  
Holster & Mag Pouch**



**Modular Mesh  
Vest**

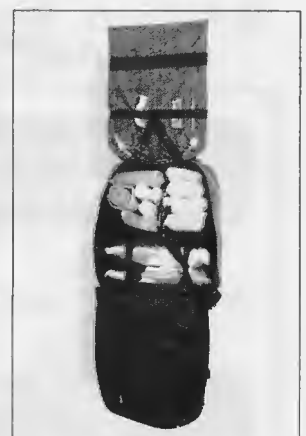

**SPEC-OPS  
Medical Back Pack**

BlackHawk is a unique company, owned and operated by a Navy SEAL. We offer state-of-the-art designs and quality for vests, harnesses, back packs, bags and pouches. All BlackHawk products are guaranteed for life!

Dealer inquiries welcome



**BlackHawk Industries, Inc.**  
2413 Bowland Pkwy, Suite 102  
Virginia Beach, VA 23454

(804) 486-8254 FAX (804) 486-8286

Contact your nearest dealer  
or send \$3.00 for our new  
complete photograph catalog



on Billary's health plan task force.

In October 1968 Young was subpoenaed for Congressional hearings investigating the riots and violent demonstrations at the Democratic National Convention in Chicago: Investigators queried Young about his Communist Party USA membership, his attendance at closed communist party meetings in 1948, and about an escrow account from which he supplied funds to the New Mobilization Committee (which directed the violence at the convention), with cash to rent its office some three months before the riots erupted.

In May 1979 Young joined with strategists from the radical-left Institute for Policy Studies to found the Citizens Party, which ran socialist Barry Commoner for president. In

June 1981, Young served as master of ceremonies for a "No More Witch Hunts" program in Chicago directed against FBI's counterintelligence program, contemporaneous with other protests staged by CPUSA fronts in other major cities. Well, so what?

The bottom line is, Young has long been an advocate of socialized medicine in particular, which critics agree was the hidden agenda behind Clinton's "reform" plan. And if you want to see what an utter failure communism, and socialized medicine in particular, is, look to the champions and pioneers — role models for people like Young and evidently Billary as well — in the former Soviet Union. And when you look, look to the folks who were on the receiving end of it. At least the American robber

barons deliver good medicine. Like everything else under communism all the folks (as opposed to the *nomenclatura* and party members) got a uniform low-level of hard to access and mediocre medicine, considerably less than what the indigent get from charity here. It seems the tired old communist "everybody except the elite gets the same and it's all crap" outlook still pervades the far-left luminaries and lunatics of the Clinton administration.

### PERJURY INVESTIGATION DEMANDED

Republican congressmen are demanding a perjury investigation of Deputy Secretary of State Strobe Talbot for denying his reported comments to a U.N. official, that President Clinton intended to invade Haiti for "political reasons." Talbot's denial

is contradicted by both the U.N. official, Dante Caputo, and by statements made by a National Security Council member at a Congressional briefing. Rep. Curt Weldon (R-Pa.) declared, "What this leads to is a simple conclusion: Someone is lying ... and that lying has allowed us to put our troops in harm's way, and we have got to get to the bottom of what our real motives are."

### SECRETARY OF AGRICULTURE PLOWED UNDER

After Attorney General Janet Reno urged the appointment of another independent counsel to weigh the trespasses of Clinton's Secretary of Agriculture Mike Espy, Espy resigned. At issue was his alleged relationship with Arkansas chicken plucker Tyson Foods. ✕

**"Special Purchase Allows Price Breakthrough"**

**Catalog \$4<sup>00</sup>  
Product Video \$10<sup>00</sup>**

## The Leader In Technology for Seeing, Sighting, Photographing and Video Taping In The Dark

### NIGHT VISION WEAPON SIGHTS

I GEN.  
**AN/PVS-2B Weapon Sight**

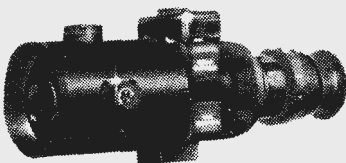

II & III GEN.\*  
**AN/PVS-4  
Weapon Sight**  
**\$2850<sup>00</sup>**

• Photo/Video Adapter Included  
• New with Excellent Cond. Intensifier  
\*III Gen. POR



**\$1695<sup>00</sup>**

• Includes Weapon Mounting &  
Photo/Video Adapter.

### POCKETSCOPE

II & III GEN.\*  
**NIGHT EXPLORER**

• Photo/Video Adapter Included  
• New with Excellent Cond. Intensifier  
• A Choice of Two Lenses from  
1X, 2X or 3X \* III Gen. P.O.R.

Grade I **\$1550<sup>00</sup>**  
Grade 2 **\$1350<sup>00</sup>**



### NIGHT VISION GOGGLES

II GEN.  
**NVG-500**

**Starlight Goggles**

• Includes: Cold Weather Heaters  
• Excellent Cond.

Grade I **\$2450<sup>00</sup>**  
Grade 2 **\$2250<sup>00</sup>**

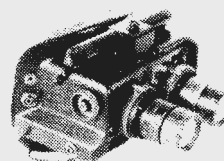

II GEN.  
**SC/PVS-700  
Mono-Tube Goggle**

**\$2295<sup>00</sup>**

• Excellent Cond.  
• 2X & 3X Lens Included

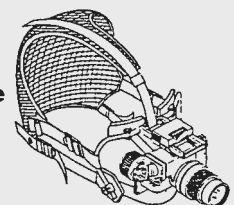

III GEN.  
**AN/PVS-7B  
Mono-Tube Goggle**

• 3X Add-on Available

**\$4500<sup>00</sup>**  
(New - Standard)

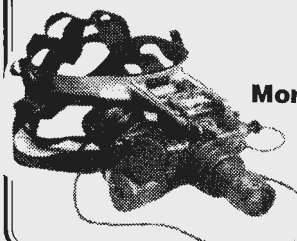

## STANO Components

P.O. Box 2048 • Carson City, Nevada 89702 • (702) 246-5281 / (702) 246-5283 / Fax (702) 246-5211

# EXTRAORDINARY SURVEILLANCE AND INVESTIGATION AIDS



## CONGRATULATIONS!

You've just found the best source for night vision scopes in the, well, hell, maybe the world.

The *American made* **LEOPARD** is a compact, rugged, handheld viewer—the smallest unit of its kind in the entire world. Utilizing 3rd generation technology, the **LEOPARD** works like magic in adverse weather and moonless nights. The intensifier tube and optics are identical to that of the Anvis Aviator's Goggles (remember Desert Storm?). The **LEOPARD** takes common C-mount camera lenses, allowing almost any front-end configuration, (comes with 1X lens), including relays, doublers, and zooms.

Radical (optional) ocular relay allows direct operation with SLR and video cameras. Flip it around and *couple it to a rifle scope* or other device. Optional adapter allows use as single eye goggle. Even has a built-in IR illuminator and threaded rings on both ends...

Optional Weaver scope mount, or an invisible laser that throws an IR dot on your target that you can see and aim through the **LEOPARD**.

We've spent a year testing scopes. The **LEOPARD** is the best price/best scope/best deal we've found. Packed in a hard-shell foam lined case, all units come with a one year warranty (covers the tube).

- 2nd generation reconditioned \$1495
- 2nd generation new \$2450
- 3rd generation new (4 times as powerful, 4 times the tube life!) Only \$2995! Usually priced at about \$6,000, this is the hottest unit on the market.



## COUNTER SURVEILLANCE

**C3** This is the first (patented) unit that has ever, I mean ever, been able to find government, police, industrial spy, and top private detective taps on any phone line, from your phone through the phone company *Central Office!*

Finds slaves, bridges, loop extenders. Stuff *nobody* has ever before been able to prove lives on your line. C3 covers one phone line, and guarantees your on-going protection from these taps \$595.

**ATS** Automatic Tap Stopper. Stays on the line, defeats all X-phones, infinity transmitters, automatic recorder starters, parallel transmitters, many series transmitters. Peace of mind for \$495 Spy shops charge \$1,000 for similar units... And ours is better.



## COBRA III+ ELECTRONIC LOCK PICK \$499

Open 90%+ of all the locks  
in the world in 30 seconds or less!

The COBRA III+ is made by the inventor of electronic lock picks. Magic, it's just magic. Rechargeable hot packs, Halogen key-way light, aircraft aluminum construction, thin picks,



very powerful motor, rubber grips. The California state lock picking champion did 20 locks in 3-7 seconds each—on camera. **Buy the COBRA or any other lock pick from us, mention this ad, & get our \$59.95 Video Tape "Superpicking" for half price!**

The best thru-wall mic in the world? Our SuperMic kit consists of a super high gain, low noise amplifier, contact microphone (which translates minute wall vibrations into audio), a sensitive electret mic element with two screw-on spikes that hear virtually any sound through tiny cracks or pin holes, and an amazing transparent accelerometer that turns any window into a giant microphone. The SuperMic lets you find all possible attack points in a "secure" room. Not designed or intended for unauthorized, surreptitious eavesdropping through building, apartment, condo, or hotel walls—\$599

A Professional ELECTRONIC TRACKERS, \$3,000. SOLD BY OTHER DEALERS FOR \$6K! The best telephone recorder starter EVER ("The Mother") —\$75.

Best books, newest videos, hottest equipment... Our new catalog \$15—free with any purchase. If you have a specific question, please FAX us at 415-851-5403 or write via a government agency —the postal service.

**CHECK OR MONEY ORDER TO:  
INTELLIGENCE INCORPORATED  
2228 S EL CAMINO, #349 D  
SAN MATEO, CA 94403**

+ \$5 shipping. CA residents include 8% tax.  
(Checks held for clearance.)

**INTELLIGENCE  
INCORPORATED**



## BETTER DEAD THAN DISARMED

Though a reader of *SOF* for many years, I have never been motivated enough to write in and state some facts. First, anyone who buries their weapons is a stone-cold coward. This is not what the home of the

dignified, honorable death instead of living the life of a coward slave. 'Nuff said.

Marty B.  
Houston, Texas

## ... BUT DON'T DIE IN VAIN

A recent phone conversation with a friend revealed a disturbing fire-

FBI/U.S. Marshal complex is counting on. Their strategy will be to divide and conquer. They can and will prevail when confronted with single individuals or small, untrained groups in a standoff.

2. A patriot's life is much too valuable to waste in such an admirable, but ill-conceived fashion. If the "crunch" actually comes, we will need every pair of hands dedicated to a common, well-planned campaign. Federally assisted suicide is not the answer.

3. The most basic precept of any individual or group engaging a numerically superior force is "never defend ground." Do not let them contain

you on any one piece of real estate. Hit and run. Read Sun Tzu.

4. It should not need reiteration, but obviously does, that organizing, training and pre-storage of supplies are keys to restoring government and the Constitution to our country. Our country, not theirs ...

"Christopher Jedburgh"  
Tucson, Arizona

## LEGAL HELL-FIRE

It is with deepest regrets that I must withdraw my advertising. I am forced to seek bankruptcy

protection to avoid costly litigation from a lawsuit being brought against Orpheus/Hell-Fire by the survivors of the massacre in San Francisco where a deranged individual shot up a downtown law office.

The lawsuit seeks compensatory and punitive damages claiming that our products were used by this deranged individual in the massacre.

Closing the doors and putting the business into bankruptcy was the only way the company could avoid the ruinous cost of defending the product in court.

Even though the product was in no way responsible for the actions of the deranged person, we are being made to pay just to defend our right to exist. This is another sad day for the American free enterprise system.

Lester Menica,  
President  
Vincent Troncoso,  
Inventor  
Hell-Fire Systems Inc.  
Olathe, Colorado

## SF MISSIONS IN AMERICA

Enclosed is a self-addressed stamped envelope. Please send me a copy of "The Resister."

As ex-SF, it does my heart good to know that should things fall apart, and I think they already are, SF may end up doing what they were created for in the first place — training the populace against a tyrannical gov-



brave and land of the free is all about. It is about a two-century-plus struggle to remain free men and women at any cost.

Had our forefathers said, "The British are coming, let's bury our muskets," instead of "The British are coming, let's kick some ass!" we would still be living under British tyranny. I'm 32 years old and have served in the U.S. Army infantry, and for me, there is no option but freedom. Don't get me wrong, I enjoy life as much as any, but if the time ever comes, I will die a

arms owner mind-set which I have heard repeated, with minor variations, from many others: "If they ever come to get my guns, I'll sandbag my interior walls and give them everything I can until they get me. They may end up with my weapons, but I won't be alive to see it, and neither will some of them."

It took a determined and lengthy argument to change his mind, during which I brought forth the following facts:

1. Such an action is exactly what the BATF/

ernment. Glad to hear the troops haven't bought the socialist lies coming out of the Red, oops, I mean White House.

M.A.  
Lancaster,  
Pennsylvania

*The number of requests for The Resister far exceeded our expectations. We've sent out more than 1,000 so far. For the next issue you're on your own.*

**AN ATROCITY  
A DAY ...**

A recent news item *SOF* seemingly overlooked was the court-martial of several Canadian Paras for the brutal beating death of a Somali civilian during the Canadian Airborne Regiment's tour as peacekeepers in Somalia.

Not that I am condoning or advocating this sort

of action, but did anyone notice that no canuck peacekeeper was ever beaten and dragged half-naked through Mogadishu by a Ray-Ban mob? Sort of reminds me of Lebanon in 1983. The Marines who did it by the book, down to carrying empty-chambered rifles, were bombed. So were some French troops. But the Foreign Legion, with its history of not shying away from an occasional atrocity against "civilians," was left completely unmolested. Kind of makes you wonder, doesn't it?

J. P.  
Fernandez  
Albertson, NY

**WELCOME  
TO SPYMART**

I recently went into a WalMart store here in Texas to purchase 400

was intended for a handgun or rifle so that she could plug the information into her computer. I told her "It's not yours,



rounds of .22 long rifle ammunition for target plinking. After arriving at check-out, the cashier

WalMart's or the Clinton government's business what the hell I am going to shoot these from." I trust all shooters will do

# BENCHMADE



NOW YOU HAVE A CHOICE BETWEEN BENCHMADE'S TWO NEWEST HIGH TECH TACTICAL FOLDING KNIVES. FEATURING TITANIUM LINERS, G10 HIGH PRESSURE LAMINATE SCALES AND ATS34 BLADE STEEL.

DEMAND THE BEST !  
DEMAND BENCHMADE !

**MADE IN  
USA**

**BENCHMADE**

FOR A COMPLETE BENCHMADE PRODUCT BROCHURE SEND \$2.00 (SHIPPING AND HANDLING) TO:  
BENCHMADE KNIFE COMPANY INC.  
15875-G S.E. 114TH AVE.  
DEPT. S-F  
CLACKAMAS, OREGON 97015 U.S.A.  
OR CALL 503-655-6004

\*MODEL 800 MADE IN THE U.S.A. BY BENCHMADE KNIFE COMPANY UNDER LICENSING AGREEMENT WITH SPYDERCO® INC.



# EDGED TOOLS

## FOR THE ACTIVE MAN Street Fighter I

### Vietnam Tomahawk

**MADE FOR MILITARY USE**

13-3/4" overall length. 8-1/2" hawk length with 2-3/4" cutting edge and a 3" spike that can penetrate a 2x4. Straight grain hickory handle. Complete with leather sheath. Approximate weight 1 lb. A true collector's item... don't let this one pass you by!

ORDER NO. TC-200

Limited Offer!

Bud K. Price \$18.95

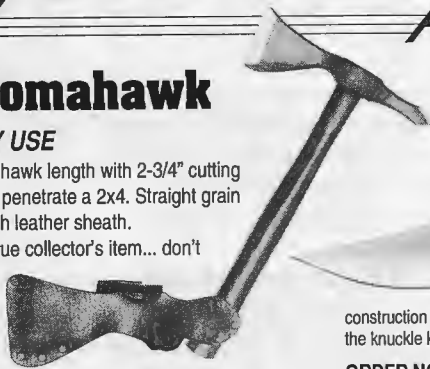

In your hand extends 10" of razor sharp stainless steel. With your fingers thru the stainless knuckleguard and wrapped around the ebony pakkawood handle, you will be amazed at the power one knife can have. Full tang construction assures performance when other knives may fail. Over 15" long, this knife has been called the knuckle knife of the 90's. Complete with top grain leather sheath with quick release velcro strap.

ORDER NO. D-9117 Retail \$95.00 Bud K. Price \$47.97

### CIA Gravity Knife

Exclusively designed by Bud K. This knife is lightning fast — with a push of a button, out slides a 3-1/4" heat-tempered stainless steel blade. Releasing the button locks the blade into position. 8" overall.

ORDER NO. D-500

Order Now...  
Limited Supply!

Bud K. Price \$17.95 or 2 for \$32.50



### Steel Batons Coiled & Ready to Strike

**Impact Baton** - Ejects with the snap of the wrist. 17 inches of 30-gauge steel. Re-sheaths instantly. Only 7" closed.

ORDER NO. 127 Bud K. Price \$13.95

**Automatic Baton** - 3 section steel baton extends from 6-1/2" to 20" with a push of a button. Comes with leather sheath with belt loop.

ORDER NO. 6553 Bud K. Price \$29.95



Back by Popular Demand...

### Butterfly Knives

According to U.S. Customs, Balisongs can no longer be imported, but Bud K takes up the slack with this well made butterfly knife. The blade is 4" long and when opened stretches to a whopping 9". The skeleton handle gives the knife a hi-tech look. CALL TODAY... At this low price, quantities will not last long.

Available in...

Chrome - ORDER NO. F5-C

Black - ORDER NO. F5

Retail \$19.95

Bud K. Price \$15.95 each



### Knife Buckles

The belt buckle with a surprise! The black casing houses a 3" edged dagger of 440 stainless steel. Blade can be quickly detached without loosening your belt. Front of buckle has a 2" square perfect for engraving your initials or any message. Ideal for self protection or small cutting jobs.

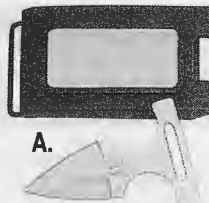

A.

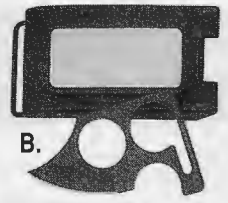

B.

Your Choice...

A. Double Edge Chrome - ORDER NO. BK-2

B. Black w/Finger Holes - ORDER NO. BK-5

Bud K. Price \$11.95 each

### CIA Sleeve Daggers

The Stingers fully sharpened double edge blade can give you the edge in any situation. The blades are of a diamond cross-section design with grooves in the base to provide gripping power for the thumb and forefinger. Perfectly balanced for handle or blade throwing. Sheath included. You will be amazed by the penetrating power of the stingers.

A. STINGER I - 7-7/8" length ORDER NO. D319

Bud K. Price \$7.95

B. STINGER II - 5-1/4" length ORDER NO. D320

Bud K. Price \$6.95 Order Both for \$13.95

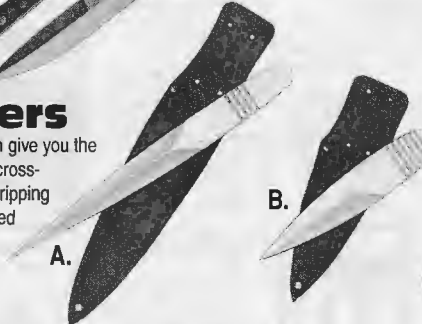

A.

B.

### THE VIPER COBRA I King Size

This new weapon is ready to strike two ways. Use the 10 terrible 3/4" long steel spikes that screw in and out for safety or the monster 8-1/2", 440 stainless steel blade with its deadly edge. Each cobra comes fitted in its own customized black leather sheath. Never before has such a vicious weapon been offered at such earth shattering prices! Call today - and we will smuggle to you this wicked weapon! 15" overall.

ORDER NO. BK-201

Bud K. Price \$79.95

VIPER COBRA II

Also available...a smaller version of the above. 11" overall.

ORDER NO. BK-200

Bud K. Price \$59.95



### HOW TO ORDER



Call Toll Free... 1-800-543-5061

Or Send Check or Money Order To:



WORLDWIDE, Inc.

P.O. Box 565, Dept. SF-4 • Moultrie, GA 31776

Add \$4.00 Shipping & Insurance or 5% of Total Order.

All products carry Bud K.'s 100% Satisfaction Guarantee.

Void in states where prohibited by law. Check Local Laws before ordering.

DEALER INQUIRIES INVITED

### FREE Knife Catalog

1000's of Quality Knives & Survival Tools to choose from... all at Bud K.'s guaranteed lowest prices.

**Yes!** Please send me the free Bud K Catalog!



Name \_\_\_\_\_

Address \_\_\_\_\_

City \_\_\_\_\_

State / Zip \_\_\_\_\_

Clip Coupon and mail to address above.

CODE #SF-4

the same when confronted with that question.

I wonder what she would have asked me if I'd been buying condoms.

Mack H. Flanders,  
Lt., USN, (Ret.)  
Granbury, Texas

### TYRANNY OF THE MAJORITY

I love your mag but don't agree with RKB's October '94 "Command Guidance." If I am in an elevator with 10 people and six (a majority) vote to steal the guns of the next guy that comes in, does this make it right? Was slavery legal and moral until Congress outlawed it? By this logic if a confiscation ban passed by 51% (and everyone voted), I and others are then wrong if we don't turn in our weapons.

Your logic is understandable, but my libertarian thinking disagrees.

It will *not* be my fault if the BATF comes knocking. Tyranny is tyranny, and no one should have to vote to get the federal government off their ass.

Name withheld by request

### PC POWER SHIFT

As a 12-year veteran of the armed services I can attest to widespread dissatisfaction in the military. The most ominous aspect is that the more senior people are retiring or being forced to retire, leaving the younger generation (with a higher percentage of politically correct individuals) in power.

I understand that the old school must sooner or later be replaced, but the generation taking the watch has no fundamental understanding of freedom and the document they have sworn to up-

hold. This lack of knowledge, coupled with the politically correct education these youngsters have received, reminds me of the power shifts that have occurred in numerous nations in this century, none of which proved beneficial to those nations.

Dana Lee Kissick  
Sopchoppy, Florida

### WRONG ON RIGHTS

In the "Bulletin Board" section of the October '94 issue, an H. Byrd Mapoles, author of the Santa Rosa ordinance that made every able-bodied individual a member of the militia, is quoted as saying, "We believe we have certain rights given by the Constitution ..."

While I strongly agree with the ordinance, his rationale is flawed. Unfortunately, Mr. Mapoles is not alone in his well-meant, but flawed, under-

standing of the Bill of Rights. The Constitution does not *give* us any rights. The framers of the Constitution recognized that a free people are *endowed* with these rights. The Bill of Rights was written to prevent the government from infringing on these rights.

To state that the Constitution gives us these rights leads us to the dangerous assumption that it can eliminate them as well. This nuance must be understood and emphasized if we are to remain free.

Robert Polaneczky  
Oreland, Pennsylvania

### WRITE TO SOF

We invite reader comments: send letters to *SOF*, c/o FLAK, PO Box 693, Boulder, CO 80306. Due to limited space we reserve the right to edit for content and brevity. ✕

# Crown's DOWN & DIRTY BOOKS

#### SNIPER TRAINING & EMPLOYMENT

This sniper's bible is an excellent source of info for hunting, target and sniping work. Covers camouflage, shooting techniques, survival, and MORE! 168pp.

#SB899 \$11.95



#### COMBAT LOADS FOR THE SNIPER RIFLE

A long, hard look at what sniper loads can and cannot do. Includes penetration tests on trees, steel plates, cars, etc., reveal surprising results. Also includes designs & loading data. A must have! 156pp.

#GB123 \$12.95



#### RANGER TRAINING HANDBOOK

Official manual for the U.S. Army's Rangers. Covers guerrilla action, night operations, raids, intelligence, ambush, assault, hand-to-hand combat, and more! Very informative! Softcover, illus. 213pp.

#GB889 \$8.00



#### PRIVACY

The world's first guide to total personal privacy. How to get it. How to enjoy it. Avoid "big brother" and virtually "disappear." ALL the privacy you want and MORE! An absolute must have book!

#SB76 \$21.95



#### AK47 ASSAULT RIFLE

MAK-90 and all AK variants covered. Produced by the 203RD Military Intelligence Battalion. Very detailed, fully illustrated, and a must for any AK-type rifle owner.

#SB984 \$6.00

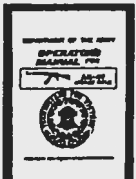

#### MAC-10, MAC-11 MANUAL

Every thing you've always wanted to know about the M-10 & M-11 but were afraid to ask! This is a very fine publication covering all aspects of these great weapons.

#SB625 \$9.95

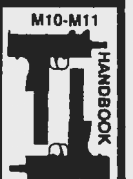

#### RUGER CARBINE COOKBOOK

This great book covers all facets of the Ruger 10-22 and the Mini-14. This comprehensive manual is a must have for owners of these popular rifles.

#SB117 \$7.95



#### THE SHOTGUN IN COMBAT

A one stop source for the use of the shotgun in a combat situation. This comprehensive book covers everything from home defense to night encounters!

#SB69 \$13.50



#### COLT .45 AUTO PISTOL

This technical manual covers nearly all facets of the .45 Auto Pistol including operation, parts, maintenance, tools, ammo, and much more. 64pp.

#SB162 \$6.95



#### SURVIVAL

This is probably the best survival manual we've seen. Covers all aspects of emergency and combat survival. An excellent source of information. Great addition to your library. Over 280 pages.

#SB893 \$9.95



#### AR-15/M-16 MANUAL

The new U.S. Marine Corps A-2 Manual for the Colt AR-15/M-16. Everything you need to know, this manual has it! Many illustrations and numbered parts. Over 200 pgs.

#SB885 \$9.95



#### GUERRILLA WAREFARE And Special Operations

Without a doubt one of the best books ever written on Guerrilla Warfare. The "Bible" of our elite Special Forces in its entirety. An indispensable volume! Over 250 pages.

#GB880 \$14.95



ORDERS ONLY CALL  
**1-800-239-7435**  
205-222-1931 / FAX 205-222-2309

SHIPPING & HANDLING  
ADD \$4.00 TO TOTAL

NOTE: Books are sold for entertainment purposes only. Books can be returned for same title only, if received defective.

CALL TOLL FREE TO ORDER  
OR SEND CHECK OR MONEY ORDER TO:  
**CROWN SPECIALTY CO.**  
DEPT. SF, P.O. BOX 488 • ANDALUSIA, AL 36420

**SOF T&E**

# SEAL's Attack Pack

Text & Photos  
by Peter G. Kokalis



The unique Mesh Back Attack Pack is ideal for day hikes, short overnight trips and both military and law enforcement special operations.

**The first backpack** was an open basket made of woven splints of wood with attached shoulder straps — a device used for centuries by woodsmen in the Adirondack Mountains of New York and throughout the New England states. It was usually used in conjunction with a tumpline — a wide leather headband with trailing leather straps that could

be looped around almost any man-sized load. Both the pack basket and tumpline probably originated with the American Indian.

This was followed by the Duluth rucksack, the Norwegian Bergan pack — favored for many years by the British SAS — and wood or metal packboards of the type used by the U.S. Army during World War II. When I started backpacking in the Grand Canyon 30 years ago, external-frame-type packs, such as the Kelty or Camp Trails were very popular.

But external-frame packs rest too high above the hiker and tend to be top heavy. This is potentially dangerous when you leave a well-developed trail and hike cross-country up and down talus slopes. In addition, as you walk this type of pack will cause the load to shift slightly from side to side with each step.

Backpacking equipment has changed radically within the last decade. So-called internal-frame packs now dominate, and highly sophisticated gear of this type has been developed for military and law enforcement special operations groups. The first internal-frame pack was little more than a rucksack with an internal metal frame and spine pad. This geometry provides a lower center of gravity, and the shoulder cradle system and waist belt used on these types of packs aid to pull the pack close to the wearer's back. The shoulder straps serve only to keep the pack from falling off the back as the full weight of the pack is supported by the hip belt and spine pad.

The most intriguing internal-frame day pack that I have ever come across is the Mesh Back Attack Pack, designed and produced by The Wilderness (Dept. SOF, Suite 7, 5130 N. 19th Ave., Phoenix, AZ 85015; phone: 800-775-5650 or 602-242-4945, fax: 602-242-3999), already well known for their unique Safepacker holsters. Fabricated from sun and rot resistant, black-coated polyester mesh (originally designed for outdoor furniture), this pack was developed with a most peculiar salient feature: Water flows in and out of the pack easily. If required, an air-evacuated dry bag can be inserted into the pack to keep equipment dry. Obviously intended for possible applications with units like the U.S. Navy SEALs, this unusual backpack has also been made



A hidden pocket behind the lower exterior compartment on the pack's front panel provides for storage of a handgun, in this instance an S&W M629 .44 Magnum Mountain Gun. A Cordura envelope inside the handgun pocket conceals the weapon's presence.

from orange mesh and sold to water rescue teams. As an additional benefit of the mesh construction, it should be noted that wet clothing put into the pack will dry quickly.

The Mesh Back Attack Pack has a black, reticulated foam backing, which also drains water quickly and is completely removable by means of a center zipper in the back panel. During wear, the reticulated-foam back permits air to

Continued on page 58



Four-way lash pads sewn to the stay pockets permit gear, such as a rain poncho, air mattress and bivouac sack to be stowed in a tier-like manner. This layering of equipment helps to concentrate the load on the hip belt instead of the shoulder straps. Note military canteen attached to the left side of the pack by means of a Safepacker keeper.



## SOF On The Ground In Port-au-Prince

# HIGH NOON IN HAITI

by Dale B. Cooper  
Photos by Peter Noble

**Private First Class Sean Smith** stood guard in Port-au-Prince, looking down on a crowd of 60 to 70 exuberant Haitians who had gathered beneath his sentry post, when a pickup loaded with heavily armed Haitian “riot police” screeched to a halt. Before they could dismount and begin beating the civilians, Smith grabbed his SAW. For what seemed like an eternity, the lone soldier stood his ground, outgunned 12 to one. Finally, the Haitian NCOIC blinked and ordered his driver to back up and leave. Smith, whose orders did not authorize him to intervene, later said he would have opened fire if the police had made a threatening move. Unknown to Smith, the rules of engagement were being modified during his showdown.



The 82nd's secret landing plan, had invasion been necessary, involved 46 C-141s and 68 C-130s from the Air Force, 65 choppers from Army aviation, 465 wheeled vehicles, 58 pieces of track-laying armor, six M119 howitzers and more than 7,000 troops: 3,331 airland, 2,852 airdrop and 864 airdrop/airland.

The order to launch the invasion of Haiti had gone out from the Pentagon at 1745 18 September 1994, to Fort Bragg, home of the 82nd Airborne Division — the “All Americans.” The mission was straightforward: *Neutralize* Haitian armed forces and police, *protect* American citizens/interests and foreign nationals, and *establish* lodgements in order to set the conditions for the return of the democratically elected leader to Haiti.

The order to remove the military junta, which had been ruling Haiti since forcing duly elected President Jean-Bertrand Aristide from power



three years ago, went forth while a high-level U.S. delegation headed by former President Jimmy Carter was trying desperately to convince Lieutenant General Raoul Cedras and two other members of the ruling junta to step down.

Most of the 2,760 paratroopers were unaware of the game of “blinkmanship” being played by Cedras and Carter as their air armada of more than 60 USAF C-130s and C-141s headed across the moonlit Caribbean to drop zones at the airport near the capital of Port-au-Prince, a city of some 1,200,000,



**Haitian arrested during raid on FRAPH house in Port-au-Prince 3 October 1993, when Army authorities took over the HQ of the Front for the Advancement and Progress of Haiti, in hopes of disarming opponents of exiled President Aristide. Photo: AP/Wide World/John Gaps III**

and nearby drop zone Pegasus.

The initial airborne assault was designed to quickly place overwhelming combat power on the ground. Division Commander Major General William M. Steele had received the initial planning directive from the XVIII Airborne Corps in July 1993,

and more than a year of planning went into the 82nd's most complex airborne mission since Operation Market Garden in September, 1944. The thought of making history was probably lost on the paratroopers whose grandfathers jumped with the 82nd a half century ago: They were mainly concerned with surviving a 500-foot night combat jump.

Every training event for the past year had been designed to prepare the division, and particularly the aviation brigade, for combat helicopter assaults to be conducted within minutes after the first soldier parachuted

into Pegasus. Multi-ship overwater flights with night vision equipment prepared the brigade for deployment from the continental United States through Homestead Air Force Base, Florida, to Greater Inagua Island and finally the air assault into Pegasus.

Prep fire and close air support were to be provided by F-16 Fighting Falcons and A-10 Thunderbolt IIs from Air Combat Command's 23rd wing out of Pope Air Force Base. AC-130 Spectre gunships would provide SpecOps with accurate 20mm, 40mm and 105mm fire. Naval and Marine gunfire would also be used to prep



On D-plus-three, half a dozen SF A-Teams and one B-Team choppered into Camp d'Application, the Haitian army training center and home of the 27th Heavy Weapons Company near Port-au-Prince, and secured ordnance stores varying from cans of black powder, to crew-served weapons, to antique artillery, to modern light armor.

the DZ. Nothing was left to chance. Using sophisticated intelligence systems, planners put together comprehensive target folders, even updating the intelligence picture while the 82nd Airborne Division was on the way.

At about 1730, I sensed something was about to happen when Ambassador William Swing jumped into his limousine and bodyguards piled into their Chevy Suburbans parked at Port-au-Prince International Airport. The small convoy sped away toward the National Palace where Carter and two members of his team, former Joint Chiefs Chairman General Colin Powell, and Sam Nunn, chairman of the Senate Armed Services Committee, were presenting a "take it or leave it" agreement to have Cedras and his cronies step down on 15 October.

The Carter delegation had just come from the general's home where Mrs. Cedras told Carter she knew that she and her three children — a 17-year-old son, a 14-year-old daughter and a 10-year-old son — had been targeted by U.S. SpecOps. "We will die before we leave Haiti," said the general's wife. When she finished discussing the death pact, Carter was stunned. He thought his mission had failed.

So did President Clinton. Several hours had passed since Clinton had

given Carter a noon deadline to conclude the agreement. Reporters who caught a glimpse of Clinton at the White House say he was perspiring heavily. As the session continued in suburban Port-au-Prince, a secure telephone in the next room rang. It was Clinton. An aide to the Carter team took the call. Clinton wanted to speak to anyone on the team and tell them that they had 30 minutes to wrap up the deal, or he was going to order them to leave Haiti.

### The Mouse Postures And Roars

Powell left the room for a 20-minute conversation with Clinton. His absence appeared to rattle Cedras, who paced back and forth like a caged animal. "It was apparent to me that Cedras was relying on Powell to convince his wife that it was not the duty of the general and his family to die," observed Nunn.

Just when it looked like Cedras was going to blink, Haitian army chief of staff, Brigadier General Phillippe Biamby burst into the room, accusing the Carter team of trying to trick them into surrendering power with talk of an imminent invasion. Powell told Biamby that if he had any contacts in the States, he should call them at once and verify the situation: When Biamby returned, he told Cedras he had received a fax and two phone calls confirming the 82nd had taken off from Fort Bragg. Biamby then accused the Carter team of negotiating in bad faith — merely keeping him and other military leaders away from their posts in the face of an invasion. Had negotiations at the palace gone sour, Delta Force troopers were on standby on the carrier *America* to effect an extraction of the U.S. negotiators.

It wasn't until Cedras told Powell he would honor the agreement that Carter called Clinton, and the president turned the 82nd around in mid-air, 73 minutes out. The jumpmaster on the 7th aircraft broke a Chem-

Stick and wrote a simple message in phosphorescent green on a chalkboard so that everyone could see: "GOING HOME."

At 0930 the day after the invasion was called off, troops of the 10th Mountain Division from Fort Drum, New York, choppered into Port-au-Prince International Airport, in 10 Army Blackhawks, preceded by Cobra gunships from the carrier USS *Eisenhower*.

The first soldiers to leap from the Blackhawks belonged to Company C, 2nd of the 22nd. They formed a defensive perimeter as the Blackhawks lifted off. But since the only people "firing" at them were photographers armed with 35mm cameras, Charlie Company jumped to its feet and scurried across the concrete.



Troopers of the 82nd Airborne embark on the biggest jump since World War II — but were recalled 73 minutes out, two hours from the DZ. Recall was met with mixed emotions. Photo: Ft. Bragg PAO

A few veterans of America's ill-fated mission to Somalia said they didn't know what to expect. "We were told we might be fired on by snipers," said one trooper. But no shots were fired in anger by either side. Just like Somalia, the landing was unopposed. But the climate soon began to change.

A Haitian man selling gasoline in the port area was beaten to death by Haitian riot police. Hundreds of other



Haitian heavy weapons sequestered by U.S. troops included an eclectic mix of World War II U.S. 37mm and 57mm AT guns, 75mm and 105mm howitzers, Combloc artillery, 57mm and 106mm recoilless rifles, 60mm and 81mm mortars, aging U.S.-made Bofors 40mm AA guns, and some V-150 armored cars.

civilians who had come down to the harbor to watch the first American convoy leave the docks were clubbed by Haitian police. I watched as a man's head was split open like a watermelon with a club the size of a Louisville Slugger. The victim had been walking near the water's edge when four Haitian riot police singled him out at random and beat him within full view of U.S. troops: Our rules of engagement forbade them to intervene.

After watching helplessly from his perch atop the concrete wall that surrounds the port, one 10th Mountain trooper indicated enough was enough. "If we don't do something to stop this," said the soldier, "I'm going to throw down my gear and walk to the Dominican Republic." By sunset on D-plus-two, there was rebellion in the ranks. Privates were begging com-



GIs with M16A2s and M203 grenade launchers, backed by troops in a Bradley fighting vehicle, watch the collection of heavy weapons from Haitian military.

pany commanders to let them come down off their sentry posts and prevent further bloodshed. But the official word from the White House and Pentagon was "U.S. troops are not going to get involved in day-to-day law enforcement in Haiti."

D-plus-three dawned with more police brutality and intimidation. Later that day, Lt. Gen. Hugh Shelton, the jut-jawed commander of the Joint Task Force, told Cedras that U.S. forces would not tolerate any further beatings of civilians. The new rules gave U.S. troops permission to use deadly force if necessary to protect Haitian lives.

### Pulling The Teeth Of A Paper Tiger

Camp d'Application, the Haitian army's training center and home of the 27th Heavy Weapons Company, was a prime, and perhaps the most feared, target before the invasion of Haiti had been called off. Located in the hills about seven miles from Port-au-Prince, the camp contained everything from Cadillac Gauge V-150 armored vehicles to 40mm anti-aircraft and 57mm anti-tank guns, plus an assortment of machine guns, assault rifles, and stockpiles of ammunition.

At sundown on D-plus-three, six SF A-teams and one B-team helicoptered into the compound while dumbfounded Haitian guards stood at the main gate and stared skyward. Under command of Major James Nelson, the SF troopers began to account for and inventory all weapons and ammunition. "We got everything," proclaimed Brig. Gen. Dick Potter, deputy commander of the U.S. Army's Special Operations Command, as he arrived the following morning to inspect the weaponry. "We had only one surprise," Potter said as he walked toward the barracks where Haitian soldiers were lugging out ordnance.

"Intel told us the Haitians had 57mm anti-aircraft," Potter said, "But in fact it was 57mm anti-tank." Most of the stuff I saw was in poor condition: 16-round cans of 40mm ammo were badly corroded. Some of the belted 12.7mm ammunition was in similar condition. Aging pineapple grenades bore a 1953 manufacture date — but they were still lethal. A grenade hurled a week later near city hall killed five Hai-

tians and wounded 47 others.

When Nelson's men air-assaulted into the compound, they found one of the 40mm Bofors locked and loaded. "If this had been a hot LZ," Potter said, "The Haitians would have been able to get off a four-round magazine before Spectre obliterated the gun crew." Potter's SpecOps personnel were prepared to hit Camp d'Application with so much firepower that the compound would still be smoking.

Heavy weapons like armor and artillery were lined up on a soccer field for the media to film. One 57mm mountain gun bore a bronze manufacture plate "February 25, 1909" — but the weapon was still in firing condition. Bradleys from the 24th Mech, veterans of the Gulf War, dragged the



Some of the very miscellaneous weapons confiscated included vintage 20mm Oerlikon AA guns, FAL rifles, rotting spares for M60s — even a GOEC 37mm flare gun.

V-150s and artillery to the airport to be guarded. Crowds of Haitians cheered as the ordnance was dragged out the iron gate, past a mural proclaiming "Honneur, Discipline, Competence."

### Non-Battle Fatigue

How close did the Haitian junta come to being hosts of an invasion? The lead aircraft in the string of C-130s and C-141s that stretched for almost a hundred miles in the skies over the Caribbean was only *two hours* from the DZ.

A week after the "friendly invasion" at the airport, I flew back to the States with Lieutenant Colonel Cliff Bray, commanding officer of the 18th Airlift Squadron at McGuire Air Force Base, New Jersey. As the chief mission commander of the C-130s and C-141s, Bray would have orchestrated

Continued on page 64

# One if by Law, Two if by Decree

# Clinton's Covert Gun Control

by *SOF Staff*



**Bill Clinton** brought home from Oxford the bygone notion that a social contract exists between ordinary men and modern government very similar to the relationship between English feudal lords and serfs. Atrocities to freedom, such as the Crime Bill, are based on the premise that citizens will gladly subordinate personal liberties if they are promised government protection from banditry. The reality, however, is that such a union between government and its citizenry was resoundingly rejected by Americans quite some time ago — on a spring day in 1775 at a bridge north of Concord, Massachusetts.

The Clintons arrived in Washington mindful of the idea that when confronted directly, Americans might be a bit reluctant to give up their personal freedoms in exchange for a promise that the government will protect them. For more than a decade

opinion polls conducted by the government, various think tanks and news organizations have consistently shown that a majority of Americans endorse private ownership of firearms.

The Clinton view of public policy does not have room for such populist sentiments, arguing that Americans only feel that way because they don't know any better. Clearly the common man isn't capable of making the decisions necessary to safely negotiate his path through life. Therefore, the government needs to protect its subjects from themselves. And the Clintons put into place a strategy to quietly remove as many firearms as possible from the reach of the common man.

The most obvious part of this strategy was to fight gun ownership in the proper forum — legislatively on Capitol Hill. Hand Gun Control Inc. and other anti-gun organizations had

**With a president like Clinton, who needs Congress. By circumventing the legislative branch and coercing the Treasury Department to follow along, president has ratified a de facto gun ban on imported firearms, even those classified as curios and relics. Photo: Peter G. Kokalis**

already done most of the leg work. The bills had been drafted and their routes through the House and Senate committees had been charted. All that remained for Clinton was to establish the timing, measure electorate tolerance levels and malleability of House and Senate members in light of job-creating, vote-buying and pork-projects. The least obvious part of Clinton's anti-gun strategy was to make the best use of federal departments, law enforcement agencies and bureaucratic infrastructure to quietly regulate and bully firearms businesses, and administratively prevent

as many firearms as possible from entering the country.

On 1 October, a front-page story in *The Washington Times* sent the White House and Crime Bill co-author, Rep. Charles E. Schumer into a panic. The story said that the anti-gun Clinton White House was considering a policy that would allow the Russians to sell semiautomatic weapons in the United States. In return for access to the American gun market they would decline a \$1 billion opportunity to sell everything from MiGs to nuclear submarines to Iran.

Schumer, an anti-gun congressman usually sympathetic to Russian desires, protested in public that the White House was intending to "reward" the Russians by "allowing them to sell weapons to our kids." Official spokesmen at the White House and elsewhere allowed that there had been talk about it, but they quickly denied that the deal was being seriously considered. When the press corps impudently asked how it would explain the irony of the most anti-gun president in history considering a move to allow the import of wholesale lots of weapons he had battled to prohibit in legislation, Dee Dee Myers replied, "in our trade laws there is room for the import of weapons."

Unless she was being extremely cute with wise-ass reporters, Myers had unwittingly fingered the major initiative of Clinton's covert plan to disarm America. Suddenly import license applications from former Soviet Union countries were frozen. As many as 700,000 SKS semiautomatic rifles and Makarov pistols were blocked administratively. The importing companies as well as the Russian government were told simply that the current U.S. policy on firearms imports was under review.

By using America's trade laws and bureaucratic techniques to confuse those laws, Clinton had earlier been able to block millions of dollars of firearms from being imported into the United States from China in May of 1994. It had been easy. The President said, "do it," and suddenly the burden of proving that the government was in violation of the law fell on the businesses affected. The Chinese did not complain, they were given 10 days prior notice — a luxury Clinton denied American firearms importers.

The administration did not stand

still. In a series of what senior federal law enforcement officials described as "monologues," White House whiz-kid George Stephanopoulos told the director of the Bureau of Alcohol, Tobacco and Firearms (BATF) to do whatever was necessary to block firearms coming into the United States. The press secretary-turned-policy-expert said that the White House had not been satisfied with the Treasury Department's progress. Subsequently, nearly all import license applications involving firearms classified as curios and relics, often of special interest to collectors, were frozen.

### Who Needs Congress

Almost everything firearms-related, paid for or not, that had been purchased for import into the United States was essentially embargoed. License applications that passed through the State Department for goods from proscribed countries were held up under the direction of the Clinton administration. Nothing was coming out of China. Unless an application was for a half-dozen shotguns or bolt-action sporting weapons, licenses for curios and relics were suddenly and mysteriously misplaced by the BATF. More than \$200 million worth of firearms import license applications were simply suspended in the various paper flows of the Treasury Department bureaucracies. The White House had cleverly banned importing firearms from these countries, while masking this gun control measure as a foreign policy decision.

Firearms importers soon raised hell about the bureautic red tape suddenly blocking access to their stock in trade. When they hired lawyers, lobbyists and began writing letters to their senators, the White House decided to be a bit more quiet. Principal importers met and organized to address the de facto import ban and formed the FireArms Importers Roundtable (FAIR) trade group. An early success was realized when an amendment was attached to an appropriations bill providing relief to importers who lost goods en route from China when the president's embargo was enacted.

FAIR organized a meeting with the BATF to determine the intent of import licensing application delays. BATF spokesmen at the meeting expressed surprise and confirmed that

although the Bureau was reviewing the curio and relics regulations, no decision had been made or implemented. FAIR raised the possibility that the BATF was holding these applications until such a decision had been made. The Bureau representative was emphatic that no instructions had been issued to block large-quantity permit applications. Yet they admitted that one importer had been informed that a high percentage of their pending applications had been lost and will have to be resubmitted, another percentage had been sent to the State Department for review, and even others were being reviewed by the chief counsel of the Technical Branch though they were simple, straightforward applications.

After further negotiations between FAIR and the BATF and crucial assistance from key congressmen, licenses were issued for importing curios and relics from non-proscribed countries. However, the import ban on China and the de facto embargo from former Soviet Union countries remains in effect.

A senior federal law enforcement official said that an embargo of firearms imports into the United States from China combined with the frozen import license applications was absolutely unprecedented. He noted that never before had any White House ever implemented such a sweeping prohibition without consulting Congress or using so much as an official order. It had all been implemented based on the fear that if the federal agents involved refused to go along with this under-the-table policy, it would mean their jobs. He admitted, "No one here likes the idea, but if somebody tells me that Hillary wants gun imports blocked, I'm going along because I've got a mortgage and two kids in college."

Legislative intent is nullified when, by design, administrative procedures are used to destroy the democratic process. It has been noted that the lowest bureaucrat has more power over an individual's life than the most nefarious dictator. When the two team together to bypass constitutional safeguards they create just the condition our Founding Fathers envisioned when they included the Second Amendment in the Constitution. Perhaps this helps explain the president's anti-gun zeal. ✕

# GEAR ON GEAR ON GEAR ON GEAR ON GEAR

by Galen Geer

**This review** of what's new and good began last issue, and continues with more good-gear items that received hands-on tests and high marks from the *SOF* staff on safari in Africa and on hunts in Florida and Colorado.



## SIGHT MASTER

Having progressed through a number of variations, the Sight Master has evolved into my choice for a hunting-bow sight because it eliminates the need to bracket my sighting — or to try to remember which pin is for what range.

The Sight Master is made from aircraft aluminum and has one-touch adjustment, so the cross-hair sight can be set at the correct range while the bow is held in shooting position. *SOF's* publisher and editor, Robert K. Brown, had a Sight Master installed on his bow for hunting in Africa last year, as did I. They work. For more information contact Sight Master, Dept. SOF, 1093 Highway 12 East, Townsend, MT 59644; phone: 406-266-5516.



## EUREKA!

All tents wear out and have to be replaced, including the tents used for more than 10 years at the annual *SOF* hunting camp.

We turned to Eureka Tents for our replacements and after examining their various styles we settled on two types, both two-room models that would give our hunters more privacy and space: Eureka's Long Lake and Northwoods Lodge tents.

The Long Lake tents are 13' 8" by 8' 11" with a large door awning. The walls are 1.9-ounce taffeta nylon, the floor is 4-ounce Oxford nylon and it has a poly/cotton roof. The tent frame is aluminum and the bug netting is nylon.

The Northwoods Lodge has a front

awning of 12' by 7' with a floor 16' by 9' 6" and a center height of 7' 7". The walls are made from Eureka's StormShield cloth, the roof is 1.9-ounce permeable polyester and the floor is a heavy-duty 4-ounce Oxford nylon. The tent frame is shock-corded aluminum tubing and the netting is all polyester.

After 10 years of hunting from dark, smelly, canvas tents, the Eureka's made for a whole new hunting camp last year. For more information, contact Johnson Camping Inc., Dept. SOF, 625 Conklin Road, Box 966, Binghamton, NY 13902; phone: 607-779-2200.



## ACTION EAR

Loaded with useful features, the Action Ear Sport is the culmination of more than 12 years of technological development by Silver Creek Industries.

It has a dual-headband system using a collar-level tension band and an over-the-head Velcro strap, which provides a comfortable and secure fit. The ear cushions use a unique behind-the-ear raised section and a pillow-like air-and-foam construction that gives an outstanding sound seal without squeezing your head.

I tested the Action Ear Sport in Florida on a wild hog hunt, and its two amplifying settings, stereo sound amplification and individual volume controls to adjust for hearing differences in each ear proved exceptional.

Silver Creek definitely has a winner with the Action Ear. For more information, contact Silver Creek Industries, Dept. SOF, Box 1988, Manitowoc, WI 54221-1988; phone: 800-533-3277; fax: 414-684-6267.

## CAMELBAK HYDRATION SYSTEM

The Camelbak is a unique, hands-free water carrying system for personal use in the outdoors.



The Camelbak system is silent, soft-sided, fully insulated, and uses a patented bite-actuated silicone valve to dispense water.

This ultra-lightweight system has twice the capacity of standard canteens. It can be worn as a small backpack or mounted to flotation vests, backpacks, tactical vests and so on — a true hydration system and not just another canteen.

For more information, contact Camelbak, Dept. SOF, P.O. Box 1029, Weatherford, TX 76086; phone: 817-594-1000; fax: 817-594-1030.

### EMERGENCY FOOD AND WATER

Survival depends on food and water, whether adrift at sea, lost in the bush or enduring the aftermath of a natural disaster. A new ration and drinking water packet from Viking Life Saving Equipment provides high quality emergency nutrition for such situations.

The emergency food bar ration provides 2,500 calories with 11 essential vitamins. The 500-gram (1 pound, 2 ounce) ration consists of nine two-tablet food bars, allowing food to be carefully portioned.

The ingredients are primarily baked wheat and vegetable protein, and are acceptable to all cultures and religions. The protective packaging used to seal the ration is a vacuum-



packed trilaminate foil, which is then packed in a cardboard box. The food bars have a guaranteed shelf-life of five years.

Seven Oceans emergency food bars and drinking water are distributed by Viking Life Saving Equipment, Dept. SOF, 1625 N. Miami Ave., Miami, FL 33136; phone: 305-358-7446; fax: 305-374-1535.



### ECONOMICAL CHRONOGRAPHS

Two good, new picks for reloaders and anyone else who wants to know the speed at which bullets travel are the Hornady Chronomax and the Competition Electronics ProChrono chronographs.

The Chronomax is designed for easy use by utilizing a separate pocket-sized command box with an easy-to-read liquid crystal display that reads *fire* and a string of up to five shots. It has buttons for *on/off* and *reset*. The skyscreens are connected to the command box by a single cable and are spaced three feet apart on a rigid mounting assembly bracket for greater accuracy. This screen bracket rests on built-in legs that store inside the mounting assembly when not in use.

The ProChrono is a one-piece unit that sets up on a camera tripod. After setting up the screen, the unit is switched on and you are ready to chronograph your ammo.

If you want to add the extras, you can buy an indoor lighting setup for use on indoor ranges, a remote control for displaying the results without walking back and forth, and even an infrared thermal printer.

For information on the Hornady chronograph, contact Hornady, Dept. SOF, Box 1848, Grand Island, NE 68802; phone: 308-382-1390.

For information on the ProChrono, contact Competition Electronics Inc., Dept. SOF, 3469 Precision Drive, Rockford, IL 61109; phone: 815-874-8001; fax: 815-874-8181.



### BROWNING'S AFTERBURNER

Browning's line of industrial-quality Ballistic lights are internationally approved and have undergone government tests from Europe to New Zealand.

This year Browning introduced the Afterburner Ballistic Lite, which provides two dependable light systems in one by having two 60,000 candle-power alternate filaments in its xenon bulb.

Pulling the switch to the right activates one filament and to the left activates the other. Each filament is powered by its own independent wiring and four D-cell batteries.

Should the batteries or filament fail in one circuit, you simply pull the switch the opposite direction for a new filament and a fresh set of batteries.

For more information, contact Browning, Dept. SOF, One Browning Place, Morgan, UT 84050-9326; phone: 801-876-2711; fax: 801-876-3331.

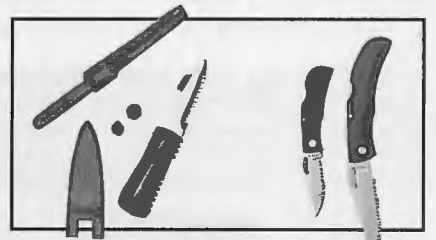

### GERBER'S E-Z-OUT AND RIVER SHORTY

Two patented features make the E-Z-Out knives from Gerber Legendary Blades easy to open and to carry. First, these handy folders have a thumb cutout in the blade, allowing it to be opened with one (cold, wet) hand. Second, the E-Z-Out has a built-in clip to eliminate groping in a

*Continued on page 60*



# Black Bullets for Black OPS

## Russia's Secret Ammo Revealed

by **SOF Staff**

Although much has been published regarding new small arms developments in Russia, scant note has been taken of the ammunition for these innovative small arms, even though the Russians designed them as complete systems, integrating ammunition and firearm. They have recently introduced several new rounds to improve performance in existing weapons, many touted as having enhanced penetration capability.

One such improved round is the SP-4, successor to the SP-3, a 7.62x62.8mm captive-piston, sound-suppressed cartridge used in the MSP two-barrelled "assassination pistol." (SOF was the first to expose this round: see "Mystery Bullet," May '90 and "Combloc Connection," July '90.) The SP-3 cartridge functions in such a way to make it next to impossible to design a semiautomatic or automatic weapon for it, because when this cartridge is fired, the internal piston that propels the bullet protrudes from the case mouth for over half its length. The same is true for the older 7.62x35mm silent cartridge.

This protruding piston problem was solved with the SP-4 7.62x42mm,



which retains the propelling piston completely inside the cartridge. This improvement also allows the cartridge to be used in compact, self-loading firearms, such as the PSS "Vul" silent pistol.

The ancestor of both the SP-3 and SP-4 cartridges was probably the 7.62x35mm suppressed cartridge, of which little is known. The weapon firing this cartridge has never been publicly shown, but the fact that two cartridges are held in a clip implies that it is used in a two-barreled firearm similar to the MSP. It is possible that performance of the 7.62x35mm round was inadequate, thus leading to the design of the larger SP-3 7.62x62.8mm suppressed cartridge.

Moreover, the 7.62x35mm case wall appears to be no thicker than standard, which could have been problematic due to the necessity of retaining the high-pressure gases inside the fired cartridge case. For differing reasons, both the 7.62x35mm and 7.62x62.8mm cartridges appear equally complex to manufacture. What is significant is that both fire a 122-grain steel-cored bullet virtually identical to that of any 7.62x39mm weapon. This is highly desirable in a clandestine firearm, serving to confuse authorities attempting to iden-



Russians are now regulars at international arms expos. This display, one of many at this large booth, touts the capabilities of their new 5.45mm ammo — secret stuff when SOF glommed some in the early 1980s.



etration (three 25mm pine boards, versus four for the 9x18mm) is the blunt bullet.

### Russian Whisper

Another new cartridge designed for suppressed weapons and compact submachine guns is the Russian 9x39mm cartridge, available in standard and high-penetration configurations for use in two new suppressed rifles and one submachine gun. The standard round is designated the SP-6, the high-penetration cartridge the SP-5. Both are subsonic, firing a relatively heavy 250-grain bullet at 950 fps.

The concept behind this and the latest subsonic 7.62x39mm round discussed below is similar to that employed by SSK Industries in the United States in their "Whisper" ammunition — a relatively heavy subsonic bullet to avoid the "crack" of high-velocity ammunition, while maintaining adequate terminal effects via bullet mass. In conventional ammunition, the two basic methods to increase the terminal effects of a projectile are to increase its velocity or increase its mass (this is admittedly a simplistic explanation of a very complex subject). With silenced weapons, however, any velocity higher than approximately 1,100 feet per second (fps) causes a supersonic "crack."

The "whisper" concept also reduces muzzle blast, making such cartridges ideal for use in short-barreled submachine guns, while giving the weapon much better ballistic performance than with pistol cartridges. The only similar Western weapons are submachine guns chambered for 5.56x45mm NATO, but these all fire their bullets at supersonic velocities, which is necessary to achieve any degree of terminal effect with light 5.56mm bullets. The SP-5 high-penetration round appears to have a hardened steel or tungsten penetrator tip similar to ammunition for the P-9 "Gurza" 9x26mm.

### More New Silent Ammo

According to Russian press reports, the SP-5 is intended primarily for use as an anti-materiel round in the VSS "Vintorez" silent sniper rifle, while the SP-6 is mainly for use in the "Val" silent assault rifle and the A-91 submachine gun. The Russians claim the SP-5 round will penetrate a 2mm

tify an assassin's gun. It would not be surprising to find that rifling in the MSP, and whatever weapon fires the 7.62x35mm round, is very similar to a standard AK.

The SP-3 cartridge, used in the MSP assassination pistol, is an improvement on the 7.62x35mm, probably specifically designed as an integral component of the MSP weapons system. The SP-3 casing is lacquered steel with much thicker case walls than standard — indicating the earlier 7.62x35mm round did have case rupture problems.

A comparison of all three suppressed cartridges shows the first, 7.62x35mm, has case walls virtually identical to a standard cartridge. The 7.62x62.8mm SP-3 has extremely thick case walls and a threaded case head incorporating an integral firing pin and internal primer completely sealing the cartridge head. The most recent SP-4 7.62x42mm cartridge is an "in between" design with more conventional case head and primer, and a case thickness that falls between the earlier cartridges.

The PSS pistol/SP-4 cartridge system is an innovative, sophisticated combination allowing use of a suppressed cartridge in a semiautomatic pistol. The SP-4 bullet is a new de-

**Previously disinclined to disclose or provide to client states their latest weapons or technology, new ordnance from former Soviet Union remained largely a mystery. In the early 1980s on a trip to Afghanistan, SOF Editor/Publisher Robert K. Brown was one of the first Westerners to test fire the new AK-74 rifle. Brown subsequently "liberated" and "exported" 5,000 rounds of the new 5.54x39 ammo on behalf of U.S. intelligence. Now, Russians gladly sell latest developments to all comers. Photo: SOF file**

sign, comprising a low alloy steel cylinder, splined at one end with a copper driving band swaged onto it. There is a recess at the rear of the bullet mating to a tit on the top of the drive piston. This centers the bullet in the cartridge casing and helps stabilize it as the piston pushes it out to engage the rifling.

Russians claim the SP-4 approaches the 9x18mm Makarov in power, which would place it in the 9x17mm (.380 ACP) class. The 9x18mm Makarov cartridge develops 237 foot-pounds muzzle energy in its standard military load, while the 9x17mm generates approximately 200 foot-pounds — both significantly less than standard NATO 9x19mm rounds generating 465 foot-pounds. Articles in the Russian press, however, say the reason for the SP-4's poor pen-

steel plate at 500 meters and a 6mm "high-density" steel plate at 100 meters, while retaining sufficient energy for disabling targets behind the steel plates. Although these claims are unproven, they do not appear exaggerated and are in keeping with test results of similar cartridges developed here.

The 9x26mm cartridge for the P-9 "Gurza" (Viper) pistol is yet another new Russian design, apparently at the high end of the pistol ammunition performance spectrum. Russian articles and advertising brochures state that a bullet fired from the Gurza will penetrate a protective vest consisting of two 1.2mm titanium plates and 30 layers of Kevlar at a range of 70 meters. If accurate, this represents a very high level of performance. With a muzzle velocity of 1,378 fps, the 9x26mm round is in the .357 Magnum class. Russian press articles state the 9x26mm round was specifically designed as a high-penetration cartridge to defeat body armor.

It appears that the designers have achieved their goal, as this cartridge not only has a high velocity, but fires a bullet that appears to incorporate a steel or tungsten penetrator. As with any cartridge design, there are usually tradeoffs to achieve high levels of performance in one specific area. In this case, it is possible that penetration is achieved at the expense of terminal effects on soft tissue.

Another type of specialized ammunition recently introduced

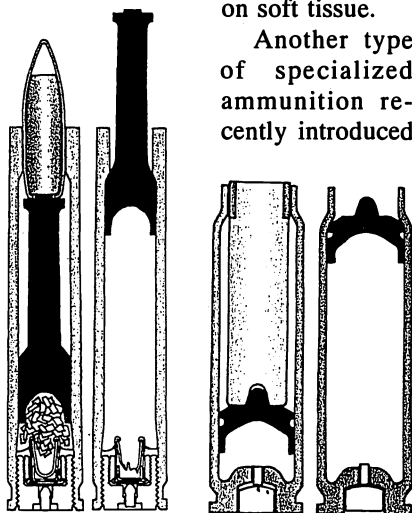

The SP-3 7.62x62.8mm suppressed cartridge, left, had a design that precluded its use in automatic mechanisms. SP-4 9x42mm suppressed cartridge, right, will function in fairly conventional pistol and automatic weapon actions. These secret, silent rounds were first disclosed by SOF four years ago.

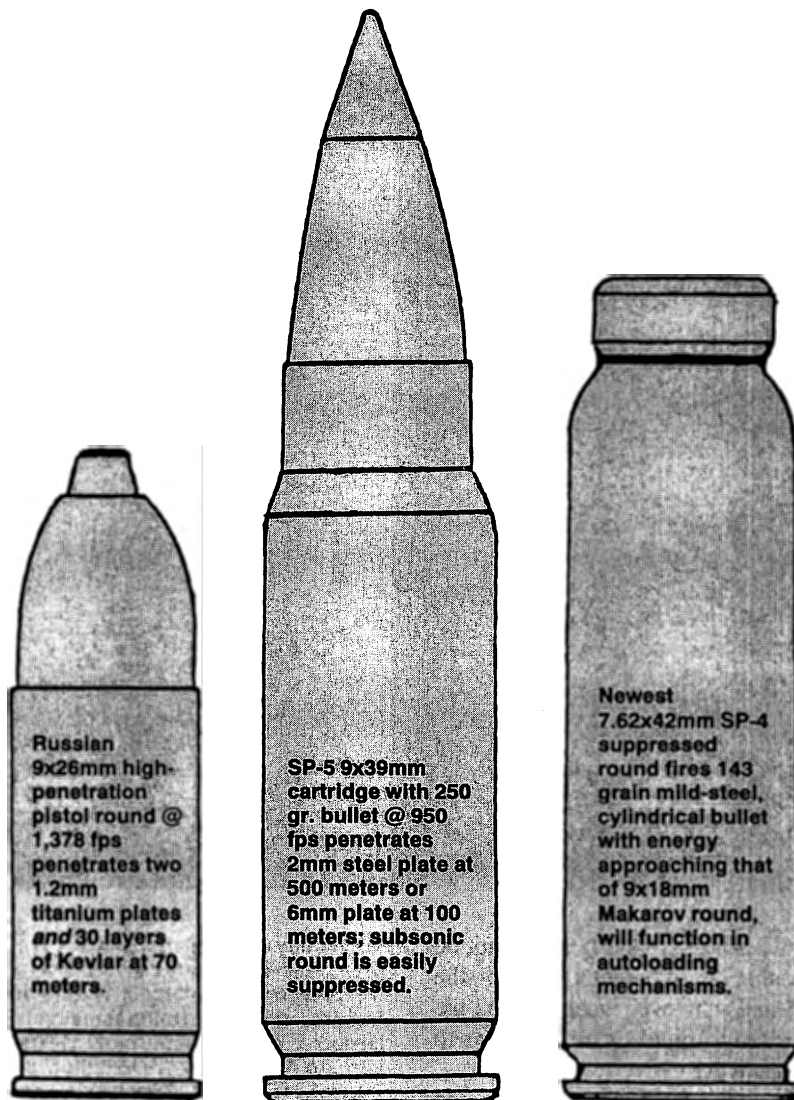

Russian 9x26mm high-penetration pistol round @ 1,378 fps penetrates two 1.2mm titanium plates and 30 layers of Kevlar at 70 meters.

SP-5 9x39mm cartridge with 250 gr. bullet @ 950 fps penetrates 2mm steel plate at 500 meters or 6mm plate at 100 meters; subsonic round is easily suppressed.

Newest 7.62x42mm SP-4 suppressed round fires 143 grain mild-steel, cylindrical bullet with energy approaching that of 9x18mm Makarov round, will function in autoloading mechanisms.

by the Russians is for their underwater pistol and assault rifle. The pistol ammunition is 4.5mm, while the underwater assault rifle is 5.66mm. Both cartridges fire bullets that are in reality darts or "long rod penetrators." The reason for darts has to do with peculiarities of optimizing ballistics of a bullet fired in a liquid medium. The Heckler and Koch P-11 underwater pistol also fires dart-shaped projectiles.

The stated effective ranges in the open air of both the underwater assault rifle and the pistol is substantially less than conventional weapons, due to heavy weight of the "dart" relative to the propellant. The final analysis is that this ammunition is optimized for special purpose weapons and has little utility for use by personnel other than divers.

The Russians have not ignored specialized ammunition for older weapons; they are now offering improved performance ammunition for virtually every small arm and in every modern

caliber they ever manufactured. The new 7N10 high-penetration 5.45x39mm cartridge is intended to defeat protective vests at 200 meters and replaces the much tamer 7N6. The bullet from the 7N10 round is claimed to penetrate a 10mm thick mild steel plate at 300 meters.

The original 7N6 round was constructed with a hollow space in the tip. When the 7N6 bullet strikes its target, a lead and steel core moves forward to fill the hollow space in the bullet's tip. This unbalances the bullet forcing it to "tumble" in soft tissue, compounding the wound effects. Testing in the United States and elsewhere has shown that the 7N6 bullet will rotate 180 degrees on its long axis and turn base forward in ballistic gelatin virtually 100% of the time. As it turns, the bullet veers approximately 90 degrees from its original path. The Russians claim that the new 7N10 round is 1.84 times more effective than cartridges with conventional bullets.

Russian literature does not state just what the 7N10 bullet is more effective than. It should be noted that the muzzle velocities of the 7N6 and 7N10 bullets are identical, while the latter cartridge fires a heavier bullet. The internal design of this new bullet is not known, nor can it be determined whether or not the new round will have the same anti-personnel effectiveness as the 7N6, but the external appearance of the two cartridges is identical. Whether the 7N10 depends solely on the additional bullet mass or altered internal design for its increased lethality is unknown, but the Russians claim it will penetrate a 12mm steel plate at 100 meters, while the 7N6 is only marginally effective at that range, leading to the conclusion that the new round has an improved penetrator.

### New Rounds For Old Rifles

The venerable 7.62x39mm cartridge has not been overlooked and is also being manufactured in specialized variations. The Russians recently announced a subsonic 7.62x39mm round, designated 57-N-231U. The theory behind this round is similar to that discussed above with respect to the new 9x39mm subsonic cartridges — increased bullet weight to offset the loss of velocity required to obtain the desired noise level reduction.

While the standard 7.62x39mm cartridge fires a 122-grain bullet at 2,346 fps, the new subsonic round has a 193-grain bullet that leaves the muzzle at 968-1,017 fps. The advertising of this subsonic round for silent firing implies there is probably a suppressed or special operations weapon in 7.62x39mm caliber either in R&D or in *Spetsnaz* inventory. This would be in keeping with the two suppressed weapons in 9x39mm shown at international arms shows recently.

The 7.62x54mmR (7.62x53mm) cartridge has been in Russian military service for more than a hundred years, with no sign of retirement, still

used both in medium machine guns and the SVD Dragunov sniper rifle. As with other standard Russian cartridges, there is now a high-penetration round in 7.62x54mmR caliber, the 7N13. The Russians have also introduced a special sniper cartridge, the 7N14, presumably for use in the SVD Dragunov. The Russians view snipers somewhat differently than the West and the design of the SVD reflects this. The SVD does not possess the accuracy associated with Western sniper weapons and the new round may be an effort to improve the SVD in this respect.

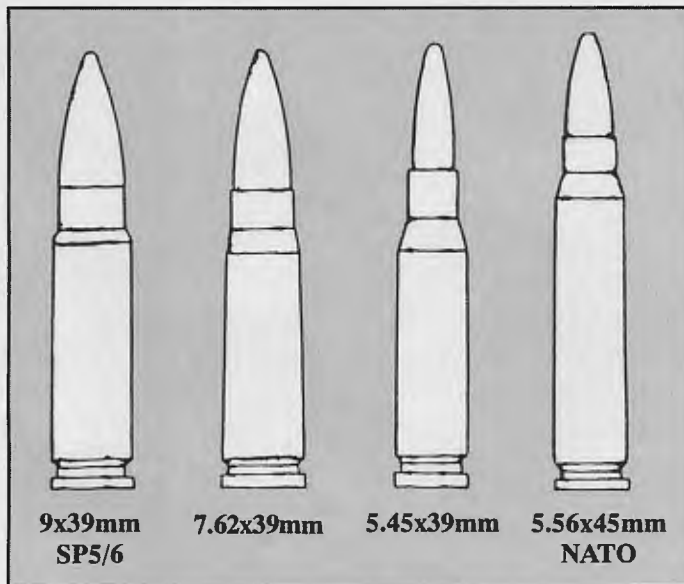

The 7N14 round is thus probably manufactured with greater precision than regular production 7.62x54mmR ball ammunition and can therefore be expected to enhance the accuracy of the SVD. Russian data indicate the round is not designed as a high-penetration cartridge, as its terminal ballistics are below those of the 7N13 round, despite its heavier bullet. Differences between the 7N14 and standard ball ammunition include a 151-grain bullet instead of the standard 145-grain projectile and a brass, rather than lacquered steel cartridge case. The muzzle velocity of 2,723 fps for both rounds when fired from the SVD is identical. The penetration capability of the 7N14 is substantially below that of the steel-cored 7N13, however, indicating that the 7N14 probably fires a lead-cored bullet.

Another development is being newly released, although it dates back to former Soviet involvement in Af-

ghanistan: duplex (two projectiles in one cartridge case) loads for the 12.7x108mm HMG round, a concept identical to the U.S. duplex rounds in 7.61x51mm of the late 1950s. The Russian rounds, however, differ in that the two projectiles are essentially the same size, and the round is also offered in a tracer variant.

Finally, a new 9x18mm pistol round, designated the 57-N-181M, has been developed for the Makarov pistol and new 9x18mm submachine guns, which according to the Russians has "great stopping effect." The bullet design is similar to that of other new Russian high-penetration rounds in that it employs a bimetallic bullet jacket with a steel penetrator sheathed in lead. The bullet for this new pistol round weighs 86 grains, somewhat lighter than the bullet of the standard 91 grains 57-N-181S cartridge.

### Power To The Pipsqueak

The muzzle velocity of the 57-N-181M is 1,345 fps, more than 300 fps faster than the 57-N-181S' 1,033 fps. This increased velocity coupled with the steel penetrator gives the 57-N-181M a 90% probability of penetrating a 4mm steel plate at 20 meters, beyond the usual range of combat pistol engagements. Muzzle energy of the new 9x18mm round is 345 foot-pounds, a dramatic improvement over the original 9x18mm's 216 foot-pounds. The improved 9x18mm cartridge is squarely in the 9mm Parabellum range of 341 foot-pounds.

Given the examples discussed above, it can safely be stated that the Russians have shown remarkable innovation in small arms ammunition design, not only for the numerous new firearms they have introduced over the past several years, but also by applying novel ammunition design practices for application in older small arms, as well.

*For a review of leading-edge Russian weapons that utilize the exotic ammunition covered here, see "Russia's Secret Weapons," SOF, July '94. ✕*

# YSTERGARDE



Iron Guard conducts live-fire drills. AWB asserts that although their emblem resembles a swastika, it is a pious grouping of sevens, representing God's supremacy over the 666 of the Antichrist.

## Inside South Africa's Right-Wing Special Forces

by **Anthony C. LoBaido**  
Photos courtesy author

**As I took my place** between a pair of marksman's targets, two former South African Defense Force (SADF) commandos, veiled behind masks, locked and loaded. Quite purposefully and without the slightest trace of emotion, they took aim and emptied their 9mm Z88s into bull's-eyes on either side of my head. The dust settled, my heart resumed beating and my initiation of trust into the shadowy *Ystergarde* was complete: I was allowed access to the Afrikaner resistance movement's (AWB) ultra-right-wing secret society.

I then witnessed a gun-to-the-head vow taken by all new *Ystergarde* (Iron Guard) recruits following their initiation ceremony. After building a stone altar to the Lord, each new Iron Guard member, with a loaded gun pointed to his head by a superior, proclaims a vow of loyalty.

Throughout the rest of the day, *Ystergarde* soldiers doggedly engaged in special forces training that included tactical scenarios, CQB, demolitions and bush warfare. For hours they labored under tutelage of professional mercenaries from Israel, Ireland, Holland and even a former British SAS officer. I participated in maneuvers with these dedicated soldiers, carried a sniper weapons-system and engaged in live-fire hostage-taking scenarios. This group lacked nothing in terms of equipment, training and motivation. Everyone carried a sidearm, and their arsenal included large numbers of R4 assault rifles, grenade launchers and combloc RPGs.

In 1991 the *Ystergarde* clearly ranked as the African

the ANC ... land which our forefathers paid for in blood. It's well known that the Afrikaners helped Israel to develop her nuclear arsenal. Can there be anything more anti-Nazi than standing by Israel with fierce loyalty?"

"All of Pretoria's friends have betrayed her," added Franz Pretorius, a hulking former SADF assassin who claimed to have carried out missions in Angola, Afghanistan and the West Bank. His voice was surprisingly soft and well-modulated, not befitting the long scar that ran down the right cheek of his ruddy, tanned face. "Many of

**"If I lead — follow. If I desert — shoot me. If I die — avenge me. So help me God." — Ystergarde Vow**

our people have gone into exile in Toronto, Houston and South America. Our foes are now our masters. They have laid hands on all of South Africa's mineral treasures, for now."

Such lamentations were not uncommon among the AWB members I spoke with. Despite the optimism surrounding the dismantling of apartheid, endemic street crime, rape and bank robbery have terrorized blacks and whites alike. Their frustration was evident when one of the

*Ystergarde* faithful went so far as to inquire if I would be willing to arrange an interview with certain hated parties and bring along a team of *Ystergarde* members posing as "photographers" in order to carry out an assassination.

After numerous meetings with *TerreBlanche* and visits to different levels of the AWB training structure, I was surprised to find the *Ystergarde* to be basically a capricious collection of ardent Christian fundamentalists, Boer patriots and anti-New World Order zealots with little regard for matters concerning race. In fact, to the average member the native Zulu is a blood-brother, an ally against a communist onslaught the likes of which the Boer has not seen since

1838 during the days of the "Great Trek." This collection of doctors, artisans, lawyers, engineers and photographers, was ready to risk all to secure the freedom of self-determination in an Afrikaner homeland — a sequel to the wars of independence their forefathers had fought, and the combat they had endured in Rhodesia, Angola and across southern Africa.

"We have always stood by the Americans and the Brit-



**AWB is remarkably well armed with weapons from the SADF and from many border wars over the years. Some weapons have allegedly come from American Special Forces sympathizers operating in Angola.**

National Congress' (ANC) worst nightmare — a team of ex-specops personnel extraordinarily equipped, ready and willing to do the bidding of the fiery and mercurial AWB leader Eugene *TerreBlanche*. Leon Van der Merwe, commander of the *Ystergarde*, spelled out the philosophy of the AWB and bristled at Nazi comparisons made by the international media. "We're not Nazis. We're Christians defending our land ... from the communist anti-Christ of

ish," Van der Merwe told me. "In both World Wars I and II, in Korea, Afghanistan and even Central America we helped you *Amerikaners*. But the New World Order crowd, led by that traitor George Bush in conjunction with the United Nations, has betrayed the Afrikaner on the altar of global socialism." What Van der Merwe claims is true, even to the point of purchasing some 200,000 pounds of East German weapons on behalf of the South African government and shipping them to Nicaraguan Contra leader Eden Pastora on the Danish freighter *Pia Vesta* back in the days of P.W. Botha.

### Training For The Whole Family

Contrasting the high-level operational skills and fanaticism of the Ystergarde were the low-level weekend camps organized by the AWB for families scattered around South Africa. I was offered the chance to visit such a camp in western Transvaal as a personal guest of AWB *Hoofkommandant* Jappie Oelofsen.



Former SADF special forces and Recce personnel train under the instruction of British SAS officers and mercenaries from Israel, Ireland and Holland.

Oelofsen greeted me with the traditional AWB handshake (grabbing the wrist in lieu of the hand) and led me on a tour of his training camp. The immediate area was bordered by several rows of tents, autos and a parade area where the Orange Free State and Transvaal flags flew high above the compound.

The group of 80 recruits prayed for guidance and launched into practical handgun drills for adults and children alike. The well-disciplined students conducted the exercises with precision and excitement. I was once again surprised to find how disappointingly normal they appeared to be. All claimed a desire to live in peace with the blacks. All wanted to see apartheid come to a swift and just end. And all blamed the terrorist necklacings and ear-cuttings of the ANC for inciting discord. Special venom was reserved for East European Joe Slovo, leader of the South African Communist Party.

The Boers were quick to claim that they were "the most forgiving culture on earth, [having] granted absolution to the Zulu, English and even Jan Smuts." Far from talking like the ordinary beer-guzzling yahoos portrayed in the Western press, these men and women talked articulately about everything: Russian-backed liberation theology, restrictive gun laws, the plight of farm workers and the plague of AIDS

that they believe will one day destroy all of Africa.

"The men, women and children in Kenya, Rhodesia, the Congo and South-West Africa [SWA] all had South Africa to fall back on," Oelofsen sighed. "Where are we supposed to go? Antarctica?"

Oelofsen was also concerned about the AWB image and did his best to explain the fabrication of Nazi and AWB comparisons. The ex-SWA special forces vet agreed that their symbols were similar to the Nazi swastika and probably damaged public perception of the AWB movement and hindered recruitment. But he contended their logo is a pious grouping of three sevens representing God's holy resistance to the 666 of the Antichrist.

An SADF intelligence officer in Pretoria later told me that the SADF had been hunting a wealthy German national living in Swakopmund, Namibia. The German, the SADF learned, had escaped from Nazi Germany with priceless art treasures pillaged during the war. After laundering the fortune in Brazil and Argentina, he had returned to the former German colony of South-West Africa in the mid-1970s and began bankrolling the AWB. This might explain the Germanic operational nature of the AWB leadership as opposed to the common anti-racist, anti-Nazi, pro-Christian rhetoric of the average AWB member. And this may explain how a poor pumpkin farmer like TerreBlanche could afford to finance a BMW and the AWB.

### The Third Boer War

The current status of the AWB and the Iron Guard is tenuous at best. Though the ANC has agreed to negotiate "in principle" on the idea of a Boer homeland, it appears unlikely that TerreBlanche will secure his dream of a sovereign territory consisting of the Orange Free State, western Transvaal and northern Natal.

A large portion of the Iron Guard's elite troops were arrested as suspects in the Jan Smuts Airport bombing spree during last April's election. Many others are rumored to be in hiding in the hills near Barberton, where SADF intelligence sources claim the Boers have hidden gigantic weapons caches. However, droves of Ystergarde and SADF special forces gear is being auctioned off by major international military dealers in Johannesburg, possibly indicating that the Iron Guard has abandoned its huge training camps and gone to ground.

TerreBlanche is far from willing to admit defeat. He told me, "Somewhere along the line the Afrikaner lost Jesus Christ as our true shepherd. The Third Boer War will be our way back to Him. I hate to say this, but the idea of ... different races and cultures and nations living in peace together is a fantasy. Just examine the current situation in the former Soviet Union, or Bosnia, Ireland or even Los Angeles."

His view is seconded by Peter Hammond, an elite SADF special forces and Angolan War veteran who heads an evangelist program in southern Africa: "There are only two types of people in South Africa. Those who believe there is no problem and those who believe there is no hope.

"Marxist dictators like Castro, and terrorists like Yasir Arafat, along with Big Sister Hillary Clinton were toasting the communist takeover of South Africa at last year's inauguration. It was a great victory for terrorism, propaganda,

sanctions, subversion and fraud," Hammond lamented.

"The American public is so caught up with their daily bread and circuses that we don't realize the full implica-

fighting for white supremacy but for freedom from the horrors of a totalitarian one-world government. Traitors like F. W. De Klerk and Pik Botha will be hunted down in Switzerland and necklaced in the ANC tradition."

Ever defiant, TerreBlanche continues to boast of ultimate victory: "The Boer aren't the weak, obese, pathetic idolaters that the Americans have become. Christians have always had to fight for their freedom in the tradition of the World War II resistance movements all over Europe. Even now Christians are winning in the Sudan, Angola and Mozambique. And don't forget, we have many friends in both Europe and the U.S.

"We are experts in guerrilla fighting. The British came here a century ago claiming they would mop us up in what Lord Kitchner called the 'Tea Time War.' But his empire wound

up spilling more blood in South Africa than in all other English campaigns conducted in the 19th century combined." For now, however, TerreBlanche and the Ystergarde remnant can only continue to close ranks with the Zulu and prepare for their day of rebellion, be it real or imagined.

*Anthony C. LoBaido was the first journalist to penetrate the AWB. His articles have appeared in the Johannesburg Sunday Star and he has recently completed a novel entitled The Third Boer War, being marketed by Canadian Literary Associates in Edmonton, Alberta. ✂*



**With Mandela unable to control the former ANC gangs, only the worst fool walks the streets unarmed and unprepared — adding to the popularity of AWB family training camps.**

tions of a communist South Africa," said Louis Tambs, a former U.S. ambassador. "What happens if someone like Zhirinovsky comes to power in Russia? He will be able to implement the Brezhnev doctrine of controlling the strategic mineral treasure chest of southern Africa and then set his sights on the oil in the Middle East. If something happens along the Suez Canal, Western control of the Cape of Good Hope is going to be vital to America's national security."

Hammond, however, sees a silver lining in the fact that on 31 March 1994, the SADF refused to invade KwaZulu and carry the Zulu leadership away as ANC prisoners. "We in the SADF were never defeated on the battlefield," he said during a recent tour of the United States. "We were betrayed. Now we see the riches of our land handed over to foreign squatters and revolutionary parasites. But the communists are anti-God, anti-freedom and anti-family, and they are already sowing the seeds of their own destruction. One day we'll see a truly free, democratically elected constitutional, non-racial republic in South Africa with a prosperous free-market economy to boot."

### Scum Of The Earth

While the remnants of the AWB still organize to battle the "one settler, one bullet" rhetoric of the Pan African Congress, they are unnerved by the fact that the United States is presently constructing airbases in neighboring Botswana, ostensibly to assist a future invasion of U.N. peacekeepers to put down a Boer-Zulu rebellion, according to Hammond.

"Let them come," says one former Ystergarde member, now residing in relative safety in Windhoek, Namibia. "The U.N. troops are always comprised of the scum of their respective national outfits. Natal is an awful place — cold, hills and dense cover. The socialists of the New World Order will be disemboweled by the Zulus, who love their monarchical heritage. The Afrikaners won't be



**AWB weekend camps provide training for rank and file members. Average Boer views the Zulu as an ally in battling a communist ANC invasion.**



# Heckler & Koch

## Can Ultra-Secret H&K 50 Stifle the Steyr?

by Nick Steadman

Heckler & Koch's newest 5.56x45mm weapon system, the HK50, is conspicuous by the amount of secrecy surrounding it. Little has been written about this rifle, H&K won't talk about it and photos and specs of it are kept close-hold. Most of this secrecy is due to its competing with the Steyr AUG in a race to replace the G3 rifle and UZI sub-machine gun for the *Bundeswehr's* component of the European rapid re-

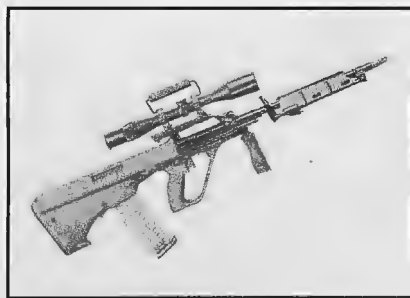

Steyr already has an HBAR variant of the AUG with a 42-round magazine, longer barrel and bipod. There appears to be little difference between H&K's rifle and LMG other than magazine capacity. Photo: courtesy Steyr-Mannlicher

action force.

Students of Bundeswehr small arms strategy are allowed a wry grin as they'll remember that when NATO agreed on the 5.56x45mm SS109 cartridge as an alliance standard, Germany declined to sign, saying that

5.56x45mm offered no significant advance on 7.62x51mm NATO. Of course, that was when German forces still expected to receive the caseless 4.73x33mm G11 rifle. But when East Germany joined the fold and the full cost of reunification was computed, many military programs were put on ice: The G11 was one.

Germany has decided to live with the 7.62x51mm G3 for the foreseeable future, but the prospect of some units having to work with other European armies armed with 5.56x45mm weapons has compelled the government to seek a limited buy in the smaller caliber. The German army designations for these rifles are G36 and MG36. The final requirement, drawn up in May 1994, is for 33,500 G36 rifles and 2,100 MG36 light machine guns (LMG). Steyr and H&K are the only contenders.

Interestingly, the original request was for an "off the shelf" system, a criterion only Steyr could meet. This wording was changed in order not to rule out the HK50, still a developmental design.

Most readers know the 5.56x45mm AUG family well enough by now. It has the advantage of a long track record and the basic rifle can be quickly reconfigured as a light support weapon by fitting a longer, heavier barrel and a bipod. Special

Due to a virtual news and photo blackout by Heckler & Koch, no information has been made available of the HK50. This photocopy from H&K's internal literature is as close as the outside world has come to seeing the HK50.

42-round magazines are optional.

But what is the HK50? Immediately after Royal Ordnance acquired H&K in March 1991, the two com-

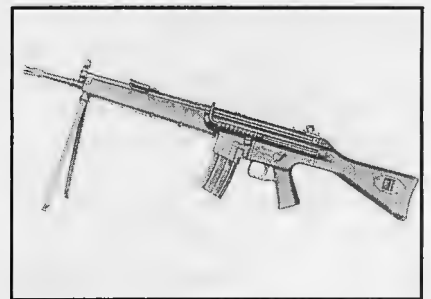

Why didn't H&K's G41 survive? A NATO compatible version of the HK33 utilizing standard M16 magazines, it would have easily filled Bundeswehr's current requirements. Photo: courtesy H&K

panies planned to jointly produce a new, budget-priced 5.56x45mm system as a "love child" of the new relationship. This is what we now know as the HK50. For reasons known only to itself, H&K is maintaining a total blackout on HK50 news and photos, but some basic facts are already avail-

# 's Mystery Rifle

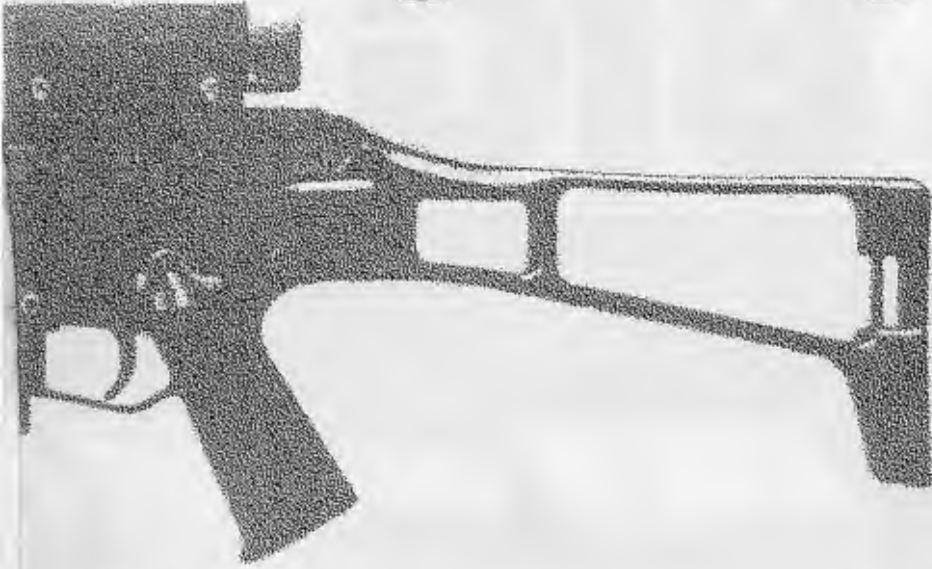

able in open source documents such as the Bundeswehr journal *Soldat und Technik*. And we have at least inspected the carrying handle!

It is uncertain whether H&K already had a design drawn up before the company was bought out, though that is very likely, but it is known the U.K./German production plan, scheduled for 1992, never happened. And after another year's silence, the first news emerged of the Bundeswehr 5.56x45mm requirement.

The HK50 is a radical departure, since (in the interests of simplicity



Although difficult to pinpoint which other 5.56x45mm designs have influenced HK50, there is some external resemblance to the defunct Sterling SAR87 — a family of systems designed for cheap overseas manufacture. Photo: courtesy author

and cost) the H&K roller-locked, delayed-blowback mechanism has been dropped in favor of gas operation. A conventional rotating bolt is used,

with multi-lug locking along M16 lines. Exact details of the HK50's gas system are unknown. However, given the shape of the handguard and Royal Ordnance experience manufacturing the British SA80, it would be logical to surmise that H&K has probably followed the U.K. lead.

Plastics have been used in the construction of the new weapon to an extent not seen before with this manufacturer. The lower receiver and handguard are made from black synthetics. So too are the skeletonized, side-folding buttstock and the 30-round magazine. Aluminum M16 magazines can presumably also be used. De-

spite the fact that the folded buttstock rests against the ejection port, a cut-out prevents any interference with ejection. There is a new case deflector located behind the ejection slot presumably to help left-handers. A Kalashnikov-type magazine release is fitted, plus the usual H&K-style fire selector, offering

semi- or full-auto modes.

A detachable plastic carrying handle shields a top-mounted, reciprocating cocking handle, and also forms the housing for a 3X optical sight. This scope has an AUG-type ring reticle subtending 6 mils, but the sight picture is cluttered by a horizontal level and marks below to indicate holdover at 600-800 meters. Bundeswehr planners are still toying with a close-combat reflex sight to piggyback on the magnifying optics.

Both the rifle and LMG versions of the HK50 have the same folding stock and 18.9-inch barrels and, at 39 inches, are the same overall length. This figure falls to 29.5 inches when the buttstock is folded. Bare weight is also virtually identical at about 7.2 pounds, but the LMG comes with a bipod and is fed from a 100-round drum. With loaded magazine, the LMG weighs in at 12.7 pounds, com-



Steyr's AUG should be a strong contender for the German G36/MG36 requirement though bullpups undoubtedly require more familiarization and training. Photo: courtesy Steyr-Mannlicher

pared to 8.2 pounds for the rifle. Both variants have a 750rpm cyclic rate. Final choice of magazines for the LMG variant is unknown, but we are aware that Beta Co.'s C-Mag has been considered.

Oddly, only the magazine and

*Continued on page 64*

*AMT Designs Definitive Big Bore Backup*

# Little BIG Gun



**Text & Photos  
by Peter G. Kokalis**

**In my loop** everyone packs two pieces, a primary sidearm and a backup. When the user is given the option, there's never been much disagreement about the primary piece. It's almost always one version or another of the .45 ACP M1911-type semiauto pistol. Both the caliber and the single-action, cocked-and-locked method of operation hold the proper, combat-proven credentials for armed professionals.

The problem has always been the backup. By definition, its principal physical characteristic has to be an

abbreviated envelope, as deep concealment is the first prerequisite. It must be small, exceptionally small. In the past that requirement has always resulted in a compromise chambering, ranging from woeful to marginal. The worst possible choice is the pathetic .25 ACP round. It can sometimes kill, but often enough serves only to further enrage your opponent. It's not my choice under any circumstances.

The .22 LR rimfire cartridge is a somewhat better choice. Solids should be selected over hollow points in this caliber, as they will penetrate up to 13.5 inches of soft tissue while expanded hollow points are limited to only shallow penetration. But they

**Designed for deep concealment, the AMT .45 ACP BACK UP DAO is the smallest available semiauto handgun envelope for the powerful .45 ACP cartridge.**

still make only a very small hole and, if possible, head shots are more likely to incapacitate than torso hits. Europeans prefer the .32 ACP (7.65mm) round over the .380 ACP (9mm Kurz) for no other reason than most pocket pistol series chambered for both rounds provide one more round in the .32 ACP magazine. In my opinion, no effective .32 ACP ammunition is currently available. Only Hornady and Federal produce effective hollow-point .380 ACP ammunition. Even at that, the .380 ACP round

# n

remains no more than marginal in wound ballistics potential. There are a few, very few, extremely compact pistols chambered for the 9mm Parabellum cartridge. They will do, but what if there was an incredibly small, extremely reliable semiauto pistol available for the mighty .45 ACP round?

## Compact, Powerful, Reliable

It appears that there now is such a handgun, and although jaded after years of examining too many less-than-medioere firearms, I have never been more excited about a tiny terminator than I am about the .45 ACP BACK UP DAO (Double Action Only) pistol recently introduced by AMT (Arcadia Machine & Tool Inc., Dept SOF, 6226 Santos Diaz St., Irwindale, CA 91702; phone: 818-334-6629, fax: 818-969-5247). Harry Sanford, AMT's president and architect of the legendary .44 Auto Mag Pistol (AMP), which commenced series production in 1971, and his designer, Larry Gross-

man, have come up with a pistol chambered for the .45 ACP cartridge in an envelope no larger, except for thickness, than the Walther PPK. And it is reliable, all the time, every time, with an amazing assortment of .45 ACP ammunition.

Simplicity is a hallmark feature of this pistol: Counting every screw, pin and spring, there are only 31 total parts. But, most impressive are the dimensions. Overall length of the .45 ACP BACK UP DAO is only 5.7 inches. The height is 4.1 inches and the width, at the grip panels, is 1 inch. The weight, empty, with the magazine is 23 ounces.

Both the frame and slide are mill-finished investment castings made from 17-4 stainless steel (the same

material used to make the frame of the original "Pasadena" .44 AMP). Most of the small components are fabricated from either 17-4 or 17-7 stainless steel. The barrel, with an overall length of 3 inches, has six-groove rifling with a right-hand twist of one turn in 10 inches. It is made of 416 stainless steel. Except for the polished sides of the slide, the exterior of the pistol has a matte, glass-beaded appearance. Both black, glass-filled nylon grip panels are attached to the frame with two screws turned into threaded holes in the frame without a bushing interface. The trigger guard is undercut where it meets the frame's front strap to provide a better grip on the compressed frame and bring the firing hand closer to the bore's axis to reduce the perceived recoil.

The method of operation is locked-breech, short recoil. There is a single, semicircular locking lug inside the slide just in front of the ejection port. When in battery, this lug engages a recess in the barrel 1.4 inches from the muzzle (cut on a lathe around the entire outer circumference of the barrel for cost-effective purposes). A lug on the barrel's underside has been cut with a heart-shaped, forward- and upward-sloping camway. The takedown pin, held by each side of the frame, goes through this cutout. As the barrel and slide — locked together — travel rearward a distance of only 0.105 inches, the barrel starts to cam

downward by means of this pin, unlocking it from the slide and terminating its rearward movement. A raised, concentric ring around the barrel's muzzle takes the place of a conventional front barrel bushing and eliminates the requirement for a separate component. The polished front surface of the lug on the barrel's underside serves as a feed ramp. A single-coil recoil spring rides on a full-length guide rod. The U-shaped end of the guide rod impinges against the front of the takedown pin. All of this is very simple and very effective.

The slide's ejection port is open about 200 degrees around the top of the barrel to enhance reliability and reduce the chance of a "stove-pipe" stoppage. The spring-loaded extractor bar pivots on its retaining pin located on the right side of the slide. The slide's cocking serrations are deeply cut and provide an excellent purchase to draw the slide rearward when chambering a round. The fixed ejector is held in place to the left interior of the frame by the hammer's axis pin.

The trigger mechanism is also quite simple. Pulling the trigger, which pivots on an axis pin in the frame, draws the spring-loaded trigger bar forward. A hook at the rear of the trigger bar pulls the bottom of the hammer forward and the hammer then rotates fully to the rear before it falls forward to strike the spring-loaded firing pin (held in place by a roll pin



Diminutive AMT .45 ACP BACK UP DAO holds six rounds of .45 ACP ammunition. Modern, expanding JHP bullets driven at moderate velocities provide effective wound ballistics potential for this venerable round and maintain its position as the best choice in handgun calibers.

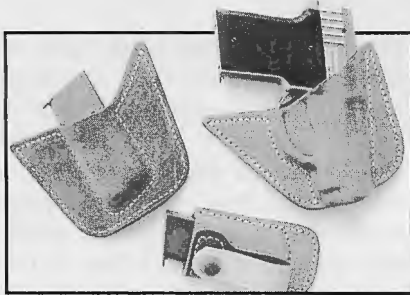

Milt Sparks' #PCH (Pocket Concealment Holster) is ideal for carrying AMT .45 ACP BACK UP DAO in front strong-side pocket. Two magazine pouches, slightly shortened for AMT's five-round magazine, complement the #PCH holster: One is equivalent of the #PCH and designed to be worn in the front weak-side pocket; the other pouch is a modified Sparks #3MC single-cell type and companion piece to the Summer Special inside-the-pants holster.

in a transverse hole in the slide). The trigger has a constant radius configuration and is canted forward at the bottom (a bit too much so for my taste) to increase the travel and thus reduce the pull weight. Trigger pull weight on *Soldier Of Fortune's* test specimen was a relatively smooth 12.5 pounds (as measured with competition dead weights). When the slide travels rearward in recoil, the hammer is rolled back again. When the slide moves forward in counter-recoil, the hammer rides on the end of the slide so that it does not impact on



A raised, concentric ring around the barrel's muzzle takes the place of a conventional front barrel bushing and eliminates the requirement for a separate component. Locking lug in the slide engages recess cut around the entire circumference of the barrel. Note heart-shaped, forward- and upward-sloping camway on barrel's underside lug — used to unlock barrel from the slide at the appropriate time during the recoil stroke.

the inertia-type firing pin with enough force to ignite the primer of the round in the chamber. The hammer spring rides on a strut in the rear of the grip frame. This spring is also employed to spring-load the magazine catch/release as the bottom of the hammer strut rests in a hole in the top of the catch/release button.

To enhance concealment, external protrusions have been eliminated to whatever extent possible. There is no manual safety or decocking lever as this pistol is double-action-only. Even the hammer is shrouded throughout its rotation by the slide and frame. There is no slide stop lever and the slide does not hold open after the last shot has been fired. There is no magazine catch/release button aft of the trigger guard. A European heel-type magazine catch/release is employed and the sharply serrated button, which

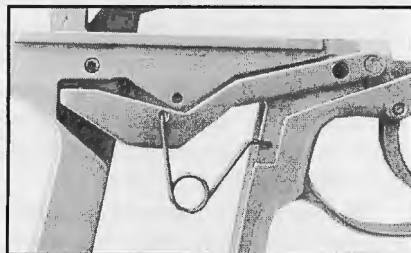

AMT .45 ACP BACK UP's trigger mechanism is quite simple. Pulling trigger draws spring-loaded trigger bar forward. A hook at the rear of the trigger bar pulls the bottom of the hammer forward, rotating it fully to the rear before it falls forward to strike the firing pin.

rotates on a cross pin at the bottom of the frame to the rear of the magazine-well, must be pushed rearward to withdraw the magazine — it does not fall freely away. I cannot envision any realistic scenario in which an operator would be required to effect a tactical reload with a last-ditch handgun of this type

### Deep Concealment

No front or rear sight rises above the slide to snag on clothing. Instead, a channel-type sighting system, consisting of nothing more than a U-shaped groove, runs the full length of the slide. The top of the slide is rounded and all sharp corners and edges have been removed on both the slide and frame.

The single-column, detachable box-type magazine holds five rounds and is manufactured for AMT by Metalform. This is a shortened version of their standard M1911-type magazine, although in this instance the catch/release notch on the magazine body and the hold-open step on the follower serve no function. The magazine body, a welded sheet-metal stamping, is fabricated from 410

stainless steel. AMT modifies these magazines by tapering the feed lips 15-20 thousandths of an inch where the cartridge releases. With a round in the chamber, the total capacity of this pistol is six rounds. There is no magazine disconnect safety on this pistol, so it can be fired with the magazine removed.

To protect themselves from liability lawsuits, the AMT instruction manual cautions users from carrying the .45 ACP BACK UP with a round in the chamber. Provided the operator is an experienced armed professional and consistently follows the four rules of safety — 1) Every gun is always loaded; 2) never let the muzzle cover anything which you are not willing to destroy; 3) keep your finger off the trigger until your sights are on the target, and 4) always be sure of your target — this pistol should always be carried with a round in the chamber, ready to employ instantly should it be necessary to do so. Attempting to manually chamber a round during the drawstroke sequence, under stress, would be cast-

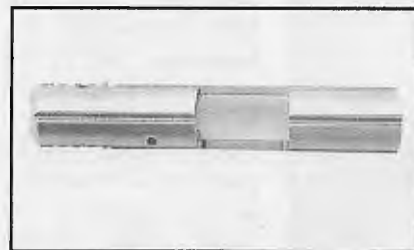

To enhance concealment, external protrusions have been eliminated to whatever extent possible. No front or rear sight rises above the slide to snag on clothing. Instead, a channel-type sighting system, consisting of nothing more than a U-shaped groove, runs the full length of the slide.

ing the odds heavily in your opponent's favor.

The instruction manual also states that it's not necessary to disassemble the .45 ACP BACK UP for normal cleaning and lubrication. Don't believe that either. Proficiency with a small pistol of this type requires a great deal of practice. Anyone who fires a handgun extensively and then does nothing more than swab down the barrel and spray oil on the exterior before stuffing it into a holster, deserves to lose the gunfight and most likely will.

Disassembly of the .45 ACP BACK UP is a piece of cake. Putting

## AMT .45 ACP BACK UP DAO SPECIFICATIONS

|                               |   |
|-------------------------------|---|
| <b>Caliber:</b> .....         | .45 ACP.  |
| <b>Operation:</b> .....       | Locked breech, short recoil. Double-action-only trigger mechanism.  |
| <b>Weight, empty:</b> .....   | 23 ounces with magazine.  |
| <b>Overall length:</b> .....  | 5.7 inches.   |
| <b>Height:</b> .....          | 4.1 inches.   |
| <b>Width:</b> .....           | 1 inch, at the grip panels.   |
| <b>Barrel:</b> .....          | Six-groove with a right-hand twist of one turn in 10 inches. Fabricated from 416 stainless steel.   |
| <b>Barrel length:</b> .....   | 3 inches.   |
| <b>Feed mechanism:</b> .....  | Five-round, single-column, detachable box-type magazine.  |
| <b>Sights:</b> .....          | Channel-type sighting system: a U-shaped groove running the full length of the slide.   |
| <b>Furniture:</b> .....       | Black, glass-filled nylon grip panels.  |
| <b>Finish:</b> .....          | Matte frame and slide investment castings made from 17-4 stainless steel; polished sides on slide.  |
| <b>Price:</b> .....           | \$399.99, complete with one magazine.   |
| <b>Manufacturer:</b> .....    | Arcadia Machine & Tool Inc., Dept. SOF, 6226 Santos Diaz St., Irwindale, CA 91702; phone: 818-334-6629, fax: 818-969-5247.  |
| <b>T&amp;E summary:</b> ..... | Smallest available semiauto envelope for the .45 ACP cartridge. Designed for deep concealment with external protrusions eliminated to whatever extent possible. Reliable with acceptable accuracy at handgun combat ranges. Highly recommended for high anxiety environments. |



**AMT .45 ACP BACK UP DAO, detail stripped.**

it back together is another matter. Remove the magazine and jack the slide to clear any round in the chamber. Pull the slide rearward until the disassembly notch on the left side is aligned with the large head of the



**Much smaller than the M1911A1 pistol and no larger than a Walther PPK, the AMT .45 ACP BACK UP DAO provides .45 power in a .380 package.**

takedown pin on the left side of the frame. Insert a punch of the correct size in the exposed hole in the trigger bar on the right side of the frame (the trigger bar is exposed for this very reason and so that the right grip panel does not have to be removed to separate the slide and frame groups) and push the takedown pin to the left until it is separated from the frame. Push the slide group forward and separate it from the frame. Remove the recoil spring and guide rod from the slide by pushing them forward and then up. Remove the barrel by lifting it up at the rear end and pulling it rearward at the same time. With a screwdriver, remove the grip panels. Lift out the trigger bar spring and then the trigger bar from the left side of the frame. No further disassembly is advisable.

During the cleaning process be sure to remove debris from the breech face and extractor claw with a brush. Before reassembly, all stainless steel firearms must be properly lubricated. There are a number of lubricating oils that have been formulated for stainless steel weaponry. A very thin film of oil should be placed on all of the

interior components. In addition, a film of a more viscous substance, such as Kleenbore's TW25-B High Tech Lubricant, should be applied to the bearing surfaces on the slide and frame.

Reassemble in the reverse order. Be sure the trigger bar's hook is properly engaged behind the hammer. Re-install the right grip panel immediately after you insert the trigger bar spring into its holes in the frame and trigger bar. Install the slide group on the frame and pull the slide rearward until the end is flush with the end of



**Harry Sanford, AMT's president, was responsible for designing the legendary .44 Auto Mag Pistol, which commenced series production in 1971.**

the frame. Before attempting to insert the takedown pin, pray for divine assistance. Push the takedown pin inward from the left side of the frame until its head butts up against the slide. Retract the slide until the disassembly notch is aligned with the head of the takedown pin. If the takedown pin is not perfectly aligned,

*Continued on page 61*

**Three names below** —Robin James, Joe and Chuck Ivey — are fictitious, because the men, all U.S. residents, weren't charged with any crimes. All other names are real. All quotes not attributed to specific documents are from tape recordings.

When Robert W. Muir first talked with Mickey Downie on 25 February 1990 about doing business, Muir and



Former Customs undercover operative Mickey Downie displays part of the tapes and documents he accumulated during six months work on Operation Leatherneck. Treasury Department's Office of Foreign Assets Control was unable to cover up its sabotage of Leatherneck, as Downie kept copies of virtually every evidentiary document he obtained. Photo: James L. Pate

his partner, British SAS veteran Stephen Percival, were in a Hong Kong hospital: A crude bomb had exploded under their Chinese taxi. They miraculously escaped serious injury. Muir told Downie in the brief phone conversation from the hospital that they would have to talk later.

The taxi bombing comes with the turf, Downie told *Soldier Of Fortune*: "That kind of thing happens from time to time in this business."

"This business" is weapons. Big weapons. Lots of big weapons.

Muir and Downie were negotiating a \$70 million deal that included hundreds of thousands of M16s, Thompson SMGs, AK-47s and Colt .45s, all left behind in Vietnam. The list Muir telefaxed to Downie from his home in Bangkok also offered

105mm and 155mm howitzers, with ammunition; M113 APCs, Huey helicopters, C-130 cargo planes, M41 and M48 tanks, and F-5 and A-37 jets.

What Muir did not know was that Downie, a career arms merchant, was also secretly working for U.S. Customs, and that Downie was engineering a sting as part of a Class I undercover investigation supervised directly by the Treasury Department's Office of Foreign Assets Control (OFAC) — Operation Leatherneck. Leatherneck perhaps took its name from the fact that three of the four targets of the investigation in the United States, one an elected federal official, were Marine Corps veterans who'd served in Vietnam. The scheme hinged on using the POW/MIA issue as a cover for buying weapons, armored vehicles and aircraft from Vietnam's communist government.

What Downie in turn could not have known was that the Treasury Department would pull the plug on the operation and hang *him* out to dry.

At the time — 1990 — It was a \$70 million *illegal* deal, one violating the Trading With The Enemy Act. Downie told Muir part of the weapons would be smuggled into the States for sale to street gangs and other criminal organizations. The remainder was going to "other customers," including

the Libyan government. Muir was unmoved by the potential end-users of the deadly toys he was brokering.

The United States did not normalize diplomatic relations with Vietnam until April 1994. The questions readers must consider are these: Why would the Treasury Department — engaged as it is today in a vendetta of intimidation and coercion against law-abiding gun dealers — five years ago sabotage investigation of a blatant plot to smuggle millions of dollars worth of illegal weapons into this country? Why would the

same high-ranking treasury officials try to destroy the careers and endanger the lives of honest people who have tried to right the wrong of Operation Leatherneck?

Muir recovered from his bombing injuries and was back in Bangkok when he and Downie talked on 18 March 1990. But Muir was stinking drunk and they "had a few harsh words," Downie dead-panned in characteristic understatement. "It sounded like you had one or two more than you needed to," Downie told Muir when Downie called Bangkok again the next day, their entire conversation tape-recorded.

"About a bottle more," said Muir, still nursing a hellish hangover. Muir assured Downie that Joe Ivey — Downie's ostensible business partner, actually an unwitting informant and one of the suspects under investigation by Customs — would have no trouble traveling on short notice to either Thailand or Vietnam, where Ivey was to inspect the merchandise. "The ambassador from Thailand to Vietnam is a good friend of mine," Muir said. "I can get that [visa] with no problem. The Vietnam visa he already has. It's sitting in the airport, waiting for him."

Initially, Muir had tried to cut a *legal* deal on behalf of the Vietnamese government. In a 15 September 1989 letter to General Phan Khu, director of the Industry Department of Vietnam's Defense Ministry, Muir advised that he had met with "the



As Downie brought pressure on Feds over their cover-up of Leatherneck, they fought back by blowing his cover on separate cases in Ohio and Tennessee, jeopardizing his life and that of his family. While they searched for him, he was hiding under their noses — seen here at one *SOF* interview location, a penthouse patio overlooking FBI headquarters in Washington, D.C. (Customs HQ is three blocks away). Downie is looking for work — if you need an operative with guts and integrity, write *SOF*. Photo: James L. Pate

appropriate officials of the American embassy in Bangkok” because “it was felt that offering this for sale back to the United States ... would go a long way to improve relations between Vietnam” and the United States. Muir told Phan Khu that when embassy officials rejected it, “we traveled to America in an attempt to get a positive reply from higher officials.

“Receiving no reply, we filed a report with the American Embassy that we would attempt to place the weapons in the hands of a neutral country that would be acceptable to both Vietnam and America,” Muir’s letter to the communist official continued. “After many trips and meetings in Hong Kong, Taiwan and Vietnam, we were ready to proceed with the project. ... Taiwan wished to purchase the entire list presented to them. We then assembled all of the people in Hong Kong from the purchasing mission. We arrived in Ho Chi Minh City on June 10. ‘For political reasons,’ the negotiations were canceled. ...”

The most likely “political reason” was Vietnam’s unwillingness to risk the hoped-for resumption of diplomatic relations with the United States by openly engaging in an arms deal involving U.S. weapons, which Uncle Sam would not sanction.

Indeed, when Muir returned to Bangkok and advised the U.S. Embassy that Vietnam had gotten cold feet, “three different departments of the American government [Departments of State, Treasury and Justice] had directed that efforts be stopped at once to negotiate the removal of weapons from Vietnam.”

Muir’s letter went on to assure the Vietnamese general that “we want to see the [trade] embargo lifted as soon as possible. Friends inside the American government who share our views

tell us that ... the embargo will be in effect for many months to come. ... As an American, I am forced to retire from active participation. Mr. [Robin James], the American from [a Sunbelt state] is in a position to pursue this project and I lend full support to him.

“We do NOT intend to remove ourselves from Vietnam, or our many, many friends here,” Muir’s letter concludes. “Our company in Bangkok is now doing survey work for American businesses and manufacturing corporations who wish to become estab-

Despite his claims in the letter to Phan Khu to have disengaged himself from the massive arms deal, his March 1990 phone conversation with Downie makes it clear that Muir was still very much a player, and that financing arrangements were ongoing.

“The chairman of the [Hong Kong] bank is well aware of everything I’m doing,” Muir told Downie. “It has his full approval, and there’s nothing illegal in that country about moving that money for what it’s intended for. ... The bank happens to be one of the largest in the world. The chairman of that bank knows me personally and knows exactly what I’m doing.”

Muir had apparently changed his mind on his endorsement of Robin James to broker the deal, however. Muir confided in Downie that he “was not comfortable” with James because “I have done too many things for that man, introduced him to too many people, and he’s fucked me every time.” Muir said James went to Vietnam while Muir was in the hospital in Hong Kong and tried to cut his own deal, but was rebuffed by the Vietnamese.

Rather than fear detection by the U.S. government, Muir seemed contemptuous of it, even to invite it. One of the former U.S. ambassadors to Thailand and he were “pretty good friends,” Muir said.

“I have kept the U.S. government informed,” he told Downie. “I have had numerous meetings, both with the company — the CIA people in the embassy — as well as the political people and the commercial people. The commercial attache has been a friend of mine for 20 years. ... The political people are not happy with me for the length of time I’ve spent in Vietnam.”

Muir bragged that he’d already had three letters from the Treasury Department OFAC saying “they would

# OPERATION LEATHERNECK

**Undercover U.S. Customs agent finds an explosive mix of gunrunners, weapons dealers, corrupt Vietnamese, POW scams and dead bodies — while the Treasury Department hangs him out to dry.**

by James L. Pate

lished in Vietnam. ... I am presently in Ho Chi Minh City, working on several projects. We continue our efforts on behalf of Vietnam, and the Americans who believe as we do. ...”

So, five years before the trade ban on Vietnam was lifted, Muir was representing U.S. companies eager to do business with our old enemy, despite the obvious violations of law. Some of these companies are giant corporations who contribute heavily to national candidates of both the Democratic and Republican parties, firms whose names every reader would recognize, whose products virtually every reader has consumed. Some are recognized worldwide as icons of Western civilization.



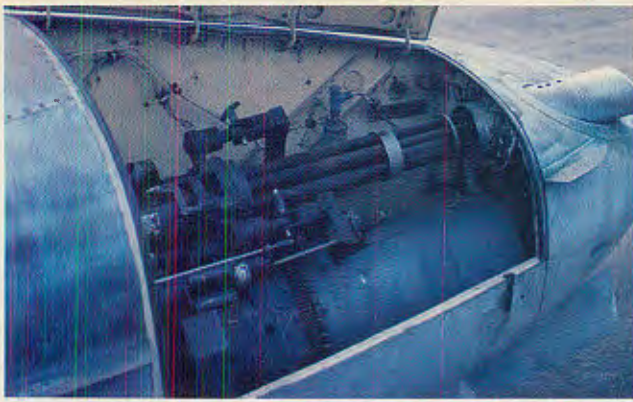

**Military ordnance — lots of military ordnance — abandoned in Vietnam was at the heart of the \$70 million illegal scheme targeted by Operation Leatherneck. Photo: Will Cadence**

jump my ass and seize everything I've got in the U.S. I said, 'Help yourself.' I don't have anything in the U.S. I have no plans of going back for some time to come. At the meeting in the embassy, one of the political guys got his feathers ruffled. He said, 'Fuck it, if you think you're gonna get that stuff outta there! The first ship that comes outta there loaded with those arms, we're gonna grab it on the high seas. Confiscate it! When we find American-made arms with serial numbers that do not jive with anything on the free market, we will simply impound it.'

"I said, 'What the hell! When did you guys become pirates?' I said, 'Okay. Fuck you, too.' And that's where it stood. But ... the commercial attache — his name is mud now at the embassy because of his longstanding friendship with me — told me that they have backed off from that stance. ... I wrote the State Department and told them that I would take such matters as necessary into my own hands in order to move this materiel."

Like any real gunrunner would be, Downie was cautious.

"I am used to making arrangements to get things into the United States," Downie said. "I am used to making arrangements to get things into Canada. I am not used to facing potential problems in between there and here. Can you help me get around that?"

"Yes," Muir assured him. "There's no problem with that. I have your address. I'll write you a letter and take care of problems or headaches on that end from this end. ... But I will not discuss it on the phone."

So Downie cut to the bottom line: money. Let's make a deal, he said.

"I've got customers in place," Downie said. "I've put a lot of time into this and, so far, all I've got to show for it is a tremendous telephone bill."

"I understand that," Muir said. "I've got over \$100,000 invested in this little project. I intend to get it back."

Operation Leatherneck began, of all places, at an Ohio gun show in the fall of 1989. Mickey Downie, who held a federal firearms license to sell machine guns and had a reputation of being a street wise wheeler-dealer, was approached by Joe Ivey, a retired Army logistics officer who claimed to have the connections to buy large quantities of weapons out of Vietnam. Ivey's brother, Chuck, a retired Marine Corps colonel, was an administrative staff member for a U.S. congressman (no longer in office) who had also served in Vietnam in the Marine Corps. Joe Ivey and the congressman were already working with another Vietnam vet, gun dealer Robin James, at opening doors to do business with Vietnam.

Like Muir, the Ivey brothers and the congressman were unaware of Downie's *real* business. At that time, Downie had already worked for four years as a contract undercover operative for the BATF, and for almost a decade after that with U.S. Customs. Downie's control agent for that entire 14-year period was Frank Caliendo. Downie's business as a machine-gun dealer — and his big-city hustler persona — sometimes attracted criminals, which made him a great intelligence resource for federal law enforcement.

Caliendo, whose wife was the third woman to be sworn in as an ATF special agent, gradually grew disenchanted with ATF's increasingly abusive attitude toward law enforcement. He ultimately became a whistle blower, and his wife finally resigned from ATF because of constant sexual harassment. (The Caliendo couple were both interviewed on camera for a CBS News *60 Minutes* segment about blatant sexual harassment by

the ATF, broadcast shortly before the ill-fated Waço raid.) Four years after recruiting Downie, Caliendo transferred from ATF to U.S. Customs, taking Downie with him.

When Downie told Joe Ivey he was eager to broker illegal weapons from Vietnam, Ivey introduced Downie to Robin James, who flew from Ohio for a dinner meeting where Downie introduced them to another supposed weapons broker, who in reality was Caliendo. Downie told *SOF* this was the only meeting that was not secretly tape recorded because "Frank and I were afraid they might pat us down for a body wire." All subsequent meetings and phone conversations were taped, he said, and both James and Ivey "made it clear that they had high-ranking military and political help from U.S. government officials to facilitate this arms transaction."

By that time, efforts by Muir and James to get a piece of the military action coming out of Vietnam were well under way. In a memo to the commercial attache at the U.S. Embassy in Bangkok — Muir's old buddy — dated 19 April 1989, Muir



**Brokers sought a buyer for millions in planes, choppers, armor and small arms among friendly neutrals — but Libya or a drug cartel or two would also be fine. Photo: Will Cadence**

indicates "unlimited" quantities of "bombs, CBU, all sizes," were available, plus unlimited quantities of mortars, bazookas, 51mm (*sic*) and 90mm recoilless rifles, surface-to-air missile launchers and 50mm (*sic*) machine guns.

"All of the above [available] with unlimited amounts of ammo, bring your shopping list, warehouses full," Muir gleefully noted to the embassy official. Muir also itemized the availability of 15 A-37 jets, seven C-130s, 20 UH-1 Hueys, 107 M41 light tanks in excellent condition, 100 M113 armored personnel carriers, 140 155mm howitzers in excellent condition, and



How much is there? How much do you want! Brokers had some 16 ships available to move a \$70 million mountain of illegal munitions to the first customer with cash — until the deal went sour and the Vietnamese general was snuffed. Photo: Will Cadence

30 CH-47 helicopters with rebuilt engines.

Muir further noted to his buddy at the embassy that “all of this is going to Taiwan. General Win Ha Shuin, logistics and procurement, commanding, is in Washington, D.C., at this time obtaining approval from the U.S. to acquire. *Just between us, they are going to buy, with or without an OK [from the U.S. government].*” Muir’s memo cynically noted that the Taiwan deal was being overseen by “General Chiang, the son of the man that two American presidents have hailed as a great man and leader of the free world.

“I have two days to decide: One, complete the deal w/trip to Taipei as guest of Chiang, or two, turn the whole deal over to the British. ...” Muir’s partner, former SAS officer Stephen Percival, is a British national.

In a letter to the Justice Department dated 17 August 1989, James expressed his “wish to register as a foreign agent for the country of Vietnam,” inquiring “if I can register now or is it necessary to wait until the embargo is lifted. ... I recently returned from Vietnam and they have asked me to contact American companies to see if they are willing to come to Vietnam now to begin negotiations for possible contracts with Vietnamese and American companies after the embargo is lifted. Specific companies Vietnam asked me to contact are oil companies and soft drink/beverage companies. ...”

SOF was unable to determine what, if any, reply James received. But after being given James’ real

name, the name of his company and a copy of his letter, a Justice Department spokesman said records indicate he is not now, nor has he ever been, a registered agent for the Vietnamese government.

On 14 October 1989, Red Carpet Service & Tour Company in Bangkok issued a letter identifying James as a “business associate,” adding that it was “issued upon the request of Mr. [James for] whatever legal purpose it may serve him.”

Red Carpet was the primary agent recognized by the Vietnamese government to arrange travel into

When Downie suggested they might screen the movement of weapons from Vietnam to the United States by shipping them through the Philippines, James claimed that he had “met with General Ramos’ secretary about three months ago. ... I was fucking a woman who was a cousin and I may get contact there. ... In fact, I got her visa cleared to come [to the United States] in January. ... She’s gonna meet me back in Thailand to work for me again.”

In the meantime, the Vietnamese government was dangling other incentives in front of the eager eyes of would-be entrepreneurs like James and Muir: U.S. dog tags. An intelligence source in Washington familiar with Operation Leatherneck told SOF that the two men were “using the POW/MIA issue to open the doors for importing illegal weapons. They were using the issue as leverage to try and pry open the door to a lucrative business market.”

19 APRIL 89, 0730, OFFICE BILL DAWKINS, U.S. EMBASSY, BANGKOK.  
 THE MILITARY HARDWARE NOW BEING DISPOSED OF BY THE VIETNAMESE GOVERNMENT  
 INCLUDES THE FOLLOWING ITEMS:  
 NOMENCLATURE QUANTITIES  
 ~~~~~  
 BOMBS, C.B.U. ALL SIZES UNLIMITED  
 106mm MORTARS " "  
 81mm MORTARS " "  
 BAZOOKA'S " "  
 RECOILESS RIFLES 90mm - 51mm " "  
 S. A. M. LAUNCHERS 40mm - 20mm " "  
 MACHINE GUNS, 50mm " "  
 ~~~~~  
 ALL OF THE ABOVE WITH UNLIMITED AMOUNTS OF AMMO "BRING YOUR SHOPPING LIST, WAREHOUSES FULL"  
 ~~~~~  
 A-37 AIRCRAFT, W/AMMO. 15  
 C-130 HERCULES AIRCRAFT 7  
 UH-1 "HUEY" HELICOPTERS 20  
 ~~~~~  
 M-41 LIGHT TANKS (EX. COND.) 107  
 M-113 ARMOURD PERSONNEL CARRIER 100  
 155mm HOWITZER (E. COND.) 140  
 CH-47 CHINOOK ENGINES, REBUILT 30  
 ~~~~~  
 SPARE PARTS AND ALL THE "AMMO" YOU CAN USE GOES ALONG WITH THIS LITTLE SALE.  
 (C-130'S I HAVE CLASSIFIED AS SCRAP)

Back when principals were attempting to operate within the law, Muir sent this memo to U.S. Embassy in Bangkok advising what the Vietnamese were selling.

Vietnam by tourists — especially Americans. In a telephone conversation with Downie on 27 December 1989, James confided that the tourism agency “is a big front for the [Vietnamese] secret police. ... The head of Vietnamese tourism is a personal friend of mine. ... It’s worked out pretty good, except I haven’t been able to benefit him financially and he hasn’t been able to benefit me financially. ...”

In a cable dated 27 October 1989, Muir’s friend who was a commercial attache in the U.S. Embassy in Bangkok reported to Andre Sauvageot of the Department of State in Washington that Muir and James had obtained letters of support from the legislative director of the congressman for whom Joe Ivey’s brother worked. They outlined “an agreement

Continued on page 65

# TITANIUM

"The **COMPETITIVE** edge. . . "™

\$34 Fits AR-15 & M16 style Rifles

\$21 Fits 1911 pistols

.45 ACP & .38 Super

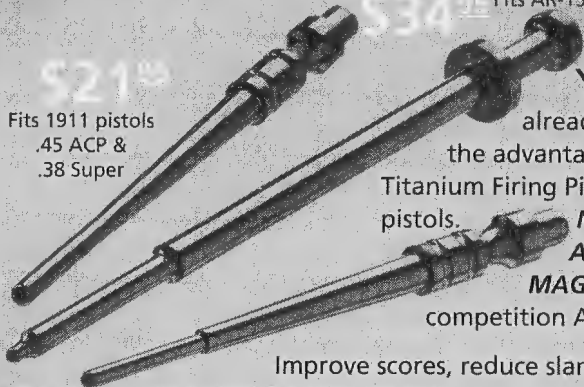

You have already discovered the advantages of our Titanium Firing Pins for 1911 pistols. **NOW YOU CAN ADD THE SAME MAGIC** to your competition AR-15® & M16®.

Improve scores, reduce slam fires, discover what **QUICK** really means!  
Cut lock time . . . & get on to the next target!

Proudly Made in the U.S.A.

Retail order desk:  
1-800-444-1911  
(Add \$3<sup>00</sup> S/H per order)



Quality Machining™

INCORPORATED

"OUR NAME SAYS IT ALL"™

P.O. Box 129 • Sherwood, Oregon 97140

24 HOUR FAX LINE FOR ORDERS & DEALER INQUIRIES: 1-503-590-3637  
(Product Information: 1-503-590-3636)

## PACK

Continued from page 31

circulate over the wearer's back.

To add to the pack's durability, the mesh is doubled or reinforced in some manner or another throughout the structure of the pack. For example, on the bottom and around the entire perimeter of the bag's interior are velcro-type strips. They serve three purposes. They give the pack structural body. They serve as backing for things sewn on the outside of the pack, such as the carrying handle on top. And, they permit the installation of pouches to hold small bottles, medicine and other equipment along the inside of the pack.

Aluminum stays inside the back panel provide the structural integrity of this internal-frame pack. The stays are removable and are encased in pockets fabricated with four-way lash pads sewn to them, allowing accessory straps to be installed. The lash pads permit gear to be attached in a tier-like manner. By this means, I keep a military rain poncho, an Ultralight Therm-a-rest three-quarters self-inflating, insulating air mattress and a waterproof, breathable Bibler ToddTex bivouac sack in the pack at all times. Attached to the inside bottom velcro-type strip is a "Schultz" pack loaded with high-energy bars. This layering of equipment helps to concentrate the cargo on the hip belt rather than the shoulder straps. Although this is only a day-pack envelope, since the load rides on the hips rather than the shoulders, a rifle can be fired from the shoulder in either the off-hand or prone position without interference from the pack. Both the shoulder straps and hip belt are removable and can be stowed in one of the outer pockets so the pack can be used as a brief case or carry-on luggage.

On the inside of the pack's front panel is a full-size pocket with a vertical center zipper for storing maps, gloves and other relatively flat items. There are two large exterior pockets on the front panel with a hidden pocket behind the lower one for storage of a handgun. The entrance to this handgun pocket is hidden by the upper compartment. There is a cordura envelope inside the handgun

# THE FIRST TEAM



# Safari Arms, INCORPORATED

620 - 624 OLD PACIFIC HWY SE • OLYMPIA, WA 98513  
TELEPHONE (206) 459-7940 • FAX (206) 491-3447

**Carry-Comp .45s** now available from **Safari Arms** - with the Wil Schueman-designed hybrid compensator system. Adds no length or significant weight to the pistol, yet drastically reduces recoil.

**Right:** Matchmaster and Enforcer Carry-Comps



**ENFORCER**  
3.8" barrel, coned, no bushing. Stainless, steel or aluminum available.

**MATCHMASTER**  
5" barrel, LPA adjustable sights. **We guarantee accuracy.** Stainless, steel or aluminum.

**CREST RENEGADE**  
4.5" or 5" barrel, LPA adjustable sights. Stainless only.

**At last!** A custom quality left-handed .45 ACP at a reasonable price for **LEFT-HANDED** shooters. Tired of catching hot brass in your teeth? Try the **RENEGADE!**

pocket to conceal the weapon's presence. I store several small bottles, a first-aid kit and MREs in the two outside pockets and most often a Smith & Wesson M629 .44 Magnum Mountain Gun with a 4-inch barrel in the hidden pocket.

On the bottom of the outside of the pack are three more four-way lash pads for securing extra equipment, such as climbing rope. My Mesh Back Attack Pack is equipped with an optional Safepacker holster keeper and four-way lash pad on the bottom and top, respectively, on each side of the pack's exterior. On the left side, using the Safepacker keeper, I have attached a mesh canteen holder (available for either military-type canteens or backpacking-type, one-quart bottles at \$12.95 each). On the right side, using both the Safepacker keeper and lash pad, I usually attach an M16A2 M4 Carbine which has been fitted with the "Giles" Tactical Rifle Sling, also manufactured by The Wilderness. Those less violently inclined can secure skis to the side of the pack.

Fabricated from heavy, 1.25-inch, black nylon webbing with 1.25-inch Delrin buckles, the Giles sling is stitched with heavy polyester thread, which is more sun-resistant than nylon. Made for virtually any shoulder-mounted combat firearm, it can be used as a carry, shooting or hands-free sling (in the manner of the H&K MP5 sling). The model attached to my M16A2 M4 Carbine wraps around the front end of the handguards and is retained at the rear by webbing passing through the two sling slots in the retractable buttstock. Prices vary, but this model costs \$35.

Cordura is a great deal more durable than mesh. This pack is also available made completely of cordura or in cordura with a mesh back panel. The price, with either material and complete with three sets of accessory straps, is \$200. Safepacker keepers are \$19.95 each. A magazine pouch for M16/AUG magazines which can be attached to the hip belt is available for \$24.95. The Schultz pack for holding small bits and pieces costs \$14.95. Optional padded mesh shoulder straps are \$39.95 per set. A larger version of this pack, called the Fast Pack, is also available. It has a heavy padded belt and spine pad with the stay pockets attached to the spine pad. As a consequence, all of the weight

# Rifles & Carbines

## The Heckler & Koch Assault Rifles

### HK Assault Rifle Systems

by Duncan Long

The tough G3 rifle and its huge number of spinoffs has long been a favorite of soldiers, policemen, and civilians. Now firearms expert Duncan Long reveals the little known history behind this fascinating family of weapons, tracing its beginnings from the ashes of WWII to the present. The book goes on to show the probable direction HK designs will take in the future and tells why the G3 and its variants will remain popular during much of the next century. The author also examines customized versions of the .308, .223, and 9mm rifles and submachine guns and semiauto versions as well as other chamberings of the G3 spinoffs (like the HK-91/93/94, SR-9, SAR-3/8, SP-89, etc.). 8 1/2"x11", 128 pages, illus., soft cover

Item No. C-9013.....\$27.95

### HK 91 & 93 Factory Manuals

Yes, here it is! A 52 page detailed manual for your HK rifle. You have just purchased a new or used rifle and did not receive a manual. This one covers operations, maintenance, accessories, etc. Many illustrations, photos, and explanations. 7x8.5, illus, 52pp, softcover. Must specify Model 91 (G3) or 93(HK 33) when ordering.

Item No. C-403 (HK 91, .308).....\$15.95

Item No. C-404 (HK 93, .223).....\$15.95

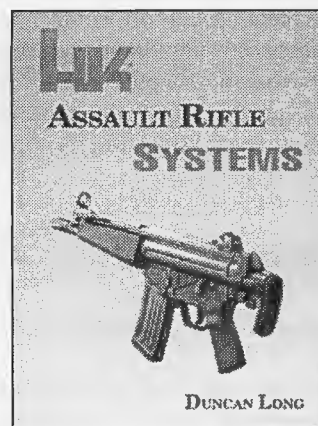

## The Garand & M14

### The Fighting Garand

Everything a Garand owner or user will ever need to know. 8 1/2"x11, softcover, illust.

Item No. C-136.....\$11.95

### The M-14 Rifle

This book is a must for anyone who owns an M-14 or its civilian counterpart, Springfield Armory's great M1A1. 8 1/2"x11", softcover, 50pp., illus.

Item No. C-135.....\$8.95

### M14/M14A1 Rifles & Marksmanship

This manual contains a detailed description of the M14 and M14A1 rifles and their general characteristics, procedures for disassembly and assembly and much more. 236 pp., indexed, 8 1/2"x11", soft cover.

Item No. C-274.....\$14.95

## The SKS Carbine



### The SKS Type 45 Carbine by Duncan Long

The SKS is an enigma in the world of assault weapons. Did it gain its place on the battlefield because of politics or performance? Has it survived because it is cheap to construct, or does it stem from its functionality and reliability?

Duncan Long reveals the answers to these questions and many more, beginning with the history of the SKS and advancing to the practical aspects of operating, maintaining and modifying this abundantly available rifle. 5 1/2"x 8 1/2", 110 pages, photos, and softcover.

Item No. C-9047.....\$14.95

## More Rifles & Carbines

C-211 FN-FAL Auto Rifles Manual .... \$13.95

*Illustrated, photos, 5 1/2"x8 1/2", 130 pages.*

C-822 Mini-14 Super Systems ..... \$16.95

*Illustrated, photos, 5 1/2"x8 1/2", 189 pages.*

C-333 USMC AR-15®/M16A2 Man. ... \$16.95

*Illustrated, photos, 8 1/2"x11", 264 pages.*

Credit Card Orders Only call our  
Toll-Free Order Line  
**1-800-852-4445**

Customer Service  
1-501-862-4984

Fax Number 1-501-862-9671

**Allow 2 weeks for delivery**



Call for dealer info.

Add \$4.95 S&H to all orders plus an additional \$3.00 for orders to Canada. Other foreign add \$12.00 for first item & \$2.00 for each additional item.

Send Check or Money Order to:

**DELTA PRESS**  
P.O. Box 1625 Dept.SF43  
El Dorado, AR. 71731

Send \$4 for a 80 page color catalog (Free with order)

## WHEN YOUR TYPICAL DAY ON THE JOB IS ANYTHING BUT TYPICAL.

LONDON BRIDGE TRADING CO. IS A *manufacturer* OF TACTICAL LOAD-BEARING AND OTHER SPECIALIZED EQUIPMENT FOR: BUILDING ENTRY, SNIPER/COUNTER-SNIPER, SURVIVAL, ESCAPE AND EVASION.

OUR GEAR IS USED WORLDWIDE

BY MILITARY SPECIAL OPS UNITS, GOVERNMENTAL AGENCIES AND SPECIAL LAW ENFORCEMENT UNITS. RETAIL AND WHOLESALE ACCOUNTS.

Send \$2.00 for our extensive catalog.

STORE HOURS: M-F 9:00-7:00.  
SAT. 12:00-6:00. • 804-498-0207



**LONDON BRIDGE TRADING CO. LTD.**

3900 BONNEY RD., STE. 107  
VA. BEACH, VA 23452 USA

1-800-229-0207  
FAX 804-498-0059

of the racking system is transferred directly to the spine pad. This lowers the perceived weight by about 30%.

The Mesh Back Attack Pack is ideal for day hikes, short overnight trips and both military and law enforcement special operations. This is professional equipment designed by a company with a proven track record in this area. I can recommend it highly without reservations of any kind. ✂

## GEER ON GEAR

*Continued from page 39*

pocket for the knife; this also makes wearing a sheath unnecessary.

The *River Shorty* is Gerber's affordable new multi-function dive/whitewater river knife. The *River Shorty* fills many needs associated with these two water sports, including a handy chisel point for prying and a serrated edge for cutting rope and synthetic materials.

The stainless steel blade also features a serrated thumb grip allowing greater force to be applied without

slipping, and the knife's hard-molded handle is deeply textured for a secure grip. And it has a lanyard hole so it may be tethered to the diver/rafter.

For more information, contact Gerber Legendary Blades, Dept. SOF, 14200 S.W. 72nd Ave., Box 23088, Portland, OR 97223; phone: 800-950-6161; fax: 503-684-7008.

*Galen Geer is SOF's contributing editor for outdoor affairs. ✂*

## COMBAT WEAPONCRAFT

*Continued from page 18*

and another the more recent *failure drill*.

The Mozambique involves following up the two shots to the body (of any cadence) with a carefully placed, surgical brain shot. The application is when two shots didn't have the desired effect, which occurs often in this age of body armor and drug abuse. Rather than pummel the adversary's desensi-

tized or armored body with bullets, shift to Plan B: Place a single round in the database and turn off the machine.

The classic Mozambique drill calls for dropping the handgun from the line of sight and evaluating the target after the first two shots, to judge if they've worked. If they have not, proceed with the head shot.

One must consciously *slow down and get that hit*. Don't confuse the open-end interval with *unlimited* time, because one still must hit as soon as possible. If you miss — you die! Allowing enough time, within reason, to make the shot encourages the needed marksman's pause.

An advancement on this technique is the failure drill. Whereas the Mozambique drill calls for a distinct shift in gears after the first two shots, proceeding from the evaluation phase to the head shot, the failure drill requires less of a conspicuous lull. Why lower the pistol? If your opponent is still in the sight picture after the first two shots, elevate to the head and fire.



Rhodesian #1003

# AT LAST! The SOF Classic Collection!



H & K #1004

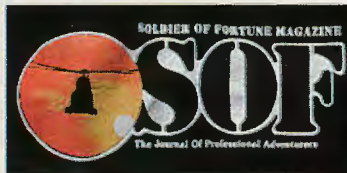

SOF Logo  
Bk #1001

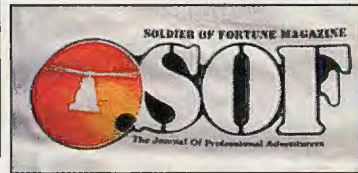

SOF Logo  
W #1002



Polo 50/50  
Bk #1005  
W #1006

Available for a limited time!

Sizes: M, L, XL, XXL

T-shirts: Only \$12.95  
Polo Shirts: Only \$18.95

Name \_\_\_\_\_

Address \_\_\_\_\_

City \_\_\_\_\_

State \_\_\_\_\_ Zip \_\_\_\_\_

Clip and Mail To: Facets  
576 Aztec Drive  
Boulder, CO 80303

Foreign orders add \$10.00 for Shipping

| QTY                                                                                      | ITEM NO. | SIZE | PRICE EA.                 | TOTAL |
|------------------------------------------------------------------------------------------|----------|------|---------------------------|-------|
|                                                                                          |          |      |                           |       |
|                                                                                          |          |      |                           |       |
|                                                                                          |          |      |                           |       |
|                                                                                          |          |      |                           |       |
|                                                                                          |          |      |                           |       |
|                                                                                          |          |      |                           |       |
|                                                                                          |          |      |                           |       |
| *Add \$3.00 for first shirt S&H                                                          |          |      | Sub Total                 |       |
| *Add \$1.00 ea. additional shirts S&H                                                    |          |      | S & H*                    |       |
| *Add \$1.00 for XXL S&H                                                                  |          |      | 3% Sales Tax              |       |
| MC/VISA <input type="checkbox"/> CK <input type="checkbox"/> MO <input type="checkbox"/> |          |      | (Colorado Residents Only) |       |
|                                                                                          |          |      | TOTAL                     |       |

The next time you hear the imprecise term "double tap," think "two hits per customer." All the above firing modes will come to mind. How those hits are delivered and what happens afterward needs to be considered, and practiced, before the fight occurs.

Those destined to win study first, then fight. Those destined to lose fight first, then (if they're still alive) study why they've lost.

*Gabriel Suarez is a full-time police officer in Southern California where he conducts training through the Front Sight Training Institute. ✕*

## LITTLE BIG GUN

Continued from page 53

it cannot be re-installed. I found that a wooden dowel was useful for pushing against the head of the pin to adjust its alignment.

A pistol of this type is designed for deep concealment. There are only

a few viable alternatives. Groin holsters provide concealment at the expense of access. If your primary sidearm is carried on the belt, it makes little sense to attach a backup to the other side of the belt. A lightweight, stripped-down shoulder holster, such as the City Slicker by Ken Null, or ankle holsters by any number of custom makers are satisfactory options. However, presentation from an ankle holster telegraphs your actions to a potential opponent.

In my opinion, the .45 ACP BACK UP DAO has the perfect envelope for carrying in a well-designed pocket holster. Milt Sparks Holsters Inc. (Dept. SOF, 605 E. 44th, #2, Boise, ID 83714; phone: 208-377-5577, fax: 208-376-7386) is a small custom shop that has, for more than two decades, specialized in supplying armed professionals with leather goods. Their clientele has included such highly regarded notables as Jeff Cooper, Elmer Keith, Mel Tappen and Ken Hackathorn. I can personally recommend their rigs without reservations of any kind.

Their #PCH, Pocket Concealment Holster, is ideal for carrying the AMT .45 ACP BACK UP DAO in the front

strong-side pocket — a perfect location for me as I carry my primary piece on the weak-side in a Sparks #55BN crossdraw holster. Made from top-quality cowhide and carefully hand-molded, the #PCH is constructed with the rough-side out so that it will stay in the pocket when the pistol is drawn. A pointed flange at the top rear of the #PCH will catch the inside of the pocket if the pistol is drawn with a slight rearward motion, further aiding the holster's retention in the pocket. It also features a slight rearward muzzle cant so that the pistol's butt is raised up for a more accessible grip during initiation of the drawstroke. This superb little holster costs only \$35. Remember, holsters of this type are not built for speed draws. They're designed to 1) modify a pistol's configuration and inhibit it from "printing" through the clothing, and 2) prevent it from rotating about in your pocket so that you cannot reach the grip frame.

Tony Kanaley, a co-owner of Milt Sparks Holsters, also provided us with two magazine pouches to complement the #PCH pocket holster. Both were shortened somewhat to accommodate

# NIGHT OPERATIONS SPECIALIST Now You Can Own The Night!

## SHOPPING LIST

- a \_\_\_ Night Vision Goggles (NVG)
- b \_\_\_ Aviation NVG - ANVIS
- c \_\_\_ NVG Magnetic Compass HUD
- d \_\_\_ Night Vision Binoculars
- e \_\_\_ Night Weapon Sights
- f \_\_\_ Night Photography Scopes
- g \_\_\_ Laser Weapon Aimers
- h \_\_\_ IR Flashlight Filters
- i \_\_\_ IR Chemical Lights
- j \_\_\_ IR "Fireflies"

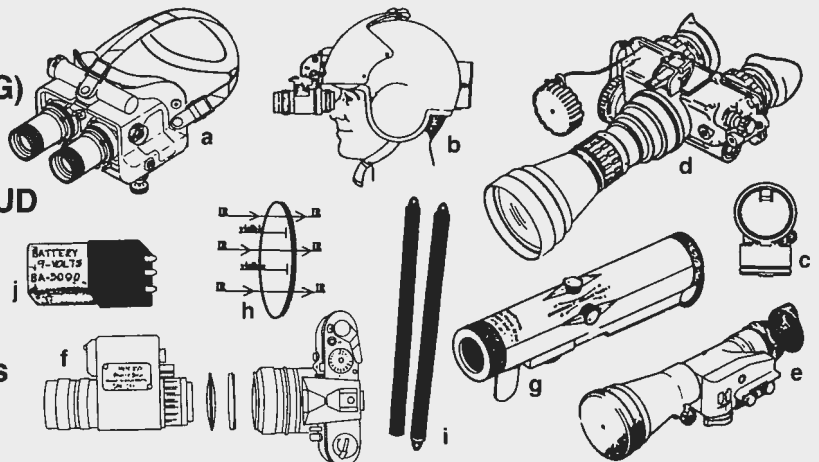

Call for FREE Product Listing or send \$4.00 for complete catalog!

### FFL DEALERS CALL FOR SPECIAL SAVINGS & NEW PRODUCTS!

1. Our night vision systems are manufactured using the finest in NEW components and image intensifier tubes.
2. Our image tubes are MADE IN THE USA by a major manufacturer of night vision systems for the US Military (no Russian surplus).
3. Our systems are WARRANTED for TWO FULL YEARS.

WORLD'S LARGEST STOCKING DISTRIBUTOR OF U.S.-MADE NIGHT VISION EQUIPMENT!

**EXCALIBUR ENTERPRISES, P.O. BOX 400, FOGLESVILLE, PA 18051-0400**  
**(610) 391-9106 Special equipment for NIGHT OPERATIONS FAX (610) 391-9223**

# the FIELD FIGHTER I & II

designed by  
Robert K. Spear



Featured in the "Rogue Warrior" novel series by Rick Marcinko & John Weisman, this is the most effective fighting and field knife combination in the world. The Field Fighter is simply the nastiest, most practical blade you can hang on your web gear. This newly redesigned, hand-made version is spring steel with selectively tempered edges. It stays sharp, yet it is resilient to hard use and abuse. This may be the only big knife you'll ever need. The FF I is \$190, the FF II is \$180. Sheath & fighting manual included. Add \$6 S&H. For info contact: UFD-SOF, P.O. Box 410, Leavenworth, KS 66048

## ITS GROUNDHOG DAY!

For those of us living under the shadow of gun control...  
Hide your weapons *WHILE YOU CAN!*

### GROUNDHOG™ UNDERGROUND STORAGE SYSTEMS

**GROUNDHOG™** the only container available today that will accept the AR15-M16 family of weapons without disassembly; at 58"x10" (@5 feet/4554 cubic inches), the **Groundhog™** easily holds four AR15's, two AK-47's and 2300 rounds ammo, with plenty of extra room for handguns or anything else you want to safeguard! Largest underground storage safe available today at a reasonable cost!

**GROUNDHOG, JR™** at 58"x8" (2914 cubic") holds four AK-47's and 1500 rounds ammo. **GROUNDHOG™ AMMO SAFE** (40"x10") Holds *three* standard military ammo boxes! **GROUNDHOG, JR™ AMMO SAFE** (40"x8") to store handguns and other valuables.

\*Airtight, watertight, nonmagnetic subterranean safes\*

\*Half pound desiccant included for added moisture removal/absorption\*

\*Heavy-duty PVC materials \*Built in the USA\*Complete instructions included.

**DON'T LET THEM BURY YOUR RIGHT TO KEEP & BEAR ARMS**

Groundhog™.....#GH1.....\$94.95    Groundhog, JR™.....#GH2.....\$59.95  
Groundhog Ammo Safe™...#GH3...\$64.95    Groundhog, JR. Ammo Safe™...#GH4...\$44.95  
Extra Desiccant (Half lb.).....#GH5...\$4.95

Shipping \$15.00 for GH1&GH3 and \$10.00 for GH2&GH4 to lower 48 states  
Send for your **Groundhog™** Safe using Check, Money Order or call for VISA/MasterCard orders.  
Free 144 page color catalog with order!

N.I.C., Inc.--PO Box 5950-Dept. FGH  
Shreveport, LA 71135-5950  
CALL (318)688-1365 or FAX (318)688-1367



the .45 ACP BACK UP DAO's five-round magazine. One is the magazine pouch equivalent of the #PCH. Designed to be worn in the front weak-side pocket, it has the same features and price as the #PCH. Because it was shortened, Tony added a flange on the bottom of the pouch to prevent it from rolling out of the pants. The other pouch is a modified Sparks #3MC single-cell type which is the companion piece to the Summer Special inside-the-pants holster. This rough-out pouch has a metal reinforced top band and one-way, snap-fastener on the belt loop and costs only \$22.

Reliability must be a backup pistol's most important single virtue. It will only be used when you are desperate. You must be able to dump every round that it contains into the target's vital areas without failures of any kind. A stoppage clearance drill performed during the kind of high anxiety situation that requires employment of a deep concealment backup will not go smoothly.

In an attempt to confound the AMT .45 ACP BACK UP DAO we mixed ammunition from seven lots and types during our 500-round test and evaluation. We used .45 ACP rounds from Black Hills Ammunition (Dept. SOF, P.O. Box 3090, Rapid City, SD 57709; phone: 605-348-5150, fax: 605-348-9827) of four types: 230-grain Full Metal Jacket (FMJ), 230-grain Round Nose Lead (RNL) reloads, and both 185-grain and 230-grain Hornady XTP Jacketed Hollow Points (JHPs). Also included in the performance test were Norinco 230-grain FMJ and Cor-Bon (Dept. SOF, 4828 Michigan Ave., Detroit, MI 48210-0126; phone: 800-626-7266, fax: 800-923-2666) 230-grain +P JHP ammunition, and my own 230-grain RNL reloads propelled by 6.3 grains of Hercules Unique.

At the initiation of *SOF's* test and evaluation there were two failures to go into battery and I had to slap the end of the slide to force it forward the last eighth of an inch. Subsequently, there were no stoppages of any kind no matter how we mixed cartridge types in the magazine. I think the barrel's integral feed ramp is partially responsible for this high degree of reliability with such a diverse assortment of bullet configurations.

The Cor-Bon box indicated a velocity of 950 fps and this ammunition was used to measure the velocity drop

## Siber Optics Night Vision Scopes

Brand New!



- High Tech
- Compact
- See clearly for ¼ mile
- Image Enhancer — “see in **total** darkness”
- Formerly “Top Secret” Russian military equipment

### — “Also Available” — Miniature Spy Device

- Palm sized monocular
  - Very effective for clandestine observation
- “Competitive Prices”



### 2 yr Unconditional Warranty

For orders & information:

(202) 783-0958 or 1-800-309-1236

24 hr fax line:

(202) 783-1839 Visa/MC accepted

Siber Optics

733 15th St. N.W. Suite 410

Washington, D.C. 20005

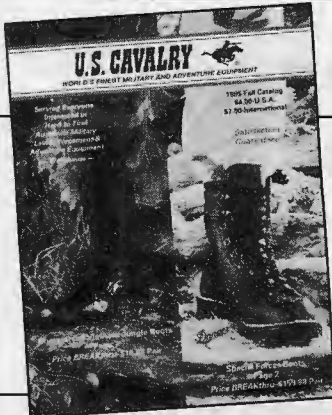

## Target to Adventure!

U.S. Cavalry has everything you'll need for your adventurous lifestyle! Over 120 full-color pages loaded with shooting accessories, knives, hi-tech optics, camping and survival gear, GPS's, official and tactical uniforms, communication equipment, flashlights, boots, military memorabilia, personal protection devices, target practice aids and much more. **Guaranteed 100% satisfaction!** For your catalog, send your name, address and \$4.00 to:

**U.S. CAVALRY** 

Dept. SF 2855 Centennial Ave.  
Radcliff, KY 40160-9000

associated with the .45 ACP BACK UP's 3-inch barrel. Our control for this was a Para-Ordnance P13.45 with a 4.25-inch barrel. Instrumentation consisted of the excellent PACT (Practical Applied Computer Technologies Inc., P.O. Box 531525, Grand Prairie, TX 75053; phone: 800-722-8462) MKIV Championship Timer with its built-in chronograph mode, together with PACT MK5 Professional Skyscreens. We lost only about 30 fps as the velocities (10 feet from the muzzle) from the Para-Ordnance P13.45 and AMT .45 ACP BACK UP were approximately 865 fps and 835 fps, respectively. This is not enough of a velocity loss to affect any handgun bullet's wound ballistics potential.

I had misgivings about the channel-type sighting system prior to our test and evaluation, as I am a Gunsite-trained “front sight, press” shooter. Using the action-shooting mode of the PACT MKIV Championship Timer, we conducted failure drills (two shots to the body and a single shot to the head) and single torso shots from 7 yards on Gunsite's proprietary “option” paper target with a green camouflage background. Again, our control pistol was the Para-Ordnance P13.45. As we had no holster for the .45 ACP BACK UP during the time frame of our firing tests, shooting drills with both pistols were conducted from the “guard” (Weaver ready) position. During the failure drills my times averaged about 0.3 seconds faster (less than 2 seconds) with the .45 ACP BACK UP than with the Para-Ordnance P13.45!

Most gunfights with handguns take place at ranges less than 7 yards. At this distance, the .45 ACP BACK UP pistol is every bit as accurate as larger pistols with conventional sights, when fired under the pressure of time constraints. None of those involved in our test complained about the trigger pull or any additional perceived recoil, which is negligible for experienced shooters firing under stress.

I wish I could find something serious to criticize, as I am not inclined to write puff pieces of the type that fill every page of the popular gun press. However, this clever design has been brilliantly executed and will find great favor with armed professionals. Suggested retail price of the .45 ACP BACK UP DAO is \$399.99, complete with one magazine. ☞

# Lasers

## Engineering Counts!



### Small & Large Frame Handgun Mounting Options

#### Trigger Guard

- Beretta/Taurus
- Browning
- Colt
- Firestar
- Glock
- H & K USP
- Ruger
- SIG
- Smith & Wesson

#### Revolver

- Charter
- Colt
- Rossi
- Ruger
- Smith & Wesson
- Taurus

#### Long Arms

- AR-15 Front Sight
- Rifles & Shotguns

## FEATURES



5mW Max Power, Quick Detachable Laser Sight

Mounts for Revolvers, Semi-Autos, Rifles, & Shotguns

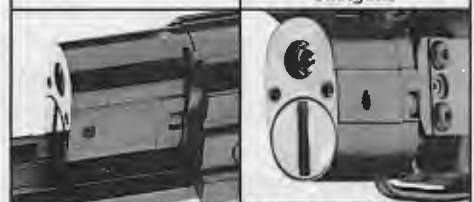

"T"-Slot Mounts Insure Zero-Return

Aim-Lock® on all Sighting Adjustments

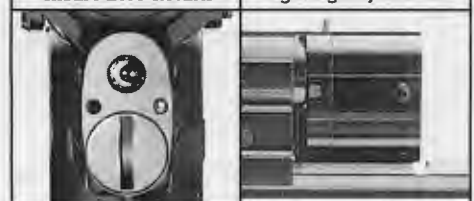

B-SQUARE® Lifetime Guarantee

Switch Options: Integral or Cord

**B-SQUARE**  
1-800-433-2909



## HECKLER & KOCH

Continued from page 49

bipod appear to differentiate the LMG from the rifle. Unless the basic design itself is exceptionally durable, this inevitably casts doubt on its viability in the fire support role. It is certainly no machine gun, and (without a different barrel) would also be marginal as a light support weapon.

The G36/MG36 competition has been pursued with considerable (if not indecent) haste apparently due to political pressure. A 15-month technical evaluation and troop trial of both contenders ended in April 1994 — a rush job by most standards. Sources suggest the rival designs are in a dead heat, though the HK50 has the dual advantage of not only being the home boy, but of handling much like the existing G3.

Bullpups such as the AUG need more familiarization training, and Steyr is offering a training team tailored to tackle any H&K bias. *Mausser Werke Oberndorf* (down the

hill from H&K) would manufacture and assemble AUG components, and *Leitz Wetzlar* would provide the optics. Steyr's newest corporate acquisition, *Jagd und Sportwaffen Suhl*, would also supply some parts, bringing work to the new eastern provinces of Germany.

At last count, a German government decision was expected in late 1994 with initial deliveries beginning in 1995 through 2000. But if there are any delays, sources predict the Bundeswehr could lose its funding, deferring things for another 12 months.

*Nick Steadman is an independent correspondent based in Britain specializing in small arms related subjects. He is also a contributing editor to Fighting Firearms magazine.* ✕

## I WAS THERE

Continued from page 15

flight status. But I'd have exchanged those months in the hospital for 18 months in combat anytime.

Timberlake was awarded the Silver Star and finished his tour of duty with the Crusaders only to return to Vietnam in 1972 as a Cobra pilot with the First Cavalry Division and retire as a major. His pilot was awarded the Distinguished Flying Cross. A small reward for saving so many lives. As far as I'm concerned he and his crew should have been awarded the Medal of Honor. I'm just glad to have made it alive.

Here's to you, Major Timberlake. ✕

## HAITI

Continued from page 35

the largest airborne assault since World War II. Bray, a SpecOps planner during the Gulf War, also oversaw the 82nd jump into Panama.

"It was a very intricate air drop, complicated by the tight valley in which the airport is located. There were multiple drop zones in the valley, which is about 10 miles wide. Our biggest concern was midair col-



At CAUSE Foundation we believe that Janet "child abuse really burns me up" Reno and her black booted henchmen of the BATF should not get away with Waco-like tactics against any more Americans.

**WE want to make it very expensive for them to drive tanks over the Constitution and to set fire to the Bill of Rights.**

In federal court, we have already filed suit on behalf of surviving Branch Davidian family members. We are suing Reno and every one else connected with this atrocity.

**Send your most generous contribution to:**

As a non-profit civil rights organization, we depend on donations from patriots like you. Our supporters are people who want to do something about these problems instead of just reading about them. Won't you join us? Let's make Janet think twice next time she cranks up her tanks.

**Help stop  
Reno  
and her  
Gun  
Grabbing  
Goons**

**CAUSE FOUNDATION  
P.O. Box 1235, Black Mountain, NC 28711**

lisions. Were that to occur, we could have lost almost as many people as were killed during Desert Storm.”

Like Tocumen airport in Panama, the usable DZ was only 10,000 feet long. Jumping from 500 feet can be hazardous under the best of conditions, and jumpers hoped that Spec-Ops would have neutralized any AA.

Many people, including Bray and some of the 82nd, were disappointed the invasion was canceled. “But that doesn’t mean we’re bloodthirsty, or that we wanted anyone to get killed,” he said. “The only way you know if you planned it properly is go out and do it. All of us know it was better that we did not have to invade Haiti, that we had a peaceable entry, rather than a forceable entry.”

Driving back to their staging point in an Air Force van, Bray says there was little conversation. Psychologically, it’d been difficult for planners and paratroopers to relax after being wound as tight as an eight-day clock.

The wounds of Haiti — bleeding, open sores of two centuries standing — may take considerable time to heal. As we go to press the Haitian military and police establishment appear

to have been largely pacified. Cedras made reference to his monitoring elections after Aristide returned. That “misunderstanding” has apparently been resolved with the departure of Cedras and company to Panama. With warring factions disarmed and a multinational peacekeeping force in place, perhaps there is hope for a democratic healing process in Haiti.

Perhaps.

*Senior Foreign Correspondent Dale B. Cooper goes where the troops go. He’s been on the ground for SOF with U.S. forces in the Gulf, Panama, Somalia and Haiti. ✕*

## OPERATION LEATHERNECK

*Continued from page 57*

... indicating their ‘intention to [facilitate] the discovery and releasing to the U.S. government the names and living persons presently in Vietnam.’ ”

But after that perfunctory open-

ing, the cable goes on for nine paragraphs to explain what apparently weighed much more heavily on the minds of Muir and James.

“The political section was advised that Mr. Muir and Mr. [James] wanted to talk about Vietnam and weapons trade,” the State Department cable said. “Mr. [James] indicated that they both had recently returned from Vietnam and had been told by VNG [Vietnamese government] officials that a substantial list of U.S. military weapons would be made available for resale. Mr. [James] would be able to designate one warehouse in Vietnam for all weapons to be collected for cataloging and stamping with some type of identification (This warehouse location would probably be in Long Binh.)

“The list of weapons mentioned that were of interest to Mr. [James] included the following: 400,000 M16 rifles; 250,000 M1 carbines; 500,000 M1 Garands; miscellaneous machine guns (i.e. M60, 30-cal., etc.). Mr. [James] appeared intent on getting approval from Washington, D.C., to buy these weapons for re-sale to ‘friendly’ allies of the USG. He was

# BUILD YOUR OWN FIGHTING SHOTGUN!



**Do It While You Can!!!**

**— ORDER TODAY —  
(314) 669 - 5319**

|                                                                                                                    |         |                                                                       |         |
|--------------------------------------------------------------------------------------------------------------------|---------|-----------------------------------------------------------------------|---------|
| <b>Tactical Grips</b> - (front).....                                                                               | \$18.00 | <b>Jumbo Head Safety</b> .....                                        | \$8.00  |
| (rear).....                                                                                                        | \$15.00 | Fits Remington 870, 1100, 11-87.                                      |         |
| Models to fit Mossberg 500 - 600; Remington 870<br>Winchester 1200 - 1300. Specify shotgun & front or rear.        |         | <b>T-45 Tactical Flashlight</b> .....                                 | \$29.95 |
| <b>Magazine Extensions</b> .....                                                                                   | \$29.95 | (includes batteries and nylon carrying pouch)                         |         |
| 7 shot for Remington 870, 1100, 11-87 — 8 shot for same<br>guns — 7 shot for Winchester 1200, 1300. All for 12 ga. |         | <b>Universal Barrel Mount #3</b> .....                                | \$19.95 |
| <b>Shell Follower, High Visibility</b> .....                                                                       | \$5.95  | Mounts T-45 flashlight to shotgun as above.                           |         |
| <b>Barrel/Magazine Clamps</b> .....                                                                                | \$5.95  | <b>Tactical Shotgun Case</b> (Fits 18 - 20" with pistol grip) \$29.95 |         |
| 2 different models fit all above guns. Specify shotgun.                                                            |         |                                                                       |         |
| <b>QD Swivel</b> — fits above clamps.....                                                                          | \$4.95  |                                                                       |         |
| <b>Universal Barrel Shroud</b> .....                                                                               | \$15.95 |                                                                       |         |
| 13 3/4 in. long. Fits most 12 ga shotguns without vent rib.                                                        |         |                                                                       |         |
| <b>SideSaddle® Shotshell Carrier</b> .....                                                                         | \$24.95 |                                                                       |         |
| Models to fit Remington 870, 1100, 11-87; Mossberg 500,<br>600; Winchester 1200, 1300; HK Super 90. Specify gun.   |         |                                                                       |         |
| <b>Tactical Sling</b> .....                                                                                        | \$16.95 |                                                                       |         |
| <b>1" Plain Carrying Sling</b> .....                                                                               | \$2.95  |                                                                       |         |

### Moore Technical Industries

P.O. Box 86 - Dept SOF

Bowling Green, MO 63334

We stock the entire TacStar® line of laser sights, flashlights, shotgun accessories. We also carry shotgun accessories by Scattergun Technologies® plus much more. Send \$2.00 for our complete catalog. Refunded on first order. Free with order. **FAX (314) 669 - 5684**  
Add \$5.00 for UPS shipping. We accept MO, Visa, MC, or Cash Only COD. **No checks**, please. We ship only to the United States. Tactical Equipment for Prepared Americans

# SOF 20th Anniversary GREAT GUNS GIVEAWAY!

ENTER SWEEPSTAKES FOR YOUR CHANCE  
TO WIN THIS ASTRA A75 9MM —

For police or civilian use, the A-75 is the most dynamic little super-compact in the world. Durable, safe and easy to use. Includes an exclusive lifetime warranty.



PLUS, SIGN UP NOW AND SAVE BIG —  
12 ISSUES ONLY \$26.20 A  
HUGE 45% SAVINGS\*



Watch  
For Your  
Chance  
To Win  
A New  
Firearm  
Each  
Month  
During  
1995, As  
SOLDIER OF  
FORTUNE  
Celebrates  
20 YEARS!

## YES, HERE'S MY ENTRY SIGN ME UP!

- Enter my name, send me a 1-yr. sub. for \$26.20  
 Enter my name, send me a 2-yr. sub. for \$50.00  
 Enter my name in the sweepstakes only.  
 Credit card orders may call 1-800-877-5207  
 Bill me.

MasterCard  Visa Exp. Date \_\_\_\_\_

Card # \_\_\_\_\_

Signature \_\_\_\_\_

Name \_\_\_\_\_

Address \_\_\_\_\_

City \_\_\_\_\_ State \_\_\_\_\_

Zip \_\_\_\_\_

Day Phone ( ) \_\_\_\_\_

Canada add \$10.00 per year (includes GST #R128476249).

Foreign add \$21.00 per year

POSTMARKED DEADLINE: March 29, 1995

SWEEPSTAKES DRAWING: April 1, 1995

MONEY BACK GUARANTEE

A20195

\* Based on newsstand price of \$3.95. No purchase necessary to win

Fill out the entry card (or coupon) and send to SOF, P.O. Box 348, Mt. Morris, IL 61054-0348 via U.S. mail with entry postmarked no later than 28 March 1995. No entries will be accepted after this date. Winners will be selected by random drawing on 1 April, 1995, and will be notified by mail or telephone. No purchase necessary to enter. All prize winners must comply with Federal, State and local firearms regulations, where applicable. Judges' decisions are final. Sweepstakes open to residents of the U.S. 21 years of age or older. Prize non-transferable. Odds of winning are dependent upon total number of entries. Winners will be printed in a future issue of Soldier of Fortune.

• For name of prize winner, send SASE to Jan '95 Sweepstakes Winners List, c/o SOF Magazine, P.O. Box 693, Boulder, CO 80306

# ADVERTISERS INDEX

|                                            |         |
|--------------------------------------------|---------|
| Adco .....                                 | Cover 4 |
| Amazing Concepts .....                     | 68      |
| Automatic Knife Resource Guide .....       | 68      |
| B-Square .....                             | 63      |
| Benchmade Knife Company .....              | 28      |
| Blackhawk Industries .....                 | 23      |
| Bud K Worldwide .....                      | 29      |
| Cause Foundation .....                     | 64      |
| Collector's Armoury .....                  | 69      |
| Cor-Bon Bullet Company .....               | 68      |
| Criminal Intelligence Administration ..... | 15      |
| Crown Specialty .....                      | 30      |
| Delta Press .....                          | 59      |
| Doubleday Military Book Club .....         | 10-11   |
| Dutchguard .....                           | 13      |
| Excalibur Enterprises .....                | 61      |
| Facets Advertising .....                   | 60      |
| Golden West Ent. ....                      | 69      |
| Gun Gear .....                             | 9       |
| High Caliber .....                         | 70      |
| Intelligence Incorporated .....            | 25      |
| JTR Labs .....                             | 15      |
| London Bridge Trading Co. ....             | 59      |
| Michigan Body Armor .....                  | 67      |
| Moore Technical Industries .....           | 65      |
| National ID Center .....                   | 62      |
| Olympic Arms .....                         | 58      |
| Optimum Training Systems .....             | 19-22   |
| Paladin Press .....                        | 7       |
| Professional Career Development .....      | 67      |
| Quality Machining Inc. ....                | 58      |
| Shotgun News .....                         | 26      |
| Siber Optics .....                         | 63      |
| Small Arms World Report .....              | 70      |
| Southern Ordnance .....                    | Cover 3 |
| S.T.A.N.O. ....                            | 24      |
| Steve Arnold's Gunroom .....               | 76      |
| U.S. Cavalry .....                         | 63      |
| U.S. General Technology .....              | Cover 2 |
| Universal Force Dynamics .....             | 62      |

## SUPPLY LOCKER

|                                       |        |
|---------------------------------------|--------|
| Advice/Security Call .....            | 74     |
| Alpha Publications .....              | 74     |
| American Eagle Publications .....     | 72     |
| C.H. Worldwide .....                  | 71     |
| Carl Ax .....                         | 73     |
| Cutlery Shoppe .....                  | 75     |
| Cutting Edge Enterprise .....         | 71     |
| David Steele Ent Inc. ....            | 74     |
| Eden Press .....                      | 71     |
| Facets Advertising .....              | 75     |
| First Witness Video .....             | 72     |
| Global School Of Investigation .....  | 71     |
| Greene Military .....                 | 74     |
| Gun Parts Corporation .....           | 74     |
| Hawk Laboratories Inc. ....           | 72     |
| Hitek .....                           | 74     |
| Hurricane International .....         | 74     |
| JTR Labs .....                        | 73     |
| LA Law Enforcers .....                | 72     |
| M.O.R.O. International .....          | 75     |
| Matthews Police Supply .....          | 72     |
| Miniature Machine Corp. ....          | 73     |
| National ID Center .....              | 71, 73 |
| Politically Incorrect Graphics .....  | 73     |
| Professional Career Development ..... | 73, 75 |
| Ringer .....                          | 75     |
| Russia Direct .....                   | 72     |
| S & K Products .....                  | 71, 75 |
| Trade Partners Group .....            | 73     |
| USI Corporation .....                 | 71     |
| Westbury Sales Co. ....               | 75     |
| WW2 Products .....                    | 72     |

**ADVERTISING POLICY:** Publication of any advertisement in Soldier Of Fortune Magazine is not an endorsement of the advertiser of the product(s) or service(s) advertised, either by SOF Magazine or by the Editor and Publisher.

making his efforts known to the American Embassy to show his willingness to provide any and all information he possessed with USG officials and to keep these weapons from falling into the hands of unfriendly countries, drug cartels or terrorists."

Downie told SOF that this was a ruse. After Muir, James and Ivey were unable to obtain U.S. government blessing for a legal weapons deal, Downie pointed out, they kept pushing the deal anyway. "I specifically mentioned Libya as a customer and they didn't bat an eyelash," the U.S. Customs undercover operative said, "I did that to establish they had no qualms whatsoever about who would get these weapons."

The State Department cable explained that Muir and James were again told what "had earlier" been explained to them "concerning prohibition of trading and Vietnam under the 'Trading With The Enemy Act.' We explained the penalties that could be imposed under the act and both James and Muir stated that they understood the provisions of the act. Mr. Muir further indicated that he had received a letter from the USG through Mr. Boyce, political counsel, at the embassy in Bangkok."

Yet, after all was said and done and they were unable to obtain permission to broker the millions of dollars in weaponry for the communist government of Vietnam, Muir continued his efforts, apparently unconcerned about any possible penalties, or that the federal government knew in detail of his activities.

Indeed, bear in mind what he told Downie in the phone call of 19 March 1990, after embassy personnel had issued specific, stern warnings against continuing in his efforts to get weaponry out of Vietnam: "I said, OK. Fuck you, too." And that "I wrote a letter to the State Department and told them that I would take such matters as necessary into my own hands in order to move this materiel."

Such bravado and contempt indicate that certainly Muir, and probably James, too, knew something that no one else did: that somewhere, with someone, they had an inside track that made them immune to punishment for their brazen greediness to move ship loads of war hardware for the Vietnamese government.

# BODY ARMOR THAT STOPS .44 MAGNUMS

and weighs only 3 lbs.!



SOFT, COMFORTABLE, CONCEALABLE BODY ARMOR MADE WITH 18 LAYERS OF DUPONT KEVLAR.

**MED: \$170 LRG: \$205 XL: \$275 XXL: \$315**  
Adjustable ballistic panel carriers available in white and navy.

**5 YEAR WARRANTY ON BALLISTICS**  
Prepaid orders add \$5. \$10 charge for COD's. One week shipping for stock sizes. State height and weight when ordering. Money orders and certified accepted. COD's cash only. Air Shipping Extra.

**MICHIGAN BODY ARMOR**  
P.O. BOX 251423, WEST BLOOMFIELD, MI 48325  
TEL/FAX 810-788-2234

# Become a gun repair expert!

PROFESSIONAL-LEVEL HOME STUDY

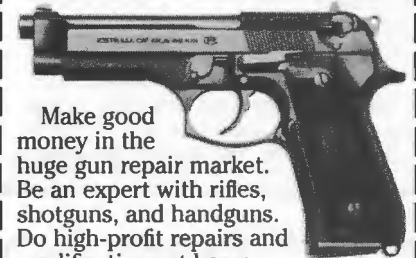

Make good money in the huge gun repair market. Be an expert with rifles, shotguns, and handguns. Do high-profit repairs and modifications at home, qualify for great jobs, too. No costly machinery or fancy workshop needed.

**Free career booklet: call 800-223-4542**

Name \_\_\_\_\_ Age \_\_\_\_\_

Address \_\_\_\_\_ Phone (\_\_\_\_) \_\_\_\_\_

City \_\_\_\_\_ State \_\_\_\_\_ Zip \_\_\_\_\_

**School of Gunsmithing**

6065 Roswell Road  
Dept. GGA171, Atlanta, Georgia 30328

## SWITCHBLADE - AUTOMATIC KNIFE COLLECTORS



### The Automatic Knife Resource Guide and Newsletter

A unique publication for the automatic knife enthusiast, now in its FOURTH YEAR! Terrific photos, in-depth articles, maintenance and repair tips, the LATEST trends, resources for ALL kinds of automatic knives, free classified ads and much, MUCH, MORE! Send \$10. for single issue or \$30. [\$36. Foreign] for a one year (4 issue) subscription to: THE NEWSLETTER, 2269 Chestnut Street, Suite 212-A, San Francisco, CA 94123, USA. Phone/Fax: 415-731-0210.

## TACTICAL ELECTRONICS

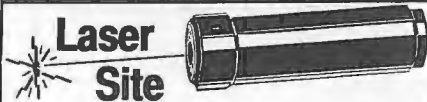

For pistol, rifle, only 2-7/8" x 3/4"  
LATR1 Sub Mini Laser Site ..... \$174.50

100,000 Volt STUN GUN  
Mini size, with safety switch, made in USA.  
Check local laws for possession. STUN2 ..... \$59.50

Phone Taping System  
Automatic, ready to use, with extended play recorder. TAP20X \$129.50

1 Mi+ FM Voice Xmitter  
Ultra-sensitive, hi perf kit, XFM300 ..... \$19.50

Also: 1 Mi+ Automatic Phone FM Xmitter Kit - xmits 2 sides of conversation XTL300 \$19.50

FREE With any Order for Products Above:  
Explosive Paint Plans! 2 part mix, labeled dangerous. TRI1 Plans ..... reg. \$5.00

### AMAZING CONCEPTS

• ORDERS: 800-221-1705 • FAX 603-672-5406  
Send Check, Cash, Money Order, COD, MC, Visa to:  
Dept SF, PO Box 719, Amherst, NH 03031

## NOTICE TO CALIFORNIA RESIDENTS

Some firearms advertised in this magazine may or may not be lawful for sale in California.

Those specifically not allowed for sale in California are:

### A. All of the following rifles:

1. Avtomat Kalashnikovs (AK) series
2. UZI and Galil
3. Beretta AR-70 (SC-70)
4. CETME C3
5. Colt AR-15 series and CAR-15 series
6. Daewoo K-1, K-2, Max 1, and Max 2
7. Fabrique Nationale FN/FAL, FN/LAR AND FNC
8. FAMAS MAS223
9. Heckler & Koch HK-91, H-93, HK-94 and PSG-1
10. MAC 10 and MAC11
11. SKS with detachable magazine
12. SIG AMT, SIG 500 Series, and SIG PE-57
13. Springfield Armory BM59 and SAR-48
14. Sterling MK-6 and SAR
15. Steyr AUG
16. Valmet M62, M71S and M78
17. Amalite AR-180 Carbine
18. Bushmaster Assault Rifle (amgun)
19. Calico M-900 Assault Carbine
20. Mandal THE-TAC-1 Carbine
21. Plainfield Machine Company Carbine
22. PJK M-68 Carbine
23. Weaver Am Nighthawk

### B. All of the following pistols:

1. UZI
2. Encom MP-9 and MP-45
3. MAC 10 and MAC 11
4. INTRATEC TEC-9
5. Mitchell Arms Spectre Auto
6. Sterling MK-7
7. Calico M-900

### C. All of the following shotguns:

1. Franchi SPAS 12 and LAW 12
2. Gilbert Equipment Company Striker 12 and SWD Street Sweeper
3. Encom CM-55

SOLDIER OF FORTUNE MAGAZINE

According to the State Department cable of 27 October 1989, when the conversation drifted into discussion of criminal penalties for engaging in business — especially business in weaponry — with our old enemy, Muir and James then “showed a list of names that they had transmitted to ‘a congressman’ that were purported to be MIA ‘dog tags’ they’d received from VNG officials. Throughout two hours of conversation, subjects revolved around the [POW/MIA] information and questions about other weapons and military vehicles. ... Mr. [James] identified the full name of General Nguyen Hun (Huong) as someone with who he had discussed the issue of weapons. Mr. Muir indicated that some weapons (I believe airplanes) had been sold and delivered to New Zealand and Taiwan.”

If Muir and James really wanted to be so open and above-board, it is interesting that the commercial attache closes his cable by noting that “neither Mr. Muir nor Mr. [James] agreed to hold discussions in the embassy, even after I specifically requested them to. ...” The correspondence also acknowledges the tremendous pressure by Muir, James and other business interests to open Vietnam to business. “I have repeatedly been asked to give inquirers a time frame for possible change in U.S. policy toward Vietnam and always replied that policy changes come from Washington. ...”

Apparently Muir and James may have come out of Vietnam just to meet with the commercial attache in Bangkok, because they immediately returned to Ho Chi Minh City, where they continued to do work on business deals for both weaponry and POW/MIA intelligence. According to Muir, who provided an itemized list of names obtained by this means, 124 identifications tags “were purchased secretly in Saigon between October 29 and Nov. 3, 1989,” which is only three days after their meeting in Bangkok. “Each [ID plate] is a single tag only, about half with chain.”

Within a week, James was headed back to Washington, where he visited Capitol Hill, “spending” some of the dog-tags. A 30 November letter from the congressman who was their contact conveys to James a “thank you for bringing the 85 sets of dog tags to

## It's time to call in the heavy hitters!

Forget those “magic” bullets that turn into pretty stars or grow claws. Cor-Bon® offers street-proven performance, harder-hitting, higher velocities, and low muzzle flash that won't make you the target... all in the heavier bullet weights that the pros prefer: 230 gr. / .45, 180 gr. / .40, 158 gr. / .38, 147 gr. / 9mm and more. Cor-Bon ammo isn't fancy. It just plain gets the job done!

TO ORDER: 1 800 788-2666



# PILLOW PAL

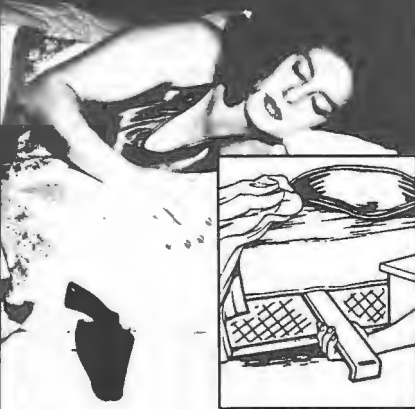

Pillow Pal is a holster holder designed to fit securely between mattress and box spring, or cushion of sofa. Can holster a gun, mace, pepper-spray, stun gun. Allowing ready access to your weapon without leaving your bed. Giving you a chance over your attacker

**\$10.95**

(add \$2.50 shipping, CA residents add 7.25% sales tax)

**Golden West Enterprises**  
Post Office Box 1390, Magalia, CA 95954  
Distributors welcome, Call 916) 877-2431

Caution: firearms to be kept out of the reach of children

# COLLECTORS RUSSIAN EDITION OF SOLDIER OF FORTUNE

\* Each issue is numbered and includes a notarized statement of authenticity.

**Limited  
Number  
Available**

\* Each certificate is signed by Robert K. Brown.

\* Less than 600 available!

\* Only \$20 per copy!

Payment enclosed (U.S. funds only)

MC  Visa Exp. Date \_\_\_\_\_

Card # \_\_\_\_\_

Signature \_\_\_\_\_

Name \_\_\_\_\_

Address \_\_\_\_\_

City \_\_\_\_\_

State \_\_\_\_\_ Zip \_\_\_\_\_

mail to: **SOF Russian Edition**

**P.O. Box 693 Boulder CO 80306**

my office. ... The Defense Intelligence Agency now has custody of the tags. I am sure that they will do everything necessary to investigate both their origin and the fate of their former owners."

[Investigation revealed that all names were of military personnel who were killed in action or who had been otherwise accounted for, *SOF* was told. *SOF* obtained a copy of the list of 124 names, which Muir had signed and telefaxed from his company office in Hong Kong.]

More ID tags, some flight suits and a West Point ring were brought out of Vietnam by Muir and James. As the Vietnamese government began to apply more and more pressure to do a deal or get out, Downie placed a tentative order for LAW rockets, TOW missiles, 60mm mortars, M16s, M14s, M79s, Mk 19 40mm grenade launchers, M79 grenade launchers and GE mini-guns. Muir revealed that he had 16 ships at his disposal to move the merchandise.

As a deal seemed imminent, Downie said he was able to identify the British attorney living in Hong Kong (Angus J. Forsyth), the bank (Standard Charter Bank of Singapore, Ltd.) and the banker (Jonny Wei) who were being pulled together to close the transaction. James introduced him to two more players from James' home state who said "they had just completed a \$2 million arson scheme," and that "this money would be used to finance their portion of the arms transaction."

As negotiations went into high gear, Muir and James set up code-words by which to communicate via telefax the evolving deal. James was dubbed "Big J," Joe Ivey as "Little J." Muir was "Bear," Percival was "Spider," Downie "the Chief Mountie." The British lawyer in Hong Kong became "Eagle," Vietnam the "Land of Oz." To increase confusion between deals over POW/MIA intelligence and weaponry, the munition warehouses became "zoos," the weapons themselves labeled as "animals." The chief Vietnamese negotiator, a general, became "Zoo Keeper," his ultimate boss in the defense ministry the "Wizard of Oz."

"Eagle, who is very experienced in the handling of these species of animals, is ready," said one such communique obtained by *SOF*. "Once we

# COUNTERFEIT GUNS

that are inexpensive to own and safe to display in your home. They are realistic, full size working metal models that look, feel, weigh and handle like the expensive originals. You can work the action, release the clip and dry fire these high quality models.

**CANNOT BE FIRED!**



## ISRAELI UZI SUBMACHINE GUN

Used by Israeli troops in the historic 6-Day War, the Entebbe Raid. Adopted 30 other nations as the most successful sub-machine gun on the market today.

Over 72 parts folding metal stock detachable 32-round magazine. Length 25" Wt. 9 lbs.

#01-705M.....\$310 PPD

**Exact Replicas in Metal!...**



## 1921 THOMPSON

as used by FBI & U.S. combat troops. Over 59 parts, including vertical foregrip, detachable wood butt-stock & 20-rd. magazine. Lgh. 35". Wt. 9.5 lbs. **Disassembles like original.**

#01-700 .....\$299 PPD

**Full size (non-firing) models look, weigh, and handle like the originals.**

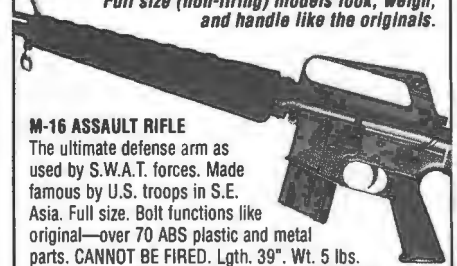

## M-16 ASSAULT RIFLE

The ultimate defense arm as used by S.W.A.T. forces. Made famous by U.S. troops in S.E. Asia. Full size. Bolt functions like original—over 70 ABS plastic and metal parts. **CANNOT BE FIRED.** Lgh. 39". Wt. 5 lbs.

Declared "non-gun" by the Federal Gov't. #39-2707.....\$300 PPD

**FULLY ASSEMBLED**

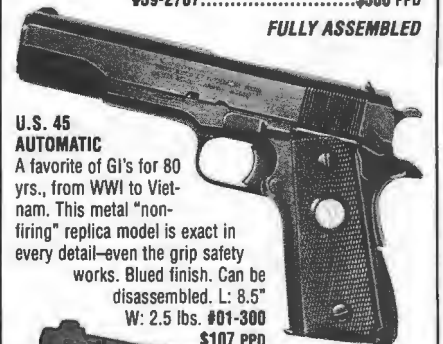

## U.S. 45 AUTOMATIC

A favorite of GI's for 80 yrs., from WWI to Vietnam. This metal "non-firing" replica model is exact in every detail—even the grip safety works. Blued finish. Can be disassembled. L: 8.5" W: 2.5 lbs. #01-300

\$107 PPD



## M92 AUTOMATIC

This massive 9mm was chosen to replace the .45 auto. Made famous in Operation Desert Storm, this blued "non-firing" metal model actionworks like the original. Can be partially disassembled. L: 8.5" W: 3 lbs. #22-1254.....\$102 PPD

## COLLECTOR'S ARMOURY

800 SLATERS LANE, DEPT. SO  
BOX 59, ALEXANDRIA, VA 22313

Not sold to Calif. except for theatrical use.

SEND: \_\_\_\_\_  SEND FREE CATALOG  
Credit Card Orders: 1-800-544-3456 Ext. 515

NAME \_\_\_\_\_

ADDRESS \_\_\_\_\_

CITY/STATE/ZIP \_\_\_\_\_

**MONEY BACK (LESS POSTAGE) IF NOT SATISFIED**

# HIGH CALIBER 1995

## Women & Weaponry Calendar

All  
New



Full  
Color

Send check or money order for \$14.95 for each Calendar ordered plus \$3.00 shipping and handling for 1st calendar \$1.00 for each additional one to:.

High Caliber  
925 W. Baseline Rd. • Suite 105-K26  
Tempe, Arizona 85283-1100 USA

  
Visa/MC  
Customer Welcome  
Include Exp. Date

1-800-846-4237  
Worldwide  
High Caliber® 1994

  
Over Seas  
Customers add \$5  
extra for shipping

### THE LEVEL OF INTENSITY ON THE BATTLEFIELD ALWAYS DEPENDS ON YOUR PERSPECTIVE

Get a new perspective on the world of small arms  
with **SMALL ARMS WORLD REPORT** - the journal from  
the **INSTITUTE FOR RESEARCH ON SMALL ARMS**  
IN INTERNATIONAL SECURITY

Write for more information or send \$2 (postage) for  
a sample copy of **SMALL ARMS WORLD REPORT** to:  
IRSAIS, Dept. A, 424 S. Washington Street, Alexandria, VA 22314

Phone (703) 549-7353 FAX (703) 549-7354

convince the zoo keeper that this deal will continue on ... we think the wizard will concur and give his necessary blessings. For Spider and Little J to set this up, plus inspect the animals to insure that they are alive and well enough for shipment, we expect a couple of weeks, at least. ..."

Suddenly, Downie said, as it appeared everything was about to fall into place and U.S. Customs was about to catch the perpetrators red-handed in an illegal \$70 million deal, things seemed to go haywire in the upper echelons of U.S. Customs and Treasury Department. When the State Department learned that Downie was dealing directly with Muir, they suddenly became quite interested and advised Downie to lure him to a meeting in Hawaii, "or anywhere in U.S. territorial waters," Downie said. "They wanted to snatch the guy bad."

Arrangements were made, then Muir suddenly "got suspicious for some reason and wouldn't go any further than Hong Kong," Downie said. "Customs suddenly instructed me to slow everything down as much as possible."

Downie did, and to his utter astonishment, he was "advised that the Vietnamese General Nahm [Zoo Keeper] was killed for moving too slowly on the deal." Downie said his U.S. Customs senior agents monitoring Operation Leatherneck expressed total disbelief when this intelligence was passed up the chain of command. Within a week, however, Nahm's execution was confirmed by CIA and the State Department.

*During the past two years James L. Pate has specialized in uncovering and documenting corruption by federal law enforcement agencies.*

*In next month's conclusion of the three-part series on Mickey Downie, learn how senior officials in U.S. Customs and the Treasury Department's Office of Foreign Assets Control sabotaged Operation Leatherneck and launched an ongoing campaign to destroy the careers of honest agents who'd worked with Downie — a life-threatening vendetta that continued to hunt and haunt Downie on undercover assignments from Ohio to Tennessee. ✕*

**COVERT ACTION TANTO ONLY**  
**\$19.95**  
 +\$3.00 SHPG.



Black silent and rugged, this knife will get the job done. Features a 6" blade, sure-grip Zytel® design, "skull crushing" pommel, and incredible penetrating power. 30 day money back guarantee!

Send check or M.O. to: **Cutlery Connections\*2101 W. Broadway #171-Columbia, MO 65205-6018**

**AUTOMATIC KNIVES**

**Only \$29.95 each!**  
 +\$5.00 shipping and handling

Protection at the touch of a button! Lightning fast, stainless steel blade and shock resistant handle.

Save \$10 on orders for 2 or more! 24 hr. order turnaround and best price guaranteed (slight delay on personal checks). Don't delay, order now! C.O.D. orders call toll-free anytime. Send check or M.O. + \$5 Shipping to:

**Cutting Edge Ent.**  
 2101 W. Broadway #171  
 Columbia, MO 65205-6018  
**1-800-554-5880**

**30 DAY MONEY BACK GUARANTEE!**



**.22 L.R. AMMO FOR SILENCED WEAPONS Subsonic Hollowpoint Ammo**

No Muzzle Crack! Less Noise for any .22! Loads flawlessly in all guns! Manufactured in Germany. Used by Israeli Mossad and numerous Elite Paramilitary Forces! Quietest .22 L.R. Ammo in the world! Matchgrade Accuracy! No License Required to Buy! UPS delivery only/No PO Boxes! Order now!

**Box of 50, \$6.95; + 3.50 S&H**  
**3 Boxes for \$18.95; + 5.00 S&H**

Name \_\_\_\_\_  
 Address \_\_\_\_\_  
 City/St/Zip \_\_\_\_\_  
 Card # \_\_\_\_\_ Exp. \_\_\_\_\_  
 Visa  M/C  M/O  Check  Free Catalog with order!

**NIC Law Enforcement Supply**  
 500 Flournoy Lucas-PO Box 5950-F22  
 Shreveport, LA 71135  
 24-Hour #318-688-1365 FAX #318-688-1367

**Laser Shot™ 2000**



- FREE MOUNT • FREE HOLSTER
- FREE BATTERY • FREE SHIPPING
- FREE CALL • 1 YEAR WARRANTY

**\$89\***  
 \*DON'T PAY '99

Dealer Inquiries Welcome

**C.H. WORLDWIDE**  
 P.O. Box 2712 • San Ramon, CA 94583  
 Tel 800-291-5511 • Fax 510-838-3172



**Be a DETECTIVE AND EARN YOUR BADGE**  
 SPECIAL SOF PRICES! NO EXPERIENCE NEEDED

**MEN - WOMEN**  
 TRAIN AT HOME FOR AN EXCITING PART OR FULL-TIME CAREER AS A PRIVATE DETECTIVE. START YOUR OWN AGENCY OR WORK FOR OTHERS. LEARN ALL THE LATEST TECHNIQUES FROM THE EXPERTS.

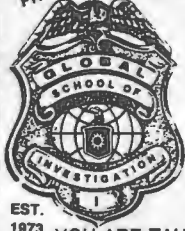

**YOU ARE TAUGHT BY FORMER MILITARY INTELLIGENCE SPECIALISTS, POLICE AND PRIVATE DETECTIVES. "THE ONLY COURSE OF ITS KIND." YOUR PAST EXPERIENCE COMBINED WITH THE UNIQUE GLOBAL PROGRAM WILL MAKE YOU A PRIVATE DETECTIVE.**

**CALL NOW 617-721-4292**  
 NO OBLIGATION • NO SALESMAN

**GLOBAL SCHOOL OF INVESTIGATION**  
 171 S. PARK ST. STONEHAM, MA 02180

NAME \_\_\_\_\_  
 ADDRESS \_\_\_\_\_  
 CITY \_\_\_\_\_ STATE \_\_\_\_\_ ZIP \_\_\_\_\_

**FREE INFORMATION**



"Now earning \$100,000 a year as a P.I. Thank you Global."  
 A.R. Texas

*Don't get fooled by Frauds*  
**100% GUARANTEED**  
*Anabolic Muscle Building*

**STEROIDS Replacement**

This product is to be taken orally. No harmful side effects.

**S&K Performance Product Boron!**  
 Can dramatically increase your **Testosterone levels up to 300%!**



Higher Testosterone means faster, easier muscle growth! Greatly enhance your physical appearance literally sculpting your own body with huge healthy, hard muscle.

Get that lean awesome body builder physique now with one 3 month cycle for only **\$15.95!**

If you are not completely satisfied with the growth you obtain within 15 days return it for a full refund.

**Money back guarantee!** To get your super anabolic growth cycle from:

**S&K Performance Products**

Order Now!!!  
**\$15.95+shipping**    
**1-800-398-6946**  
 24hrs. 7 days a week  
 C.O.D.'s welcome add \$4.00 shipping.  
 Check or money order send with **\$15.95+shipping and handling to:**  
**S & K Labs, 2637 E. Atlantic Blvd. Suite 101, Pompano Beach, FL 33062**

**THE HOUND DOG**

**Sniffs Out Hidden Transmitters**

Throughout the world today, corporations, professional men, and businessmen are spending millions annually to insure privacy in their offices and homes where important plans and policy making decisions are discussed and formulated. The "HOUND DOG" is a wise investment for anyone who has reason to believe that an eavesdropping device is now hidden, or may be hidden in the future, in either home or office. No radio transmitter, no matter how well it may have been hidden, can escape detection by the "HOUND DOG".

The "HOUND DOG" is an advanced electronic instrument designed for the sole purpose of locating hidden transmitters. An average size office or room can be thoroughly searched in only a matter of minutes. The "HOUND DOG" sniffs out any transmitters hidden in pictures, walls, desks, chairs, etc., regardless of their operating frequency.

The "HOUND DOG" is simple to use. Single knob adjustment calibrates the meter and any transmitter signal received is indicated by the meter movement. By simply sweeping the probe past walls, chairs, pictures, desks, etc. the presence of any transmitter will cause a rise in the meter reading. The meter reading will continue to rise as the probe approaches the transmitter.

We believe you will find the "HOUND DOG" outperforms most other units selling for several times the price. This item has been built since 1962. Each one is backed by a 3-year warranty by us.



Meter Calibrate  
 Probe extends to 16 inches

SIZE . . . 1.5 x 2.4 x 8.2 INCHES **\$195.00**  
**USES A COMMON RADIO BATTERY**

**Super Powerful FM TRANSMITTER**

Many times more powerful than other transmitters. Transmits up to 1/4 mile to any FM radio — Easy to Assemble Kit — up to 9V battery (not incl.)

**\$19.95**

Call 407-725-1000 or send \$195.00 plus \$5.00 shipping for Hound Dog and \$19.95 and \$1.00 shipping for FM Transmitter to USI Corp. P.O. Box 8F-2052, Melbourne, FL 32902. COD's OK. For a catalog of transmitters, voice scramblers & other specialty items enclose \$2.00 to USI Corp.

**PRIVACY ?**

**Avoid BIG BROTHER.**  
**Best techniques for creating COMPLETE PRIVACY!**

- Avoid Surveillance, Eavesdropping
- Become "Invisible" to Investigators
- Stop Generating Financial Records
- Communications Privacy . . . Phone, Mail
- How to Stay Out of Government Files
- Begin Eliminating Negative Records
- How to Create Helpful New Records
- Generating Quick Cash Income
- Hiding Your Assets ■ Privacy Afloat
- Banking Alternatives ■ "Low Profile"
- Privacy from Taxes ■ Nomadic Living
- Multiple Addresses
- Hideouts, Deep Cover
- How to "Disappear"

**ALL THE PRIVACY YOU WANT — and MORE!**  
 Visa/MC: 800-338-8484  
**ONLY \$18.95**



**EDEN PRESS**  
 11623 Slater "C", Box 8410-AP Fountain Valley, CA 92728

Your  Regular P&H, \$3.00 (Please add Choice  FIRST CLASS, \$6.00 to order.)  
 (California residents please add 7.75% sales tax.)  
 Send latest Book Catalog — FREE.

Name \_\_\_\_\_  
 Address \_\_\_\_\_  
 City \_\_\_\_\_  
 State \_\_\_\_\_ Zip \_\_\_\_\_



# Set Your Sights On Santa!

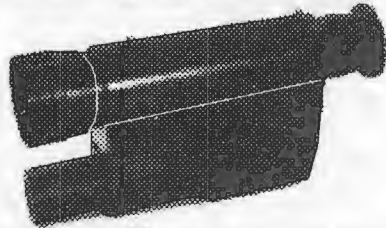

**Rifle Mountable Night Vision Scope!**  
See Santa before he can slide down the chimney with this very affordable night vision scope! It is dovetailed, rifle mountable, camera adaptable, and can be fitted with an infrared illuminator for those very dark Christmas nights! Excellent for night time critters. New! **\$199.00**

Russia Direct Inc.  
Tel : (212) 219-8171  
Fax: (212) 219-8953

106 Franklin St. NY, NY 10013

**NIGHT VISION!**

## COMPUTER VIRUSES

Trojan Horses  
Logic Bombs

Information Warfare  
Electronic Death

**The Collection: Outlaws from America's Wild West** is the most dangerous CD-ROM on this planet! This IBM compatible disk contains over 5000 live computer viruses, virus creation toolkits, trojan horses, mutation engines, and all the source code and information you need to create your own. **WARNING: This CD is illegal in some countries and may soon be illegal in the US. Get it while you can!**

**\$99.95 + 7.00 Registered shipping**

ORDER TODAY or call or write for our **FREE** catalog of interesting books and computer disks on computer viruses, cryptography and info warfare!

**American Eagle Publications**  
P.O. Box 41401-S  
Tucson, AZ 85717

1-800-719-4957 (Visa/MC/COD)

## HAWK

JACKETED HUNTING BULLETS

"... truly amazing bullets ..."

- C. Greenwood, Guns Review, U.K.
- Unsurpassed accuracy.
- Controlled expansion.
- Superior penetration.
- High weight control.
- More one shot kills.



Obsoletes, African, European and Single Shot Pistol calibers.

From .264 to .577 cal.

For more info. and prices send a SASE to:  
Hawk, Inc., P.O. Box 1689, Dept. SOF 01  
Glenrock, WY 82637 (307) 436-5561

## LEGIONNAIRES SURVIVAL BOOT KNIFE

ONLY \$12.95

Add \$1.05 Hndl.



Model K-90-A

Double edge 440 stainless steel blade. Full tang one piece construction. Leather sheath with quick release snap and metal boot/belt clip. **Money Back Guaranteed If Not Fully Satisfied!**

WESTBURY SALES CO. DEPT BK-01-SF  
156 Post Avenue, Westbury, New York 11590

# CAPITALIZE ON CRIME

IT CAN PAY

**HUGE PROFITS!**  
CRIME PREVENTION IS A MULTI-MILLION DOLLAR BUSINESS!  
OUR DEVICES SELL LIKE CRAZY

FREE WHOLESALE CATALOG

We carry the best line of security sprays, stun guns, personal sound alarms, burglar alarms and much more. We specialize in offering the best security products at the very best wholesale prices.

|                                  |                                  |
|----------------------------------|----------------------------------|
| 10% Pepper Sprays                | Personal Sound Alarm             |
| Key Chain Sprayer                | 4 oz. Fogger                     |
| Retail \$19.95<br>Sample \$7.95  | Retail \$22.95<br>Sample \$10.95 |
| Retail \$34.95<br>Sample \$10.95 |                                  |

|                                  |                                   |
|----------------------------------|-----------------------------------|
| Electronic Stun Guns             | Security Plus-Maxo                |
| 100,000 Volt                     | 200,000 Volt                      |
| Retail \$69.95<br>Sample \$29.95 | Retail \$119.95<br>Sample \$39.95 |

**CALL OR WRITE TODAY!**

We are committed to your success. Crime does not wait! Will you?

**L.A. LAW ENFORCERS**  
1005 N. 1st Street., Dept SW  
Yakima, WA 98901  
(800) 967-8133 • FAX (509) 575-1875



**Night Vision Rifle Scope!**  
Baigish 5P. 2nd Generation Scope, lighted center aiming mark.  
Only \$995.00

Also offering a full line of Night Vision Binoculars and Scopes  
For as low as \$195.00

Factory New, Military Style Night Vision equipment can now be yours!! Great for Home Security, Surveillance work, boating and wildlife observation. One-year warranty and the lowest prices anywhere!!

We also offer a full line of hidden Video Equipment



World's Smallest Video Camera  
See's through a 1/32 inch hole.  
Only \$295.00

Undercover Radio Video Camera  
Video Anyone Anywhere  
Only \$375.00

First Witness Video Surveillance Systems  
300 North Central Ave., Staunton, VA 24401  
Call 1-800-880-1521

Tel: (703) 886-1521 Fax: (703) 885-2342  
Visa MC



## BULLETPROOF VEST

Will stop the .357 Magnum, 9mm and 00 Buck. Meets and exceeds "Threat Level II-A" tested in accordance with the NILECJ-STD-0101.01. Weighs 2 3/4 lbs. Fits easily under T-shirt.



Front & Back Protector \$220  
Detachable Side Panels \$45  
Chest Trauma Plate \$35

Officially tested by the U.S. Government Edgewood Arsenal at the Aberdeen Proving Grounds under the U.S. Department of Justice Standards. State height, chest and waist measurements.

**MATTHEWS POLICE SUPPLY CO.**

(a division of David Matthews, Inc.)  
P.O. Box 1754 Dept. SF  
Matthews, N.C. 28105  
Ph. (704) 847-8793 FAX: (704) 847-4447

MMC UNIVERSAL FN FAL/LAR SCOPE MOUNT  
Fits all models including Paratrooper.



**59.95**

Plus \$4.00 Ship/Hand  
TX Res. Add \$4.65 Tax

MMC UNIVERSAL AK SCOPE MOUNT  
Fits all AK (KALASHNIKOV) type firearms.



**39.95**

Plus \$4.00 Ship/Hand  
TX Res. Add \$3.10 Tax

Both mounts are lightweight, ultra low profile & rigid. Unobstructed view of iron sights over mount. Field stripping capabilities retained with scope and mount in place.



MINIATURE MACHINE CORP.  
606 Grace Ave. / Dept. SOF  
Ft. Worth, TX 76111 / (817) 831-0837

CAREER-LEVEL HOME STUDY COURSE:

# Be a paralegal!

With the right training, you could join this exciting, fast-growing career. Prepare now for a great future working closely with attorneys. Call or send 24 hours a day for your free career literature.



**800-223-4542**

Name \_\_\_\_\_ Age \_\_\_\_\_  
Address \_\_\_\_\_ Phone (\_\_\_\_) \_\_\_\_\_  
City \_\_\_\_\_ State \_\_\_\_\_ Zip \_\_\_\_\_

School of Paralegal Studies, Dept. LLA171  
PCDI, 6065 Roswell Rd. Atlanta, Georgia 30328

**T-SHIRTS**

Man's Best Friend  
cat#001 -> <- cat#008

**FLUSH**  
RAP <- cat#005  
DOWN THE TRAP  
 I DON'T GET MAD  
cat#010 -> I GOT 'EM

Black T's - full color designs  
M-XL \$15/XXL \$17/USA & \$3 S&H, \$1 ea add'l  
Call. residents add 8 1/4% tax  
Foreign/\$8 S&H, \$3 ea add'l  
Catalog - \$1 & 29c stamp  
Send - ck or mo to:  
PIG (Politically Incorrect Graphics)  
P.O. Box 2147AS, Orinda, CA 94563  
Credit Card orders call (510) 531-5028

# STEROIDS

## D-BALL TEST JET DECA

Anabolic Steroids increase Testosterone levels to Build Muscle Mass and Strength

Now there is a safe and effective replacement for steroids. **Boron\***. Tens of thousands have used **Boron** from JTR Labs to successfully replace steroids without the harmful side effects. *Guaranteed*. Check out these results. All from **Boron** users.

"...20 pounds of muscle in three months..." Willie Beck III. AL  
Terry Goetz. VT. Put 90 pounds on his bench. "...two inches in my chest..." J. Ramsey. TX  
"...its the extra edge I needed..." Charles Walters, Military  
*All these amazing gains using Boron.*

For your own Huge Increases - Order your 3 month cycle of **Boron** today. Only \$19.95, shipping included. Blow away your competition and order now.

\*Boron is a safe, 100% natural nutrient

COD's, Credit Card, Catalog orders call:  
**1-800-962-4769**...ask for dept.#682

Order lines open 24 hours 7 days a week  
Send check or money order to:

**JTR LABS**  
10230 Bach Blvd.  
Dept.#682  
St. Louis, MO 63132

### HOME OF THE LIFETIME GUARANTEE

**WARNING:** Accept no imitations or copy cats. JTR Labs, gives you the highest quality Boron. For 6 years. Unlimited Guarantee.

## After 'Nam: A Police Story

**Howard Dale thought his warring days were over when he left Viet Nam. Then he became a cop...**

Rich in detail and human passion, this is a frank and "street level" story of how one Marine Vietnam vet's war did not stop when he came home; Howard Dale merely changed uniforms from Marine to police officer.

"A book of artistry and great significance. A powerful novel that is long overdue."  
— Chuck Dean, author of Nam Vet: Making Peace With Your Past

Send only \$7.95 — full price— including postage, etc., payable to:

Carl Ax  
P.O. Box 25  
Earlville, PA 19519

# TIGER Sporting KNIFE

*The Ultimate Tool of the Trade*

only **\$24.95** 30-Day Money-Back Guarantee!

Two-Position, Locking Stainless Blade  
Closed-fist Grip for Sure Handling  
Rugged Field Construction

CA Residents add 7.25%

Send Check or Money Order to:  
Trade Partners Group  
P.O. Box 5120-375 • 4195 Chino Hills Pkwy  
Chino Hills, CA 91709

## PHOTO CARD KITS

MONEY BACK GUARANTEE!

Our Professional quality, laminated photo cards will amaze your associates! We provide the cards, plastic laminate and easy instructions! You provide only a photo. Your photo Card can be finished in the privacy of your home! The result is a distinctive, professional system! The highest quality cards in the US! Lost your original card? Replace it now!

**only \$4.95** C203 Bail Enforcement Agent  
Select From These Kits:

|                                                     |                                                   |
|-----------------------------------------------------|---------------------------------------------------|
| C04 <input type="checkbox"/> Bounty Hunter          | C06 <input type="checkbox"/> Mercenary            |
| C13 <input type="checkbox"/> Special Investigator   | C41 <input type="checkbox"/> Intelligence Officer |
| C45 <input type="checkbox"/> MAC-V (CIA), #1        | C212 <input type="checkbox"/> Official Press      |
| C60 <input type="checkbox"/> MAC-V (CIA), #2        | C46 <input type="checkbox"/> Special Forces       |
| C14 <input type="checkbox"/> OCB                    | C47 <input type="checkbox"/> Seal Team            |
| C52 <input type="checkbox"/> Air America Pilot      | C18 <input type="checkbox"/> Pilot                |
| C01 <input type="checkbox"/> Press Card             | C03 <input type="checkbox"/> Security             |
| C50 <input type="checkbox"/> Phoenix Program        | C17 <input type="checkbox"/> Int'l Drivers Permit |
| C49 <input type="checkbox"/> Delta Force            | C11 <input type="checkbox"/> Private Investigator |
| C25 <input type="checkbox"/> Parachutist, Certified | C02 <input type="checkbox"/> Bodyguard            |
| C26 <input type="checkbox"/> SCUBA, Certified       | C12 <input type="checkbox"/> Security Consultant  |
| C07 <input type="checkbox"/> Weapons Specialist     | C51 <input type="checkbox"/> Special Operations   |

Any Three Only **\$11.95** Any Six Only **\$19.95**

**NIC Law Enforcement Supply**  
500 Flourney Lucas Rd. Box 5950-SV  
Shreveport, LA 71135-5950

**COLOR CATALOG \$2.00 OR FREE WITH ORDER**

Name \_\_\_\_\_  
Address \_\_\_\_\_  
City/State/ZIP \_\_\_\_\_

Card # \_\_\_\_\_ Exp. Date \_\_\_\_\_  
VISA  M/C  CHK  MO  24-hour order No. (318) 688-1365  
FAX # (318) 688-1367

# PRIVATE INTELLIGENCE SECRETS

by James L. Drake

Tricks of the trade compiled by over 100 Intelligence agents! Inside information usually only known to detectives.

**INCLUDES HOW TO:**

Detect a Two-Way Mirror, Protect Your Privacy, Find Out Any Person's Bank Balance, Find Missing Persons, Get A Non-traceable Credit Card From Switzerland, Skip-Tracing, Auto Tailing, Spot Lying Gestures, Conduct Surveillance, Read Burned Documents That Have Turned to Ash, Low Profile Living, Stop Paper Trails, Perform Handwriting Analysis, and Much More — **GET AN EYEFUL!** Large 8½ x 11 format, 112 pp., illus., quality softcover. \$16.95 plus \$2.50 P & H. (First-Class Mail \$5.00) Catalog of Off-Beat Books \$1.00. (Catalog Free With Order) Sold for informational purposes only. **Money-Back Guarantee If Not Delighted. ORDER YOUR COPY TODAY!**



**Alpha Publications**

P.O. Box 308-H • Sharon Center, OH 44274

Please send me \_\_\_\_\_ copies of Private Intelligence Secrets at \$16.95 each, plus \$2.50 P & H, 1st Class \$5.00. Ohio Residents add 5½% Sales tax. **Visa/MasterCard Welcome** FAX (216) 239-1392

Name \_\_\_\_\_  
Address \_\_\_\_\_  
City \_\_\_\_\_ State \_\_\_\_\_ Zip \_\_\_\_\_

# GUN PARTS CORPORATION

SUCCESSORS TO NUMRICH ARMS

## THE WORLD'S LARGEST GUN PARTS SUPPLIERS

NEW FOR 1995 #19CATALOG

Featuring an inventory of over 450 million gun parts we have for sale. A 680+ page catalog with exploded drawings that are invaluable to the gunsmith or hobbyist. Commercial, military, antique and foreign gun parts (many exclusively available from us) are listed and priced along with accessories, surplus & specialty items. A veritable encyclopedia of gun parts, this catalog will pay for itself with info and time saved in identifying parts.

U.S. SEND \$7.95 (ALLOW 4-6 WEEKS) FOREIGN SURFACE \$12.00 (IMMEDIATE UPS DELIVERY) FOREIGN AIRMAIL - \$25.00

GUN PARTS CORP. BOX SF0195, W HURLEY, NY 12491  
914-679-2417 FAX 914-679-5849

### FREE!!!

WITH EVERY ORDER FULL COLOR CATALOG & MINIATURE BOOTKNIFE W/KEYRING SHEATH



**THE ULTIMATE COMBAT/SURVIVAL KNIFE!**  
**GIANT 15 1/4" OVERALL**  
10" 420 J2 stainless steel blade. Handle & sheath hold a complete survival kit. Hurry! Limited Supply!

Super Low Price at \$39.95 <sup>MS</sup> <sup>SAH</sup>  
**1-800-385-4103** CREDIT CARDS AND C.O.D.  
OR RUSH CHECK OR MONEY ORDER FOR \$44.95 TO:  
**HURRICANE INTERNATIONAL**  
PO Box 109, Cold Spring Harbor, New York 11724

# BE ALERT! MONITOR FOR PHONE SURVEILLANCE

Millions of phones get tapped each year.  
*Are you next?*  
Protect your Fax, Modem & Voice Communications with the patented\* **SC 1100 Wiretap Alarm System.**  
*It's the only effective automated wiretap alarm system\* available today!*

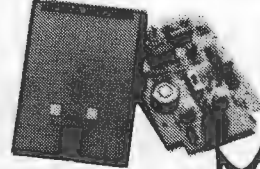

Now Only

\*U.S. Patent# 4,658,099  
\*\*Premise System  
**ORDER TODAY \$139**  
**1-800-334-0074**  
Dept 491  
VISA \* MC \* AMEX (Plus \$7 shipping)  
15425 Los Gatos Blvd Los Gatos, CA 95032-2541

## SECURITY CALL™

# HANDS-FREE NIGHT VISION

EXCLUSIVELY from HiTEK International, these proprietary goggles are manufactured at our own factory and are full of features not available even on much more expensive units. Now offered to you **factory-direct**. Great for use on boats, off-road vehicles or wherever you need both hands free while seeing in the dark!

We offer a full line of low-cost, high-performance Night Vision binoculars, goggles, spotting & rifle scopes.

**NEW UNITS FROM ONLY \$495!** Plus \$12.00 S&H

**30-Day Money-Back Guarantee!**

Call Now: **1-800-54-NIGHT**  
VISA - MC - AMEX - DISCOVER  
Californians add 7.75% sales tax

# HiTEK

490 El Camino Real, Redwood City, CA 94063  
TEL: 415-363-1404 • FAX: 415-363-1408  
Use of these products for hunting & other activities may not be legal in your area

## WE OFFER THE LARGEST SELECTION OF BDU'S OF ANYONE!

Starting at

|         |         |         |
|---------|---------|---------|
| \$25.95 | \$33.95 | \$35.95 |
| XS-XL   | XXL     | XXXL    |

★ ★ ★ ★ ★ ★ ★ ★ ★ ★ ★ ★ ★ ★ ★ ★

**M65 FIELD JACKETS**  
Woodland, Olive Drab, Tiger Stripe, Black, Navy, Khaki. Add \$4.00 for XX ..... **\$59.95**

**PULLOVER PARKA**  
Woodland, Olive Drab, Tiger Stripe, Black, Navy, Khaki. Add \$4.00 for XX ..... **\$44.95**

**ALPHA MA-1**  
Sage or Black or Navy ..... **\$56.95**

**ALPHA CWU-45P**  
Sage or Black ..... **\$78.95**

**COOPER USAF A-2 LEATHER JACKETS**  
36 - 46 Reg. .... **\$242.95**

**G. I. ALICE PACK**  
Olive Med. .... **\$58.95**  
Large ..... **\$62.95**

Prices may vary depending on sizes. Please call for additional prices and items as well as a 1994 Catalog. Mail proper amount plus 6.75 (double for Canada), (TN residents add 8.25% sales tax) for shipping and handling to:

**GREENE MILITARY**  
7215 Kingston Pike, Dept., SF, Knoxville, TN 37919  
Order Toll Free 1-800-521-7977 In TN (615) 588-5945  
Satisfaction Guaranteed or Your Money Back

# THE BODY SCULPTOR

Develop the body you've always dreamed of having. Add inches to your chest, arms, and thighs. Sculpt your stomach, buttocks, and calves. The Body Sculptor builds & tones muscles, and relieves stress and tension. Adjustable electrical impulses work your muscles more effectively than regular exercise. It's medically proven, effortless and safe! Use it at home, in the office, traveling, even while reading or watching T.V. **Results guaranteed in 30 days or your money back!** Less a 15% restock fee

**Your unit includes the following:** • 24 hr. customer service • Free AC wall adapter • Complete instructions • 5 year Iron-Clad warranty • Free Carry Case • 30 day trial period

A. BM-1004, 6-pad model w/AC adapter, \$220  
B. BM-1006, 8-pad model w/AC adapter, \$259  
C. BM-1008, 12-pad model w/AC adapter, \$359  
D. BM-1012, 16-pad model w/AC adapter, \$459  
E. BM-1014, 18-pad model w/AC adapter, \$499

\*Add \$10 for ship & hndlg. \*CA res. add 7.75% tax.  
Call Now For Immediate Delivery!  
1-800-401-4677 (U.S. & Canada)  
or send check money order to: David Steele  
641 Leigh Aisle, Dept. SOI 0195, Irvine CA 92715

These Are The Finest Electronic Muscle Stimulators Available Anywhere!

# STEROIDS

ALTERNATIVES

**ALL PRODUCTS 100% NATURAL  
NO HARMFUL SIDE EFFECTS**

- DIBENCOZIDE 10 mg** is the most powerful steroid replacement on the market & 100% legal. *World records have been set while using this product!*  
**2 month cycle \$22.50**
- BORON 10 mg** can naturally enhance your testosterone level up to 200%. So you can build muscle *without the harmful side effects of illegal steroids.*  
**3 month cycle \$15.95**
- GROWTH HORMONE RELEASER G.H.R.X.** Releases growth hormone in an abundance like no other. *Works great with Boron.*  
**60 tabs \$21.00**
- LEGAL STEROL COMPLEX** enhances growth. Allows body to stay pumped longer. Releases growth hormone and *strips away fat!*  
**60 tabs \$19.95**

**LIFETIME 100% MONEY BACK GUARANTEE**

Buy Products 1, 2 & 3 and get #4 FREE. This will enable you to have the most powerful natural anabolic stack on the market.

**ORDER NOW! C.O.D.'S WELCOME**

**1-800-398-6946** Ask for ext. 120

Send Check or M.O. (Add \$4.00 for shipping)



**S&K LABS**

**COD**

2637 E. ATLANTIC BLVD., SUITE 101.  
POMPANO BEACH, FL 33062

## OUTDOOR CAREERS IN CONSERVATION!

Home study. Qualify for environmental careers in conservation, parks, natural resource programs, more.

Do what you love and get paid for it! Taught one-on-one by professionals. Free career literature: call or send 24 hours a day.

**800-223-4542**

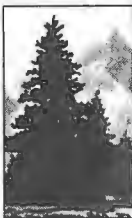

Name \_\_\_\_\_ Age \_\_\_\_\_  
Address \_\_\_\_\_ Phone \_\_\_\_\_  
City \_\_\_\_\_ State \_\_\_\_\_ Zip \_\_\_\_\_

**THE SCHOOL OF CONSERVATION**

PCDI, 6065 Roswell Road

Dept. NNA171, Atlanta, Georgia 30328

## WE SLASH THE COST OF QUALITY CUTLERY SAVE UP TO 50% ON TOP NAME BRANDS!

Call now for your **FREE!**  
**56 page color catalog!**  
(\*Outside U.S. \$5)  
Satisfaction Guaranteed  
Friendly Service  
Fast Delivery

Buck • Swiss Army • BK&T  
Leatherman • Al Mar • SOG  
Blackjack • Benchmade • EK  
Spyderco • Gerber • Boker  
Henckels • Kyocera • Aitor  
Knives • Swords • Tools  
and much more!

**Cutlery  
Shoppe™**

Dept. SF, 5461 Kendall St., Boise, Idaho 83706-1248  
**800/231-1272 • Fax 208/376-7608**

See our catalog on color video



Cross w/ chain \$20.00



War Order Badge \$24.00



Olympics w/ chain \$22.00

These are full size. Not miniatures. Made from originals. We have most complete stock of WWII German badges-caps, etc. in U.S.



**WWII U.S. CAP**  
U.S. Officer's Cap (new from original U.S. maker). Tan with brown leather visor, chin strap and U.S. Eagle pin. State size S, M or L, \$89.00. Have few Olive Drab, Wool \$94.00



**GENERAL'S CAP**  
State S, M or L  
Size=\$110.00. Shoulder Boards, Set=\$31.00. Collar Tabs, Set=\$16.00. Complete, Knights Cross=\$21.00. The Complete Set. IN STOCK. ALL 4=\$149.00



**AFRIKA-KORP. CAP & GOGGLES**  
German 1942 Mfg. ORIGINAL sand & dust goggles. Still in their pocket pouch. Tan Otc. caps=New REPLICA. State S, M or L size, Both Only \$39.00



**U-BOAT CAPTAIN'S CAP**  
White top Gold insignia and visor braid. Leather chin strap. State size wanted \$120.00 Knights Cross with ribbon and oak leaf with swords \$21.00



**S.S. OFFICER'S BLACK VISOR CAP**  
State S, M or L \$84.00 We pay postage.

For the back of your jacket...Flying Tigers BloodChit Patch 7" X 11" good reproduction-\$25.00

**Video**  
Our catalog on VHS video only \$20.00 postpaid free w/ \$25.00+ order.

W.W.#2 Ltd. Box 2063-F, St. Louis, MO. 63158

Do you ever have the feeling that the country is in reverse?  
Going backwards under Clinton's WATCH?  
Here's a watch to remind us. And it's the perfect gift for your friends left of the fence!



*That's Right!  
All Three hands Move Backwards!*

*The Numbers are Backwards Too!*

**Limited Time Offer...act now!**  
Please send Check  Money Order   
Only \$29.95 + 3.00 S&H  
Make checks payable to  
Facets, 576 Aztec Drive  
Boulder, CO 80303

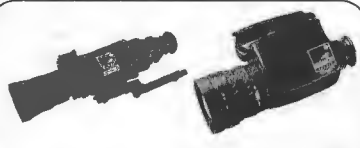

## NIGHT VISION

MoroVision continues to offer one of the widest selections of affordable, high-performance U.S. and Russian made starlight night vision systems available!

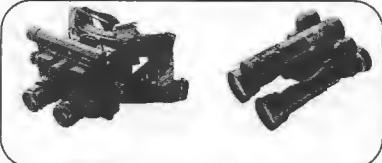

Factory-new binoculars, goggles, weapons sights, pocket scopes, and IR systems from only \$379.00!

Compare our unbeatable low prices and superior service!

**One-Year Warranty** **AMEX**  
**10-DAY MONEY-BACK GUARANTEE!**  
Call Now for Immediate Delivery  
**1-800-424-8222**

**M • O • R • O • V I S I O N**

219 Broadway, Suite 307/SF  
Laguna Beach, CA 92651 U.S.A.  
Info: 714-497-4683 • Fax: 714-497-1270

## \*\* GET TOUGH! \*\*

With the Gentleman's Guide to Street fights and Bar Room Brawls. Guaranteed to show you how to win a fight in ten seconds or less! **Awesomely brutal, amazingly simple.** No fancy, time consuming, hard to learn Hollywood Style Techniques. "Ex-pro wrestler Jack Ringer has lived every word of this incredible book, and guides you through the world of street, bar and parking lot fighting." Deals with single and multiple attackers, restroom fights, improvised weapons, sucker punches, knives and much more. Plus a rare look inside the world of pro-wrestling. Whether you are a contest fighter or have never been in a scrap in your life, this book will make a winner out of you and it will do it practically overnight! **Satisfaction guaranteed or your money back.**

Send \$10.00 plus \$2.00 s&h to:  
**Ringer**  
Rt. 2, Box 326, Bagley, MN 56621.  
MN residents 6-1/2% tax.

# Professional Locksmithing Tools

## LOCKAID

Specifically designed to pick tumbler locks. Designed over thirty years ago to aid law enforcement agencies. Consists of tension wrench, three needles and Lockaid "Gun." Prices include a copy of the book "Lock Picking Simplified."  
**Lockaid \$69.95**



## PIX MODEL 13

This deluxe yet compact kit features 11 of the most commonly used tools. Comes in a slim cowhide leather case for discreet undercover operatives. As a special bonus, a 5 piece set of warded picks is included. A 16 piece set total. Also included, a copy of "Lockpicking Simplified." Receive all this at a Low price of:  
**Pix 13 \$42.95**



## PXP 8

- Shirt Pocket Size.
- Top Grain Cowhide Leather.
- Has 8 Picks, Tension Wrenches and Broken Key Extractor.
- All Picks with Metal Handles.
- Copy of Lockpicking Simplified.

**PXP 8 \$24.95**

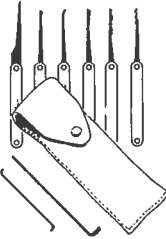

## PXP 10

- Shirt Pocket Size.
- Top Grain Cowhide Leather.
- Has 13 Picks, Tension Wrenches and Broken Key Extractor.
- All Picks with Metal Handles.
- Copy of Lockpicking Simplified.

**PXP 10 \$34.95**

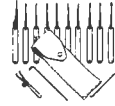

## PIX-EZ All-In-One Pick-Set

100% American Made!  
 As convenient to carry and use as a pocket knife!  
 Only 4 inches long, half inch square, weighs under five ounces, works fast and opens pin and waster tumbler locks quickly, with very little effort. Six tempered spring steel picks, tension wrench.  
**\$34.95**



## WKS PICKS

Made of the finest blue tempered spring steel this 5 piece padlock pick-set is a must in every locksmith's tool box. This set will pick open most every warded padlock made today.  
**\$9.95**



## NEW MONTHLY SPECIAL

RECEIVE A COMBINATION SET  
 INCLUDES — 5 ITEMS

|                                    |         |
|------------------------------------|---------|
| 1-MD-16 DELUXE SET .....           | \$59.95 |
| 1-SCHALGE WAFER SET .....          | \$27.95 |
| 1-SESAMEE DECODER .....            | \$17.95 |
| 1-WKS PICKS .....                  | \$ 9.95 |
| 1-DOUBLE SIDED TUMBLER PICKS ..... | \$27.95 |

A VALUE OF \$143.75  
**AT A LOW PRICE OF \$89.95**

|                               |         |
|-------------------------------|---------|
| Lockpicking Simplified        | \$8.50  |
| Complete Guide to Lockpicking | \$15.00 |
| Improvised Lock Picks         | \$9.95  |
| Tubular Locks                 | \$8.95  |
| Lockout and forced entry      | \$8.95  |
| Involuntary Repression        | \$10.95 |

|                           |         |
|---------------------------|---------|
| Safe & Vault manipulation | \$9.95  |
| How to Pick Pins & Wafers | \$9.95  |
| Combination Locks         | \$8.50  |
| Keys by Impressioning     | \$7.00  |
| Key Casting Manual        | \$8.95  |
| Locks, Picks, Clicks      | \$10.00 |



## ESP-13

This handy new pick set is the most popular set among professional locksmiths today. This kit consists of 12 different tools housed in a handsome black leather case designed for a shirt pocket. Included in the price, you receive a 5 piece warded key set and a copy of "Lockpicking Simplified." 17 piece set total.  
**ESP-13 \$45.95**



## KEY RING PICK SET

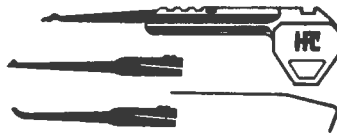

This unique design is ideal when low profile is required or to keep on your keyring for emergencies. Contains a tension wrench, three picks and the "Key Pick."  
**Key Ring Pick Set \$27.95**

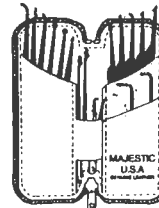

## MD16

Shirt Pocket Size, Top Grain Cowhide Leather, Zippered Case, has 16 Picks, Tension Wrenches and Broken Key Extractor.  
**\$59.95**

## MD32

Hip Pocket Size, Top Grain Cowhide Leather, Zippered Case, has 32 picks, Tension Wrenches, Broken Key Extractor.  
**\$69.95**

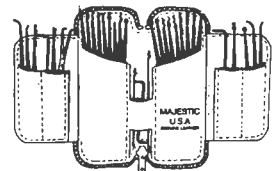

## DOUBLE SIDED DISK TUMBLER PICKS

Set of 4 picks designed to be used on the most popular double-sided disc tumbler, showcase, cam and padlocks.  
**\$29.95**



## MINI PICK TUBULAR

The most effective tubular pick on the market, unlike the larger picks with long handles or screwdriver handles. The longer the tool, the more pressure needed which causes easy breakage. The advantage of the Mini Pick is it is so short, you only use your thumb and index finger. With a little practice this tool will open a tubular lock in less than a minute.  
 A. Your Choice: (1) Center (2) Offset left (3) Offset right; B. "Segal" 8 pin tubular; C. 5-pin Tubular; D. 6-pin Tubular; E. 8-Pin Ace.  
**\$79.95**

## SESAMEE DECODER

This tool was designed to decode the exact combination of a sesame padlock without damaging the lock. Detailed instruction included.  
**\$17.95**



## SCHLAGE WAFER

The most fantastic tool you will ever use. This set consists of two base keys and pick. Complete instructions included.  
**\$29.95**

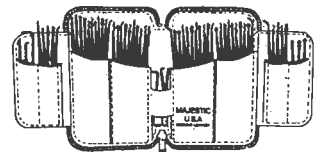

## MD60

Top Grain Cowhide Leather, Zippered Case, has 60 picks, Tension Wrenches, Broken Key Extractor and Warded Master Keys.  
**\$99.95**

Catalog \$3.00  
 Free with order.  
 Sorry, no credit card orders



The law requires all purchases be made in good faith, without make believe or fraud by genuine persons within this industry

Send to  
**Steve Arnold's Gun Room**  
 postage & handling \$5.00  
 Overseas Surface \$6.00  
 Add 30% of total for overseas mail.  
 Must be 18 years of age.

P.O. Box 68, Dept. SF01, Dexter, OR 97431; (503) 726-6360

# CLASSIFIEDS

**CURRENT REQUIREMENTS** — 2.00 per word per insertion — \$40.00 minimum. All ads **MUST BE PREPAID**. Ad copy must be typed or written clearly with authorizing signature, a telephone number (for our files) and full payment. Advertisers offering information packets for a fee must send sample of packet (packets will not be returned). Name, address and telephone number are to be included in your word count. **EXAMPLE:** P.O. Box 693 = 2 words; 80306 = 1 word. Abbreviations such as DI, SGT, 20mm, U.S. count as one word each. Hyphenated words and telephone numbers are counted as two words. No personal services ads accepted. We reserve the right to refuse, delete or change any copy which we determine to be objectionable. Mail classified ads with payment to **SOLDIER OF FORTUNE, Classified Dept., P.O. Box 693, Boulder, CO 80306.**

## NOTICE TO READERS

**SOLDIER OF FORTUNE Magazine** is a magazine of national and international distribution. There may be products for which sale, possession or interstate transportation may be restricted, prohibited or subject to special licensing requirements in your state. Purchasers should consult the local law enforcement authorities in their area.

**READERS OF BOTH DISPLAY AND CLASSIFIED ADVERTISING ARE ADVISED THAT SOLDIER OF FORTUNE MAGAZINE DOES NOT VERIFY VALIDITY OF EVERY ADVERTISEMENT AND/OR THE LEGALITY OF EVERY PRODUCT CONTAINED HEREIN. SHOULD ANY READER HAVE A PROBLEM WITH PRODUCTS OR SERVICES OFFERED BY AN ADVERTISER, HE SHOULD SEEK ASSISTANCE FROM HIS NEAREST POSTAL INSPECTOR AND ALSO CONTACT OUR ADVERTISING DEPARTMENT. SOLDIER OF FORTUNE DOES NOT INTEND FOR ANY PRODUCT OR SERVICE ADVERTISED TO BE USED IN ANY ILLEGAL MANNER.**



## MEET LATIN LADIES!

...Of Central & South America.  
Photos, Videos, & Group Tours.  
Free Brochures! (713) 896-9224

**T.L.C. WORLDWIDE, INC.**  
P.O. BOX 924994  
HOUSTON, TEXAS 77292-4994

**IMPRESSIVE VIDEOS** **FREE** **5 SPECIAL VIDEOS**

Introductory Bonus Offer  
For All New Customers  
enclose \$4 catalog shipping

**Special Offer**  
 15 VIDEOS \$10  
 25 VIDEOS \$15

**For The ADVENTUROUS MAN!!!**

**BARGAIN CENTER Dept. 5015**  
Box 85311 Los Angeles, CA 90072

## TELEPHONE LISTENING DEVICE



Record telephone conversations in your office or home. Connects between any cassette or tape recorder and your telephone line. Starts automatically when phone is answered. Records both sides of conversation. Stops recorder when phone is hung up.

**\$19.95 EACH** Qty. Disc. Avail.



## Super Powerful FM TRANSMITTER

Many times more powerful than other transmitters. Transmits up to 1/4 mile to any FM radio - Easy to Assemble Kit - up to 9V battery (not incl.) For catalog of Transmitters, Voice Scramblers and other specialty items, enclose \$2.00 to USI Corp.

Call 407-725-1000 or send \$19.95 + \$1.00 shipping per item to: USI Corp, P.O. Box SF-2052, Melbourne, FL 32902 COD's OK

## WAR COPS

Exclusive documentary on the U.S. invasion of Panama. Follow the 108th Division as they restore hope to Noriega's Hell on Earth! Unreleased footage of:

- The Spector-computerized aircraft assault
- Drug busts Central American-style
- Death at a traffic barricade
- Ground fighting
- Interviews with VP Quayle; commandos

Shot on Beta SP, mastered in Los Angeles  
Send \$21.95 (specify VHS/S-VHS) to:

WarCops, 307 E. Ash, Ste. 24, Columbia, Missouri 65201 (Distributors Wanted)

Running time: 45 min. Allow 2-4 weeks

## EMERGENCY PASSPORTS TRAVEL INCOGNITO

**AFRAID TO TRAVEL AS AN AMERICAN? NEED ALTERNATE IDENTIFICATION?**  
FOR TRAVELERS AFRAID OF BEING SINGLED OUT BY TERRORISTS, HIJACKERS OR KIDNAPPERS, WE OFFER PASSPORTS FROM VARIOUS COUNTRIES.

**"AN AMERICAN? — NOT ME!"**  
CUSTOM MADE LEGAL SECOND PASSPORTS WITH YOUR PHOTO AND PERSONAL INFO PLUS TWO BACK-UP I.D. CARDS - \$150.00  
SEND \$2 FOR INFO AND BROCHURE

**SAFEGUARD SERVICES**  
P.O. Box 689-F Ely, NV 89301  
(702) 289-4229

## UNUSUAL BOOKS

MANY AVAILABLE NOWHERE ELSE  
100's of Titles to Choose!

CREDIT • EMPLOYMENT • EXOTIC WEAPONRY • MARTIAL ARTS • PRIVACY • NEW IDENTITY • DISGUISES • SURVEILLANCE • FIREWORKS and Much, Much More!  
Best Prices and Selection. Money Back Guarantee.  
Catalog . . . . \$1.00

**ALPHA PUBLICATIONS**  
PO Box 308-M Sharon Center, OH 44274

**THAI TIGERSTRIPE UNIFORMS**, worn by Special Forces & S.E.A.L.s in Vietnam, Jacket & Pants \$74.00, Boonie Hat \$17.00, Marine Cap \$17.00. A.H.A., Box 21606, Denver, CO 80221. (207)

**VIETNAM MEMORIAL T-Shirts** in an unforgettable & riveting, eye catching design. Black or gray, small to XXL. Embroidered caps, black, \$16.95 each. NAM'er, P.O. Box 129, Brackney, PA 18812. (209)

**T-SHIRTS**, Bumper Stickers, Patches, more! FREE Catalog. SASE to 8717-F Ontario Drive, Fort Worth, TX 76108. All items guaranteed! (207)

**YOU'LL LOVE 'EM**, but will you have the guts to wear them? "In Their Face" T-shirts by Royal-T-Enterprises. Statements on such subjects as Gun Control, Hunting, Government arrogance and the spotted owl. Call 1-800-676-1412 for free color brochure. Allow 30 seconds for message to come on. (207)

## BOOKS & PUBLICATIONS

**SOLDIER OF FORTUNE Magazine Binder**. Holds 12 issues, \$12.00 plus \$4.00 P&H. VISA/MC accepted. No COD's. **SOF BINDER**, P.O. Box 693, Boulder, CO 80306. (212)

**MEN OF ACTION AND ADVENTURE** - Paladin Press has been described as "the most dangerous press in America." Millions of satisfied readers disagree. Outrageous and controversial books and videos on firearms, exotic weaponry, new identity, creative revenge, espionage and investigation, privacy, action careers, and more! To order our 64-page catalog send \$2.00 to: **PALADIN PRESS**, Box 1307-5AQK, Boulder, CO 80306, (303) 443-7250 (212)

**BOOKS ON AFRICAN WARS**, hunting, politics. Catalogue \$2 write: Lemur Books, P.O. Box 1645, Alberton, 1450, SOUTH AFRICA: Fax 011-869-0890 (209)

**WHO KILLED KENNEDY?** Assassination research materials: Videocassettes, photographs, books, unpublished manuscripts, Catalogue: \$3.00. Collector's Archives, Box 2, Beaconsfield, Quebec, H9W 5T6 CANADA. (216)

**MILITARY/INFO PUBLISHING**. We produce unique books on Military Science and Technology. For free catalog. Write: Military/Info, P.O. Box 27640-SF, Golden Valley, MN 55427. Announcing for sale, more books in our Antiarmor Series: "US Law M72", and "Swedish AT4." Also our new book "Artificial Cave Shelters". Each for \$10.00 plus \$4.00 shipping. (207)

**ART OF THE BLADE Magazine**. This magazine is for all martial artists, edged weapons enthusiasts and today's modern soldier. Makes a great gift! Send SASE for info or \$16.80 for one year subscription. Canada add \$6.00 shipping. All other countries add \$10.50 shipping. U.S. Funds only. **RONIN PUBLICATIONS**, 34-3 Shunpike Rd., Dept 162, Cromwell, CT 06416. (207)

**SPECIAL FORCES Peak Conditioning Manual**. Train and look like the men in SF. Includes Diet, PT, Running, and Weightlifting Routine. Get strong and tough! **RUSH \$11.95 to THE ELITE**, P.O. Box 600130, Lake Hiawatha, NJ 07034. (208)

**ULTIMATE GUERRILLA HANDBOOK** "Manual for War." Proven under fire! Only \$11.45 postpaid. **ATLI PRESS**, Dept 5, P.O. Box 7768, Chicago, IL 60680-7768. (207)

**SURVIVALISM LIVES!** Get 12 big monthly survival newsletters and membership in the oldest and most respected survival/self-reliance organization in the world. \$2.00 information pack. \$20.00 full year membership. **LIVE FREE**, Box 1743, Harvey, IL 60428. (207)

## U.S. GOVERNMENT LAND

Federally owned land currently available in AK, AZ, AR, CA, CO, ID, MT, NV, NM, OR, UT, WA, WY for **\$2.50 per acre**. U.S. citizens entitled to purchase **up to 160 acres per person**. For complete information package including maps, telephone helpline, filing forms, etc. send \$20 check or money order to: **FEDERAL LAND CO., Dept L, Box 21598, Washington, DC 20009**. (Note: this is not homesteading—lands are sold outright.) **MONEYBACK GUARANTEE!**

## APPAREL

**FRENCH FOREIGN LEGION T-Shirt** with Legion Motto in French and Latin! \$10.00 each! **WOLFGANG**, Box 709H, Prudenville, MI 48651. (207)

**MILITARY UNIFORMS** From Around The World! New Updated Catalog of Rare & Unique International Military Camouflage Uniforms and Equipment. \$1.00. A.H.A., Box 21606, Denver, CO 80221. (207)

**FREE CATALOG!** Screen printed sportswear military and paramilitary designs. Send to: **THE HARDLINE**, 999 E. Fry Blvd. #306, Sierra Vista, AZ 85635. (207)

**NEW!** "Don't Tread On Me" T-Shirts/Caps. Famous Revolutionary War Protest Slogan. Postcards, address labels, more. Free Catalog: **DESIGNS**, Box 2791/S15, Apple Valley, CA 92307. (207)

**\$580 FROM \$99!**

**AGAIN AND AGAIN!!**

**Global Currency Exchange Rate**  
flaw allows this easily and legally!  
Become a currency exchange  
professional earning THOUSANDS!!  
Send \$2 to: WCC  
P.O. Box 4036 • Miami, FL 33116

**UNDERGROUND BOOKS**

- Censored ..... \$25
- The Outlaw's Bible ..... \$15
- Personal Defense Weapons ..... \$10
- Censored ..... \$22
- Censored ..... \$24
- Shadowing and Surveillance ..... \$15
- Privacy, and How to Get It ..... \$18
- The Paper Trip I ..... \$17
- Underground Book Catalog ..... \$3
- Adults Only! CA Res. Add 7.75%
- Free Shipping! Fast Service!
- Visa/MC Orders Call 800-635-8883
- Customer Service 916-725-0341
- FAX Your Order 916-725-8848
- Checks & Money Orders Accepted
- FS Book Co., P.O. Box 417457
- Dept. SF, Sacramento, CA 95841

**Gunvertor® Universal T.V. Remote**

**\$39.88**

Trigger changes channels on your T.V., VCR, cable box or a 2nd T.V. Works on all brands. **Satisfaction Guaranteed!** Free color catalog of adventure gear with your Gunvertor® order. Credit Card Orders 1-800-777-7732. Product 8769SFGU.

**U.S. CAVALRY**



**PAGER HOLSTER**



•Fast, Safe, Discreet •Press Button, Case Front Pops Open  
•Hinges Down Allowing Quick Draw of Gun •Clips to Belt •Fits: Bauer, Davis Derringers (.22, .25, & .32), Baby Browning .25 Autos, PSP & Iver Johnson .25, NAA 22 LR 1 1/8" BBL, Freedom Arms 22 LR 1" BBL

SeeR, Inc.  
P.O. Box 20983  
Waco, TX 76702-0983

\$19.95 each  
plus \$2.00 postage & handling  
TWO for \$34.95 plus p & h

**AK SKS MAK90**



**SEND OR CALL FOR FREE COLOR CATALOG**

Catalog containing rifles, parts, accessories, scopes, mounts, stocks, magazines, muzzle brakes and 100's of other products for SKS, MAK90, Hakim, AK 47 and other firearms.

**FEDERAL ARMS CORPORATION** of America



7928 University Avenue N.E.  
Fridley, MN 55432  
612-780-8780 • FAX 612-780-5747

**GORGEOUS ASIAN WOMEN**

DESIRE PENPALS, ROMANCE, MARRIAGE!

Details, color photos — \$1:  
P.I.C., P.O. Box 461873-SF,  
Los Angeles, CA 90046



**YOUR MILITARY MEDALS!**



**LARGEST INVENTORY IN THE U.S.A.!**

- FULL SIZE US MEDALS
- UN AND RYN MEDALS
- MINIATURE MEDALS
- OFFICIAL RIBBONS
- RANK BADGES . PATCHES.... ALL GUARANTEED!
- SKILL BADGES
- DISPLAY CASES
- MANUALS ON CLAIMING MEDALS

SEND \$2.00 TODAY FOR ALL NEW COLOR CATALOG!

**MEDALS OF AMERICA**  
1929S2 FAIRVIEW ROAD  
FOUNTAIN INN, S.C. 29644

**BEATING RETREAT (60 Minutes)**  
VHS ONLY \$39.95  
By the massed bands of the Royal Marines. A spectacular rousing performance.

**BRITISH REGALIA IMPORTS**  
Department 6  
P.O. Box 50473, Nashville, TN 37205

**CONSTITUTIONAL PATRIOTIC TALK SHOWS SIX HOURS A NIGHT!**



Buy direct! Qty. discounts! AC 101

Don't develop an ulcer listening to Liberal trash on TV. This digital/programmable shortwave radio picks up professional American broadcasts that inform us about the "New World Order" and the destruction of the Constitution. For FREE info send SASE, or send \$49.95+\$4.00 S&H to:

E.I.S., P.O. Box 2415-SF, Youngstown, OH 44509.  
Credit card orders only (MC/VISA) (800) 456-8770.  
Orders shipped in one week!

**Baseball style Morse Code Cap**

translates to: F \_\_\_ Off  
1 For \$15.00 2 for \$25.00

F \_\_\_ Off  
Adjustable Embroidered

SAC Co. Free Shipping  
P.O. Box 258  
Accord, MA 02018

Made in USA

**BUSINESS OPPORTUNITIES**

LET THE GOVERNMENT FINANCE your new or existing small business. Grants/Loans to \$500,000. Free recorded message: (707) 449-8600. (KW5) (210)

**COLLECTORS**

**MILITARY COLLECTIBLES:** WWI/WWII/Korea/Vietnam. CURRENT: Patches/Badges/Rank Insignia/etc. Catalog \$4.00. Phone (408) 295-1136 or FAX (408) 288-6350 or write: LEE-JACKSON MILITARIA, P.O. Box 8663, San Jose, CA 95155-8663. (208)

**VIETNAM WAR INSIGNIA and Uniform List.** I mail a list of Vietnam War Militaria six times per year. Buyers receive a list free, others pay \$3 per list. Insignia are pictured so you know what you are buying. I always have a nice collection of original patches, insignia, books, maps, uniforms, field gear etc. Both U.S. and VC/NVA. I also buy singles and collections of Vietnam War souvenirs. 100% guarantee from me. Buy with confidence. BILL BROOKS, P.O. Box 230832, Montgomery, AL 36123. (217)

**BRITISH/SCOTTISH Militaria Collectors.** Regimental insignia and accessories of elite Regiments; including SAS; Paratroopers; Royal Marines; Black Watch; Guards, etc. Import Catalog \$6.00. BRITISH REGALIA IMPORTS, Department 6, P.O. Box 50473, Nashville, TN 37205. (207)

**World's Most Fascinating Police Catalog!**

112 pg. Catalog  
Badges; ID Cards;  
Books; Clothing;  
Ammo; Weapons  
Spy Equip; Posters;  
Hats & more!  
World's Best Catalog!

Send \$3.00 for Catalog, or Call 1-900-226-2444 for RUSH shipment! FREE \$3.00 Coupon included with each catalog!

NIC, Inc. Box 5950-FC, Sport, LA 71135; (318) 688-1365

**WWII RELICS!** Cheaper than certain "well-known" relics dealers! We beat their prices for flags, daggers, medals, helmets. Illustrated catalog \$5.00 (refundable). Telephone: (612) 689-1146. MILITARIA, Box 261-D, Cambridge, MN 55008. (209)

**INTERNATIONAL MILITARIA!** New Winter Catalog of Military Berets, Equipment & Camouflage from around the world. \$1.00, I.M.S., Box 21606, Denver, CO 80221. (207).

**RHODESIAN AND SOUTH AFRICAN** badges, medals, and uniforms to sale. For a list send \$1 to KAPLANS, Box 890638, Lyndhurst 2106, South Africa. (xxx)

**DOCUMENT COLLECTOR.** Top dollar paid for original, unused military papers such as DD-214's, evaluation reports, etc. Li, 1605 George Dieter #651, El Paso, TX 79936. (207)

**EDUCATION**

**TERMPAPER ASSISTANCE.** 19,278 topics available! 306-page catalog—rush \$2.00. Research, 11322 Idaho, #206EX, Los Angeles, CA 90025. TOLL-FREE HOTLINE: 800-351-0222 or 310-477-8226. (214)

**EMPLOYMENT**

**OVERSEAS, STATESIDE.** \$100-\$1,000 daily. Now hiring. FREE list. ZINCS 117, Box 585, Dearborn, MI 48120 (208)

**PROFESSIONALLY** Crafted Resumes and Job Search Books/Reports. Money back guarantee. FREE information: DMDSOF, P.O. Box 322, Natrona Heights, PA 15065. (209)

**SECRETS OF OVERSEAS** Employment Revealed. Work in paradise. Earn Tax Free Income. Send \$9.95 to I.E.S., 15327 Sunset Blvd. #106, Pacific Palisades. CA 90272. (209)

**COURSES -**

- COMBAT
- RECONDO
- SPL. OPS.
- SNIPER

BROCHURE \$5.00 Cash

SPECIAL OPERATIONS GROUP INT.  
P.O. BOX 94, TRADE, TN 37691 USA

**DO YOU KNOW THE ENEMY!** Intellicom INC does. Do you need open source military information on any of the world's aggressor countries like: Haiti, Cuba, Iran, Iraq, Lybia, North Korea? If so, two dollars for brochure to: 42 Cedar Brook Drive, Somerset, NJ 08873. (207)

**BELT-FED SHOTGUNS** convert Remington 1100/Browning A-5's to 25 round belt fed. Fully illustrated step-by-step plans. \$15 Kephart Publications, 495 PVR, Murphy, NC 28906 704-837-8067. (207)





# Need NEW ID ? CREDIT • PRIVACY •

OUR BOOKS HELP YOU GET: New Identity & credit.  
• Jobs in 48 hours. College degrees. ID by mail.  
• Cash income. Private loans. Asset protection.  
• Offshore banking. Foreign passports & MORE!  
FREE 40 pg. **PRIVACY CATALOG**: 800-338-8484  
EDEN PRESS • Box 8410-PS • Fountain Valley, CA 92728

## Russian Ladies, truly beautiful, want to meet you!

260 Beautiful, Educated Russian Ladies are sincerely seeking friendship and marriage with American men of all ages. We have selected these ladies from over 4800 applicants.

FREE Color Photo Brochure

### RUSSIAN CONNECTION

Dept. 100 • P.O. Box 888851 • Atlanta, GA 30356  
(404) 458-0909 (24 hours)  
EXCITING MOSCOW TOURS AVAILABLE



**ATTENTION!!**  
The "World Constitution" for the New World Order Is Now Here!!!  
Order this 63 page document today to see how it will affect your future!!!  
Send \$10.00 + \$2.00 Shipping to:  
S.O.S.  
P.O. Box 5297  
Titusville, FL 32783-5297  
VISA/MC Accepted  
FAX # 407-269-9466

**SOLID BRASS PAPER WEIGHTS**  
Made from 1/2 lb of solid brass. Polished to a smooth finish  
**\$12.95 Each or 2 for \$22.50**  
Send check or money order plus \$4.00 Shipping & Handling to:  
Bud K World Wide MC or VISA call  
P.O. Box 565 Dept SF 1-800-543-5061  
Moultrie, GA 31776

**BEAMSHOT™ 2000**  
Laser Sight FDA APPROVAL PATENTED

Retail: **\$99.00**  
Including:  
• Laser Sight • Mount • Gun Case • Battery  
**1 year warranty**  
• Click Alignment System • Window Lens • Water Resistant  
Please call the dealer near you or 800-520-8435  
**Quarton USA, LTD. CO.**  
7042 Alamo Downs Parkway, Suite 250,  
San Antonio, Texas 78238-4518  
Tel: (210)520-8430 Fax: (210)520-8433

**BEAUTIFUL MEXICAN WOMEN** seek romance!!  
Free photos, full information. LATINS, Box 1716 (TN), Chula Vista, CA 91912. (619) 425-1867. (207)

**YOUR FBI, CIA, IRS RECORDS & more!** \$49.95 plus \$6 shipping plus name, SSN, birthdate & place: BLUETREE, Box 4177FX, Mountainview, CA 94040. (210)

**MILITARY KNIGHTS** of the Noble Order of the Tower. Free Information. Office of the Grandmaster, 3310 Tyrone, El Paso, TX 79925. (207)

**OFFSHORE BANKING INFO** package US\$ 15 plus US \$5 S&H. Mueller & Associates, PO Box 300 202, 51412 Berg, Gladbach, Germany. (209)

**BUILD MUSCLES! BURN FAT! FAST!!!** "24 minute" routine works "miracles!" Free details. Kisha, Box 147, Dept. C2, Duquesne, PA 15110. (207)

**MEET BEAUTIFUL ASIAN COEDS** through correspondence. For free photo brochure write to: The Phil-Arm Connection, 366 N. Allen Avenue, Suite 331-F, Pasadena, CA 91106. (207)

**OPTICS**  
**BINOCULAR WAREHOUSE** - Zeiss, Loica, Swarovski, Steiner, Nikon, Pentax, Minolta, plus much more! All Discounted - Send \$1.00 for catalog. 6635 San Pedro, San Antonio, TX 78216 or call 210-525-9000. (207)

# BUGGED??

**EAVESDROPPING** is unbelievably widespread! Electronic Devices with amazing capabilities can be monitoring your telephone and room conversations **RIGHT NOW!** Are you sure you're safe? **FREE CATALOG** tells you fast! Includes Free Bonus details on fantastic opportunities now open in Counter-Surveillance field. Exciting, immensely interesting and **EXTREMELY** profitable (up to \$250/hr) full/part-time income. Call Now! **1-800-732-5000**

Men & Women! Be A ...  
**PRIVATE EYE**

Amazing one-of-a-kind home study course tells all! Want a life of intrigue, excitement, adventure?! Quickly learn from the experts:

- How To Earn **\$100,000** A Year As Your Own Boss!
- How To Conduct All Types Of Private Investigations, Skiptracing & Surveillance!
- How To Start Your Own Private Detective Agency!
- How To Work From Home, Part-Time or FullTime!
- No Experience Necessary, No Investment Required!

**STATE APPROVED**  
Located in the Entertainment Capitol Of the World! **(213) 879-1165**

**FREE DETAILS**  
UNITED STATES ACADEMY OF PRIVATE INVESTIGATION  
P.O. BOX 2133 (SF)  
BEVERLY HILLS, CA 90213

**REGIMENTAL INSIGNIA & WEAPONRY**

- SAS • RAF • BLACK WATCH
- PARA • RM • CAMERONS
- RSDG • RN • GUARDS etc.

Import Catalog \$6.00  
**BRITISH REGALIA IMPORTS**  
Department-6  
P.O. Box 50473 • Nashville, TN 37205

Personally Signed To You  
**"COMBAT BABE"**  
**\$10 POSTERS**  
MISS BUSY BODIES, Inc.  
2809 Bird Ave., Suite 269  
Miami, FL 33133  
Visa/MC 1-800-240-5755

## PROFESSIONAL IDENTIFICATION

**TIRED OF PONEY LOOKING DO IT YOURSELF I.D. CARD KITS?**  
WE HAVE STATE OF THE ART PVC CREDIT CARD QUALITY I.D. CARDS WITH YOUR PHOTO AND EMBOSSED DATA.  
**THIS IS THE SAME TECHNOLOGY AS THE NEW VISA PHOTO CARD.**  
GET RID OF THE "KIT I.D." AND MOVE TO TODAY'S TECHNOLOGY.  
SEND \$2 FOR A COLOR BROCHURE  
**SAFEGUARD SERVICES**  
P.O. Box 689-F Ely, NV 89301  
(702) 289-4229

## REMAILING SERVICES

**CONFIDENTIAL ADDRESS.** Mail received here, then forwarded to you worldwide. Voicemail, too! MAILPOST, 2421SOF Pratt, Chicago, IL 60645 (312) 764-0100, (800) 890-3199. (207)

**PRIVATE MAIL** Receiving and Forwarding Service. Confidential and Economical. Worldwide. POS, Dept 2A, 4195 S. Tamiami Trail, #173, Venice, FL 34293. (209)

**CONFIDENTIAL GERMAN** mailing address & office service info: B.M., PO Box 300 202, 51412 Berg, Gladbach, Germany. (209)

## SECURITY PRODUCTS

**SECURE VOICE TURNS PC** into powerful voice encryption machine. \$100/pair. FAX (817) 322-4953 for info. (207)

**SECURITY AND SELF DEFENSE** Equipment, Knives, Swords, Crossbows, and Martial Arts accessories. Send \$2.00 for 16 page color catalog to: S&R Imports, P.O.Box 4684, Virginia Beach, VA 23454. (207)

**SURVEILLANCE, Counterspy, Protection!** Guaranteed lowest prices! Two best catalogs available \$5.00. PROTECTOR, Box 520294-S Salt Lake City, UT 84152. (801) 487-3823. (207)

## SURPLUS

**MILITARY CLOTHING,** Gear, Boots, Jackets, Collectibles, etc. Call (408) 295-1136 or Fax (408) 288-6350 for FREE catalog or write: LEE-JACKSON MILITARIA, P.O.Box 8663, San Jose, CA 95155. Foreign catalogs are \$4.00. (208)

**MILITARY SURPLUS & Survival Items;** Large inventory, new and used. Mail \$1. (refundable) for price list: HUGH WADE'S, 2120 West Reelfoot Ave., Union City, TN 38261-9732. (207)

**FREE** FULL YEAR SUBSCRIPTION...  
**SamAndy SURVIVAL TIMES**  
NEWSLETTER & CATALOG  
BE PREPARED! HELPFUL TIPS & PRODUCT FACTS HELP YOU FACE THE FUTURE WITH CONFIDENCE - NO MATTER WHAT! YOU OWE IT TO YOUR FAMILY TO HAVE THIS INFORMATION - FOR YOUR FREE 1 YEAR SUBSCRIPTION - SEND YOUR NAME, ADDRESS & PHONE #.  
SamAndy SURVIVAL TIMES NEWSLETTER, DEPT J44  
P.O. BOX 141741, IRVING, TEXAS 75014  
FAX # 214-869-2087 DEPT J44

**BECOME A "LEGIONNAIRE."** The United States Special Operations Group needs volunteers. Send \$8.00 M.O. for application to Gen. L. Gray, S.O.G., P.O.Box 464294, Lawrenceville, GA 30246. (207)

**NEW IDENTITY!** Everything included to completely change identity. Driver's License, Social Security, Birth Certificate, Identification Card, Complete Instruction Booklet. Send \$29.95 to "CAS", P.O.Box 2392, Redondo Beach, CA 90278. (207)

**FREEDOM COUNTRY**



20 BIG acres in WESTERN MONTANA, starting at \$9850. Trout fishing, backpacking, camping. Elk, deer, moose, bear. ADJACENT to National Forest, near established towns. Yellowstone and Glacier National Parks nearby. **GUARANTEED ACCESS, INSURED TITLE, WARRANTY DEED. FREE** color brochure, photos, maps.

FULL MONEY-BACK GUARANTEE  
"Video Available"  
CALL TOLL FREE 1-800-592-5990  
**TREASURE STATE RANCHES**  
210 Milwaukee Street, Dept. S  
Deer Lodge, Montana 59722 — (406) 846-1000

HAT PINS - PATCHES - FLAGS

1500+ MILITARY DESIGNS  
FREE 24 Page ILLUS. CATALOG  
WE DO CUSTOM WORK  
Dealer Inquiries Welcome

**HOOVER'S MFG. CO.**  
4015SF PROGRESS BLVD.  
PERU, IL 61354  
(815) 223-1159, Ask For David

BEER MUGS T-SHIRTS

**Street Lethal SPEED KILL**

Can you hit a man 11 times or more in one second or less?  
Can you drop a man to his knees with one blow?  
Can you win a fight in 3 seconds or less?

WE TRAIN PEOPLE WHO CAN! FREE DETAILS  
Warrior Publications  
6252 Dark Hollow Rd., Medford, OR 97501 (503) 535-3188  
CUT OUT AND MAIL THIS AD TODAY!

**MILITARY SURPLUS.** New and used, also survival items. Send \$2 for catalog. REMA MILITARY SURPLUS, P.O. Box 7039, Canton, OH 44705. (207)

**CAMOUFLAGE UNIFORMS** From 45 Countries! Current Listing \$1.00. A.H.A., Box 21606, Dener, CO 80221. (207)

**SURVIVAL**

RIOTS, FIRES, FLOODS, EARTHQUAKES catch people off guard! Survive disasters. Ultimate U.S. life saver secrets revealed: "Emergency!!" guidebook. \$9.95 guaranteed. Write now! Deweyguides, 3800 Dewey Avenue, Box 125SF1, Rochester, NY 14616. (207)

**SMOKE GENERATORS** and numerous other wondrous things. Write for 56-page catalogue of 500 products. U.S.-\$3.00, Canada-\$5.00, others-\$10.00. Signus, Box 33712-W59, Phoenix, AZ 85067-3712. (207)

**RAVEN ENTERPRISES PROUDLY PRESENTS:** The Solar Still! Designed to be built quickly and easily out of common everyday items, it could save your life! Don't be caught unprepared! For complete instructions, send check or money order for \$5.99 to: Raven Enterprises 211 S. State College Blvd., Suite #416, Anaheim, CA 92806. Please allow 4-6 weeks for delivery. (207)

**TRAINING**

**BOUNTY HUNTER TRAINING** by professionals; on-site in Florida or at country-wide seminars. Details. NABEA, P.O. Box 1170, Tombstone, AZ 85638. 1-602-457-9360. (207)

**RANGER, AIRBORNE,** Bodyguard Training. Catalog and information \$7.00 (\$12.00 Foreign). USTC, 2024 N. Broadway, Suite 205, Santa Ana, CA 92706-2623. (714) 547-2567. (212)

**NAVY SEAL FITNESS** Program. Gain strength and self-confidence. Get in shape using the methods of the world's most elite combat unit. Send \$10.95 to: T-N-S ENT, P.O. Box 16297, Seattle, WA 98116. (208)

**CATALOG** for special interests. Info that has never before been published by former SPecOP Personnel. Rush \$1.00 to: Absolute Services, Inc. 18215 Highway 99, Linnwood, WA 98037. (207)

**TRAVEL**

**R & R FOR SINGLE MEN.** Dream vacation with beautiful, playful Filipinas, as featured on "Inside Edition". Big Apple Oriental Tours(SOF), 24912 Elkmont Avenue, Bellerose, NY 11426. (207)

**SURVEILLANCE**  
& COUNTERSURVEILLANCE Electronic Devices

Covert Video Cameras • Transmitter Kits • Voice Changers  
Bug and Phone Tap Detectors • Shotgun Mics • Micro Recorders  
• Vehicle Tracking • Locksmithing • AND MORE!

"IMPROVED" 7-Hour Telephone Recorder  
Tapes incoming/outgoing phone calls automatically. \$125.00

FOR CATALOG SEND \$5.00 TO... **SPY OUTLET**  
P.O. Box 337, Buffalo, NY 14226 (716) 691-3476

**PHOTO ID CARDS**

Drivers Licenses  
Social Security Cards  
Birth Certificates

**MILITARY CERTIFICATES**

Martial Arts Diplomas  
Law Enforcement Certificates  
College Degrees

CALL NOW Free 24  
TOLL FREE Brochure HOURS  
(800) 354-7555

Miller Publishing Co., Dept. SOF  
7850 White Ln., E330  
BKFLD, CA 93309

**Telephone Listening & Recording Devices**

MA-100 Devices Hidden in Dual Modular Adapters!  
FM Transmitter MA-100 DMR-20 Recording Adapter

Crystal clear reception on FM radio up to 1/4 mile  
SnapKit uses phone line for power & antenna

Starts & stops recorder when phone is used  
Plugs into standard cassette recorder  
Works when any phone in house is used

\$25.95 free shipping Visa/MC (214) 255-7490 \$29.95  
Seymour-Radix Inc. Box 168055-SF Irving TX 75016

**THAI ASIAN WORLDWIDE**

LADIES 270 Photo Catalog  
Beautiful Women Around  
The World Seek Loving Men  
TAWL Box 937(SOF) Kailua-Kona, Hawaii 96745. FREE  
Brochure 808/329-5559



**PHILIPPINE R&R TOURS,** an experience others only dream about. Sample video and brochure send U.S. \$10.00. Asian Encounters, P.O. Box 5828, Bellingham, WA 98227. Phone (206) 734-5254. (208)

**VIDEOS**

**COVERT KNIFE FIGHTING** (tape, documentation, 2 concealable weapons (superior to brass knuckles). Ck/MO \$55.00. S.D. TEC, 1902 Ridge Rd., Buffalo, NY 14224 (207)

**"THE NAVY SEAL WORKOUT CHALLENGE"**  
Awesome new exercise video. Mission Objective: Tone muscles and increase endurance. This video shows you how Navy SEALs get and stay in shape. Learn the physical training secrets of the Navy SEALs. 75 minutes of nonstop action. This is the real thing. Grab a sweat towel, crank up the volume, and accept the challenge! Get buff with the Navy SEALs. Only \$19.95 includes shipping. Send check or MO to Sand Bee Corporation, P.O. Box 960311, Miami, FL 33296. (305) 279-3393. Dealer inquiries welcome. (207)

**LOOKING FOR** beauty, love, devotion, good character? Meet Philippines' ladies on video, personally. P.O. Box 7031, Phillipsburg, NJ 08865. (207)

**SEXY ORIENTAL BABES** want older men for romance and marriage. 250 girl video \$16.95. Photo catalog \$2. VOYAGE, 41 Sutter, #1309-R, San Francisco, CA 94104. (207)

**COMBAT VESTS**  
AND SPECIALTY EQUIPMENT

NO CHEAP MESH OR NOISY VELCRO  
ALL VESTS FROM \$99.95 TO \$129.95  
USING ONLY U.S. MILSPEC MATERIALS  
SEND SASE FOR FREE MINI-CATALOG

**FMCO** P.O. BOX 4732, A/SOF  
MEDFORD, OR 97501-0195

**SKELETON KEY**

FITS MOST LOCKS  
(bollocks, doorlocks, & some padlocks)  
Amaze Your Friends



With A Lock Picking Demonstration. You get 3 sized metal tension keys, the slide pick, precise instructions & more. Note: This device is to be used for demonstration purposes only! Satisfaction Guaranteed or Full Refund; 2 weeks delivery.

To get this exciting device. Send NOW ONLY \$8.95 + \$2 S&H to:  
Safe Marketing \* 90 W. Montgomery Av No.366SF \* Rockville Md 20850

**ARREST Violators!** **Wear the Badge of a DETECTIVE**

TRAIN FAST AT HOME  
BE YOUR OWN BOSS!  
USE SECRET EQUIPMENT

NO PREVIOUS TRAINING NEEDED

Your spirit of adventure, danger, and self reliance can lead you to an exciting career opportunity. Solve mysteries, bring criminals to justice, protect the innocent. Experts guide you every step of the way. Men and women needed to work in challenging situations, withstanding hardships, make you on the spot decisions. Learn the latest investigative techniques using special law enforcement equipment . . . the same equipment used by the FBI, the CIA, and the Secret Service. Start your own investigative agency. Save up to 25% and more on all equipment. Send for free details.

Approved by Calif. Dept. of Public Instruct.

**THE ROUSE SCHOOL of Special Detective Training**  
Dept. SG501 P.O. Box 25750, Santa Ana CA 92799

Name \_\_\_\_\_ Age \_\_\_\_\_  
Address \_\_\_\_\_  
City/State/Zip \_\_\_\_\_

**NUDISM LIFESTYLE:**  
**FAMILY RECREATION**  
Publications • Videos  
\$3 for details:  
LIFESTYLES-SF  
Box 661268, Los Angeles, CA 90066

**ISRAEL MILITARY PRODUCTS**



**AIRBORNE T-SHIRT S-XXI \$11+\$3 POST**  
IDF WEBBING, HELMET, INSIGNIAS, UNIFORMS, T-SHIRTS  
CATALOG \$2 (FREE WITH T-SHIRT ORDER)  
IMP P.O.B. 31006, TEL AVIV 61310, ISRAEL

**TRAINING CENTER VIDEOS** civilians can't find for rent! SECRET cop, camo, Marine, mercenary pursuit, disarm/disable, capture, resistance, restraint, interrogation, escape videos. Can you survive these action-adventure documentation of real weekend warrior maneuvers? Plus: Cop Olympics wrestling, boxing, power lifting, body building. Free Brochures: P.D. SPORTS, 2755 Blucher, Seb, CA 95472. (208)

**WANTED**

**PROFESSIONAL BODYGUARDS & Investigators!**  
If you feel you have the potential to earn \$80 per hour. If you are professional and can assimilate confidential information. ACT NOW! Send \$10 for full information package to B.A.S.E.C., P.O. Box 147, Convent Station, NJ 07961-0147. (209)

# PARTING SHOT

## Securing A Free State

by Samuel Francis

**W**ith the collapse in the past year of the political opposition to federal gun control laws, with the *defection of the Republican Party* on the issue and the inability of the so-called "gun lobby" to stop legislation like the Brady Act and the recent ban on semiautomatic weapons, it ought to be clear to Americans who support the right to keep and bear arms that they're going to have to fight their battle in the courts.

That is not an enticing prospect. Except for a few Second Amendment

stance of that scholarship appeared this year in the *Duke Law Journal* by none other than the distinguished legal scholar William Van Alstyne, a certified liberal. Mr. Van Alstyne, the William R. and Thomas L. Perkins professor of law at the Duke Law School, is not exactly your stereotype of a gun nut.

He's long earned the wrath of political conservatives for his opposition to conservative judicial appointments and a number of conservative constitutional measures. His view in "The Second

that is the key to their thinking about keeping and bearing arms.

"There are doubtless certain national constitutions that put a privileged emphasis on the security of 'the state,' " Mr. Van Alstyne writes, "but such as they are, they are all *unlike* our Constitution ... such constitutions make no reference to any right of the people to keep and bear arms."

They do not do so, he argues, quite simply because "they reflect the belief that recognition of any such right 'in the people' might well pose a threat to the security of 'the state.'" The framers of the Second Amendment did not want that kind of state and didn't intend to construct one. What they wanted was a "free state," and in a free state they knew the people had to have arms.

This was the explicit argument of James Madison, the Father of the Constitution itself, in *Federalist No. 46*, where he contrasts the "free state" the Constitution creates with the "several kingdoms of Europe [where] ... the governments are afraid to trust the people with arms."

The Second Amendment, in other words, is not just a justification for the hobby of gun collecting. It is fundamental to the very nature of the American form of government, because, as Mr. Van

Alstyne writes, it "looks to an ultimate reliance on the common citizen who has a right to keep and bear arms rather than only to some standing army, or only to some other politically separated, defined, and detached armed cadre, as an essential source of security of a free state."

Of course, it is precisely an unfree state, a state secured by nationalized law enforcement administered by the BATF, FBI, DEA and the eleventy zillion other federal police forces, that the gun gestapo wants to build, and one reason it wants to get rid of privately owned guns is precisely because it and the elite it represents fear, distrust and despise the common citizens who will be the first victims of the unfree state that twinkles in their mind's eye.

The real battle in the courts for gun rights hasn't even begun yet, but what Mr. Van Alstyne makes clear is that that battle really isn't about guns. It's about the very substance of the constitutional republicanism that our form of government is supposed to guarantee, and if the wrong side wins that battle, gun owners won't be the only losers. Mr. Van Alstyne's article comes out of the kind of *honest liberalism* that could help the right side win, even after elected lawmakers have helped betray the rights they were supposed to guard. ✕

Reprinted with permission from *The Washington Times*.

### **"The Second Amendment ... is fundamental to the very nature of the American form of government ..."**

cases, there is virtually no case law from the Supreme Court on what the amendment's language means, and therefore there's no telling how the Nameless Nine would take it into their noggins to rule if a gun owner's rights case came before them. The court's propensity in the past simply to invent new rights and erase old ones is not encouraging.

But if there's little case law on the Second Amendment, there is an impressive body of recent scholarship that justifies the gun owners' view of the amendment. One in-

Amendment and the Personal Right to Arms" that "the essential claim ... advanced by the NRA with respect to the Second Amendment is extremely strong," therefore ought to be pretty compelling to liberals who share his intellectual honesty.

What's especially interesting in his argument is his emphasis on the phrasing of the Second Amendment in its first clause: "a well-regulated militia, being necessary to the security of a free State." The framers of the amendment were not talking about just any state but a "free state," and

# Venom™



**THE MOST POWERFUL...THE MOST POTENT...THE MOST EFFECTIVE DEFENSE SPRAY AVAILABLE!!!** We're serious about your safety, and nowhere is that more evident than in our line of Chemical Defense Spray VENOM. VENOM was developed to provide you with the highest degree of non-lethal protection available. VENOM is formulated to give optimum performance from each size unit. VENOM is fast acting and hard hitting, and is effective against even drunks, drug abusers, and psychotics.

- 3 Ounce Home/Auto Unit (Maxi-Blast top).....\$24.95
- 3/4 Ounce Pocket/Purse Unit.....\$11.95
- 3/4 Ounce Keyring Unit.....\$15.95  
(PLUS \$3.50 Shipping)

## THE WORLDS FINEST SLIM JIM

Our premium quality car jimmy tool is made of high quality spring steel, with rounded edges and textured black rubber handle. Comes with instructions.

SJ100.....\$9.95  
(PLUS \$3.50 Shipping)

## COBRA III+ ELECTRONIC LOCK PICK

"OPENS 99% OF ALL PIN TUMBLER LOCKS IN 7 SECONDS OR LESS"

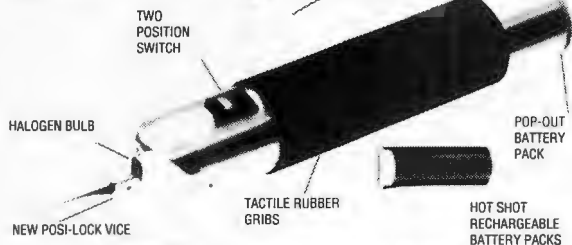

It's a technological dream come true! Finally, there's a fast way to pick open 99% of all pin tumbler locks in use today. All components are manufactured from aerospace aluminum alloys for a lifetime of quality, hassle-free service. The new Cobra III+ is jam-packed with all new features. Our exclusive high-intensity focused halogen key way light source; new tactile rubber grip; extra rechargeable "Hot Packs". The Cobra III+ is shipped complete with rechargeable Hot Pack wall charger, extra picks, tension tools, allen wrench, and shipping case.

Cobra III+.....\$499.00  
Comes complete in die cut shipping case (PLUS \$10.00 Shipping)

For our Florida customers, and our friends in law enforcement and military - write or call for a listing of our automatic collector's knives.

CLASSIC ITALIAN

INTERNATIONAL COMBAT SWITCH

THE SPIKE

Navy Seals II



**MAXIMUM SHIPPING CHARGE PER ORDER - \$10.00**  
**CHECK, MONEY ORDER, VISA, OR MASTERCARD**  
Full Line Catalog \$2.00



**WARNING: Check State & Local laws regarding use & lawful possession of items above. Must be 18 years or older to order.**

## D100 SAP GLOVES



Made of soft, pliable deerskin, these gloves have 6 ounces of powdered lead inserted across the knuckles of each fist. Discreetly effective.

D100.....\$69.95  
D-50 (Cowhide).....\$37.95  
(PLUS \$4.50 Shipping)

## LEATHER SLAPPER

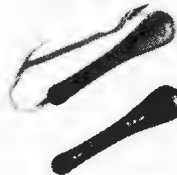

The highest quality slappers available. Constructed of smooth top grain cowhide with a leaded striking end. Available with or without a wrist loop. Made in U.S.A.  
BBS20.....\$19.95  
BBS21 (With wrist loop).....\$19.95  
(PLUS \$3.50 Shipping)

## POCKET PROTECTOR

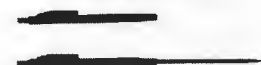

Press the pocket clip and a 4 1/2 inch long, 1/4 diameter spike extends from the body of the device, providing 10 1/2 inches of potent protection. Rugged, all steel construction.

GFR.....\$55.00  
(PLUS \$4.50 Shipping)

## BRASS KNUCKLES PAPERWEIGHT

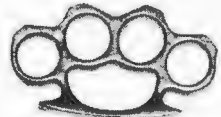

The finest product of its kind available—add a beautiful example of the metal worker's art to your collection.

KNB.....\$13.50 ea  
\$24.50 pr  
KNA Lightweight Aluminum.....\$8.00 ea  
(PLUS \$3.50 Shipping)

## Z-FORCE STUN GUNS



Z-FORCE stun devices are the best we've found! They offer reliability, high sustained voltage output and concealability - these devices are compact and powerful.

ZF-3, 100,000 Volts.....\$44.95  
ZF-4, 120,000 Volts.....\$69.95  
ZF-Ultra, 150,000 Volts.....\$99.95  
SouthOrd Security +, 200,000 Volts.....\$119.95  
(PLUS \$5.50 Shipping)

## "ACE PICK" TUBULAR LOCK PICK



Opens vending machines, T-top locks, washing machines, etc. This precision tool is made of HIGH QUALITY, HEAT TREATED STEEL, and picks tubular locks with mushroom pins. Includes a decoder and is available for center or offset locks.

APC 7 (7-PIN).....\$89.95  
APC 8 (8-PIN).....\$89.95  
BOTH PICKS.....\$159.95  
(PLUS \$5.50 Shipping)



## BLACKJACK

These law enforcement weapons, once the standard of police officers throughout the country, are finely crafted from lead, steel spring, and leather. Eight ounces of nostalgic protection. Made in U.S.A.

BJK8.....\$19.95  
(PLUS \$3.50 Shipping)

## PXS 14 LOCKPICK SET



(PXS 17 PICTURED)

This 14 piece set includes everything you need to open most locks and doors—an assortment of picks and rakes, two tension wrenches, a broken key extractor, and cowhide pocket case. Includes the book, Easy Pickins.

PXS14.....\$32.95  
PXS17.....\$49.95  
(PLUS \$3.50 Shipping)

# SOUTHERN ORDNANCE

"The hardest hitting products in the personal defense industry"

P.O. BOX 279 • DEPT. SF • Babson Park, Florida 33827

FAX (813) 638-2486 • (813) 638-2499



**NO POSTAGE  
NECESSARY  
IF MAILED  
IN THE  
UNITED STATES**

**BUSINESS REPLY MAIL**  
FIRST CLASS MAIL      PERMIT NO. 8      MT. MORRIS, IL

POSTAGE WILL BE PAID BY ADDRESSEE

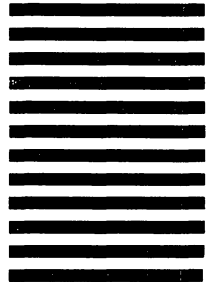

**SOLDIER OF  
FORTUNE**

PO BOX 348  
MT MORRIS IL 61054-9817



# THE SURE-FIRE WAY TO GREATER ACCURACY

**ADCO MIRAGE™** Sights feature advanced reflex sight technology and top quality mil-spec workmanship. They all have no focus, parallax-free sighting for fast target acquisition and click setting for easy windage and elevation adjustments. These rugged and reliable sights are available in Black or Nickel Finish. (All models)

## The MIRAGE RANGER

30mm diam. Red-Dot Sight is ideal for action shooters. It offers the same quality as reflex sights costing twice as much. The 30mm model has a large (10 M.O.A. \*) display. The economically priced 1" diam. Red-Dot Sight (not shown) is perfect for the sports shooter on a budget. It has a small (4 M.O.A. \*) dot.

## The MIRAGE SPORTSMAN

1" diam. sight with patented Multi-Color (Red-Green) Dot System can add an extra hour of quality hunting time to the day. It has a small (4 M.O.A. \*) display. The subdued Green Dot is ideal for early morning, in the evening, in heavy cover or under overcast skies.

## The MIRAGE COMPETITOR

30mm diam. sight assures a clear round (10 M.O.A. \*) dot. The patented Multi-Colored Dot System is the reason. If Red is not providing a clear dot because of lighting conditions, just switch the diode to Green. Ideal for indoor ranges or when any light situation makes Red a poor option. The ability to change the dot without the need of sighting in again could mean the difference between being "Champion" instead of runner-up.



RANGER



SPORTSMAN



COMPETITOR



10 Cedar Street  
Woburn, MA 01801

(617) 935-1799

Contact your local dealer  
or distributor for further  
information.

\*M.O.A. stands for Minute of Angle.  
1 M.O.A. covers 1 inch at 100 yards.