

Assault Weapons Ban — Lawmaking Based On Lies

**EXPANDED 19th  
ANNIVERSARY ISSUE!**

# SOLDIER OF FORTUNE

***Clear And  
Present Danger***

**LAW-ENFORCEMENT  
ABOVE THE LAW:  
7 Cases Of Blatant  
Abuse Of Power**

**WHO LASTS WINS:  
Grueling SAS  
Selection Course**

**WEAPONS CACHING —  
The Final Option**

**JUSTICE PERVERTED:  
Waco Judge Throws  
Out Jury Verdict —  
Hands Down Maximum Sentences**

**Farewell Chargin'  
Charlie Beckwith**

OCTOBER 1994  
# 48493



CAN. \$5.75 UK £2.60 U.S. \$4.95

PASTE FLAP HERE

**BUSINESS REPLY MAIL**

FIRST-CLASS MAIL

PERMIT NO. 8

MT. MORRIS, IL

POSTAGE WILL BE PAID BY ADDRESSEE

NO POSTAGE  
NECESSARY  
IF MAILED  
IN THE  
UNITED STATES



**SOLDIER OF  
FORTUNE**

PO BOX 348

MT MORRIS IL 61054-9984



***SOLDIER OF FORTUNE***



 **19TH** 

**ANNIVERSARY**

Passport to Adventure

*Sweepstakes*

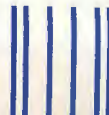

# EXTRAORDINARY SURVEILLANCE AND INVESTIGATION AIDS



## CONGRATULATIONS!

You've just found the best source for night vision scopes in the, well, hell, maybe the world.

The *American made SCOUT* is a compact, rugged, handheld viewer—the smallest unit of its kind in the entire world. Utilizing 3rd generation technology, the **SCOUT** works like magic in adverse weather and moonless nights. The intensifier tube and optics are identical to that of the Anvis Aviator's Goggles (remember Desert Storm?). The **SCOUT** takes common C-mount camera lenses, allowing almost any front-end configuration, (comes with 1X lens), including relays, doublers, and zooms.

Radical (optional) ocular relay allows direct operation with SLR and video cameras. Flip it around and *couple it to a rifle scope* or other device. Optional adapter allows use as single eye goggle. Even has a built-in IR illuminator and threaded rings on both ends...

Optional Weaver scope mount, or an invisible laser that throws an IR dot on your target that you can see and aim through the **SCOUT**.

We've spent a year testing scopes. The **SCOUT** is the best price/best scope/best deal we've found. Packed in a hard-shell foam lined case, all units come with a one year warranty (covers the tube).

- 2nd generation reconditioned \$1495
- 2nd generation new \$2450
- 3rd generation new (4 times as powerful, 4 times the tube life!) Only \$2995! Usually priced at about \$6,000, this is the hottest unit on the market. (No credit card orders on scopes.)



## COUNTER SURVEILLANCE

**C3** This is the first (patented) unit that has ever, I mean ever, been able to find government, police, industrial spy, and top private detective taps on any phone line, from your phone through the phone company *Central Office!*

Finds slaves, bridges, loop extenders. Stuff *nobody* has ever before been able to prove lives on your line. C3 covers one phone line, and guarantees your on-going protection from these taps \$595.

**ATS** Automatic Tap Stopper. Stays on the line, defeats all X-phones, infinity transmitters, automatic recorder starters, parallel transmitters, many series transmitters. Peace of mind for \$495 Spy shops charge \$1,000 for similar units... And ours is better.



## COBRA III+ ELECTRONIC LOCK PICK LAST CHANCE EVER AT THIS PRICE!

Manufacturer is going to raise the price to \$499 on Nov. 15, 1994. Until then, send us your \$399 and get the deal of the century!

**Open 90%+ of all the locks in the world in 30 seconds or less!**

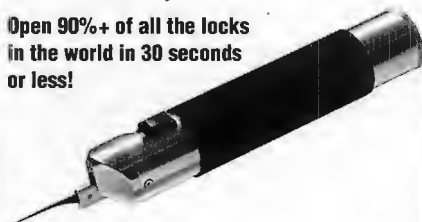

The COBRA III+ is made by the inventor of electronic lock picks. Magic, it's just magic. Rechargeable hot packs, Halogen key-way light, aircraft aluminum construction, thin picks, very powerful motor, rubber grips. The California state lock picking champion did 20 locks in 3-7 seconds each—on camera. **Buy a COBRA, mention this ad, and get our \$59.95 Video Tape "Superpicking" for half price!**

Automatic, computerized garage door openers! This is not a joke, picture a little black box that will open 99% of all auto garage doors in the US in 30 seconds to 2 minutes. Great for SWAT teams, or replacing lost openers. *Not sold for illegal entry!* \$329.

A Professional ELECTRONIC TRACKERS, \$3,000. SOLD BY OTHER DEALERS FOR \$6K! The best telephone recorder starter EVER ("The Mother") \$75.

Best books, newest videos, hottest equipment... our new catalog \$10—free with any purchase. Credit card orders MUST be phoned in to 1-800-805-5544. *Nice order takers have no other information.* If you have a specific question, please FAX us at 415-851-5403 or write via a government agency—the postal service.

**CHECK OR MONEY ORDER TO:  
INTELLIGENCE INCORPORATED  
2228 S EL CAMINO, #349D  
SAN MATEO, CA 94403**

+ \$5 shipping. CA residents include 8% tax.  
(Checks held for clearance.)

**ORDERS ONLY:  
1-800-805-5544**

(Nice order takers but they have no other information.)  
Visa and MasterCard accepted.

**INTELLIGENCE  
INCORPORATED**

## MAGAZINE STAFF

**Editor/Publisher** ..... Robert K. Brown  
**Associate Publisher** ..... T. (Lefty) Wilson  
**Executive Editor** ..... Tom Slizewski  
**Senior Editor** ..... Don McLean  
**Technical Editor** ..... Peter G. Kokalis  
**Features Editor** ..... Dwight Swift  
**Columns Editor** ..... Lynne Robertson  
**Production Director** ..... Kathleen Allard  
**Art Director** ..... Mary Scrimgeour Jenkins  
**Assistant Art Director** ..... Kristine Anderson

## Foreign Correspondents

Chief Foreign Correspondent: Dr. Tom Marks  
Senior Foreign Correspondents:  
Steve Salisbury • Rob Krott • Peter Douglas •  
Chuck Fremont • Morgan Tanner •  
Jack Thompson • Maj. Mike Williams •  
Mike Winchester • Dale B. Cooper

## Contributing Editors

*Vietnam Veterans Affairs* Col. Chuck Allen •  
*Military History* William Brooks — William H. Northacker • *Unconventional Operations* Brig. Gen. Heine Aderholt — James P. Monaghan — Maj. Robert MacKenzie • *Military Affairs* Alexander McColl • *Paramedic Operations* Dr. John Peters • *Explosives/Demolitions* John Donovan • *Aviation* Dana Drenkowski • *Africa* Al Venter • *Outdoor Affairs* Galen Geer • *Latin America* Hugo Hartenstein • *Gun Rights* Paul Danish • *Skydiving* Kitty Baran

**Financial Director** ..... Gregg Peterson  
**Business Manager** ..... Sharon Windsor  
**Bookkeeper/ Classified Advertising** .... Carole Hayden  
**Circulation Manager** ..... Carrie Karlson  
**Consultant** ..... Zada Johnson  
**Advertising Manager/Assistant Convention Director** ..... Dianne McLeod  
**Receptionist** ..... Helena Oberg

For editorial/advertising, call 303-449-3750.  
Subscription inquiries, call 1-800-877-5207.  
For list rental contact: Dave Power, Antigone Associates 215-357-9267.

## In Memoriam

Craig Nunn — Art Director  
Lance Motley — Foreign Correspondent  
Barry Sadler — Contributing Editor

NOTICE: SOLDIER OF FORTUNE Magazine is a magazine of national and international distribution. There may be products in the magazine of which sale, possession or interstate transportation may be restricted, prohibited or subject to special licensing requirements in your state. Purchasers should consult local law enforcement authorities in their area. All data in this publication, technical or otherwise, is based upon personal experience or individuals using specific tools, products, equipment and components under particular conditions and circumstances, some of which may not be reported in the article and which Soldier Of Fortune has not otherwise verified. Soldier Of Fortune, its agents, officers and employees disclaim any responsibility for all liability, injuries or damages.

## Remember In November by Robert K. Brown

Our worst fears were realized when the American people had the Crime Bill, including the Feinstein Amendment, shoved up their collective ass by the traitors from that cesspool known as Capitol Hill. Obviously, the NRA et al. no longer have the clout to stop even misguided, anticonstitutional antigun legislation inside the Beltway.

It reaffirms my longstanding belief that the only thing the whores on the Hill care about is maneuvering to get enough votes for reelection. Our only chance of keeping our Second Amendment rights is to vote on 8 November and show the traitors, scumbags and charlatans they made a bad move. This way we'll teach incumbents and newly elected members of Congress that if they cross gun owners, their time feeding at the public trough will be sharply curtailed.

This election is our best chance to get our point across. Our commander in chief, (God, even writing that makes me puke!) a draft-dodging, dope-smoking, dull-eyed slug, has so alienated significant elements of the electorate, including Democrats, that projections indicate there will be a low voter turnout. This will give our votes more impact than normal. If each of us also strong-armed or otherwise persuaded two buddies to register and vote, our victory would be all but certain.

The Republicans need to win 40 seats in the House and eight of the 34 Senate seats to take outright con-

trol of both Houses. Even if the Republicans do not win the House, by winning 25 seats they could exert effective control with a loose coalition of conservative Democrats.

Many are fearful that government, in desperation, will manufacture some incident that puts gun owners in a bad light prior to this year's election. The current government is not beyond staging some stunt that will deflect people's attention from its general failure to govern and justify a confiscation or more Draconian restrictions on certain types of firearms. If it happens, see it for

what it is and don't let it sway you from the righteousness of our cause.

As an aside, dissatisfaction with the Biliary Administration has become increasingly widespread among the military, to the point where a publication titled *The Resister, The Official Publication of the Special Forces Underground*, has emerged. To obtain a copy, send a No. 10 SASE to SOF, Box 693, Boulder, CO 80306. Our making this available is by no means an endorsement of *The Resister* or its contents but serves to illustrate the growing dissatisfaction that all of us who care about the Constitution and the United States must tap into if we are going to turn around the state of the nation.

So, register two buddies, then vote! We're all in this together, but you have only yourself to blame when the ATF Gestapo comes knocking on your door for your guns. ✕



SOLDIER OF FORTUNE (USPS 525-810, ISSN 0145-6784) is published monthly by SOLDIER OF FORTUNE Inc., 5735 Arapahoe Ave., Boulder CO 80303-1340. Second-Class Postage is paid at Boulder CO and additional mailing offices. POSTMASTER: Send address changes to SOLDIER OF FORTUNE, Subscription Department, POB 348, MT Morris IL 61054-0348 or call 1-800-877-5207. U.S. and APO-FPO subscription rate for twelve monthly issues: \$28.00. Canada add \$10.00/yr. additional postage (includes GST tax registration number: R128476249). All other countries add \$21.00 U.S. FUNDS ONLY. Single Issue Price — U.S., \$3.95; United Kingdom, £2.60; Canada, \$4.75. PRINTED IN THE U.S.A.

CONTRIBUTORS: Manuscripts, photographs or drawings are submitted at the contributor's own risk. Material should be mailed to Articles Editor, SOLDIER OF FORTUNE, P.O. Box 693, Boulder, CO 80306, and cannot be returned unless accompanied by sufficient postage. Any material accepted is subject to such revision as is necessary to meet the editorial requirements of SOF. All manuscripts must be typed double-spaced. All photographs should be credited and be accurately identified. Payment will be made at rates current at time of publication. Editorial office phone number is 303-449-3750.

Copyright © 1994 by SOLDIER OF FORTUNE Magazine Inc. All Rights Reserved.

# SOF

VOL. 19 NO. 10  
October 1994



Paying for Peace — page 62

Photo: Richard Emblin

## FEATURES

### DONOVANS AIRBORNE ALL THE WAY

**SOF Staff**

Another family member earns his wings and joins Donovan airborne dynasty. 31

### SELLING OUT THE CONSTITUTION

**Dwight Swift**

Badly misinformed or deviously dishonest? Congresspersons tell why they elected to corrupt the Second Amendment and voted for the Assault Weapons Ban. 32

### WACO: JUSTICE TAKES A HOLIDAY

**Dick J. Reavis**

Judge ignores jury verdict, makes up facts and hands down maximum sentences. 36

### "THEY CAN SHOOT YOU, BUT THEY CAN'T EAT YOU"

**Col. Mike Peck**

Wildcat A-Team does unto Charlie what Charlie planned to do unto them during '65 Christmas "truce." 40

### EDITOR'S PICKS FOR RIGHTEOUS READING

**SOF Staff**

We waded through the literary mud to find a dozen books that really deliver. 46

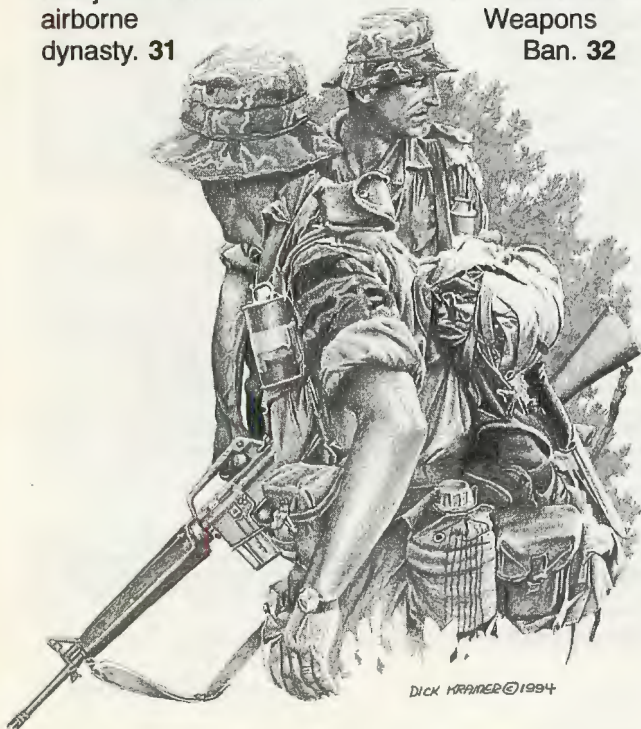

### CLEAR AND PRESENT DANGER

**Dan Gagliasso**

Big-budget Clancy thriller tries to get it right by hiring active duty Special Forces trainers to school its actors in the way of the sniper. 48

### RUGER/LEUPOLD COUNTERSNIPER

**Peter G. Kokalis**

Precision, performance and value in a professional sniper system costing under \$1,200? 50

### WHO LASTS WINS

**Todd Cole**

There is a hell on earth, and if you want to serve among the super elite Australian SAS, you'll get a close-up look at what it's like. 54



Who Lasts Wins — page 54

Photo: Yves Debay



## COLUMNS

### Bulletin Board 6

Sarah Brady's Dream Come True

### FLAK 10

What's That Smell?

### I Was There 15

Adventures of Ranger Rick

### World SitRep 16

### Slick Willie Watch 20

Pay Off The National Debt?

### Adventure Quartermaster 25

Plenty Of Power

### Full Auto 29

Can-Do Cannon

### Advertisers Index 84

### Supply Locker 88

### Classified 93

### Parting Shot 98

Notice To All Politicians

Chargin' Charlie — page 65

Photo: Joe Galloway

### LAW ENFORCEMENT ABOVE THE LAW?

**James L. Pate**

Institutionalized arrogance increasingly has cops choosing confrontation over common sense, and innocents are paying the price. **58**

### PAYING FOR PEACE

**Richard Emblin**

Is bribing bandits a solution to terrorism? Colombian government asks insurgents to lay down arms and pick up checks. **62**

### FAREWELL CHARGIN' CHARLIE

**Col. Mike Peck**

*SOF* mourns the passing of a real hero and founder of America's most elite fighting unit — Delta Force. **65**

### GARDENING AT NIGHT

**Dutch Hillenberg**

When you run out of options, a little dug-in defense could keep you and yours safe. **66**

## COVER

Hollywood turned

to active duty

SpecOps opera-

tors to train the

sniper team

assigned

to hunt down

and terminate

Colombian

druggies in the

film version of

Tom Clancy's

hit novel *Clear And Present*

*Danger*. Ben Bratt, who plays

team leader Capt. Ramirez, is armed with

M16/M203. Article on page 48.

Photo: Bruce McBroom



# BULLETIN BOARD



SOF contributor James L. Pate delivers keynote address at annual Gun Owners of New Hampshire banquet in May. Pate, whose coverage of constitutional abuses by the BATF has drawn nationwide attention, discussed Waco and its aftermath, and what its implications hold for the future of law-abiding gun owners. His one-hour talk is available on video from Craig Peterson of GONH; phone: 603-672-8332. Photo: Craig Peterson

## GULF WAR SYNDROME

The DoD has established a toll-free hotline as a point of contact for veterans of the Gulf War who may have symptoms of Gulf War Syndrome, or may wish to participate in ongoing medical studies of troops who served there. The call is free, as is any service they would provide to Gulf War vets. If you were there and think you may have a problem, they want to help; call 800-796-9699.

## ORGANIZED MILITIAS

Going one up on the Georgia town that passed an ordinance requiring homeowners to be armed, three counties in the Florida panhandle, with a combined population of more than half a million, have enacted county ordi-

nances establishing a militia and making every able-bodied man, woman and child a member. Since the measure was passed unanimously by the Santa Rosa County Commission, virtually identical ordinances have been passed by Escambia and Okaloosa counties. Noted H. Byrd Mapoles, author of the Santa Rosa ordinance, "Most

folks in this part of the country are not willing to give up their guns ... We in northwest Florida believe that we have certain rights given us by the United States Constitution ... We want those folks in Washington and Tallahassee to recognize those rights and not take them away from us." Uncertain of how the current federal onslaught on the Second Amendment may turn out, officials in Escambia County are also considering establishing a standing *posse comitatus*, an armed sheriff's auxiliary open to interested county residents.

## CASTING STONES

Americans, at least those whose memories aren't permanently scalded by the Bataan Death March or the Rape of Nanking, tend to think of the Japa-

nese as a very law-abiding society. So when they hand *our* president a petition asking Americans to turn in their private weapons, some Americans at least, think maybe these folks can give good advice, since they're so law-abiding themselves. Oh really?

Well, now let's see. Discounting street punks and low-level gangs and getting right to *professional* criminals here's some interesting figures: The United States has one Mafia organized crime member for each 2,022 square miles; Italy has one Mafia organized crime member for each 7.6 square miles; Japan enjoys one Yakuza organized crime member for each 1.5 square miles. Since Japan has a high population/land ratio, maybe it'd be fairer to do it by population: one in 144,287 Americans is a gangster; one in 3,851 Italians is a gangster — and one in 1,240 Japanese is a gangster. Source: *Public Intelligence Review and Newsletter*, 3808 Rosecrans St. Suite 442, San Diego, CA 92110. (This new publication bills itself as a "combination inoculation and booster-shot against media

disinformation." It truly is. We read it and recommend it.)

## NO GOVERNMENT GROUND FOR CANADIAN MEMORIAL

Maybe they're disgruntled because we got the best of the bargain (when we got their 40,000 volunteers and all they got was 20,000 draft dodgers and 12,000 deserters), but the Canadian government has declined to provide government land for a \$100,000 memorial donated by the Michigan Association of Concerned Veterans. It's a tribute to their Canadian comrades,



SOF Columns Editor Lynne Robertson bonds with Benelli Super 90 under careful tutelage of Tactical Firearms Training Team's (TFTT) Alan Roy near Lake Euisnore, California. In addition to defensive shotgun, TFTT offers instruction in all levels of combat handgunning, rifle, night shooting, VIP protection, fieldcraft and personal defense, plus specialty police courses. A new combat handgun video by director Max Joseph delivers expert, no-bull instruction, geared to develop speed and tactically useful defensive shooting skills: well worth the \$49.95. For further info or to order, contact TFTT, Dept. SOF, 16835 Algonquin St., Suite 120, Huntington Beach, CA 92649; phone: 714-846-8065. Photo: Max Joseph

## THE LONG-RANGE WAR Sniping in Vietnam by Peter R. Senich

The Vietnam War marked the first time that the U.S. military brought together trained snipers, special rifles and ammunition, telescopic sights and noise suppressors and employed them successfully in a combat environment. The overall effort – including both official and “independent” sniping operations – proved extremely effective in countering the tactics and activities of the Vietcong, who were not the least bit intimidated by ordinary rifle fire. This book is the most complete report ever published on this small but very significant aspect of modern military history. Focusing primarily on the Army sniper program, it covers the circumstances behind the fielding of the sophisticated XM21 sniper rifle and the Adjustable Ranging Telescope (ART), as well as the use of sound suppressors for rifles and special carbines, which was so characteristic of the unconventional nature of the warfare in Southeast Asia. 8 1/2 x 11, hardcover, photos, illus., 280 pp. **\$39.95**



**ADVANCED MASTER HANDGUNNING**  
Secrets and Surefire Techniques to Make You a Winner  
by Charles Stephens  
Champion shooter Charles Stephens reveals the advanced secrets behind superaccurate shooting of still, moving and long-range targets. His unique self-teaching methods will help you improve your stance, mechanics, follow-through and mind-set to nail the bull's-eye every time! 5 1/2 x 8 1/2, softcover, photos, 72 pp. **\$10.00**

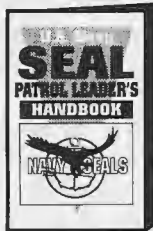

**U.S. NAVY SEAL PATROL LEADER'S HANDBOOK**  
Here is the authentic manual used by the U.S. Navy to train the patrol leaders of its elite SEAL teams. An inside look at the mission planning process, target analysis, rules of engagement, warning order and patrol leader's order, insertion and extraction methods, E & E procedures and more. Plus, appendices on intelligence, weaponry and demolitions, vessels, aircraft and communications. 5 1/2 x 8 1/2, softcover, illus., 160 pp. **\$15.00**



**PRO SNIPER**  
An Inside Look at Today's Top Military and Police Snipers  
Learn the difference between the vital jobs of elite military and police snipers through this inside look at how they train and operate. SEAL, SWAT and other top snipers reveal their tricks, display their special gear and discuss the unique traits of their tactical assignments. You'll see action footage of a modern sniper competition between the best sniper teams in the country. Color, approx. 30 min., VHS only. **\$29.95**



**BOOK II - HOW TO GET ANYTHING ON ANYBODY**  
The Encyclopedia of Personal Surveillance  
by Lee Lapin  
This long-awaited follow-up to the best-selling first volume is a gold mine of the latest techniques and tricks of intelligence collection. Learn how to bypass computer passwords, look or listen through solid walls, gather personal data on anyone and much more! 8 1/2 x 11, softcover, photos, illus., 232 pp. **\$35.00**

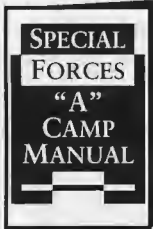

**SPECIAL FORCES "A" CAMP MANUAL**  
Now, more than ever, Special Forces is the front-line defense of strategic U.S. interests around the world. This official manual fills in the gaps that exist in SF doctrine and teachings in the areas of planning, constructing and maintaining an "A" Camp. It reflects "real-world" experiences of notable SF veterans regarding site selection, weapons placement, communications, motor pools, perimeter protection, etc. 8 1/2 x 11, softcover, illus., 280 pp. **\$25.00**



**HARDCORE HAYDUKE**  
More Down-and-Dirty Revenge Techniques  
by George Hayduke  
Just when you thought bullies were once again getting the upper hand in this mean old world, George Hayduke and his legions of fans return with more clever, devious and downright nasty tricks, pranks and campaigns to turn "marks" into sniveling fear freaks! For entertainment purposes only! 5 1/2 x 8 1/2, hardcover, 240 pp. **\$19.95**



**CREDIT SECRETS**  
How to Erase Bad Credit  
by Bob Hammond  
Solve your financial problems once and for all! These proven methods show how to eliminate debts and establish a perfect credit rating. Discover the inside tricks used by lawyers and professional credit consultants with this easy-to-follow program. 5 1/2 x 8 1/2, softcover, 80 pp. **\$14.00**



**THE GREEN BERETS**  
The Real Story Behind the U.S. Special Forces  
Here is the reality behind the legend from Special Forces vet and best-selling author Jim Morris. Three generations of this brotherhood of highly trained, dedicated and motivated elite soldiers present a captivating oral history of their operations. Rare footage of their daring missions deep in enemy territory provides the colorful backdrop. Color, approx. 50 min., VHS only. **\$29.95**

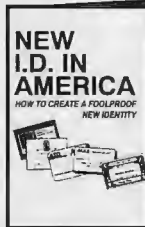

**NEW I.D. IN AMERICA**  
by Ed Carson  
Want one more chance at life with a "clean slate"? Trade in your old identity for a new start. Here is a step-by-step guide to creating a totally new you – with a birth certificate, passport, driver's license, Social Security number – all you need for breaking with your past. 5 1/2 x 8 1/2, softcover, illus., 120 pp. **\$17.00**



**NAVY SEALs**  
America's Secret Warriors  
Here is an all-new inside look at the toughest warriors alive. Through exclusive footage, you will see Navy SEALs in action in Vietnam, Grenada, Panama and Kuwait. Actual Vietnam patrols, prisoner snatches, combat jumps and beach infiltrations are just some of the secret missions you'll witness. Also includes new footage of BUDs training and modern SEALs undergoing combat training. Color, approx. 50 min., VHS only. **\$24.95**

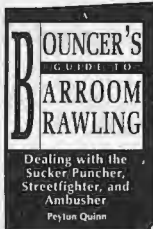

**A BOUNCER'S GUIDE TO BARROOM BRAWLING**  
Dealing with the Sucker Puncher, Streetfighter, and Ambusher  
by Peyton Quinn  
As a bouncer in a biker bar and a participant in dozens of fights, Peyton Quinn knows the difference between fighting fact and fantasy. The result is a unique guide to self-defense that can save your ass in places where brawling is quick, dirty and very violent. 5 1/2 x 8 1/2, softcover, photos, illus., 264 pp. **\$17.95**

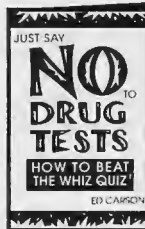

**JUST SAY NO TO DRUG TESTS**  
How to Beat the Whiz Quiz  
by Ed Carson  
Urinalysis is a blatant violation of human freedom and dignity, and now you can fight back! Ed Carson, who handled drug testing for a large U.S. military base, reveals how the tests are done and how to beat them. He did it successfully for eight years using the exact methods outlined in this book. Find out how to preserve your life-style and keep your job. 5 1/2 x 8 1/2, softcover, 48 pp. **\$12.00**

### OTHER FASCINATING TITLES

THE SLING FOR SPORT AND SURVIVAL.....\$ 7.95  
GET EVEN 2: MORE DIRTY TRICKS FROM THE MASTER OF REVENGE.....\$19.95  
U.S. MARINE CORPS SNIPING.....\$14.95  
AK47: THE COMPLETE KALASHNIKOV FAMILY OF ASSAULT RIFLES.....\$14.00  
PRIVACY: HOW TO GET IT. HOW TO ENJOY IT.....\$18.95  
REBORN IN THE U.S.A.....\$14.95  
STREET E & E.....\$16.00  
HOW TO HIDE ANYTHING.....\$12.00

KGB ALPHA TEAM TRAINING MANUAL.....\$20.00  
U.S. ARMY SPECIAL FORCES MEDICAL HANDBOOK.....\$22.95  
101 SUCKER PUNCHES.....\$10.00  
SAFE IN THE CITY.....\$21.95  
USING OFFSHORE HAVENS FOR PRIVACY AND PROFITS.....\$15.00  
PATTERN-WELDED BLADE.....\$35.00  
MISSING PERSONS, USA...\$15.00  
WILDERNESS WAYFINDING...\$15.00  
CHEAP SHOTS, AMBUSHES AND OTHER LESSONS.....\$15.00  
SKS CARBINE.....\$14.95

#### MONEY-BACK GUARANTEE — DEALER INQUIRIES INVITED

Paladin Press • P.O. Box 1307 • Boulder, CO 80306 • (303)443-7250  
FAX (303)442-8741

Videotapes are nonreturnable. Damaged tapes will be replaced.



**PALADIN PRESS**  
P.O. BOX 1307-4JS  
BOULDER, CO 80306



**CREDIT CARD ORDERS CALL TOLL FREE**  
1-800-392-2400

Call 24 hours a day, 7 days a week. Send \$2.00 for a 64-page CATALOG of over 600 titles (free with order).

PLEASE SEND ME THE FOLLOWING TITLES:

RESPONSE CODE: 4JS

NAME \_\_\_\_\_  
ADDRESS \_\_\_\_\_  
CITY \_\_\_\_\_  
STATE \_\_\_\_\_ ZIP \_\_\_\_\_

VISA  MASTERCARD  
 DISCOVER  CHECK / MONEY ORDER

CARD# \_\_\_\_\_  
EXP. \_\_\_\_\_

NAME \_\_\_\_\_ SUBTOTAL \_\_\_\_\_  
ADDRESS \_\_\_\_\_  
CITY \_\_\_\_\_ PLEASE INCLUDE POSTAGE & HANDLING \$ 4.00  
STATE \_\_\_\_\_ ZIP \_\_\_\_\_ TOTAL \_\_\_\_\_



## SARAH BRADY'S DREAM COME TRUE

And then there are somewhat less organized militias: One Linda Thompson, Esq., has anointed herself "Acting Adjutant General, Unorganized Militia of the United States of America" and as such has ordered that "All militia units will convene at 8 a.m. [EST], [date]... in Washington, D.C., armed and in uniform, to deliver the Declaration of Independence to the White House and to enforce the ultimatum. The militia will arrest congressmen who have failed to uphold their oaths of office, who then will be tried for treason by citizens' courts."

Her "Alert!!" bulletin, a paraphrased version of the real Declaration of Independence, and petition forms, which Thompson has asked Americans to reprint and "fly planes to airdrop," contain a memo reading in part: "*Note: Militia members must wear identifying insignia and be armed. If you are armed and wear a military insignia identifying you as a member of a military unit, if captured you must be treated as a prisoner of war, not as a criminal arrestee,*

by law." Swell. Maybe you'd get a cell right next to Manuel Noriega.

This media circus would be just what the spin-doctors ordered: an armed mob of "typical gun owners and Second Amendment patriots" descending on the Capitol to kidnap legislators and try them in a kangaroo court. Noted Larry Pratt of *Gun Owners of America*, "There can hardly be an easier way for the government to find a provocation to either declare martial law or at a minimum to set the media loose on an unprecedented orgy of anti-gun hate that would throw every possible pro-gun race into a nose dive this November." Commented the Colorado Springs *Patriot News*, "Creating this kind of ill-conceived revolt will ... hurt the cause of all of us in opposition to government rights control. This will help the thieves of our rights make their case, and it will work against us. It is a sucker play." We concur: This battle will be lost or won with ballots. If it gets to bullets and lynchings, we've all lost the battle.

not unlike the Canadian memorial at Arlington National Cemetery for Americans who died fighting for Canada in World War II before the United States entered that war.

Of the estimated 12,000 Canadians who served in Vietnam with American troops, some 113 were KIA, and 7 are MIA and assumed dead. Canadian Vietnam vets are eligible for most U.S. GI benefits. Canadian companies sold the Pentagon \$2.5 billion of ammo, napalm, aircraft

engines and explosives; an additional \$10 billion was exported from Canada for the war effort as food, beverages, berets, boots, lead, copper, brass and oil. During the Vietnam War, Canada's unemployment fell to an all-time low of 3.9%.

Although there is a Canadian law from the Spanish-American War era forbidding Canadians to enlist in for-

eign armies, Canada chose to turn a blind eye to their citizens who enlisted for Vietnam. However, Canada did not officially take part in the war, and does not memorialize people who fought in a war in which it was not a participant.

Other Canadian Vietnam veterans groups have put up their own memorials on non-government land, as at Melocheville, Quebec. — *Jim Pate*

## MARINE ANGLICO

Any past or active Marine who served in Anglico — Vietnam or not, airborne or not — should know there is an Anglico Association and they are planning a reunion in Washington, D.C., next year: contact Jim Porta, Anglico Association, P.O. Box 27554, Tucson, AZ 85726.

## RIFT? READ THIS

The U.S. Army has given the Double Cola Co., Chattanooga, Tennessee, a \$5 million contract to help build a soda pop manufacturing plant on the grounds of Russian defense contractor NPO Mashinostroyenia at Reotov, Russia. L.E. Shanks, president of Double Cola, said in an

interview that the bottling plant will employ about 200 people and the product will be sold largely in the Moscow area. Well, that takes care of some of the defense contractors in the alleged Russian draw-down ... now how about some of *our own* contractors and/or troops?

## CHURCH GUNS TRADED FOR TAX BREAK

The Church Universal and Triumphant of Corwin Springs, Montana, has reached an accommodation with the IRS in which Uncle Sam will kiss off some \$2.6 million in back taxes and restore the Church's non-profit status in return for the church's agreeing not to own or store weapons, and dispose of its existing weapons within 90 days. The government, in earlier revoking the church's non-profit status, had accused the church of amassing military-style weapons, including semiautomatic rifles, armored personnel carriers and "thousands of rounds" of ammunition. The case piqued *SOF's* curiosity enough to do an article on the CUT late last year (see "ATF's Next Big Mistake?" Dec. '93). ✕

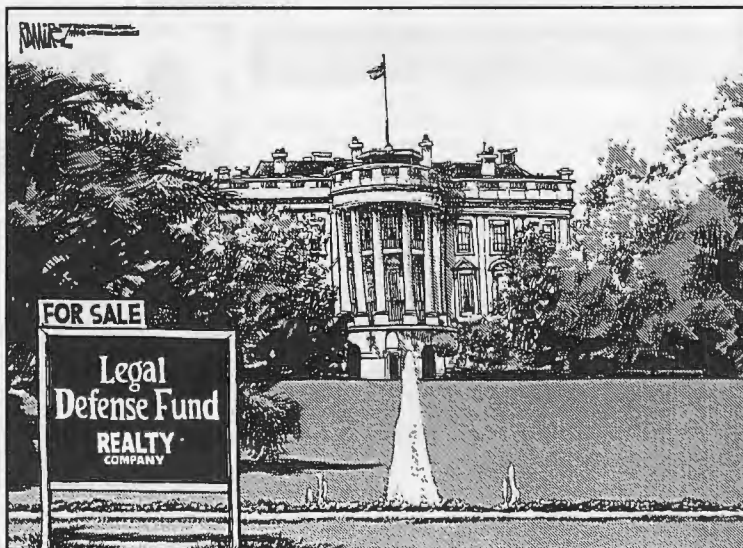

# GET A FIRM GRIP ON...

One sure-fire way gets you top-caliber books—authoritative works like *Pistols of the World*. Make sure you set your sights on **The Military Book Club®**.

7609+ \$18.95

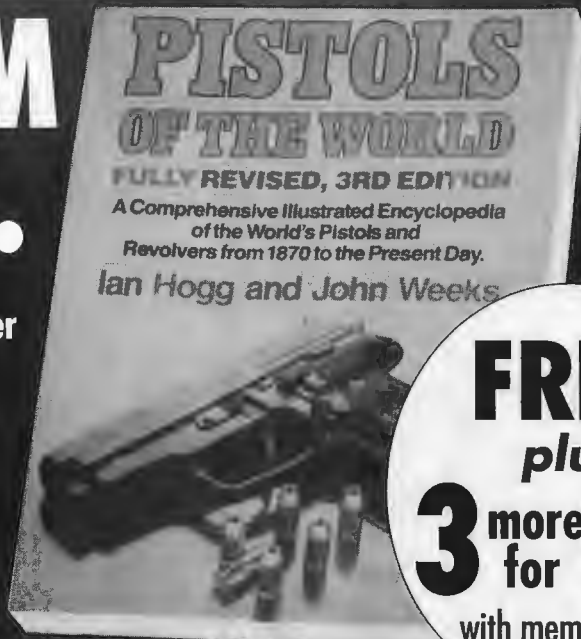

**FREE**  
plus  
**3 more for 98¢**  
with membership

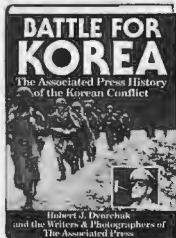

4168-9999\* \$34.95



1297+ \$17.95



4473++ \$29.95



4481 \$27.95



4671++ \$22.00



5256 \$19.95x

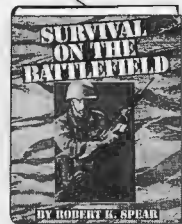

6791+ \$14.95

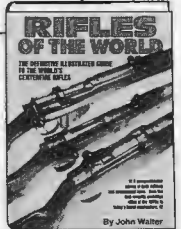

2915+ \$19.95



0018 \$24.00



4721 \$12.95x



3012 \$12.95x



0604 \$23.00



3434 \$24.95

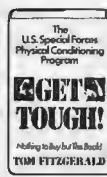

3988+ \$10.95



1289 \$18.95



2733+ \$19.95



5207+ \$50.00

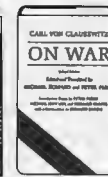

5652+ \$17.50

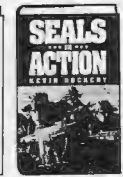

4069 \$14.95x



2949 \$22.00

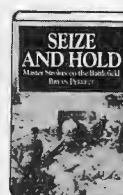

0398 \$24.95



3475 \$16.95x



0547 \$21.95



2568 \$22.00



2279 \$23.00

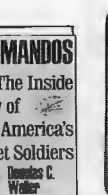

0182-9999\* \$29.95



3053 \$22.95



4259+ \$19.95



0232 \$29.95

## HERE'S WHAT YOU GET WHEN YOU JOIN...

**A GUARANTEE OF SATISFACTION.** Once your membership's accepted, we'll send the 3 BOOKS you've chosen plus *PISTOLS OF THE WORLD*. If you're not 100% satisfied with the 3 books, return them within 10 days at our expense. Membership will be canceled; you'll owe nothing. **THE FREE CLUB MAGAZINE.** You'll receive up to 16 issues a year. Each issue reviews the Featured Book Selection(s) plus a wide variety of alternate books from the Club's extensive library. **SHOPPING MADE SIMPLE.** To get the Featured Book Selection(s), do nothing—it will be sent automatically. If you prefer another book—or none at all—simply return your Member Reply Form by the specified date. A shipping and handling charge (and sales tax, where applicable) is added to each order. **HUGE DISCOUNTS ON HARDCOVER BOOKS.** Save as much as 30% off publishers' edition prices. Club books are sometimes altered in size to fit special presses. **AN EASY-TO-MEET OBLIGATION.** Take up to 2 years to buy 4 more books at regular low Club prices. Afterwards, you may resign membership anytime. **RISK-FREE RETURN PRIVILEGES.** If you get an unwanted book because your Club magazine was delayed and you had less than 10 days to respond, simply return the book at our expense.

Prices shown are for publishers' hardcover editions. Club hardcover editions save you up to 30%.

\* Counts as 2 choices x Special edition exclusively for Club members + Softcover ++ Fiction

## THE MILITARY BOOK CLUB®

Your #1 Source for Military Books

MAIL TO: The Military Book Club  
6550 East 30th Street  
P.O. Box 6357  
Indianapolis, IN  
46206-6357

**YES!** Please enroll me in *The Military Book Club* according to the risk-free membership plan described in this ad. Send me *PISTOLS OF THE WORLD FREE*, plus the 3 BOOKS I've indicated. Bill me just 98¢, plus shipping and handling.

**SAVE EVEN MORE!** Send me this book now and reduce my commitment to 3 books. Bill me an added \$3.99, plus shipping and handling. Books that count as 2 choices are not eligible.

Mr./Mrs. \_\_\_\_\_ (write book number)  
Miss/Ms. \_\_\_\_\_  
57263 90

Address \_\_\_\_\_ Apt. \_\_\_\_\_

City \_\_\_\_\_

State \_\_\_\_\_ Zip \_\_\_\_\_

Members accepted in U.S.A. and Canada only. Canadian members serviced from Canada, where offer is slightly different. Sales tax added where applicable. We reserve the right to reject any application. SOF 10/94

Please write book numbers here: If you already own the FREE book offered, you may substitute for it. Simply cross out the book #7609 and write in the number of the book you prefer.

FREE BOOK #7609

57264 91  
If you select a book that counts as 2 choices, write the first 4 digits of the book number in one row of boxes and 9999 in the next.

## JUST FOLLOWING OOHNDERS

Branch Davidian Clive Doyle forgivingly said of the ATF murderers, "They were just following orders" (*SOF* July '94). Though most of the ATF thugs are probably not old enough to remember, at the end of World War II we hung Gestapo goons whose only excuse for their atrocities was that they were "just following orders."

That was not an acceptable excuse then, and it should not be one today. Our ATF goons must be indicted and prosecuted to the full extent of the law. Likewise, those who gave the orders must be prosecuted all the way up the chain of command — at least to Janet Reno and preferably on to Bill Clinton.

Robert Paul Johnson  
Powell, Tennessee

## CAN'T SPELL AIR FORCE

I really enjoyed your story on the PJs in Somalia ("Fast-Rope Into Hell," *SOF* July '94). I did notice a lack of emphasis on which military branch they are members of. It was as if the author had a hard time spelling the words *Air Force*.

Less than 4% of Air Force personnel fly aircraft and the Air Force has some of the most highly trained special operators in the world.

Staff Sergeant C. P.  
United States Air Force

## WHAT'S THAT SMELL?

During my service in Spetsnaz (see photo), I used the suppressed PSS pistol mentioned in "Russia's Secret Weapons" (*SOF* July '94). My unit was issued the PSS in the late '80s as a replacement for the Makarov-based PB pistol. At this time we also used



the two-barrelled non-automatic pistols "Groza" and PMS (*Pistolet Malij Spetsialnij*).

Groza and MPS used suppressed ammunition featuring bullet diameters similar to the 7.62x39mm round but with different case sizes. Both these pistols had their ammo assembled in two-round clips. These rounds were packed in a white box with 12 rounds plus six clips in each box. One such round was recovered by *SOF* in El Salvador in 1990.

The PMS round was designated SP-1 and had one peculiar feature: Spent cartridge cases smelled like shit. Once I put spent cases in my rucksack and on the way

back from shooting, my friends thought I was farting the whole time.

Your information on the PSS is mostly correct, except its ammunition, SP-2, is not hollow-point, but flat-point.

Also interesting is that spent SP-2 cases eject with significant force. Cases are heavy and can hit bystanders hard. We were always ordered to collect all SP-2 cases after our drills. You wanted to wear gloves for this, since the spent cases were very hot.

Sergey S.  
Berlin, Germany

## POCKETKNIFE CONTROL INC.

In light of the brutal murders of Nicole Simpson and Ron Goldman by a knife-wielding assailant I have just one question: How many more people have to be slaughtered before these assault weapons are taken off the street?

As a concerned citizen I propose a group be formed called Pocketknife Control Inc. Our Founding Fathers, in their simple wisdom, could not have imagined the advances in knife technology, so banning knives is your basic no-brainer. People owning or collecting knives should take up other hobbies, like bowling or reading.

Accurate media surveys have shown 95% of a small sampling think it is past time for government to take control on this matter. As we all know, the average citizen can-

not be expected to use good judgment so the following laws should be enacted immediately:

1. A ban on all knives measuring under 4 feet (eliminating concealed carry).
2. The eventual banning of all knives (even pen knives can put an eye out).
3. Knife manufacturers should be forced to produce only specimens with no sharp edges.
4. Until we can socially engineer non-violent kids, all toy knives must be a bright color so they can't be confused with real ones.
5. Ban all sharpening stones and sheaths.
6. Ban knife shows and make it illegal for more than two people to gather and talk about knives.
7. Ban the sale of cheap imports and the notorious "K-Mart" Specials.

Once these nasty assault knives are off the street, America will be a safer place and our authorities can move on to more laws for the common good, such as banning baseball bats, scissors, rocks, etc...

Jack Hensley  
APO, New York

## RUNNING TO DADDY

I'm afraid that I find myself in fundamental agreement with "Lt. Commander Bitter," who wrote that he sees women as a special interest group with questionably loyalty to the military. The odd thing about this is that I'm a woman, a veteran of the Air Force and Air National Guard.

# SURVEILLANCE

## Pinhole CCTV Camera System

Complete pinhole system includes; 4mm pinhole lens, mini-CCD camera, mount, B&W monitor, cable, power supplies and a 24-hour time lapse VHS recorder. Retail \$3,650. **SALE \$2,495** (ship/ins \$35).

**Disguised cameras from \$495.** (Smoke detector, emergency lights, etc.)

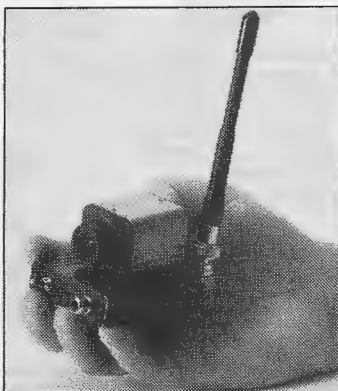

**COVERT VIDEO SPECIALISTS**

**Wireless Video Transmitters & Receivers. Call.**

**Complete CCTV system design and installation available worldwide.**



## Telephone Recording System

Complete system includes; extended play recorder, 140 minute cassette, power supply, telephone interface for standard single and multi-line telephones, alligator clip adapters for attaching the recorder anywhere along the telephone line. Includes everything you need to record your calls.

Starts and stops automatically. Voice activated. Optional "beep" mode. **EP-500 Telephone Recording System \$195** (ship/ins \$7).

Record for 12 hours with EPPi's **Professional Model Pro-12 Telephone Recording System \$399** (ship/ins \$19).

- **Call Logger II** - keeps an electronic record of all OUTGOING calls (phone numbers) made from any single line telephone. Even shows local numbers that your phone bill won't. Attaches anywhere along the line. **\$189** (ship/ins \$10).
- **Telephone Taps and Room Bugs.** How they're done and how to defeat them. Surveillance expert reveals trade secrets, step by step. Shows many of the actual devices. One hour VHS **\$49.95** (ship/ins \$4).
- **Israeli Instinctive Combat Shooting Method.** One hour step by step lesson. Filmed in Israel. VHS. Retail \$49.95 **Limited Offer \$29.95** (ship/ins \$3).



## Match Box Transmitter

**TK-100 Tuneable FM Transmitter Kit\* with matching receiver \$199** (ship/ins \$7).

**TK-500 UHF Crystal Controlled Professional Transmitter Kit\* \$349** (ship/ins \$7). Available

on two frequencies. Extra lithium batteries \$8 each. **Professional High Gain Two Channel Receiver \$1,200** (ship/ins \$20).

## Telephone Transmitter

**TK-200 FM Tuneable Transmitter Kit\* with tunable receiver \$199** (ship/ins \$7).

**TK-600 UHF Crystal Controlled Professional Quality Transmitter Kit\* \$399.** Two frequencies available. Works with scanner or professional high gain receiver.

**\*NOTICE: Transmitter kits require simple (10 minute) final assembly.**

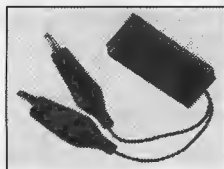

- **Body Wire and Receiver Set \$299** (ship/ins \$10)
- **Body Wire Detector \$695** (ship/ins \$10)
- **Complete Basic Countermeasures Kit \$1,495** (ship/ins \$35)
- **Tap Nullifier. Jams telephone taps. \$695** (ship/ins \$10)

## KGB Photo Sniper System

Camera, shoulder stock, 300mm lens, filters, carrying case etc. A tremendous value. **Only \$599** (ship/ins \$25). This is THE system used by surveillance teams in former East Block Countries.



## Night Vision

### WARNING!

**Not all Russian night vision is equal. Don't get burned buying cheap junk or units that produce dangerous x-rays.**

- Binoculars
- Riflescopes
- Handheld viewers
- Complete camera systems

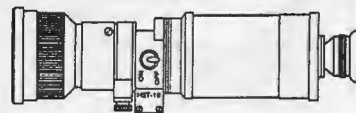

**Invest in quality at excellent prices. Call EPPi.**

## Audio Surveillance Kit

Includes;

- |                              |                               |
|------------------------------|-------------------------------|
| Body wire and receiver,      | Receiver for FM Transmitter   |
| VHF crystal controlled       | Touch Tone decoder            |
| Telephone recording system   | Call Logger                   |
| Mini microphone w/amplifier  | Lineman's handset (telephone) |
| and 25' cable                | Contact microphone            |
| FM Match Box Transmitter Kit | Telephone Infinity Ear        |
| FM Telephone Transmitter Kit | Taps & Bugs Video             |

Assembled in a briefcase. **\$1,495** (ship/ins \$25).

NOTICE: These products are intended and sold only for the purposes of testing and experimentation and training in electronic countermeasures. Any other use may be illegal. FCC licensing may be required prior to assembly. Not to be used for surreptitious interception of civil communications. All equipment is sold subject to public law 90-351, title III, 18 U.S.C. Section 2511. All local, state, and federal ordinances, rules, regulations, etc. It is the sole responsibility of the buyer (not the seller) to consult legal counsel for interpretation of any laws applicable to the area of intended use.

**Catalog \$5**



## Surveillance/CounterSur.

**Hands-on Seminars**

Two days - held bi-monthly

**\$495**

**Call for dates and reservations**

**Executive Protection Products, Inc. - The Professionals**

1325 Imola Ave. W. #504S, Napa, CA 94559 707-253-7142 FAX 707-253-7149 MC/Visa

# Venom™



**THE MOST POWERFUL...THE MOST POTENT...THE MOST EFFECTIVE DEFENSE SPRAY AVAILABLE!!!** We're serious about your safety, and nowhere is that more evident than in our line of Chemical Defense Spray VENOM. VENOM was developed to provide you with the highest degree of non-lethal protection available. VENOM is formulated to give optimum performance from each size unit. VENOM is fast acting and hard hitting, and is effective against even drunks, drug abusers, and psychotics.

- 3 Ounce Home/Auto Unit (Maxi-Blast top).....\$24.95
- 3/4 Ounce Pocket/Purse Unit.....\$11.95
- 3/4 Ounce Keyring Unit.....\$15.95  
(PLUS \$3.50 Shipping)

## THE WORLDS FINEST SLIM JIM

Our premium quality car jimmy tool is made of high quality spring steel, with rounded edges and textured black rubber handle. Comes with instructions.

SJ100.....\$9.95  
(PLUS \$3.50 Shipping)

## COBRA III+ ELECTRONIC LOCK PICK

\*OPENS 99% OF ALL PIN TUMBLER LOCKS IN 7 SECONDS OR LESS\*

SUPER HALOGEN BULB LIGHT UP ENTIRE KEWAY

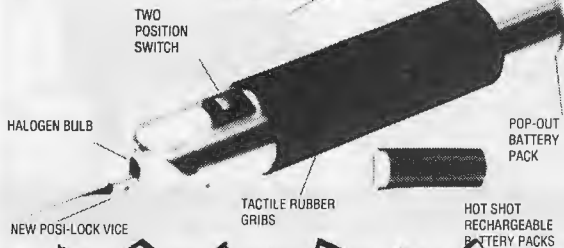

## LAST CHANCE

To Buy a Cobra III+ For \$399.00  
Factory Price Increase to \$499 11/1/94

It's... are manufactured from... all pin...  
tumble... comp... are man... ure from... ace aluminu...  
alloy... a lifetim... quality, hassle-free service. The new Cobra III+ is packed with  
all new features. Our exclusive high-intensity focused halogen key way light source; new  
tactile rubber grip; extra rechargeable "Hot Packs". The Cobra III+ is shipped complete with  
rechargeable Hot Pack wall charger, extra picks, tension tools, allen wrench, and shipping  
case.

Cobra III+.....\$399.00  
Comes complete in die cut shipping case (PLUS \$10.00 Shipping)

For our Florida customers, and our friends in law enforcement and military - write or call for a listing of our automatic collector's knives.



**MAXIMUM SHIPPING CHARGE PER ORDER - \$10.00**  
**CHECK, MONEY ORDER, VISA, OR MASTERCARD**  
Full Line Catalog \$2.00



**WARNING: Check State & Local laws regarding use & lawful possession of items above.**  
**Must be 18 years or older to order.**

# SOUTHERN ORDNANCE

"The hardest hitting products in the personal defense industry"

P.O. BOX 279 • DEPT. SF • Babson Park, Florida 33827

**FAX (813) 638-2486 (813) 638-2499**

## D100 SAP GLOVES



Made of soft, pliable deerskin, these gloves have 6 ounces of powdered lead inserted across the knuckles of each fist. Discreetly effective.

D100.....\$69.95  
D-50 (Cowhide).....\$37.95  
(PLUS \$4.50 Shipping)

## LEATHER SLAPPER

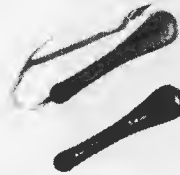

The highest quality slappers available. Constructed of smooth top grain cowhide with a leaded striking end. Available with or without a wrist loop. Made in U.S.A.  
BBL20.....\$19.95  
BBL21 (With wrist loop).....\$19.95  
(PLUS \$3.50 Shipping)

## POCKET PROTECTOR



Press the pocket clip and a 4 1/2 inch long, 1/4 diameter spike extends from the body of the device, providing 10 1/2 inches of potent protection. Rugged, all steel construction.

GFR.....\$55.00  
(PLUS \$4.50 Shipping)

## BRASS KNUCKS PAPERWEIGHT

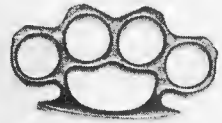

The finest product of its kind available—add a beautiful example of the metal worker's art to your collection.

KNB.....\$13.50 ea  
\$24.50 pr  
KNA Lightweight Aluminum  
KNA.....\$8.00 ea  
(PLUS \$3.50 Shipping)

## Z-FORCE STUN GUNS



Z-FORCE stun devices are the best we've found! They offer reliability, high sustained voltage output and concealability - these devices are compact and powerful.

ZF-3, 100,000 Volts.....\$44.95  
ZF-4, 120,000 Volts.....\$69.95  
ZF-Ultra, 150,000 Volts.....\$99.95  
SouthOrd Security +, 200,000 Volts.....\$119.95  
(PLUS \$5.50 Shipping)

## "ACE PICK" TUBULAR LOCK PICK



Opens vending machines, T-top locks, washing machines, etc. This precision tool is made of HIGH QUALITY, HEAT TREATED STEEL, and picks tubular locks with mushroom pins. Includes a decoder and is available for center or offset locks.

APC 7 (7-PIN).....\$89.95  
APC 8 (8-PIN).....\$89.95  
BOTH PICKS.....\$159.95  
(PLUS \$5.50 Shipping)



## BLACKJACK

These law enforcement weapons, once the standard of police officers throughout the country, are finely crafted from lead, steel spring, and leather. Eight ounces of nostalgic protection. Made in U.S.A.

BJK8.....\$19.95  
(PLUS \$3.50 Shipping)

## PXS 14 LOCKPICK SET



This 14 piece set includes everything you need to open most locks and doors—an assortment of picks and rakes, two tension wrenches, a broken key extractor, and cowhide pocket case. Includes the book, Easy Pickins.

PXS14.....\$32.95  
PXS17.....\$49.95  
(PLUS \$3.50 Shipping)

I do have loyalty and honor and was a damned fine aircraft mechanic who was well-liked and respected at each duty assignment. One thing we "enlisteds" quickly learned about pilots, both on and off duty, is that as a rule they party as hard and "dangerously" as they fly.

My first thought about Tailhook was that if you can't stand the heat get out of the kitchen. That does not mean you have to leave, it just means you have to make it stone clear that you aren't playing. I don't care how drunk a captain got, "get the hell out of my face," always worked for me. Conklin and Warnick chose to play and then went running to "daddy" to save their own asses.

Sadly, the result of this kind of behavior is that both men and women will be treated more and more like children by a government that begins to look more and more like "mommy" — and who wants all of us to "play nice," when all we really want to do, and need to do, is flex our muscles and play in a manner that prepares us for the real world. The real world that will kill us if we don't learn the necessary skills.

*Name withheld on request*

### "LAP DOGS" ON THE MONEY

I just finished reading "Lap Dogs Lead The Way" (SOF July '94) by Colonel David Hackworth and am sad to say I agree with him.

In the Persian Gulf with the 101st Airborne, I witnessed some of the most disgraceful acts I have ever seen in the military. For one, just before returning to Saudi Arabia from Iraq, our commanding officer (a lieutenant colonel) told the S-1 to write up Bronze Star citations for every officer in the unit, O-3 and above. When the S-1 questioned this, the colonel answered: "We have to think of what will happen to their careers if we don't."

Many officers in the unit spent most of the time and energy of the enlisted soldiers in efforts to showboat, kiss ass and advance themselves in any way they could. The commonly uttered phrase of the soldiers was, "I love a parade."

A captain on our staff was awarded a Bronze Star for valor

when he led troops out of a "friendly" minefield that he had led them into in the first place. A master sergeant abandoned a trailer full of classified documents when it broke down in Iraq. He left the classified paperwork but remembered to take the major's coffee-maker. Luckily, U.S. troops recovered the trailer and the incident was covered up.

*Name withheld on request*

When I served in the Army, we trained hard, but dumb. Sure, we ran and ran, did push-ups, went on field exercises and the like, but we never received any training on enemy tactics or weapons.

The only tactical training we did was the old "get on line and assault" stuff. All of our questions were answered with "When you get to your unit, they'll teach you how they want it done," and when you got to your unit, you were told "They were supposed to teach you that in AIT."

After three years I left, having served my obligatory year in Vietnam. Every officer and senior NCO in my battalion received a Bronze Star during my tour. Every one! I can't say that any one of them shirked their duty, but how could they all qualify for the BSM?

Kurt J. Fischer  
Pittsburgh, Pennsylvania

The hypocrisy of active-duty admirals over the past three years is appalling. Even today, I hear of flags stating that they have to preserve "our most precious asset — our people," yet none of them uttered a word in defense of the junior officers who were thrown to the political wolves.

A proud Tailhooker

Colonel Hackworth keeps a bright and shining light focused on the salient issues. His article on the lack of military leadership was illuminating and on target. Not many have his prescience, nor have many been whereof he speaks. I hope he appreciates the importance of his message and continues to step forward. He is a national resource.

Dave Jonta  
Ridgecrest, California ✕

# YOU HAVE NEVER SEEN A CATALOG LIKE THIS!



*The 1994 Edge Company Catalog*

*Over 60 blazing full-color pages of the most incredible knives, action gear, electronics, self-defense, and optics your eyes have ever feasted upon. Now get in on:*

- One-Handed Knives
- Night Vision Scopes
- Automatic Air Pistols
- Hunting Knives
- Tear Gas Revolvers
- Locksmithing
- Car Alarms
- Watches, Lighters
- Sword Canes
- Bugging Equipment
- Stun Guns
- Pistol Crossbows
- Samurai Swords
- Tap Detectors
- Stiletos
- Voice Disguisers
- Black Powder Guns
- Spy Equipment

*And a thousand more, all with an iron-clad, rock-solid, money back guarantee.*

**Get Yours Today!**

*Send \$3.00 for a full 2 year subscription, to:*



**THE EDGE COMPANY**

P.O. Box 826, Dept. SF10  
Brattleboro, VT 05302

Or call toll-free

**1-800-732-9976**

*Please allow a couple of weeks for your first catalog to arrive. Thanks!*

# Professional Locksmithing Tools

## LOCKAID

Specifically designed to pick tumbler locks. Designed over thirty years ago to aid law enforcement agencies. Consists of tension wrench, three needles and Lockaid "Gun." Prices include a copy of the book "Lock Picking Simplified."  
**Lockaid \$69.95**



## PIX MODEL 13

This deluxe yet compact kit features 11 of the most commonly used tools. Comes in a slim cowhide leather case for discreet undercover operatives. As a special bonus, a 5 piece set of warded picks is included. A 16 piece set total. Also included, a copy of "Lockpicking Simplified." Receive all this at a Low price of:  
**Pix 13 \$42.95**



## PXP 8

- Shirt Pocket Size.
- Top Grain Cowhide Leather.
- Has 8 Picks, Tension Wrenches and Broken Key Extractor.
- All Picks with Metal Handles.
- Copy of Lockpicking Simplified.

**PXP 8 \$24.95**

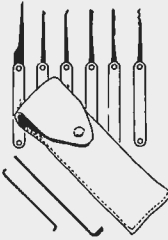

## PXP 10

- Shirt Pocket Size.
- Top Grain Cowhide Leather.
- Has 13 Picks, Tension Wrenches and Broken Key Extractor.
- All Picks with Metal Handles.
- Copy of Lockpicking Simplified.

**PXP 10 \$34.95**

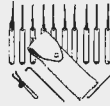

## PIX-EZ All-In-One Pick-Set

100% American Made!  
 As convenient to carry and use as a pocket knife!  
 Only 4 inches long, half inch square, weighs under five ounces, works fast and opens pin and waster tumbler locks quickly, with very little effort. Six tempered spring steel picks, tension wrench.  
**\$34.95**

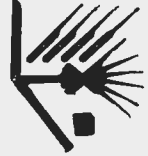

## WKS PICKS

Made of the finest blue tempered spring steel this 5 piece padlock pick-set is a must in every locksmith's tool box. This set will pick open most every warded padlock made today.  
**\$9.95**



## NEW MONTHLY SPECIAL

RECEIVE A COMBINATION SET  
 INCLUDES — 5 ITEMS

1-MD-16 DELUXE SET .....	\$59.95
1-SCHALGE WAFER SET .....	\$27.95
1-SESAMEE DECODER .....	\$17.95
1-WKS PICKS .....	\$ 9.95
1-DOUBLE SIDED TUMBLER PICKS .....	\$27.95

A VALUE OF \$143.75  
**AT A LOW PRICE OF \$89.95**

Lockpicking Simplified	\$8.50
Complete Guide to Lockpicking	\$15.00
Improvised Lock Picks	\$9.95
Tubular Locks	\$8.95
Lockout and forced entry	\$8.95
Involuntary Repression	\$10.95

Safe & Vault manipulation	\$9.95
How to Pick Pins & Wafers	\$9.95
Combination Locks	\$8.50
Keys by Impressioning	\$7.00
Key Casting Manual	\$8.95
Locks, Picks, Clicks	\$10.00



## ESP-13

This handy new pick set is the most popular set among professional locksmiths today. This kit consists of 12 different tools housed in a handsome black leather case designed for a shirt pocket. Included in the price, you receive a 5 piece warded key set and a copy of "Lockpicking Simplified." 17 piece set total.  
**ESP-13 \$45.95**



## KEY RING PICK SET



This unique design is ideal when low profile is required or to keep on your keyring for emergencies. Contains a tension wrench, three picks and the "Key Pick."  
**Key Ring Pick Set \$27.95**

## DOUBLE SIDED DISK TUMBLER PICKS

Set of 4 picks designed to be used on the most popular double-sided disc tumbler, showcase, cam and padlocks.  
**\$29.95**



## MINI PICK TUBULAR

The most effective tubular pick on the market, unlike the larger picks with long handles or screwdriver handles. The longer the tool, the more pressure needed which causes easy breakage. The advantage of the Mini Pick is it is so short, you only use your thumb and index finger. With a little practice this tool will open a tubular lock in less than a minute.  
 A. Your Choice: (1) Center (2) Offset left (3) Offset right; B. "Segal" 6 pin tubular; C. 5-pin Tubular; D. 6-pin Tubular; E. 8-Pin Ace.  
**\$79.95**

## SESAMEE DECODER

This tool was designed to decode the exact combination of a sesamee padlock without damaging the lock. Detailed instruction included.  
**\$17.95**



## SCHLAGE WAFER

The most fantastic tool you will ever use. This set consists of two base keys and pick. Complete instructions included.  
**\$29.95**

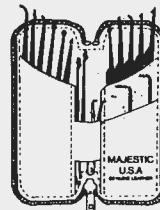

## MD16

Shirt Pocket Size, Top Grain Cowhide Leather, Zippered Case, has 16 Picks, Tension Wrenches and Broken Key Extractor.  
**\$59.95**

## MD32

Hip Pocket Size, Top Grain Cowhide Leather, Zippered Case, has 32 picks, Tension Wrenches, Broken Key Extractor.  
**\$69.95**

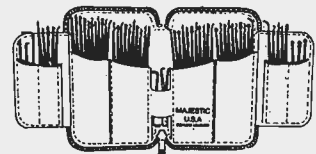
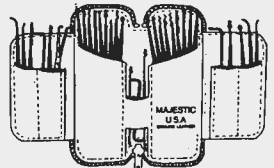

## MD60

Top Grain Cowhide Leather, Zippered Case, has 60 picks, Tension Wrenches, Broken Key Extractor and Warded Master Keys.  
**\$99.95**

Catalog \$3.00  
 Free with order.  
 Sorry, no credit card orders



The law requires all purchases be made in good faith, without make believe or fraud by genuine persons within this industry

Send to  
**Steve Arnold's Gun Room**  
 postage & handling \$5.00  
 Overseas Surface \$6.00  
 Add 30% of total for overseas mail.  
 Must be 18 years of age.

P.O. Box 68, Dept. SF10, Dexter, OR 97431; (503) 726-6360

## Adventures of Ranger Rick

Text & Photo by  
Ranger Rick Tscherne

**I**n 1986, while assigned to an airborne unit in Vicenza, Italy, I was deployed to "Graf," Germany, to act as the Drop Zone Safety Officer (DZSO) for Bunker DZ. I was responsible for deciding whether or not the battalion would jump. A young, inexperienced captain with far fewer parachute jumps than I was my assistant DZSO. He was a good officer overall, but known to be quite vulgar and dirty-minded — obviously not a West-Pointer.

The morning of the drop, just as we were preparing to do our DZ safety checks, I saw a line of vehicles pull up to a large set of bleachers overlooking the drop zone. It appeared we were going to have quite an audience watching our massive jump of 1,000 paratroopers and 30 vehicles from 25 C-130 aircraft.

This wasn't unusual; a parachute drop always drew a crowd. I noticed a few loudspeakers, but assumed they were for an announcer. However, on this occasion the loudspeakers were erected so spectators could listen in on our radio frequency during the parachute drop. Unfortunately, nobody told the DZSO or assistant DZSO about this.

The closer it got to drop time, the more people arrived. There appeared to be quite a few women and children anxiously waiting for the show. Both bleach-

ers and viewing stands were packed. VIP sedans pulled up with colonels and generals. This was going to be quite a circus act.

At one minute to drop time, my assistant DZSO was positioned on the trail edge of the DZ, about three clicks away. I was on the leading edge with an Air Force Combat Control Team (CCT) who were busy talking with the aircrew and checking wind readings. The CCT leader turned to me and said, "Winds 5 knots; visibility five miles; first drop will be vehicles followed by troops five minutes later. Aircraft on final approach. Drop or no-drop, sergeant?"

"Let 'em drop!" I replied.

The first six aircraft flew overhead and successfully dropped their loads of vehicles over the DZ. As I watched the chutes open, I noticed one pallet dropping much faster than the others — its parachute had failed to deploy. From 1,200 feet it tossed and turned, over and over, and then crashed. It landed only a few hundred meters from where my assistant DZSO was positioned. On my radio I heard him say (breaking all comms procedures), "*Hey Ranger Rick, did you see that motherfucker burn in? That son of a bitch landed only 100 fucking meters from my ass!*"

Nearly simultaneously I heard the echo of loudspeakers broadcasting his words across the entire

drop zone, followed by uneasy laughter from the crowd of spectators. Although my battalion commander chewed my ass over this incident, he took a much bigger bite out of the captain.

### Stand Up, Un-Hook, Shuffle to the Door

Another incident that comes to mind happened in 1984. I was one of two jumpmasters assigned to a C-130 aircraft fully loaded with paratroopers. The other jumpmaster was my company commander. He was a real shithead, not for his tough-

aircraft. Ground winds were even worse, but naturally we still wanted to attempt a jump. After what seemed like hours of tossing, turning and getting banged up in the aircraft, everyone started to get sick. The pilot informed us over the intercom that the jump was a no-drop. "Thank God," everyone sighed in relief. Half of the troops were already vomiting all over the aircraft, and there weren't enough barf bags for everyone.

I disconnected my static line and took a seat in the rear of the aircraft. I put my head between my



"Let 'em drop." This M151 jeep burned in at Grafenwöhr, Germany, to the amusement of the crowd, and the dismay of an assistant DZSO.

ness, but for his ignorance and propensity to blow things out of proportion — again, obviously not a West-Pointer.

We had been airborne for about an hour. High winds were causing vicious turbulence, bouncing us around inside the

legs and didn't have to wait long to vomit. The captain unhooked his static line and took a seat on the raised back ramp of the aircraft. I noticed he was smiling — he wasn't sick, yet.

Continued on page 73



# WORLD SITREP

1

## UNITED STATES

Army Secretary Togo West withdraws controversial plan allowing women assignments in artillery crews, special forces aviation, air defense and engineer units after heavy opposition from Army Chief of Staff Gordon Sullivan. Defense Secretary William Perry reports women will eventually be assigned to all surface ships.

Army confirms it sprayed chemicals over Minneapolis and other cities during 1953 tests designed to study spread of chemical and biological agents. Unusually large number of stillbirths and miscarriages occurred in Minneapolis during that period.

In crash program to monitor world trouble spots, Pentagon is spending \$1 billion to develop unmanned version of U-2 spy plane and an entirely new unmanned stealth recon plane. Armed Services Committee includes funding to reactivate SR-71 Blackbirds in FY95 defense budget.

2

## RUSSIA

Arrests three men trying to sell 7kg of highly enriched uranium — enough for one bomb — to Germany, and expels five North Koreans for “showing too much interest in nuclear components.”

250 U.S. Marines land on Klerka Peninsula in Russian Far East as part of joint exercise with Russian marines simulating an earthquake relief mission. A similar exercise is planned in California next year.

Becomes 21st nation to sign NATO partnership agreement and thereby accepts the principle that it cannot stop other East European states from joining.

1

6

## SOUTH/NORTH KOREA

U.S. forces in Korea ask Pentagon for 170 additional specialists in intelligence, operations and training, and electronic warfare.

World's longest reigning dictator and self-proclaimed “Great Leader,” Kim Il Sung, dies of natural causes, stalling talks on nuclear crisis. His erratic son Kim Jong Il is expected to take over.

7

## SOUTH AFRICA

Crisis develops as tens of thousands of blacks occupy land in various areas expecting to be given ownership by new black government.

11

## IRAQ

Project Babylon — 1,000mm super gun project — was designed to fire guided rockets, not cannon shells. Twelve-foot rockets reportedly carried warheads weighing 48 to 220 pounds.

17

12

## PERU

Police disarm 375-pound Shining Path bomb made of dynamite, fertilizer and diesel fuel.

Police arrest Abdon Cruzat (Comrade Ricardo), one of the last top Shining Path rebels and the man in charge of planning terrorist attacks in Lima.

12

16

## PHILIPPINES

Government force of 1,500 marines and police launch assault on mountain stronghold of Muslim Abu Sayyaf guerrillas but are repulsed and call in Army Ranger reinforcements.

15

## IRAN

Has been able to break into U.S. communications networks for the past several years, resulting in capture of at least 30 agents.

4

### BOSNIA

Serbs launch new wave of ethnic cleansing at Banja Luka and take nearly \$500,000 in bribes to allow Muslims in concentration camps to flee abroad.

400 Iranian Revolutionary Guards arrive in Zagreb, link up with tons of weapons and munitions, and move into Bosnia to form new units from Muslim fundamentalists as a result of new Croat-Muslim alliance. Missions will be run from Iranian embassy in Zagreb.

5

### YEMEN

Northern forces continue relentless attack and succeed in outflanking defense line northeast of Aden. Southern leaders panic and flee to Saudi Arabia. North declares victory in civil war.

3

### ESTONIA

Passes new border law, effectively claiming several areas now controlled by Russia.

2

8

### SWEDEN

Stockholm International Peace Research Institute reports 34 wars in 1993, compared to 33 in 1992. SIPRI counts a war as a conflict with at least 1,000 deaths per year.

9

### GERMANY

Flatly rejects ultimatum from U.S. Congress that it pay 75% of cost of basing U.S. troops in Europe.

Plans to devote 25% of its army, 33% of its air force and 40% of its navy to a new crisis reaction force recently authorized to participate in foreign "peacekeeping" (i.e., combat) ops.

10

### JORDAN

Sources report that in spite of trade embargo, Iraq is Jordan's largest trading partner.

6

16

14

### SOMALIA

Scotland Yard investigators learn \$4 million missing from U.N. headquarters had been kept in a filing cabinet because safe in cashier's office was too small.

U.S. helicopter carrier *Guam* and three landing ships carrying a Marine battalion position off coast to evacuate westerners in an emergency.

11

15

10

5

14

13

### SUDAN

SPLA rebels hijack barge carrying relief supplies destined for desperate government forces in Juba.

Government troops capture rebel stronghold of Kako Kajl.

17

### NICARAGUA

Military prosecutor clears Gen. Humberto Ortega and his bodyguards of murder charges dating back to 1988.

New Jersey Rep. Robert Torricelli warns Nicaragua that it will lose U.S. aid if it does not compensate Americans for property confiscated by Sandinistas.

World SitRep is excerpted from the biweekly newsletter *For Your Eyes Only: An Open Intelligence Summary of Current Military Affairs*. Published by Tiger Publications, P.O. Box 8759, Amarillo, Texas, 79114-8759; subscriptions are \$65 per year (26 issues). Sample issue available for \$3. Those interested in reliable, up-to-date world intel are encouraged to subscribe.

# PASSPORT TO ADVENTURE

Enter today and you may win one of these exciting prizes

## GRAND PRIZE — ALL-EXPENSES PAID SAFARI!

Round trip from New York City's JFK Airport to Johannesburg, South Africa, for one person. Includes: transportation to and from hunting areas, guide, tracker and skinning fees paid, hunting fees for up to ten days, trophy fees for:

- A) One Impala B) One Warthog C) One Steenbuck D) One Duiker
- E) One Bushbuck F) Choice of one Zebra, one Wildebeest or one Waterbuck
- G) Shipping of above capes and horns to American Taxidermy, Tallahassee, Florida

## TRIP FOR TWO TO THE SOF CONVENTION/EXPO IN LAS VEGAS, NEVADA!

September 27 — October 1, 1995. Includes round-trip airfare, 4 nights at the Sands Hotel, \$500 in spending money, full admission to the SOF Convention/Expo, plus all Convention privileges!

## SECOND PRIZE — RUGER AUTO P90 .45 STAINLESS DECOCKER PISTOL

### THIRD — TWELFTH PLACE PRIZES

Inscribed  
Al Mar Knives

100 CONSOLATION PRIZES —  
One year subscriptions to SOF's quarterly  
publication FIGHTING FIREARMS

This is your opportunity for excitement and adventure — sign up today for big savings on subscriptions and a chance at adventure and prizes!

# SOF 19th Anniversary Sweepstakes

The Journal Of Professional Adventures is celebrating 19 exciting years and wants you to have a chance at **BIG** subscription **SAVINGS** and **LOTS** of **GREAT PRIZES!** Enter today! All entries must be postmarked by Dec. 30, '94. No purchase necessary.

## How To Enter

Fill out the entry card (or coupon) and send to *SOF*, P.O. Box 348, Mt. Morris, IL 61054-0348 via U.S. mail with entry postmarked no later than 30 December 1994. No entries will be accepted after this date. Winners will be selected by random drawing on 9 January 1995, and will be notified by mail or telephone. No purchase necessary to enter. All prize winners must comply with Federal, State and local firearms regulations, where applicable. Judges' decisions are final. Sweepstakes open to residents of the U.S. 21 years of age or older. Prize non-transferable. Odds of winning are dependent upon total number of entries. Winner will be printed in a future issue of *Soldier of Fortune*.

• For name of prize winner, send a SASE to '94 Sweepstakes Winners List, c/o *SOF* Magazine, P.O. Box 693, Boulder, CO 80306

## Limit of Liability

1. Both *Soldier of Fortune* magazine and *Roc Safari* will make every effort to ensure the safety of the winner of this safari, however the winner must sign a waiver of responsibility prior to the safari releasing both *Soldier of Fortune* magazine and *Roc safari* from any financial responsibility for any injuries the winner may receive while on safari, or as a result of the safari.

2. The Winner of the safari must provide his or her own health or accident insurance during the safari.

3. Neither *SOF* nor *Roc safari* will be responsible for providing legal services or financial help should the winner of this safari attempt to circumnavigate any import or export laws of any country during travels connected with this safari and violation of any of these laws will be just cause for the immediate cancellation of the safari.

4. In the event that the Safari, for reasons outside the control of *Soldier of Fortune*, becomes impossible or impractical, the alternate Grand Prize of a Trip for Two to the *SOF* Convention/Expo will be awarded. *SOF* will be the sole judge of whether the safari has become impossible or impractical.

## YES, HERE'S MY ENTRY

- Enter my name, send me a 1-yr. sub. for \$26.00  
 Enter my name, send me a 2-yr. sub. for \$50.00  
 Enter my name in the sweepstakes only.  
 Credit card orders may call  
**1-800-877-5207**

- Payment enclosed (U.S. funds only)  
 MasterCard  Visa Exp. Date \_\_\_\_\_

Card# \_\_\_\_\_

Signature \_\_\_\_\_

NAME \_\_\_\_\_

ADDRESS \_\_\_\_\_

CITY \_\_\_\_\_ STATE \_\_\_\_\_ ZIP \_\_\_\_\_

DAY PHONE ( ) \_\_\_\_\_

Payment must accompany order. Offer good in the U.S. and Possessions, including APO-FPO addresses, for a limited time only. Canada add \$10.00 per year (includes GST #R128476249). Allow 6-8 weeks for delivery of first issue.

POSTMARK DEADLINE: 30 December 1994  
SWEEPSTAKES DRAWING: 9 January 1995

**MONEY BACK GUARANTEE**

(SEE ATTACHED SWEEPSTAKES RULES)

ANW 104

# SLICK WILLIE WATCH



## UNCONDONED CONDOLENCES

The Washington media flacks are taking swipes at Sen. Bob Dole as we go to press because Dole (Purple Heart) took exception to Clinton (Yellow Belly) sending condolences "on behalf of the American people" to North Korea on the death of dictator Kim Il Sung. As columnist Mike Royko noted, "...it seems presumptuous of him to casually toss about the condolences of every person in this country. If he wants to send flowers, he shouldn't put our names on the card without asking."

We see reason for nothing but celebration — not condolences — to mark the death of a tyrant who started a war that killed more than a million Korean civilians, more than 200,000 Korean troops, and some 53,000 Americans.

How's this for a message to North Korea (and the White House) "On behalf of the American people": *Get stuffed. We won't miss you.*

## RATIONALIZE THESE QUOTES

In a 1977 *Penthouse* interview: "I take second place to no one in my hatred of the intelligence agencies." In a piece he wrote for *Washington Monthly*: "On the night of the Cambodian invasion, part of me wanted to blow up buildings, and I decided that those who have waged this war really should be treated as war criminals." After attending

a 1977 speech by Ngo Dien, Vietnamese deputy foreign minister of press and information, as part of the new Vietnamese U.N. delegation harshly condemning the American imperialists, his reaction was: "I am deeply moved. It's difficult to describe my feelings — what can you say when the kinds of things that 15 years of your life were wrapped up in are suddenly before you?"

Where is the man who said these things today? He's Clinton's sorry choice to be our ambassador to the Vienna-based Conference on Security and Cooperation in Europe: Sam Brown. Another New-Far-Left Carter Administration retread, Brown was head of ACTION under Carter when a House appropriations committee probed his poorly run department and issued a report revealing numerous violations of law, policy and regulation. A genuine dingbat. A typical radical-left Clinton sleeper.

## BUY A PIECE OF THE PRESIDENT UPDATE

We now have the correct POC for the president's legal fund: President's Legal Expense Fund, Department 70, Washington, DC 20055-0070. Press reports are that they are limiting donations to \$1,000: If you want to buy a bigger piece of the president you'll have to work through your brothers, cousins and aunts, or your cattle-futures broker.

## PAULA JONES LEGAL FUND

Before you send your 47-cent check (a dollar after taxes) to Slick's high-priced lawyers, you might want to dig deep and send a gift to the Paula Jones Legal Fund, Washington, DC 20069. Any funds that remain after her sexual harassment suit against Clinton will go to charity: There is no limit to donations. Be politically incorrect and send what you can.

## YEAH, BUT OTHER THAN THAT...

You've heard of the "prophet who hath no honor in his own country" haven't you? Here's a quote you may like, from Judge Jim Johnson, a retired state senator and former Arkansas supreme court justice: "I guess the first thing I want to say on behalf of the decent people of Arkansas is to apologize to the world for our having foisted upon you a president of the United States who is a queer-mongering, whore-hopping adulterer; a baby-killing, draft-dodging, dope-tolerating, lying, two-faced treasonous activist."

## PAY OFF THE NATIONAL DEBT?

Maybe Clinton does have a useful talent: pay-offs. According to *The New Republic*, as a nurse-anesthetist, Clinton's mother Virginia once let a patient die while she did her nails, rather than monitor the patient. She was found to be criminally

negligent — then was mysteriously cleared. Her son, the governor, then promoted the official who cleared her. Also clearing her was Joycelyn Elders, now our surgeon general (whose son, according to *The New York Times*, was arrested for cocaine sales and whose husband owns a crack house).

Remember the bruhaha over pardons signed by a temporary Arkansas governor during Clinton's inauguration? *The Washington Times* now reports these pardons were engineered by Clinton before he went to Washington. One of the criminals freed was the son of a state senator who had been distributing names, addresses and photos of Clinton's black and white illegitimate children. Some of these "woods colts" are the spitting image of their dad — but it was all dropped when Clinton agreed to spring the man's son, the *Times* reports.

If you can or will do something for Ol' Willie, looks like he'll take care of you. We'd better not speculate why he keeps pushing the homosexual agenda.

## NICE FAMILY

The family circle can get pretty large and "diverse" when your tribe has an "expansive" sexual outlook. Not only is Clinton's brother Roger a convicted coke dealer, but he has a half-sister who is a convicted bank robber. We don't know about any of the half-brothers yet unacknowledged. ☒

**"And, of course, the most amazing thing is how fast you can learn it!"**

## **Top Secret Hand-To-Hand Fighting System Finally Released To Limited Number Of Civilians!**

**Now, with the sudden release of this incredible elite military fighting system, you can easily "take down" trained boxers, Karate black belt masters and street thugs twice your size... even if you've never been in a real fight before in your life!**

— by Dr. R. L. Horine —

Dear Friend,

A year ago I would have *never* written you this letter. You see, I've gotten on the "inside" with some of the most dangerous soldiers and law enforcement people on the planet (including members of the Navy SEALs and combat instructors for the DEA, Army Rangers, major police department SWAT teams and others.)...

We all shared the same arrogant attitude: This new "simplified" hand-to-hand fighting system created for combat and intense criminal warfare should *not* be released to the general public. Because...

### **It's Just Too Dangerous To Be Allowed To Fall Into The Wrong Hands!**

I initially felt the same. But I've recently changed my mind in a big way... all because of a beautiful woman named Julie. I'm ashamed that I withheld these important street-fighting skills from people like her — good people (like you, too), who are *unnecessarily* walking the streets as living targets for the criminal scum who prey on innocent victims and just love to humiliate and ruin people's lives.

**Here's what happened:** Julie was assaulted and badly beaten, by a man she could have easily knocked unconscious and escaped from — if only I had taken **15 minutes** to teach her what to do! It doesn't matter that she's a petite and gentle woman. The few simple skills of this new fighting system can be taught to *anyone* in an almost unbelievable short time, because it requires no strength, no agility, no special talents, no speed, *no nothing!* Forget what you see on T.V. — the most effective fighters in the world never use spinning head kicks or elaborate punches... in fact, they never "punch" at all. It's all so much more **simple** than that — I've seen 60-year-old grandfathers and 13-year-old teenagers *master* this stuff almost overnight. For people like *you*, well, it's even easier.

Julie knows how to defeat 99% of all street thugs **now**... but she was taught just a little too late to avoid those emotional scars she'll have to live with for the rest of her life. And now, in all honesty, I'm doing my damned best to make sure every "good guy" I can reach *never* has to

go through what this lovely lady did...

### **And I Don't Care What The Military, Or Anyone Else, Says!**

**Here's the bottom line:** How safe do you feel in today's jungle-world? Are you even remotely interested in learning how (in a matter of mere hours) to turn any attacker or bully into a pile of bleeding beef at your feet — and so *automatically* — that you (or your loved ones) can always *terminate a dangerous physical assault situation before it even begins?* Would you like to have the confidence to walk nearly any street in the world, any time of day or night... knowing without question you can "neutralize" the threat of physical assault by criminal scum as easily and thoughtlessly as you would shoo away an alley cat?

I guarantee that if you are like every other man I've talked with in the last year, just *reading* this short message you have in your hands will start amazing changes to happen in your life! Changes that will turn you into a true modern-day warrior...

### **With So Much New Confidence Leaking From Your Pores People Will Take Notice From Across The Room!**

I don't care if you're in the worst physical shape of your life, or even if you've never hit another person before, or don't have the coordination to walk and chew gum.

Julie learned it... *and* a thousand guys smaller and weaker than you have learned it, too. Almost *overnight*. A Navy SEAL combat instructor told us that this fighting system can turn *anyone* into a potent hand-to-hand fighter. He said it's amazingly easy to learn, easy to remember, and best of all, easy to *use* when needed!

Are you skeptical? Good. That means you're not gullible, not easily fooled. But then almost everyone I've met in the last year has been just as skeptical as you. And listen to what happened:

— A pint-sized writer I know from Los Angeles was nursing a broken rib when he was bear-hugged from behind by a construction worker bully who outweighed him by at least thirty pounds. Now, this writer had never been in a real fight before in his life... in fact, his

only training came from just *watching* the 8 basic moves of this fighting system on video tape... one time! Yet he automatically used one of those "moves" the second he felt his rib begin to give...

### **And Was Astonished To Turn Around And See His Attacker Down And Whimpering On The Sidewalk!**

— A fairly well-known West Coast body-builder and ex-college middle linebacker named **Bob Pierce** (6 foot 4, 240 pounds of raw muscle), who also had studied Judo for 4 years, absolutely did *not* believe that a little guy like me (5' 6", *maybe* 170 lbs. soaking wet) could "put him down" *if he surprised me from behind!* Well, I did... and he's still tender where I "controlled" him with the simplest little move — and damn lucky I decided not to teach him a *real* lesson about going after smaller guys!

— A working mother named **Cindy Bowes** from Ohio... after *glancing* at this stuff (on a video), could only remember **one move** when she was assaulted by a man on her front lawn — but that one move put her assailant into such a boggled state that she was able to leisurely call the police and have him hauled off.

**Here's how this amazing fighting system "leaked" from the most elite military circles into your hands:** You've never heard about **Paul Vunak**, but the SEALs, FBI, CIA and a dozen police department SWAT teams have. He is without question one of the most respected — and *dangerous* — men in the world at hand- to-hand combat — teaching it, and using it. For over 20 years he's been mixing it up with every sort of fighting "expert" you can imagine... on the street, "in the clutch", and in thousands of situations where his life was absolutely on the line.

The U.S. Navy SEALs brought Paul in to teach them his unique system after an exhaustive worldwide search for the *best* hand-to-hand combat system in existence. Paul didn't ask them, mind you... **they** asked **him**. That's how serious Paul's reputation is in the world of real-life warfare. The SEALs, you probably know, are flat-out the most deadly-efficient soldiers on the planet. They

Tactical Response Solutions



won't even *consider* a fighting system — especially a hand-to-hand one — unless it can be taught quickly and used with **100% effectiveness, 100% of the time.**

### **These Professional Soldiers Know If Their Training Fails, They Will Die In Combat!**

That's why the **SEALS** love Paul's system. It incorporates real-life fighting tools no other system has; yet it can be mastered in an astonishingly short time. These soldiers have to spend most of their training time getting in shape, learning complex weapons, and studying top secret military operations. They simply do not have the time to bang around in dojos learning complicated martial arts like karate or Tae Kwan do.

In fact, if you talk to a **SEAL** about martial arts, he'll *laugh* at you. They know it can take *10 years* to become a black belt in any given discipline... and even then, your average YMCA-trained boxer will still dismantle your ass in about 10 seconds!

Most of these super-elite soldiers have black belts in a martial art (sometimes three or four)... but they don't even *consider* using any of it. All that fancy kicking and hacking may look scary, but it doesn't work on the battle field... or in the street.

It simply doesn't work.

**Imagine this:** You're a **SEAL** out in the action; you've just crawled through miles of dense jungle, you haven't eaten for three days, you're dehydrated, sick from dysentery, wounded in two places, out of ammo, and carrying a sixty-pound pack.

You *ain't* gonna rely on a Hollywood spinning round-house kick when the enemy ambushes you. That's not the way real fighting happens. And that's why Paul Vunak's "simplified" hand-to-hand system is so treasured by the soldiers and police and federal agents who need to *rely* on it.

\* **There are no complicated moves!** In fact, in Paul's "basic" system, there are *only 8 moves total!* And all of them are unbelievably effective, and all can be learned and *mastered* in only a matter of hours.

\* **You don't have to be quick, or coordinated, or even in decent physical shape!** All the deadly power comes from extensions of the way your body *naturally* moves. This is called your "gross motor skills" — the same simple movements you use to walk across the room, to scratch your ear, or to step into a car. (I've seen 5-year-old kids who still run funny take down bullies twice their size and age... and little old ladies with limps cancel out young violent men!)

\* **You don't need to train constantly to become a master of this system!** The **SEALS**, the cops, the agents... *none* of them have time to waste in training. Yet they feel confident using Paul's system even after a *single lesson!* (As you will, too!)

\* **Plus, just as importantly, there is no formality, no religious nonsense or bowing or wearing odd uniforms in this system!** It is

*not* martial arts — it is a simplified fighting system that goes *beyond* the street- smarts any martial art could ever offer you!

So how did Paul come up with this amazing fighting system? First of all, he's very well-known in the martial art field. He studied with the legendary **Dan Ionsanto** — original partner of martial art film star **Bruce Lee** ("Enter The Dragon") in the art of Jeet Kune Do. You probably haven't heard of this strange fighting art, but nearly every karate magazine devotes dozens of pages to it. It isn't really an ancient art in itself, like Kenpo or Kung Fu — instead, this Jeet Kune Do is sort of a "greatest hits" method of all the best parts of *all* the martial arts. Bruce and Dan and Paul have been copied (mostly unsuccessfully) by thousands of "wannabe" martial art experts. Yet only Paul "walks the walk" of a true seasoned street-fighter, and is absolutely *idolized* by the "karate crowd" for his warrior life-style.

Paul — who is the internationally-acknowledged master of Jeet Kune Do, and considered the man who went on where the more famous Bruce Lee left off — had *only one rule* when choosing the moves he would incorporate into his "simplified" hand-to-hand system:

### **It Had To Work 100% Of The Time In Actual Street Fights... Where There Are No Rules!**

Paul has proved, over and over again with his own blood (and life) on the line, that his basic system can help anyone defeat even the most brutal, huge and insane street fighter in hand-to-hand combat.

It's not a game to Paul. It's not a game for the soldiers and cops who have to use his system to save their lives. And it won't be a game for you, once you've seen for yourself how easily you can incorporate this amazing system into your own life.

**Listen:** In spite of his efficiency at fighting, Paul Vunak is one of the most compassionate men I've ever met. And he absolutely agrees with me that it's a crime so many good people are walking around afraid in their own neighborhoods — afraid of being attacked, afraid that their girlfriends or wives and kids will be assaulted, or kidnapped, or worse. Paul has a lot of people close to him; he knows what it's like to fear for the safety of loved ones.

That's why he has volunteered to bring his basic fighting system to the public. You should know that he is taking an *enormous risk* in doing this — his job with the Navy **SEALS** is important to him...

But Paul doesn't care. He knows his simplified system will absolutely mean the difference between life and death for a lot of people who need it — people, like you...

### **Who Still Remember When A Civilized Man Was Responsible For His Own Safety!**

Paul has just one serious request. He wants every precaution taken to keep this important fighting system out of the hands of felons and "suspicious" types. And that's my job — that's

why I'm being almost overly-paranoid about who I let see this stuff. As much as is humanly possible, I intend to keep this away from the criminals out there... while at the same time giving the advantages this system offers to as many of the "good" people as I can reach. But, honestly, I don't know how long I will be allowed to offer Paul's system.

### **I Don't Want Any More "Good Guys" Hurt Because They Didn't Have Any Of These Simple Street Fighting Skills!**

At first we were planning to go from city to city doing seminars, spreading a slow wake of confidence among people as we traveled. But that would take too long, and in the end we still wouldn't reach everyone who needs this crucial survival information. No — we had to find a way to get this stuff into the hands of every deserving person *as quickly as we could.*

What we did was, I think, brilliant. We decided to *video-tape* an entire "teaching course" with Paul, and get it to a pre-selected number of people through the mail, all at once. Believe me, this is no ordinary video — instead, it's a genuine **breakthrough** in training technique... even better than what many of the cops and soldiers got during their own initial training!

**Here's what you get:** Paul Vunak went into a San Diego film studio for a week and allowed us to produce the most incredible video package you've ever seen. We were able to take that week's worth of shooting and "distill" it down to just *one* video — that's how simple Paul's system is. This single video is all you'll need to be able to learn (and master) his entire basic "simplified" hand-to-hand street fighting system!

This is the most intense and enlightening hour you'll spend in front of a T.V.! We spent months of preparation for the shoot, and spent about ten times more money in production than we'd planned on — but we're not complaining. This video surpasses all of our wildest dreams. You see, we've all seen about a thousand of the *other* videos out there — you can pick up any martial art magazine and see twenty ads a month for the latest fad among karate "experts". But they're all a huge waste of time, shot with "Uncle Ernie's" hand-held camcorder and without a second thought given to **teaching** you anything. All you get is a long, boring home video of a guy showing off his air punches and spinning kicks, or of some weird seminar where you had to *be there* to get anything of value.

We went the *other* way — using **3 cameras** on Paul and the action at all times. So you get the *best* shot to see what's happening, then get it again from a different angle... and then get it *again* in slow motion, with everything described and broken down into its simplest and most easily-learned form.

### **The way we shot this video... You Might As Well Be In The Same Room With Paul, Getting "Inside" Advice And A Dissection Of Moves Most Soldiers Never See During Training!**

Paul has absolutely dedicated himself to teaching you *everything* you need to know...



and to do it so you can come away from your **first viewing** with enough powerful know-how and new skills to increase your naturally fighting ability by 200%... instantly! This is the equivalent of having 8 personal, super-intense lessons all recorded just for you... by the most *respected* hand-to-hand fighter on the planet!

Even better, Paul took the time to show you clear (and exciting) **real-life examples** of how to handle situations in a crowded bar, in a recreation

**“...the SEALS love Paul’s system. It incorporates real-life fighting tools no other system has; yet it can be mastered in an astonishingly short time.”**

room, and in the street. These “extra” situational learning tools remove any doubt you may have as to how to use your new skill in the real world.

→ **You’ll learn** how to handle two attackers at once — with a one-two natural him-to-him-back-to-him-and-out of danger move that allows your body to act the way it *naturally* wants to.

→ **You’ll learn** the difference between easily-applied “shock” moves, which set up an attacker for you to finish off when you choose to, and even-simpler “clincher” moves — the ones that will *instantly* end any fight the second you deliver them.

→ **You’ll learn** exactly why the “joint manipulation” and difficult kicks of most martial arts don’t work in real life situations — and why, once you know the simple moves of instantly ending a fight anyway, you don’t even *need* to know anything else! (A veteran cop once told me how sad it always is to see the rookies fresh out of the academy try to use their fancy karate moves on a drug-crazed maniac or a drunk bully — only to get their heads cracked open while the criminal gets away, laughing. That’s why the veteran is so happy he learned the **real** way to end any fight from Paul.)

And, of course, you’ll also learn the main secret of this system’s popularity with professional soldiers: it’s easily learned, easily remembered, and most importantly, easily *used*.

#### **Here’s what else you’ll discover in this amazing video:**

- \* The single most important move you can make in any altercation — it’s what your body *wants* to do, but what *most* people panic about and refuse to allow themselves to do! (Yet it will save your life!)
- \* How to use a simple “cat-like” move to instantly position yourself to deliver the easiest knock-out blow imaginable — a strike so natural your grandmother could pull it off against Mike Tyson!
- \* How to instantly “shut down” an attacker’s testosterone levels, using your body’s own built-in “brick”. (Even a 90 lb. woman

possesses this amazing rock-hard weapon!)

- \* **Why hitting anyone with your fist is silly (even trained boxers bust knuckles that way)... and how to use the 8 “natural weapons” of your body to deliver 5 times the power of a fist with half the risk of injuring yourself!**
- \* When to use the most *simple* strike you’ll ever learn... an unstoppable natural move so effective in ending fights that it’s not allowed

in full-contact karate tournaments! (Instant disqualification — it’s also a move that 99% of the most brutal street fighters you’ll ever encounter have **never seen before... and don’t know how to defend against!**)

- \* **How to use the “hip-swinging secret” soldiers use to drop opponents instantly — no speed or strength required, yet it’s like driving a 160 lb. bar of lead into the bad guy’s belly! (It’s so effective, you don’t even have to come close to hitting your “target” area... even the sloppiest attempt by you will bring him to his knees!)**

\* How to effortlessly “parlay” the same natural force that has ended more professional football players careers than any other... it’s a human’s weakest point during a fight (or before a fight begins), and once you know about it you’ve just increased your ability to defeat a larger man by 200%!

- \* **How to use a super-effective, completely unexpected technique straight out of the “Three Stooges” to cause any attacker to automatically (1) back up, (2) raise his hands in defense, and (3) blink rapidly... all of which instantaneously reverses the tables and makes your attacker suddenly vulnerable to a fight- ending blow you can deliver in your own sweet time.**

\* Why all elite soldiers are given “permission” to use the one street fighter’s Secret Weapon we are all taught from kindergarten *not* to use... and how you can use it to quickly remove yourself from any situation where you have been surprised from behind!

- \* **How to use the other “dirty” street-fighting tool not allowed in any civilized boxing or karate match... because of it’s immediate ability to disorientate and topple your opponent! (It also works when you do it incorrectly!)**

**And more!** Don’t let the idea that a system with “only” 8 basic moves must be too simple to work, either — this isn’t theory, this is the result of a lifetime of experimentation in blood! Everything Paul teaches you was perfected either in the street, or on the battlefield... where

it had to work, or good men would die.

**Listen to what these experts have to say:** “There’s no flare, no garbage, no ceremonial nonsense, no magic. Paul can spend 15 minutes with anyone and make you twice the fighter you were before!” — **Shane Brott**, Black Belt Martial Arts Instructor

“Finally, after 23 years of karate and other martial art styles (including military training), I found a system that works in the real world! Paul, where were you 20 years ago?” — **Paul Iwamoto**, Chicago

“Thanks for a video that the ordinary person who works for a living can actually learn from! I am passing these simple and effective tools along to my wife and children.” — **Rick Manente**, Los Angeles

“Street Safe is the most effective self defense system I have ever come across.” — **CA Narcotics Task Force Commander**, (Name withheld due to security regulations.)

“This (Street Safe) will probably turn the Martial Arts community on its ear... **BRAVO Paul.**” — **Jim Hinesly**, SWAT Team Member, Hostage Negotiator, and member of Sheriff’s Tactical Team.

**Actual SEAL team members are not allowed (by strict Navy regulations) to comment, but in private conversations with me they have said that Paul Vunak’s training system has provided them with the most realistic training they’ve ever had, going back 20 years!**

“Paul has one advantage nobody else has — actual experience in street fighting. Having been in it, he can teach you how to not only survive, but win, even if you aren’t experienced in the street.” — **Rich Chen**, Hawaiian ex-street-fighter

“Listen: Any citizen who leaves the safety of themselves or their family in the hands of any organization, including your local police department, is in for trouble! We all need to take responsibility for our own well being. I feel this video tape will give anybody who watches it immediate tools in self-defense principles that will make you confident. And anyone from the age of 13 to 80 can use these tools!” — **Sgt. Carlos Hernandez**, South Florida Police Tactics Instructor

**That last quote sure puts things in perspective, doesn’t it?** That’s a police officer talking — telling you the days of relying on your local cops for protection are long gone!

Let me tell you something you already know in your heart...

**As A Man,  
It’s More Important Than Ever Before  
To Know How To Defend Yourself!**

And, when your family and loved ones are at risk, you need to know how to take out aggressors with **absolute certainty**. Watching Sly Stallone and John Wayne deliver movie-magic roundhouse punches doesn’t cut it.

You have a **duty**, as a man, to protect your-

Call Toll FREE 1-800-899-8153





self and loved ones like a man. And no amount of philosophical nonsense is ever going to change that fact.

You've seen the headlines — rape is up, assault and murder doesn't even make the front page anymore, and robbers are shooting people even **after** they give up their watches and money (it's a trend the police call "Thrill Killing"). Heck, there are jerks hurting people without *any reason at all!* The rules are gone. You could be attacked inside your home, in the back aisles of a supermarket or theater, waiting in your car at a light, anywhere, anytime, by a growing mob of remorseless scum who *enjoy* demolishing innocent people's health and lives.

But they aren't going to enjoy coming up on you, friend. Not anymore.

### It's Time To Stop Being A Victim, And Learn To Walk Your Streets With Confidence!

Look, I know you don't want to turn into some hardened, mean-eyed killer. That's not what Paul's video is about. But do not doubt that the newfound confidence this information gives you will "leak" into every area of your life. I've seen it happen a thousand times...

- ◆ You'll "carry" yourself in a new way that just says "Don't mess with this guy."
- ◆ People will be extremely pleased to see you smile and be nice to them... and will go far out of their way to be extra nice to you, automatically.
- ◆ Have you ever seen how people treat a man like Sean Connery or Joe Montana when they enter a room? It's not just that they're good-looking... more, it's that these men *reek* of confidence and the lack of fear. You can have that, too.
- ◆ Plus, it has to be mentioned: There's an undeniable *sexual attractiveness* to any man who knows how to look the world in the eye and not flinch. You can't fake it—it's a primal, animal part of us, and when it's there

it shines like a searchlight in your eyes.

**Now, let's be straight about something here:** This is not a magic potion you take to become invulnerable. Use this system only at your own risk, and take responsibility all the way down the line for your actions. You can understand why I have to tell you this — we've gone to an enormous amount of trouble and risk to bring this material to you. We're not talking about playing games here; this is real life. Used correctly, Paul's basic system is without doubt your best first-line defense in a tight spot. You'll be able to "parlay" your learning into a few simple moves that will take down a man twice your size, even as he's assaulting you — and even if he has 10 years of martial arts experience, or a lifetime of street-fighting under his belt! This stuff is that effective.

But it's not fool-proof. Don't be a fool, and for God's sake don't go looking for trouble. That's not what this video is about.

That said, you should know that you will take **absolutely no financial risk** in ordering this video! It could not be simpler for you to get this video, watch it at your leisure, and decide in your own sweet time whether it's everything we have told you it is. In fact, you get an almost ridiculously-generous...

### 100% No-Questions-Asked Money-Back Guarantee!

If you aren't convinced, after owning this video for **3 entire months**, that it's the real thing, just send it back to us for a complete refund of your purchase price. You'll get no hassle from me or anyone else... in fact, I will *personally* make sure you are sent your refund by return mail. Heck, you don't even *need* a reason to send it back — I trust your judgement. Like I said, I'm just trying to get this info into the hands of as many "good guys" as I can... *while I can*.

**Here's how to order:** We've set up a special phone line for you — all you need to do is call **1-800-899-8153** and tell the person who answers you want the "Street Safe Code 45-X"

video package, and use your credit card. That's a toll-free call, and won't cost you a cent. Or, you can fill out the special Order Form below and mail it with your check to:

**Tactical Response Solutions  
2945 S. Mooney Blvd. • Dept. 45-X  
Visalia, CA 93277**

That's all there is to it — and when you use your special "code", your video will be *shipped out by return mail!* The price for this video is dirt-cheap, too — in fact, at just \$37 plus \$2 shipping and handling (total: \$39), it's *less* than you'd pay for *one* lousy personal lesson in most karate schools... where at *most* you'd learn how to bow and assume some silly stance that will fool no one!

This really *is* a great offer — because it's the real thing, because your life will change immediately for the better... and because you risk *nothing* by giving the video a "test run" on your own T.V. set.

**Don't put this off** — *remember, there's a very real and very serious chance this information won't be allowed out to the public for very long!* And if you don't order right away, you may never see this offer again, ever. Don't let that happen — you stand to lose *nothing*, and yet what you can **gain** is more important to living well in this world than *any* other skill you'll ever learn!

Sincerely,



R. L. Horine  
President, T.R.S.

**P.S.** One thing — It's *very* important. I have a few copies here of a hot new special report, and I want to send it to you, absolutely **FREE**. It's called *Close Quarters Gun Disarmament*, and it's written by Randy Wanner, chief instructor at a national institute that *exclusively* teaches FBI, DEA, SWAT and other specialized units... but *never* civilians! In fact, **this report was never intended for civilian eyes** — Randy has only agreed to let me give this to carefully selected people who have been cleared to receive our *Street Safe* video.

The information in this hot report has **already saved the lives of officers on duty** — it's a revolutionary technique that allows you a 91% chance of disarming an assailant without getting shot... and with the increase in armed robbery in the U.S., *where people are shot even when they cooperate*, this report could absolutely save your life.

It's yours **FREE** when you get the video... and you can **KEEP** it even if you decide later to return the video package!

[**WARNING:** This is **NOT** the disarmament technique currently being taught by some horribly misinformed "experts" out there — *any* technique you see *advertised* for the public has **not** been cleared by the institute, and is *dangerously* ineffective! No matter what you do, please do **not** take advice from "experts" with no experience in real-life armed situations!]

For The Fastest Service Use Your Credit Card And Call Toll-FREE

**1-800-899-8153** (Ask For Department 45-X)

Priority Order Form For **SOLDIER OF FORTUNE** Readers Only!

**YES!** I want to take advantage of this incredible opportunity while it's still available... I'm ready to take responsibility for my own safety and the safety of my family! I understand I have an overly-generous **3-Month No Questions Asked 100% Guarantee:** If after viewing this video for three months, I am unsatisfied for any reason at all, I can simply return it for a **full refund** of my purchase price. That means I can decide for myself if this really is the most amazing self-defense self-taught course ever created. It's a fabulous deal, and I don't risk a dime by ordering! So please, rush it to me by return mail!

→ \_\_\_\_\_ By initialing this line, I am stating that I am over 18 years of age and that I have never been convicted of a felony. I also state that I will use the information contained in Street Safe in a defensive situation only. I accept sole responsibility for my actions as an adult.

I prefer to pay by credit card. Please charge my:

Visa  MasterCard  AmEx  Discover

Enclosed is my check (payable to TRS), for \$39.

Please rush my Street Safe video to:

CARD# \_\_\_\_\_

NAME \_\_\_\_\_

EXPIRES: \_\_\_\_\_

ADDRESS \_\_\_\_\_

SIGNATURE \_\_\_\_\_

CITY \_\_\_\_\_ ST \_\_\_\_\_ ZIP \_\_\_\_\_

**Tactical Response Solutions • 2945 S. Mooney Blvd. Dept. 45-X • Visalia, CA 93277**

CA & VA residents add appropriate sales tax. Rush shipping available for additional charges. Call (209) 732-5317 for additional information.



Tactical Response Solutions

# ADVENTURE QUARTERMASTER

## PLENTY OF POWER

If you read *SOF*, you probably spend considerable time far from service stations and power lines. Do you drive an old Corn Binder with a stick shift and park on a hill, just in case? Or does your off-road rig have an automatic tranny, in which case a dead battery means you break in that new pair of boots and hope you find water? Or, if born wealthy and you always drive quality iron and keep it in top shape — at your mountain sanctuary, or getting to it — do you need to run lights, charge some poor-boy's battery, or use various electric hand tools?

Ah-hah! *Have we got the goodie for you!* (Pardon the enthusiasm, but you know how we react to innovative, practical engineering when we find it.) Active Technologies Inc. of Alamogordo, New Mexico, has developed the "Lightning" 12/115V DC generator that weighs in at only 15 pounds, yet will deliver 55 amps at 12V or nearly 700 watts at 115V. It will charge an auto battery in minutes, run 12- or 115-volt lighting systems, power 12V pumps and tools, and operate electric hand tools having 115V AC/DC universal (brush-type) motors, such as drills and saws. We charged a battery, jumped a 12V winch, operated a 12V pump, strung together half a dozen 100W lights, whacked up a perfectly good sheet of half-inch plywood with a Skill saw, crosscut and (just to see if we could do it) ripped a pine 2x4, and for a finale fired up a 12V chain saw designed to

work off a battery — and cut better than a half-cord of green maple. The Lightning handled it all without a grunt except the chain saw, but when we hooked the gen set to a battery as a surge demand reservoir and drew from that, we could have cut forever.

The Lightning is compact, lightweight, and not over-powered but has enough guts to do the

things you'd want to do. You could hide it in a bread box; you'll have room in any vehicle, but pack it for access since this is a goodie you'll use when camping, fishing, hunting, prospecting, spelunking or doing whatever is your favorite boonie pursuit.

The makers call this trim little rig a "miniature" generator ... but big *is* as big *does*. Also available in 24/115V. Neat gear. Money-back guarantee. ATI Power Products, Dept. SOF, 1117 La Velle Road, Alamogordo, NM 88310; phone: 505-437-0021.

## NOW MAY BE THE TIME

Of various methods used to squirrel away guns, ammo, gear, chow, medical supplies and your entire collection of *SOF*, the heavy plastic tube caches may well be the best. Unfortunately, we hadn't run across any that would take either our favorite M16 clone fully assembled and/or all

our *SOF* back issues. Now, that's changed.

NIC Law Enforcement Supply is offering the *Groundhog Subterranean Weapons Safe* in an oversized 10x58 inches (4554 cubic inches of stowage) for only \$94.95 (plus \$15 UPS to the Lower 48), or in 8x58 inches at \$59.95 (plus \$10 UPS). Each Groundhog comes



with a desiccant pack, full instructions and sealing options (with a technical assistance number) and NIC's latest catalog of personal and professional security and privacy products. Order from NIC Inc., Dept. SOF, 500 Flournoy Lucas Road, Building 3, Shreveport, LA 71106; phone: 318-688-1367; fax: 318-688-1367.

## IN THE BAG

For fail-safe protection inside a cache container, consider the Milstor super long-term firearm storage system, comprising multi-layered water-and vapor-proof, tear-resistant bags of hermetically sealed aluminized plastic and Tyvek. Milspec, the kits include a volatile anticorrosion insert and two desiccant packs, plus instructions. The generous 60X12-inch bag is cut to fit, then sealed; scraps will make pistol/ammo/instrument bags. A firearm can be expected to stay fresh for decades. \$15 per kit, \$40 for three kits, postpaid from Milstor, Dept. SOF, 1331 W. 135th Drive, Westminster, CO 80234. ✕

## KILLING ZONE

### A Professional's Guide to Preparing or Preventing Ambushes

by Gary Stubblefield and Mark Monday

In today's world, a thorough knowledge of the principles and techniques of the ambush and counterambush has become a life-and-death matter for everyone: bankers, corporate executives, soldiers, government officials, even tourists. In *Killing Zone*, the authors provide you with this vital knowledge in a three-pronged approach that: 1) explains in detail how to plan, launch or prevent an ambush, 2) applies these ambush principles in 60+ special situations ranging from riverine attacks to car bomb ambushes, and 3) analyzes more than 40 actual ambushes in such global hot spots as Vietnam, Northern Ireland, Lebanon, Colombia, Egypt and South Africa, and identifies why the ambushes succeeded or failed. Whether your need is to destroy the enemy by quick shock action, prolong the war and ultimately win by attrition or protect yourself against terrorists who attack on busy downtown streets and well-traveled suburban roads, *Killing Zone* is for you. 5 1/2 x 8 1/2, softcover, illus., 264 pp. **\$25.00**

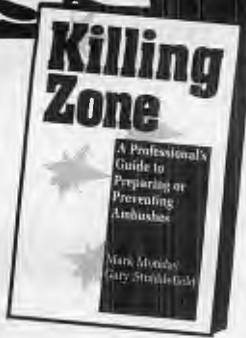

#### AMERICAN SWORDS AND SWORD MAKERS

by Richard Bezdek  
This is the first book ever to span the complete history of American swords, sword makers and sword dealers from Colonial times to the present. More than 200 exquisite photos of important cavalry, infantry, artillery and naval swords and the most complete bibliography in print on swords and sword makers make this the definitive volume for collectors and historians. 8 1/2 x 11, hardcover, photos, illus., 664 pp. **\$79.95**



#### THE 100 GREATEST COMBAT PISTOLS

Hands-On Tests and Evaluations of Handguns from Around the World  
by T.J. Mullin  
This is a remarkable evaluation of the best, worst and most surprising combat pistols from the military arsenals of 25 countries. Find out which handguns did best in real-life combat, where they are most likely to turn up, how to match modern ammo with vintage guns and much more. 8 1/2 x 11, softcover, 400+ photos, 424 pp. **\$40.00**



#### SEAL SNIPER TRAINING PROGRAM

This highly sought manual - until now available only to this elite cadre of specially trained SEALs - contains the complete program by which SEAL snipers train, equip and operate. Included are precise instructions and exclusive, clear photos for target sighting, aiming, trigger control, aircraft takedown, range estimation, helo insertion, ship boarding, stalking, marksmanship and more. 8 1/2 x 11, softcover, photos, illus. 320 pp. **\$30.00**

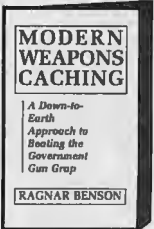

#### MODERN WEAPONS CACHING

A Down-to-Earth Approach to Beating the Government Gun Grab  
by Ragnar Benson  
The time to prepare is now. In the race against the firearm roundup in the U.S., gun owners who refuse to give up the freedoms that are their birthright must take their weapons underground—bury them—before it's too late. Ragnar will show you how to do it right. 5 1/2 x 8 1/2, softcover, photos, 104 pp. **\$14.00**



#### USING OFFSHORE HAVENS FOR PRIVACY AND PROFITS

by Adam Starchild  
In the U.S. our lives have become transparent to nosy, greedy government agencies. That's why there is a growing flight of U.S. capital abroad to safer, more inflationproof, investment-friendly countries. Using layman's terms, Adam Starchild walks you through the reasons to invest overseas, ways to do it and where to entrust your money. 5 1/2 x 8 1/2, softcover, 160 pp. **\$15.00**



#### CARLOS HATHCOCK: MARINE SNIPER

War Stories and Tactical Tips from the Master Sniper with Carlos Hathcock  
The most accomplished sniper of the Vietnam War and the founder of the U.S.M.C. sniper school tells in his own words how snipers out-think and outshoot their prey. In this entertaining and informative video, Hathcock talks about observation, target selection, shot placement and much more. Color, approx. 55 min., VHS only. **\$29.95**



#### GET EVEN

The Complete Book of Dirty Tricks  
by George Hayduke  
A hilarious overview of the methods people use to get even with big business, government and enemies. These dirty tricks range from the simple to the elaborate, including more sophisticated schemes devised by CIA and Mafia members and political dirty tricksters. For entertainment only. 5 1/2 x 8 1/2, hardcover, 208 pp. **\$19.95**

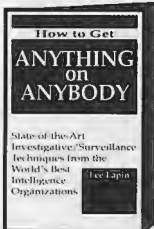

#### HOW TO GET ANYTHING ON ANYBODY

by Lee Lapin  
Get the goods on others with this encyclopedia of advanced investigative and surveillance techniques. Here are expert ways to secretly bug any target! Info on lock-pick technology, how polygraphs and voice lie detectors can be tricked and much more, including more than 100 sources for spy equipment. 8 1/2 x 11, softcover, illus., 272 pp. **\$30.00**



#### FUGITIVE

How to Run, Hide, and Survive  
by Kenn Abaygo  
If you're serious about going on the lam, this book may just save your life. Learn to build an evasion shelter, erect path guards, lose a pack of tracking dogs, enter the "Network" of people willing to assist evaders, apply natural camouflage and utilize primitive first aid skills. This unique manual exposes you to possibilities you never even considered. 5 1/2 x 8 1/2, softcover, 96 pp. **\$12.00**



#### U.S. NAVY SEAL COMBAT MANUAL

One of the rarest FMs in the field of military collecting, with special emphasis on underwater demolition techniques and explosives. Equipment and tactics employed by this elite fighting force are covered, as are SEAL weapons, communications, diving, infiltration and exfiltration, survival and more. 8 1/2 x 11, soft-cover, photos, illus., 240 pp. **\$19.95**

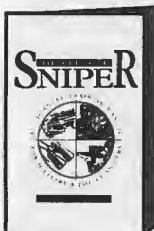

#### THE ULTIMATE SNIPER

An Advanced Training Manual for Military and Police Snipers  
by Maj. John L. Plaster, USAR (Ret.)  
This highly readable and extremely valuable training book covers the practical, field-tested details of sniping's three great skill areas - marksmanship, fieldcraft and tactics. Rifles, scopes, ballistics, target detection, stalking, hides, camo, countersniping, special ops, police vs. military and much more. 8 1/2 x 11, softcover, photos, illus. 464 pp. **\$39.95**



#### BATTLE BLADES

A Professional's Guide to Combat/Fighting Knives  
by Greg Walker  
SF veteran Greg Walker takes the guesswork out of combat blades in this thorough evaluation of daggers, switchblades, utilities, bowies and hideouts. He examines legendary blades from Randall, Gerber and Al Mar, as well as the latest from up-and-coming makers. Includes selection, carry, use, care, legalities and more. 8 1/2 x 11, hardcover, photos, illus., 168 pp. **\$30.00**



#### ULTIMATE SNIPER: THE VIDEO

with John Plaster & Carlos Hathcock  
Learn the art of sniping from two masters. Maj. John Plaster instructs you in all areas of sniping fieldcraft, marksmanship and tactics, and famed USMC sniper Carlos Hathcock recounts some of the field-tested tactics he used to rack up 93 confirmed kills in Vietnam. Covers optics, weapons, shooting drills, cammo, stalking, hides, countersniping, range and wind estimation and more. Color, approx. 90 min., VHS only. **\$59.95**



#### THE SURVIVAL RETREAT

A Total Plan for Retreat Defense  
by Ragnar Benson  
Win the battles of defending your retreat by avoiding them! Learn how to harden your city or rural refuge by locating it well and disguising it. "The best defense is obscurity, unobtrusiveness and silence," Benson writes. Chapters are Who Is the Enemy?, What If It Comes to a Fight?, Beyond Firepower and more. 5 1/2 x 8 1/2, softcover, photos, 136 pp. **\$18.00**



#### THE MEN BEHIND THE LEGEND

This exciting video of all-new action footage features the most famous SEAL commanders of all time and their pivotal roles in the development of the Teams: Doug Fane and the first frogmen; Roy Boehm and the guerrillas of Vietnam; Dick Marcinko and his elite counterterrorists; and Tom Katana and the ultramodern SEAL warriors of today. If you see one film on Navy SEALs, this should be it! Color, approx. 70 min., VHS only. **\$39.95**

## WANTED

ORIGINAL MANUSCRIPTS ON WEAPONRY, MILITARY SCIENCE, SELF-DEFENSE, PERSONAL FREEDOM AND RELATED SUBJECTS. SEND A COPY OF THE MANUSCRIPT TO:  
PALADIN PRESS, P.O. BOX 1307, BOULDER, COLORADO 80306.

(Videotapes are nonreturnable. Damaged tapes will be replaced.)

MONEY-BACK GUARANTEE • DEALER INQUIRIES INVITED • RESPONSE CODE: 4JS

# OTHER FASCINATING TITLES

## REVENGE & HUMOR

- Make 'em Pay! Ultimate Revenge Techniques from the Master Trickster..... \$ 19.95
- Your Revenge Is in the Mail ..... 9.95
- High-Tech Harrassment:
  - How to Get Even With Anybody, Anytime ..... 19.95
- Forgive? Forget It!..... 19.95
- The Joy of Cold Revenge..... 10.00
- Get Even: The Video of Dirty Tricks (video) ..... 19.95
- Get Even 2: More Dirty Tricks From the Master of Revenge ..... 19.95
- The Power of Positive Revenge ..... 19.95
- Make My Day! Hayduke's Best Revenge
  - Techniques for the Punks in Your Life ..... 19.95
- Techniques of Harassment..... 19.95
- Care & Feeding of Tenants ..... 8.95
- Up Yours! Guide to Advanced Revenge Techniques ..... 19.95
- Mad as Hell: A Master Tome of Revengemanship..... 19.95
- The Revenge Book ..... 10.00
- Tenant's Revenge: How to Tame Your Landlord ..... 9.95
- Screw Unto Others:
  - Revenge Tactics For All Occasions ..... 19.95

## PERSONAL FREEDOM & MONEY

- Preemployment Integrity Testing..... \$ 12.00
- The Outlaw Reports ..... 25.00
- Street-Smart Survival ..... 15.00
- Financial Investment Expertise: The Complete Guide to Terms, Definitions, and Winning Strategies... 21.95
- Filmflam Man: How Con Games Work ..... 19.95
- Electronic Fund Transfer Systems Fraud..... 15.00
- Save Your License ..... 14.95
- The Armchair Millionaire ..... 10.00
- Disguise Techniques: Fool All of the People
  - Some of the Time ..... 8.00
- Credit Mechanic ..... 10.00
- How to Hide Anything..... 12.00

## ESPIONAGE & INVESTIGATIONS

- Don't Bug Me: The Latest High-Tech Spy Methods..... \$ 19.95
- How to Avoid Electronic Eavesdropping and Privacy Invasion ..... 12.95
- Undercover Operations: A Manual for the Private Investigator ..... 10.00
- Detective's Private Investigation Training Manual..... 14.95
- Obtaining Your Private Investigator's License..... 10.00
- Practical Guide for Private Investigators ..... 12.00
- How to Investigate by Computer ..... 35.00
- SpyGame ..... 35.00
- SOE Secret Operations Manual ..... 20.00
- Surveillance Countermeasures ..... 20.00

## WEAPONS

- AR-15/M16 Super Systems..... \$ 19.95
- AR-7 Super Systems..... 15.00
- The Gatling Gun: 19th Century Machine Gun to 21st Century Vulcan..... 29.95
- The AR-15/M16: A Practical Guide ..... 16.95
- The Ruger .22 Automatic Pistol:
  - Standard/Mark I/Mark II Series..... 12.00
- The Combat Shotgun and Submachine Gun:
  - A Special Weapons Analysis..... 19.95
- Assault Pistols, Rifles and Submachine Guns ..... 21.95
- The Shotgun in Combat ..... 10.00
- Shooting to Live ..... 10.00
- Home Workshop Guns for Defense and Resistance:
  - Vol. II, The Handgun..... 14.00
- The Complete Book of Combat Handgunning ..... 16.95
- German Machine Guns ..... 49.95
- Blowguns: The Breath of Death ..... 14.00
- Streetsweepers: The Complete Book of
  - Combat Shotguns..... 17.95
- Glock: The New Wave in Combat Handguns ..... 25.00
- The Complete AR-15/M16 Sourcebook:
  - What Every Shooter Needs to Know ..... 35.00

## ACTION CAREERS

- Unrepentant Sinner ..... \$ 17.95
- Keep 'em Alive ..... 12.00
- Manual of the Mercenary Soldier: A Guide to Mercenary War, Money and Adventure ..... 24.95
- Dead Clients Don't Pay ..... 12.00
- Expatriate's Employment Handbook..... 15.00
- Bounty Hunter..... 12.00
- Bail Enforcer: The Advanced Bounty Hunter ..... 16.95

## MILITARY SCIENCE

- Night Fighter's Handbook..... \$ 10.00
- Long-Range Patrol Operations: Reconnaissance, Combat, and Special Operations ..... 19.95
- Communications Equipment
  - of the German Army: 1933-1945..... 30.00
- Radio Equipment of the Third Reich: 1933-1945 ..... 25.00
- SEALs: UDT/SEAL Operations in Vietnam ..... 26.95
- U.S. Army Special Forces Medical Handbook ..... 22.95
- Improvised Radio Jamming Techniques ..... 19.95
- The Scout..... 10.00
- Project Delta:
  - Special Forces Vietnam Recon Manual ..... 8.00
- Special Forces Handbook ..... 10.00
- Special Forces Air Operations ..... 15.00
- Special Forces Waterborne Operations ..... 15.00
- Special Forces Operational Techniques ..... 22.00
- Soldiers on Skis:
  - A Pictorial Memoir of the 10th Mountain Division... 50.00

## SURVIVAL

- Ragnar's Ten Best Traps: And a Few Others that Are
  - Damn Good, Too ..... \$ 10.00
- Survivalist's Medicine Chest..... 10.00
- Survival: A Manual That Could Save Your Life ..... 18.00
- The Trapper's Bible:
  - Traps, Snares, and Pathguards ..... 8.00
- Live Off the Land in the City and Country ..... 29.95
- Combat Survival ..... 18.95
- The Good Booze Recipe and Cookbook..... 8.00
- Ditch Medicine:
  - Advanced Field Procedures for Emergencies... 25.00
- The Survival Retreat:
  - A Total Plan for Retreat Defense ..... 8.00

## SNIPING

- The Complete Book of U.S. Sniping ..... \$ 39.95
- The German Sniper: 1914-1945 ..... 60.00
- Modern Sniper Rifles ..... 16.95
- U.S. Marine Corps Sniping..... 14.95
- U.S. Marine Corps Scout/Sniper:
  - World War II and Korea ..... 39.95

## KNIVES & KNIFE FIGHTING

- The Complete Bladesmith: Forging Your Way to Perfection ..... \$ 30.00
- Knives, Knife Fighting, & Related Hassles..... 12.00
- Randall Made Knives: The History of the Man and the Blades ..... 50.00
- Switchblade: The Ace of Blades ..... 12.00
- Winning a Street Knife Fight (video) ..... 29.95
- Surviving a Street Knife Fight (video) ..... 29.95

## SELF-DEFENSE

- Commando Fighting Techniques..... \$ 12.00
- The Death Dealer's Manual ..... 12.00
- Principles of Personal Defense ..... 10.00
- Get Tough..... 19.95
- No Second Chance! Disarming the Armed Assailant ..... 14.00
- Violence, Blunders, and Fractured Jaws: Advanced Awareness Techniques and Street Etiquette..... 22.95
- Fight for Your Life! The Secrets of Street Fighting .... 10.00
- 101 Sucker Punches ..... 10.00
- Pool Cues, Beer Bottles, and Baseball Bats ..... 12.00

## COMBAT SHOOTING

- Handgun Stopping Power: The Definitive Study .... \$ 39.95
- Instinct Combat Shooting ..... 12.00
- How to Become a Master Handgunner:
  - The Mechanics of X-Count Shooting..... 10.00
- Quick or Dead ..... 25.00
- Handgun Muzzle Flash Tests:
  - How Police Cartridges Compare ..... 20.00

## POLICE SCIENCE

- SWAT Training and Employment ..... \$ 14.00
- Streetwork: The Way to Police Officer
  - Safety and Survival ..... 19.95
- D.E.A. Narcotics Investigator's Manual..... 50.00
- Crime Scene Search and Physical
  - Evidence Handbook ..... 16.00
- The S.W.A.T. Team Manual..... 20.00
- S.W.A.T. Tactics ..... 12.00
- Mug Shots ..... 16.00
- Gangs USA ..... 24.95
- Decoy Ops: Fighting Street Crime Undercover ..... 15.95
- Death Investigator's Handbook: A Field Guide to Crime
  - Scene Processing, Forensic Evaluations, and Investigative Techniques ..... 40.00
- Kill or Get Killed..... 29.95
- Street Cop: Innovative Tactics for
  - Taking Back the Streets..... 20.00
- Riot Control: Materiel and Techniques ..... 29.95
- Police Crowd Control: Risk-Reduction
  - Strategies for Law Enforcement ..... 16.00



**PALADIN PRESS**  
**P.O. BOX 1307-4JS**  
**BOULDER, CO 80306**



**CREDIT CARD ORDERS CALL TOLL FREE 1-800-392-2400**  
 Call 24 hours a day, 7 days a week. Send \$2.00 for 64-page CATALOG of over 600 titles (free with order).

PLEASE SEND ME THE FOLLOWING TITLES:

RESPONSE CODE: 4JS

\_\_\_\_\_

\_\_\_\_\_

\_\_\_\_\_

CHECK/ MONEY ORDER     VISA     MASTERCARD     DISCOVER

CARD# \_\_\_\_\_ EXP. \_\_\_\_\_ SUBTOTAL \_\_\_\_\_

NAME \_\_\_\_\_ PLEASE INCLUDE POSTAGE & HANDLING \$ 4.00

ADDRESS \_\_\_\_\_ TOTAL \_\_\_\_\_

CITY \_\_\_\_\_ STATE \_\_\_\_\_ ZIP \_\_\_\_\_

U.S. Military Spec Design  
**THE BUSHMASTER E2S SERIES. . .**

Civilian Legal!  
**.223 Semi Auto Rifles**

**Manufactured with your lifespan in mind.**

Patent Pending

**NEW!**

**E2 Carbine Dissipator 16"**

Full Site Radius allows full use of the  
New A2 Site System - these can take the heat.  
Your choice of standard or telescoping stock.

**Special**



**P.O.R.\***

E2S - "Shorty"  
11.5"/15.5"

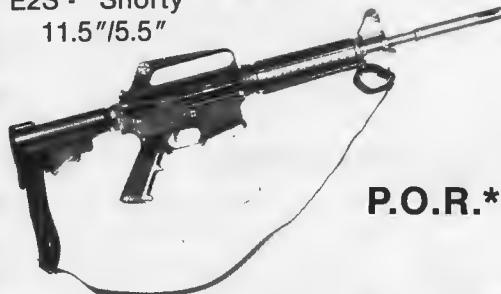

**P.O.R.\***

E2S - 16" Carbine

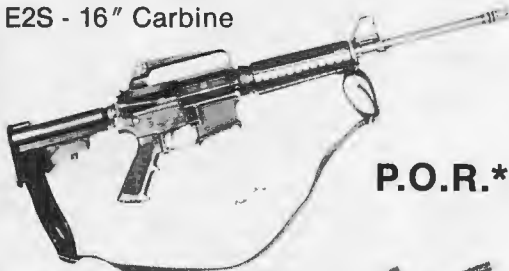

**P.O.R.\***

E2S - 20" Target Model



**P.O.R.\***

Bushmaster Firearms, Inc. has produced quality firearms, spare parts and accessories for the military, police and civilian markets for over 15 years.

Our most recent military contract was for the M16A2 M4 Carbine.

Our answer to the Colt M16A2 is our Bushmaster E2S series of rifles. The E2S is patterned after the M16 and we will customize for your specific requirements and applications.

**\*PRICES ON REQUEST**

**Why shouldn't you be able to purchase what the U.S. Military requires?**

**Features Include:**

- **Full component interchangeability**  
No "matching" upper and lower receivers. All our receivers match and interchange both in fit and color.
- **Chrome lined Spec barrels**  
Complete corrosion resistance in bore and chamber. Chrome is more than twice as hard as barrel steel - doubles barrel life. Lubricity of chrome reduces friction, increases velocity and aids in feeding, extraction and ejection.  
Other chromed surfaces:
  - Firing Pins
  - Inside wear surface of bolt carrier
  - Inside wear surface of bolt carrier key
- **Manganese Phosphate protective finish** on all steel components - barrels, bolt carriers, etc. The latest mil spec - totally anticorrosive - cannot be rusted.
- **Push Pin** breakdown
- **Forged not "cast" Front Site with Bayo Lug.**
- **Upper and Lower Receivers**  
NEW A2 Reinforced Design. Forged 7075T6 Aircraft Quality Aluminum correctly machined for mil spec interchangeability. Hard Anodized Type 3 Class 2. Finally we Dry film lube and bake the upper receivers.

**If you buy ammo by the Box**  
- you can possibly get by  
with something else. . . ,

**If you buy ammo by the CASE**  
- buy a Bushmaster!

See our technical evaluation in:

**Soldier of Fortune's**  
**Fighting Firearms Annual 1992**  
**Titled:**  
**"Bushmaster Makes a Better M16!"**

Distributed by:



Orders: P.O. Box 1479, Windham, Maine 04062

Order by Phone **1-800-998-SWAT**

Order by Fax (207) 892-8068

Inquiries: 999 Roosevelt Trail, Building 3, Windham, Maine 04062

Phone (207) 892-2005

**NEW TOLL FREE! 1-800-998-SWAT**

**ORDERS ONLY**

## Can-Do Cannon

by Peter G. Kokalis  
Photos courtesy LIW

**T**he principal distinction between heavy machine guns and automatic cannons lies in the area of their ammunition. And, it is actually in their respective projectile types where the real difference rests.

Most cannon projectiles are shells, i.e., hollow projectiles which contain explosive material that is initiated by an impact fuze at the target, or at some earlier point during the trajectory, by a time-delay mechanism. Whereas, most heavy machine-gun projectiles are of the solid-ball type with lead or steel cores, which sometimes have hollowed-out areas at the base or nose that contain tracer or incendiary elements, respectively.

This distinction between heavy machine gun and cannon ammunition is somewhat blurred by an early Soviet 12.7x108mm antiaircraft round with a projectile that contained both high explosive and incendiary composition — and by the more recent Norwegian .50 caliber (12.7x99mm), multi-purpose Raufoss ammunition, the bullet of which is filled with a hard core and a loading of RDX explosive.

Some cannon ammunition, such as the 20x82mm round (case length is actually 83.52mm), packaged in a smaller envelope than either the .50 caliber Browning or Soviet 12.7mm



South African GA1 20mm automatic cannon converted to .50 caliber Browning machine gun round reduces training costs and provides combat-proven, armor-piercing ammunition for employment against lightly armored vehicles and boats, while retaining the 20mm round's devastating anti-personnel potential.

cartridges.

South African semi-rimmed, percussion-primed, steel-cased 20x82mm ammunition is available in five types: nose-fuzed High Explosive Incendiary (HEI); High Explosive Incendiary Tracer (HEIT), filled with 107 grains of Hexal P30; base-fuzed Semi Armor Piercing High Explosive Incendiary (SAPHEI), filled with 92 grains of Hexal P18; and both dummy-fuzed Target Practice (TP) and Target Practice Tracer (TPT).

Muzzle velocity of this ammunition is about 2,360 fps (719 m/s). The arming distance of the fuze is 8 meters, minimum. Tracing time of the HEIT and TPT rounds is two seconds, minimum. Soft iron driving bands are used to insure long barrel life and to prevent fouling. The weight of the projectile (or shell), filled and fuzed, is

about 1,690 grains.

This is quite a payload in a small package, and it is significantly superior to .50 caliber ball for antipersonnel applications — because it disperses numerous fragments into an area often referred to as the “effective casualty radius” (the distance from the point of detonation at which a certain percentage of exposed personnel will be casualties).

Without doubt, 20mm guns can wreak awesome destruction upon unprotected troops. There is, in my opinion, no better delivery system for this purpose than the South African GA1, a vastly improved and updated version of the German MG 151/20 aircraft cannon (see “Ma Deuce’s Mother” *SOF* July ‘93).

Reengineered and produced by LIW (Dept. SOF, 368 Selborne Ave., Lyttelton, P.O. Box 7710, Pretoria 0001, Republic of South Africa; phone: 27-12-620-2709, fax: 27-12-620-2407), I have personally witnessed the GA1 — mounted on the Casspir Mk 2 Mine Protected Vehicle (MPV) — employed with deadly effect by *Koevoet* (a police counter-insurgency unit) in the former South-West Africa (now Namibia) on the border with Angola.

The method of operation is roller-locked, short recoil with a cradle-brake



GA1 .50 caliber conversion kit consists of barrel jacket assembly, .50 caliber barrel with integral piston at muzzle, 12.7x99mm bolt head, feed ramp and plastic link inserts.

# STEROIDS

ALTERNATIVES

**ALL PRODUCTS 100% NATURAL  
NO HARMFUL SIDE AFFECTS**

- 1 **DIRENZOZIDE 10 mg** is the most powerful steroid replacement on the market & 100% legal. *World records have been set while using this product!*  
**2 month cycle \$22.50**
- 2 **BORON 10 mg** naturally enhances testosterone levels so you can build muscle *without the harmful side effects of illegal steroids.*  
**3 month cycle \$15.95**
- 3 **GROWTH HORMONE RELEASER G.H.R.X.**  
Releases growth hormone in an abundance like no other. *Works great with Boron.*  
**60 tabs \$21.00**
- 4 **LEGAL STEROL COMPLEX** enhances growth. Allows body to stay pumped longer. Releases growth hormone and *strips away fat!*  
**60 tabs \$19.95**

**LIFETIME 100% MONEY BACK GUARANTEE**

Buy Products 1, 2 & 3 and get #4 FREE. This will enable you to have the most powerful natural anabolic stack on the market.

**ORDER NOW! C.O.D.'S WELCOME**

**1-800-398-6946** Ask for ext. 120

Send Check or M.O. (Add \$4.00 for shipping)

**S&K LABS**

2637 E. ATLANTIC BLVD., SUITE 101.  
POMPANO BEACH, FL 33062

**COD**

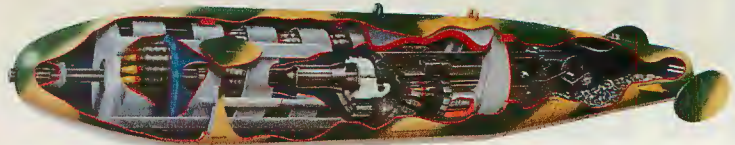

GA1 fixed-wing aircraft gunpod is manufactured from carbon fiber materials and can be mounted on a large number of light aircraft and helicopters. It has a unique 200-round spiral magazine and features an automatic electrical recocking mechanism.

recoil system. Fully automatic with firing from the open-bolt position, the cyclic rate is 650 to 750 rpm. Its salient features are the simplicity of the design, which provides for ease of maintenance and cleaning, its compactness and a relatively light weight. With the barrel, but without a mount, the GA1 weighs only 39 kilograms (approximately 86 pounds), empty. This favorably compares with 84 pounds for the .50 caliber Browning M2 HB machine gun and with 106.5 pounds for the caliber 12.7x108mm Russian Degtyarev Pekhotnyy (DP) Model 38/46

heavy machine gun.

There is only one problem with this successful equation. Defense budgets are shrinking at asymptotic rates and 20mm automatic cannon ammunition is far more expensive than .50 caliber ball — for some countries, far too expensive to conduct the training required to bring troops to combat-ready proficiency levels.

LIW, a major player in the defense industry's international arena, is keenly aware of the downward spiraling status of defense bud-

*Continued on page 68*



Rhodesian #1003

## AT LAST! The SOF Classic Collection!



H & K #1004

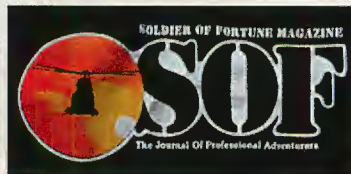

SOF Logo  
Bk #1001



SOF Logo  
W #1002



Polo 50/50  
Bk #1005  
W #1006

Available for a limited time!  
Sizes: M,L,XL,XXL

T-shirts: Only \$12.95  
Polo Shirts: Only \$18.95

Name \_\_\_\_\_  
Address \_\_\_\_\_  
City \_\_\_\_\_  
State \_\_\_\_\_ Zip \_\_\_\_\_

Clip and Mail To: Facets  
576 Aztec Drive  
Boulder, CO 80303

Foreign orders add \$10.00 for Shipping

QTY	ITEM NO.	SIZE	PRICE EA.	TOTAL
*Add \$3.00 for first shirt S&H			Sub Total	
*Add \$1.00 ea. additional shirts S&H			S & H*	
*Add \$1.00 for XXL S&H			3% Sales Tax (Colorado Residents Only)	
MC/VISA <input type="checkbox"/> CK <input type="checkbox"/> MO <input type="checkbox"/>			TOTAL	

# Donovans Airborne All The Way

by **SOF Staff**

**Buffeted by propwash**, 24-year-old Mark Donovan, son of *SOF* Demolitions Editor John Donovan, moved out in jump order with his stick and clambered aboard a rumbling Israeli Arava cargo plane. There was only one thing left to do.

Once airborne the aircraft banked and headed inland; the DZ, located in the middle of dense, double-canopy jungle came into view and the joking tapered off. Men began hooking-up and checking equipment as they jumper-shuffled toward the light of the open door, anticipating their tap-outs: *Fuerte! Fuerte! Fuerte!* (Strong!) Soon the sky exploded in a barrage of billowing round canopies, and the “cherry boys” dangling beneath the open chutes breathed a collective, if momentary, sigh of relief as they rapidly descended to the DZ below.

As anyone who knows the Donovan clan will tell you,



Don't make a water jump dressed like this. John Donovan, who will make his 400th military jump in Vietnam this year, shows off some of his jump wings at last year's *SOF* convention.

parachuting is something of a rite of passage in the family. John spent more than 13 years in the Special Forces and is a U.S. Master Parachutist. He will receive Vietnamese wings at his 400th military jump in Dien Bien Phu this year — adding to an already formidable brass collection that should preclude his ever having to wear a bulletproof vest. Mark's older brother Matt, also a Master Paratrooper, spent eight years in the Special Forces and has jumped in such diverse places as the Dominican Republic, Australia, China, Germany and Honduras, among others.

Living under the shadow of this sky-diving heritage, it was logical for younger brother Mark to want to be part of the airborne legacy, and he enlisted in the Army during the build-up for Operation Desert Shield. Though hoping for a slot at jump school, he was derailed by the quick success of Desert Storm and ended up finishing out his

service in Germany, still a “leg.” It was back stateside as a civilian that he heard about Phoenix Group.

The U.S.-based Phoenix Group operates in conjunction with military parachute schools in Guatemala and Honduras, and gives qualified civilians a taste of what it takes to earn the wings. Led by director Clint Trial, the instructors are all active-duty special forces and include the Honduran *Teson* and the Guatemalan *Kaibil*, aka “Black Hats,” a cadre of accomplished parachute/special forces trainers.

The only airborne school in Guatemala, the *Escuela de Paracaidistas* is a near mirror image of its U.S. model at Fort Benning — except rookies don't need to enlist in the military to participate in the training. Students must complete two-and-a-half weeks of ground school of continuous PT, PLFs and 34-foot tower jumps — and wrap up with five jumps in three days for qualification: two equipment jumps and three “Hollywood” jumps, where students leave packs and weapons behind.

Mark jumped at the chance to attend one of Phoenix's training cycles and quickly became, in one instructor's words, “the best student out there.” As jump week approached the instructors began to realize Mark was on a mission — he was going to catch his wings.

For his efforts, Mark was awarded the “Iron Mike” as distinguished graduate, and wasted no time celebrating his entrance into the “diving dynasty.” The three airborne Donovans quickly made plans to jump together in Hondu-

Continued on page 79



(Left to right): “Nasty legs” Hugh Hilliard and soon-to-be airborne Donovan brothers Mark & Matt ready to board Israeli Arava for final proviso on road to blood wings. Photo: Clint Trial





Is this the future of the Second Amendment? Workers at Kearny Smelter & Refining Co. in Kearny, New Jersey, melt confiscated and "surplus" firearms. Are your guns next? Photo: AP/Wide World

SAVE  
YOUR  
GUNS

# Selling Out The Constitution

## 216 Congressmen Assault Our Right To Bear Arms

by Dwight Swift

**Anyone who has** read American history is familiar with the insightful arguments our Founding Fathers used to craft the legal bedrock of this country. With the brilliance of Washington, Jefferson and Madison in mind, *SOF* thought you might like to read the astute reasoning used by today's members of the U.S. House of Representatives when they voted to restrict the Second Amendment to the Constitution and pass H.R. 4296 "Assault Weapons Ban" on 5 May 1994.

Rep. Robert Menendez, D-N.J.: "Mr. Speaker, today we are each asked a simple question: Do you think we should allow the sale of assault weapons to continue unchecked? Make no mistake, a 'no' vote today means that you think it's just fine to go ahead and keep flooding the streets with these guns by the thousands. A 'no' vote means, 'Yes, I saw the news last night, I saw that child's life was snuffed out by a stray bullet from an UZI. But you know, they are entitled to those UZIs.' Well, Mr. Speaker, I think

most of America says they are not.

"Our country has become a battlefield, and semiautomatic assault weapons have become the armaments of choice. Far too many people have been killed or crippled for us to pretend that these weapons are merely for sportsmen and hunters.

"Today we are asked to decide whether the blood in the streets is simply an acceptable loss in defense of liberty, or an intolerable slaughter of our neighbors and families. Who do you think will thank you for de-

fending this slaughter? — your version of liberty? Say no to the killing. Say no to weapons designed for murder. Say yes to life — vote yes on the assault weapons ban.”

Typical of gun grabbers throughout the country, Rep. Menendez attempts to appeal to sentiment with a speech that’s long on emotion but conspicuous in its lack of facts or specifics.

Rep. Richard Durbin, D-Ill., took a different tack that showed he was not as concerned with disarming law-abiding citizens or addressing crime, as he was with putting gun lobbyists out of work:

“Mr. Speaker, Congress has a choice today on the assault weapons ban. Members of Congress can stand with the gun lobby, or they can stand with the police. The well-funded National Rifle Association lobbyists got up this morning determined to save their jobs by threatening members of Congress that a vote for the weapons ban would endanger their political lives. But thousands of men and women also got up this morning, put their badges on, their police uniforms on and their lives on the line to protect our families and our communities. These policemen are begging Congress to help take these combat weapons off the street and out of the hands of the mentally unstable, the criminally violent, and the drug gangs.

“So, Mr. Speaker, I say to my colleagues, ‘Take your pick, members of Congress. Protect the political lives of gun lobbyists or the lives of policemen across America.’

“History will undoubtedly view today’s debate with incredulity if we fail. A nation awash in violent crime watches as its national legislature cannot bring itself to prohibit 19 of the most dangerous weapons available. Let us hope Congress has the courage today to take this small step toward making American families safer.”

From the misinformed we go straight to the clueless:

Rep. Romano Mazzoli, D-Ky.: “Another argument I have heard is the shrouds and the flash suppressors and the pistol grips and folding stocks, that they are really only cosmetic additions to the weapons. At the full committee I asked that very question of the chairman of the committee,

‘... do they have some substantive facility for the people who would use them for wrong purposes?’ In fact, they do have a use for wrong purposes: You can fire more quickly, you can do more damage with these features than without.”

Rep. James Traficant Jr., D-Ohio: “Congress is getting phone calls. People are saying, ‘Vote no, vote no;’ from good Americans who believe Congress will ultimately take away their guns.

“As a former sheriff, let me remind members today that Congress is getting no phone calls from the graves of victims in cemeteries all over America.

“Mario Andretti cannot drive his Indianapolis 500 race car on the Pennsylvania Turnpike, and you do not need a machine gun with a grenade launcher and a bayonet to kill a rabbit.”

Traficant and Mazzoli missed the point. It is not illegal to possess an Indy race car — only to drive it on the interstate. Grenade launchers and machine guns are already separately regulated; the 19 firearms being banned are semiautomatic rifles identical in function to many hunting arms. We can only puzzle at Rep. Mazzoli and ask him how one can increase the rate of fire of any of the firearms on the ban list by adding a collapsible stock or flash suppressor.

Rep. Butler Derrick, D-S.C.: “These weapons are the macho symbol of lawlessness. More and more the lawless employ them. It is clear what place these weapons have in our society: It is a place of self-destruction.

“Vote to ban these tools of anarchy. If we do not, we enshrine this violence in our culture.”

Rep. Tim Roemer, D-Ind.: “It is unthinkable that in our society, we continue to allow citizens to walk the streets with guns that have grenade

launchers, flash suppressors, and bayonet mounts. What legitimate recreational purpose could these characteristics possibly serve?”

Many felt that unlike offensive, yet protected speech, weapons must have some government-defined redeeming value to fall under constitutional protection; well, the Second Amendment is not about duck hunting or recreational use and there have been no recorded crimes where criminals used rifle-mounted bayonets.

nals used rifle-mounted bayonets.

Rep. John Lewis, D-Ga.: “Mr. Speaker, there is no legitimate reason for any individual to own an UZI, an AK-47 or a TEC-9. These are the vicious instruments of war, the implements of death.”

Rep. John Porter, R-Ill.: “These are weapons with no hunting, sporting, or other legitimate purpose and for which there is no reason for anyone to own except

to aid in the commission of crime.”

Rep. David Skaggs, D-Colo.: “The legislation before us today will begin to take off the streets the most deadly of all firearms — military-style assault weapons designed for no other purpose than to kill human beings quickly, and in large numbers.”

Skaggs’ argument is based on the fallacy that criminals obey the law. Military-style rifles are no more or less deadly than non-military rifles of similar caliber. Semiauto military style firearms are no more designed to kill people than any other semiauto firearm.

Derrick: “Assault weapons are used by criminals, not hunters or sport shooters. The sole purpose of these weapons is to kill a lot of people quickly. What was originally intended for military combat, has now become the weapon of choice for drug dealers and gangs.”



Gun-grabbing guru from New York, Democratic Rep. Charles Schumer led the attack against gun ownership, “... these guns are plainly and simply killing machines. They have no place ... in a civilized society.”

Few criminals pack the bulky, expensive "assault" rifles this legislation seeks to ban, though numerous congresspersons thought they had all the answers — backed up by BATF statistics, no less:

Derrick: "Mr. Speaker, every year the problem of gun violence seems to get worse as more assault weapons find their way into the hands of criminals. It is estimated that there are roughly one million assault weapons in the United States. According to the Bureau of Alcohol, Tobacco, and Firearms, between 1990 and 1993, reports of assault weapons increased by 35%. From 1990 to 1993, the percent of firearms traced that were assault weapons rose from 5.9% to 8.1%. Since studies show that assault weapons make up only 1% of the firearms in circulation, assault weapons are in proportion used more often to commit crimes. In fact, these weapons are 18 times more likely than other guns to be cop-killers, and 16 times more likely to be traced to crime than other firearms."

Rep. Louise Slaughter, D-N.Y.: "Mr. Speaker, whatever the gun advocates say, the facts prove a different story: When a firearm is used for crime, it is 19 times more likely to be an assault weapon than some other type of gun."

Roemer: "Opponents of this bill cite statistics which indicate that assault weapons account for only 1% of the guns in circulation. What they neglect to point out is that this 1% is used for over 8% of criminal activity."

Rep. Rick Lazio, R-N.Y.: "According to the BATF, while semiautomatic weapons comprise only 1% of privately owned guns in America, they account for more than 9% of guns used during a crime and traced."

Rep. Michael Andrews, D-Texas: "Federal statistics show that, al-

though semiautomatic assault weapons account for only 0.5% of privately owned firearms in this country, they are involved in 8.4% of crimes involving firearms. In other words, assault weapons are 17 times more likely to be traced to crimes than conventional firearms."

Rep. Nita Lowey, D-N.Y.: "If only 1% of all guns held by the public are assault weapons, why are they used in 7% of all crimes?"

Rep. Sherwood Boehlert, R-N.Y.: "We are reliably informed that these assault weapons represent nearly 30% of guns traced to organized crime, drug trafficking and crimes involving terrorists."

Rep. Eliot Engel, D-N.Y.: "Polls have shown that 77% of Americans want an assault weapons ban. Violence is in our streets, violence is in our cities and our towns, and yet we sit and wring our hands and do not react to it at all."

Derrick: "Well, 80% of the people in this country want to ban assault weapons."

There also seemed to be interesting thoughts regarding the effectiveness of this bill. Congresspersons seemed to agree that only law-abiding citizens will be affected.

Rep. Walter Tucker III, D-Calif.: "If one or two lives can be saved, Mr. Speaker, then it is certainly worth it. The Constitution is not in jeop-

ardy, but certainly crime and violence can be abated by the passage of this bill."

Roemer: "The simple fact is that we will not completely stop the violence on our streets with this ban. What we are finally doing with this bill is finally taking a definitive stand against violence in our streets and in our schools."

Rep. Don Johnson, D-Ga.: "Mr. Chairman, I support an assault weapons ban because very simply, I believe that it will save lives. Let me be clear, I do not think it will reduce crime in America ... We cannot stop sick individuals from getting guns, but what we can do is make it harder for them to get weapons equipped to fire dozens of shots without reloading."

Rep. William Hughes, D-N.J.: "Mr. Chairman, this issue is about common sense. It is not about eliminating crime because there is nothing we can do to eliminate crime."

Rep. Marilyn Lloyd, D-Tenn.: "After reviewing homicide statistics and seeing these daily incidents involving semiautomatic assault weapons, I cannot justify their existence. I realize that this measure will not eliminate the problem of violence ... but it will create a major obstacle."

Rep. C. W. Young, R-Fla.: "There is no doubt this ban will not prevent all criminal activities, but if it saves the life of one innocent victim ... then this ban is worth enacting today."

If, in Rep. Young's view, saving one innocent life is worth robbing the American people of their right to defend themselves and stand up to tyranny, then we can only hope Young's constituents help him find more suitable employment, preferably overseas.

Then there were those statements that are so asinine we are hard-pressed to offer any logical response. These



Democratic Rep. Butler Derrick from South Carolina: "These weapons are the macho symbol of lawlessness. Vote to ban these tools of anarchy."



Rep. Louise Slaughter, a Democrat from New York, spoke with authority on a topic she obviously knows nothing about: "It is clear why criminals prefer assault weapons. Their rapid rate of fire and random spray make them the most dangerous and fearsome guns around." Unfortunately, few of these so-called "assault" weapons are used by criminals, and semiautos don't spray nor have a rate of fire more rapid than many so-called hunting arms.

gems stand on their own and will hopefully follow their creators around come election time.

Traficant: "Mr. Speaker, I am a former sheriff and let me say this: The Second Amendment to the Constitution makes sure that Americans can bear arms and have the right to protect themselves, but the Constitution never intended for individuals to strap a Stinger missile on their back and then cite the Second Amendment privilege."

Slaughter: "It is clear why criminals prefer assault weapons. Their rapid rate of fire and their random spray make them the most dangerous and fearsome guns around. In just five horrible seconds, an UZI can fire 30 bullets. In the underworld of gang warfare, this destructive power is the key to success."

An UZI submachine gun can do better than that — 50 rounds in five seconds — but full-auto firearms are not what this bill is about. Semiauto firearms fire once each time the trigger is pressed. If Slaughter can fire 30 rounds in 5 seconds (horrible ones or not) with any of the weapons this bill seeks to ban, we'll endorse her reelection.

Rep. Charles Schumer D-N.Y.: "... the whole idea of our bill ... is very simple: To prevent people like Mr. Obremski [a violent criminal] from getting assault weapons. He should be locked up, but if he is not and people like him are not, they should not have assault weapons."

Rep. Edward Markey, D-Mass.: "Mr. Speaker, the Constitution does not permit Americans to own bazookas. It does not permit Americans to own antitank weapons. And it does not permit Americans to own

assault weapons.

"We should ban these weapons, to disarm the criminals and the teenagers in this country that are terrorizing citizens of this country right now on every neighborhood corner in this country."

Derrick: "Mr. Speaker, all of us know what the problem is. There are large parts of our country today that the government can no longer

protect its citizens in. You know, if we want to see the route that we are headed for out in the future, what we need to look at is the places of crisis in the world today, to look at Bosnia, to look at Somalia, to look at Haiti, to look at other places around the world where guns have gotten out of control and government can no longer protect its citizens."

Rep. Carolyn Maloney, D-N.Y.: "Mr. Chairman,

the NRA apparently has never seen a gun it didn't like.

"The 'R' in NRA clearly no longer stands for rifle; I say it stands for reprehensible ... It's suggesting that it would be a blow to democracy for Congress to regulate guns whose sole purpose is to kill as many people as possible as quickly as possible."

Rep. Maxine Waters, D-Calif.: "I rise not to engage in a dispassionate intellectual debate about weapons of death but rather to unashamedly make an emotional appeal ... to vote to save human lives."

Derrick: "If this bill fails today, we are no longer a democracy."

Rep. Cardiss Collins, D-Ill.: "The NRA should realize that they are doomed to failure. Nobody really agrees with their views because Americans know that the NRA stands

for Not Really Aware, or in-Need-of-a-Reality-Adjustment. They must be stopped before these John-Wayne wannabes misuse the Second Amendment to turn America into a shooting gallery."

We also found many comments shockingly revealing:

Rep. Jerrold Nadler, D-N.Y.: "Mr. Speaker, this bill is a good first step toward what I hope will one day be a more comprehensive federal system of gun control legislation — a system that does not prohibit sportsmen from hunting but does protect our citizens from mayhem in the streets. This bill prohibits military style assault weapons that spray a large number of rounds in a relatively short period of time. These large-capacity clips have no legitimate civilian use, period. They are useless to hunters — five rounds into a duck will only make duck soup. They are military weapons designed for use against people — they are perfect for wiping out an opposing gang, arming a paramilitary organization, or shooting students on a bridge."

Rep. Sindy Yates, D-Ill.: "I have read and heard the NRA's arguments and I find them very difficult to take seriously. Nowhere in the basic document of the United States is there a constitutional right, written or implied, giving an individual a separate right to bear arms."

Rep. Nancy Pelosi, D-Calif.: "We are faced by an urgent need to find a balance between the right of someone ... to bear a weapon ... and the right of someone ... to life, liberty, and the pursuit of happiness."

The two always went hand in glove to us.

Rep. Christopher Shays, R-Conn.: "Americans have the constitutional right and protection to bear arms. Their government has the constitutional responsibility to regulate that right."

You can see by these words that the future holds a long, hard fight against some of the mental midgets running the country who would abrogate our rights in the name of safety or the worn out "crime control" cliché. If there was a glimmer of hope among this group it was stumbled upon quite by accident by representative Derrick: "The average citizen out there has a lot more sense than this body [Congress] has." ❧



"... the Constitution does not permit Americans to own bazookas. It does not permit Americans to own antitank weapons. And it does not permit Americans to own assault weapons." Rep. Edward Markey's constitutional acumen was representative of 216 members who sold out the Constitution on 5 May 1994.



# WACO: Justice Takes A Holiday

End of Ranch Apocalypse marked beginning of Stalinist judicial process where government desires overrode findings of a jury of Davidians' peers. Photo: FBI



## **Acquitted By 12, Condemned By One: Davidian Judge Hands Down Maximum Sentences**

**by Dick J. Reavis**

Shortly after the jury delivered its verdicts in the Branch Davidian trial on 26 February 1994, defense lawyers congregated in the bar of San Antonio's Fairmount Hotel to celebrate their victory. Bottles of champagne circulated among the lawyers and their well-wishers who were clustered around a television set to watch as the nation was told the news.

These defense lawyers gathered at the Fairmount again on 17 June, just shortly after sentencing in the Davidian case. A bottle of champagne again stood on the bar — but it may as well have been warm beer. Nobody was celebrating. The lawyers were dazed and downcast, like men who'd been beaten in a playoff game.

The difference in the mood at the Fairmount was the difference between verdicts wrought by a jury of one's peers, and a verdict issued by a vindictive and presump-

tuous judge. It was a difference that — for ordinary Americans — means, that at worst, citizens' liberties have already withered under the heat of government wars against drugs and an armed citizenry. At best it means sleazy judges can now run roughshod over constitutional rights. If there was any consolation for Davidian forces that day it was only that, before going off to prison for the rest of their



Jury forewoman Sara Bain, "The Judge just kind of overlooked the jury's verdict," she said after sentencing. Photo: Dick Reavis

lives, the defendants got a chance to speak their minds.

On 17 June, U.S. District Judge Walter S. Smith Jr., nullified the jury verdicts. He rewrote their findings, putting his own prejudices in their place. He reinstated charges he'd vowed to dismiss; he imposed guilt where a jury had found only innocence. As a result of Judge Smith's handling of the sentences, the Davidians, mostly men in their early 30s, will be in their early 70s before they see the streets again. Five of them are now serving sentences four times as long as they — or anyone — expected.

### About-Face

When their trial opened on 10 January 1994, 11 Davidians were charged with conspiracy to murder federal agents, the murder of federal agents, and various firearms violations. The government, via the conspiracy charge, sought to win life sentences against all 11, even against three who had not been at Mount

Carmel on the day of the shoot-out between ATF agents and the religious community's residents. Four ATFers had died in that gun battle, and the government was out to avenge their blood.

But during the seven weeks of trial that followed, prosecuting attorneys failed to prove their case despite the assistance of 130 witnesses. The jurors took three days to decide that none of the accused were guilty of the principal charges: conspiracy and murder. Instead, the jury found four of them innocent of all charges, and the other seven guilty only of lesser offenses: aiding and abetting voluntary manslaughter and several weapons possessions counts. Or — it had almost done that.

The jurors' verdicts had not been entirely in line with the instructions Judge Smith had given them, nor entirely consistent. In Smith's instructions to the jury, the conspiracy charge was referred to as "Count One," the murder charge as "Count Two." A charge defined as "using and carrying a firearm during and in relation to the commission of an offense," was termed "Count Three." Smith's instructions to the jurors regarding Count Three were:

"For you to find the defendants guilty of this crime, you must be convinced that the government has proved each of the following beyond a reasonable doubt:

"First: That the defendant under consideration committed the crime alleged in Count One of this indictment. I instruct you that 'Conspiracy to Murder Officers and Employees of the United States' is a crime of violence.

"Second: That the defendant under consideration knowingly used or carried a firearm during and in relation to the defendant's commission of the crime alleged in Count One of the indictment."

Defendants could not be found guilty of Count Three without first being found guilty of Count One.



Circus, complete with tent, outside courthouse. Davidians received little sympathy in the mainstream press and few newspapers responded with outrage at the travesty of justice acted out in San Antonio. Photo: Dick Reavis

Smith told the jurors, in effect, that Count One, or conspiracy, was a left shoe, and Count Three was the matching right shoe. The jurors were to pair the two shoes — or issue a bare-foot verdict of not guilty.

The jury goofed. It found all 11 of the Davidians innocent of Count One — but found six of them guilty of Count Three!

Smith noticed the inconsistency as soon as he eyed the jury's report sheet. He gave out a long and audible sigh, then called both defense and prosecution attorneys to the bench, asking them what they thought he should do. The prosecution urged him to send Count Three back to the jurors for rectification. Defense attorneys urged him to throw out the finding, to dismiss it. It was a Saturday afternoon, and Judge Smith was only two hours away from his home in Waco. "...The court will set that finding aside," the Judge ruled, explaining that the only rectification he expected the jury to make, if he sent the question back to them, would be to find the defendants not guilty of Count Three.

Smith immediately ordered the release of two of the 11, Clive Doyle and Woodrow Kendrick, who had been exonerated of all charges. The following Monday morning, Smith also ordered two others, British citizen Norman Allison and Canadian Ruth Riddle, released to the custody of the U.S. Immigration Service, for deportation home. Riddle had been convicted of Count Three. The judge's decision was clear. He had thrown out the charge.

But within three hours, on prompting from the prosecution, Judge Smith changed his mind. He had Riddle ar-

rested again. Yet he denied he'd done an about-face. "... The court always spoke prospectively, noting that it 'will' set the verdict aside," he explained. Yet the transcript of the trial shows that he had thrown out the count, period: "... that portion of the verdict simply cannot stand," were among the words Judge Smith had spoken to the attorneys and court stenographer, who recorded every syllable that came from his mouth.

When they found out, among those horrified by the judge's flip-flop was 69-year-old juror Jeanette Felger. "I would never have voted that way if I had known it was connected to Count One ... I don't want to see Ruth Riddle in jail. I thought she had already been sent back to Canada," she told *The Dallas Morning News*.

### It Was Live Or Die

After the trial, as their date for sentencing drew near, the jailed Davidians huddled with each other to decide what they should do. During any federal sentencing procedure, in an event called "allocution," defendants are given an opportunity to point out anything the judicial process has overlooked, so long as it might have a bearing on their punishment. The Davidians, who had not taken the stand during

the trial, decided to speak out.

On 16 June, when allocution opened, 34-year-old Livingston Fagan, a British citizen and theology graduate, rose first to speak, "The actions that we were forced to take were justified by the actions of the government."

"You made a statement that the government is not on trial here," said defendant Jaime Castillo, a 25-year-

and how they'd actually reacted, on the day of the fateful assault. Anyone who has ever faced a gun knows the feeling.

"I thought that day I was going to die ... I was scared. When you're put in that situation where you've got women and children screaming at us, 'Oh, my God! They're shooting at us! Do something to save us!' you grab something, you do anything you can to live another day, another hour, another minute. It was live or die."

This was clearly the picture the jury had in mind when it found the Davidians guilty of voluntary manslaughter, instead of murder. The judge's instructions to the jury had been very clear, and on this count, the jurors had made no mistake. "Voluntary manslaughter," the instructions said, "is committed when a human being is killed unlawfully in the sudden heat of passion caused by adequate provocation."

"When we heard all that testimony, there was no way we could find them guilty of murder," one of the jurors told the *San Antonio Express-News*. "We felt provocation was pretty evident. When the fire storm started, everybody was trying to cover their behinds."

Renos Avraam, a 29-year-old Englishman of Greek Cypriot descent, reported that jury forewoman Sara Bain, a schoolteacher in a San Antonio suburb, had written

a letter to the judge, saying that the jurors would have voted not guilty on Count Three had the issue been returned to them. The judge told Avraam that Bain's letter carried no weight. "Jurors are not allowed to impeach their verdicts," he said.

On the morning after allocution, the lawyers for both the prosecution and defense made their sentencing

*Continued on page 75*

### THE SENTENCES

<b>Renos Avraam</b>	40 years, with 5 years supervised release, \$10,000 fine, \$1,200,000 restitution
<b>Brad Branch</b>	40 years, with 5 years supervised release, \$2,000 fine, \$1,200,000 restitution
<b>Jaime Castillo</b>	40 years, with 5 years supervised release, \$2,000 fine, \$1,200,000 restitution
<b>Livingston Fagan</b>	40 years, with 5 years supervised release, \$5,000 fine, \$1,200,000 restitution
<b>Kevin Whitecliff</b>	40 years, with 5 years supervised release, \$2,000 fine, \$1,200,000 restitution
<b>Graeme Craddock</b>	20 years, with 5 years supervised release, \$2,000 fine, \$1,200,000 restitution
<b>Paul Fatta</b>	15 years, with 3 years supervised release, \$50,000 fine, \$1,200,000 restitution
<b>Ruth Riddle</b>	5 years, with 5 years supervised release, \$2,500 fine, \$1,200,000 restitution

old California musician. "There's no doubt in my mind that the government should be on trial for its actions."

The strongest testimony came perhaps from Kevin Whitecliff, 32, the hulking giant of the Davidian crowd. Though he is not an articulate man, and though his notes were not extensive, Whitecliff gave a testimony that came closer than any to describing what the Davidians actually faced,



U.S. District Judge Walter Smith Jr., left, and U.S. Attorney Bill Johnston. Acting as judge and jury, Smith sentenced defendants on charges of which they were acquitted. Photo: James L. Pate



# "They Can Shoot You, B

## *Wildcat A-Team Lights Up Charlie's Tree On Christmas Eve*

**Before the Vietnam** war got really serious, some strategic thinker in Washington or Saigon decided maybe the whole thing could be ended by simply declaring a Christmas truce — that if both sides ceased hostilities for two weeks, maybe no one would feel like starting it up again. Nice thought. The first big truce was for Christmas of 1965, and was subsequently enacted every year for Christmas and the Tet holiday.

Other than getting shot in the head and having my camp in constant danger of being overrun, 1965 was a good year. I was initiated in the gentle art of war, and introduced to the world of treachery and intrigue where I lived for the next 20 years.

In '65 I was the sometime commander, sometime executive officer of Special Forces Team A-224, located in the Central Highlands of South Vietnam on what had been *Route Coloniale 7*, at a place called

Phu Tuc, midway between Cheo Reo and the coastal town of Tuy Hoa.

Initially, hunting in our AO was good, but the arrival of large, serious units from North Vietnam made any combat operation far from camp an exciting proposition. We had been mauled fairly severely during the summer and were always leery of bumping into a large unit of NVA regulars, but by December we had recruited and trained a respectable indigenous force, and were feeling cocky and invincible again.

We figured the Viet Cong would take advantage of Christmas and New Year's to create mischief, since most Americans tended to get stupidly sentimental then. The SF soldier of that era was a different breed of cat, however, and most were fairly hard around the edges. We did not take HQ's Christmas-truce directive seriously, and planned to simply ignore it, since we considered the idea at best naive,

and at worst downright *dumb*. But staff weenies in Saigon were absolutely serious, and we were obliged to suspend combat operations and even send a large number of troops home on Christmas leave.

### **Truce Ruse**

Amusing myself at the berm with a sniper-scoped Garand (I didn't think the Saigon staff weenies would miss a VC or two), I heard a commotion outside camp. It was our interpreter Nay Tay, waving his arms excitedly: While the good guys played truce, the bad guys had moved a main force battalion, reinforced with a mortar section, to his home village of Ban Ai Nu, just north of Le Bac bridge where Route 7 crossed the Song Be River. While sneaking and peeking, he talked to some friends who had been sent to collect reeds along the river for making rock baskets and as-

**"After 20 minutes or so it became apparent that what we were witnessing was a meeting of the battalion command group and staff, finalizing plans for the attack on our base. Incredible. It was like my worst nightmare, only for real."**



# ut They Can't Eat You"

by Col. Mike Peck

Illustrations by Dick Kramer

sault mats. (The VC, prior to attacking fixed installations, would force villagers to make large, cylindrical wicker baskets and heavy 3-by-10-foot woven mats. The baskets were filled with rocks and rolled toward the installation by forward assault forces — the VC version of light armor, with the stones affording protection from small arms. The mats were thrown over the barbed wire so assault parties could cross. Both were primitive, but effective.)

His acquaintances informed Nay Tay that the VC planned to take out our camp once and for all during the truce, since their agents informed them that we had sent many troops home. As far as I was concerned, the

baskets and mats cinched his story.

I took this to Captain "Linc" German, our team commander. Linc was smart and tough, and immediately began planning a preemptive strike, after duly reporting the information to the B-Team in An Khe. But they called back and told us to ignore the report, since "there was no way to confirm enemy hostile intentions." *Oh, great!*

German could not simply thumb his nose at the hierarchy, so obviously a large-scale spoiling attack on the enemy's bivouac was out — and we were in deep shit. Attempting to figure the next move, I visited Capt. Le Van Khue, a Montagnard who had begun his military career as an assistant machine gunner with the Japanese in Indochina in World War II, and was later recruited by the Viet Minh — but ended up fighting for the French, then Saigon: Now he regarded himself as fighting for the Americans. He had been wounded a dozen times and was covered with scars; he could speak every language and dialect in Southeast Asia — and I was supposed to be "advising" *him*.

Khue wanted to wade in that night and kick the ever-lovin' shit out of the Cong before they got organized, since their usual MO was to plan things to death. Told this was out of the question, his reaction was the same as ours. So taking turns on his bottle of Johnnie Walker, we developed a plan for a "tiger hunt," simply for fun, up in the area around Le Bac.

The "hunting party" was originally to consist of only Khue and myself, accompanied by a couple of Strike Force squads, reinforced with four M1919A6 light machine guns and four M79 grenade launchers, plus

all the linked ammo and 40mm HE we could carry (the tigers in that area are big and mean). As the plan formed we added specialized personnel, including Staff Sergeant Tommy Toon, team medic. Toon was a pro who meticulously executed whatever was planned and never lost his cool. And it was always nice to have a medic around.

Via Route 7, it was about 25 kilometers from our base at Phu Tuc to the bridge at Le Bac, but to conceal movement and intent, we planned to travel east of the road through relatively difficult jungle. Captain German would stay in camp to "hold down the fort" while the hunting party went about its business.

## Hunting Two-Legged Tigers

Although I had carried every weapon in the World War II inventory during my tour, and had separate rucks packed with an eclectic mix of U.S., French and World War II German gear for specific missions, I normally went out with an M1A1 Thompson. As much as I loved that Thompson, though, it was really too heavy for mobile warfare: For moving far or fast, I usually packed an M2 .30 Carbine with a modified M1A1 paratrooper stock. The carbine was lighter than the Thompson and the ammunition was half the weight.

For backup I carried a Chinese Type 51 Tokarev pistol taken from a VC lieutenant I killed in September, and a Fairbairn-Sykes Commando knife and LBE loaded with gear of choice for the particular mission. I had worn my green beret on operations, but after I got shot in the head and discovered it was not really bulletproof, I was cured of that habit. Of course, no one wore socks or underwear.

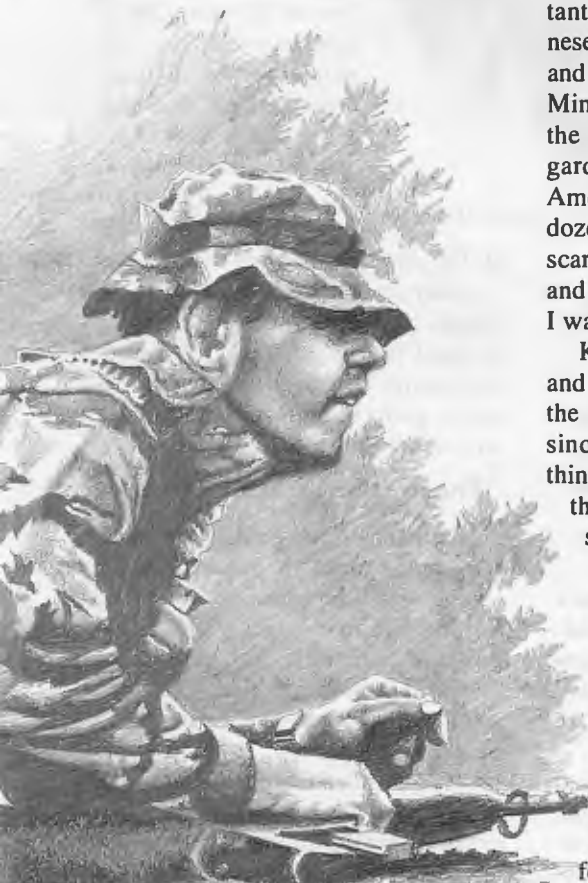

DICK KRAMER © 1994

Early the morning of Christmas Eve we all had a couple cups of the cook's high-octane French coffee and left as planned, making as little noise and commotion as possible while crossing through our own barbed wire, over the airstrip and past our OPs in the darkness. We often did send hunting parties to bag fresh game for the camp, so it would not appear unusual in case we had rats in the camp. Once in deep jungle, we guided on the road, staying well back in the protective screen of vegetation. We would not only be able to remain oriented, but could observe the road, in case the communists had the temerity to move down it in broad daylight.

In December the Highlands can get chilly at night, but dawn still comes with that incredible majesty of color and cacophony of sound unique to the South Vietnamese jungle. No matter how tired, scared, or down you might be on a night operation, at first light you are inevitably imbued with renewed hope and enthusiasm, brought by the infectious energy of the sun and the shrilling of thousands of disparate life forms who, with the arrival of daylight, are lustily rejoicing that they, too, survived to play the game of life for yet another day.

We moved out with a small element from Recon Platoon as point, a flank element on the left to orient on Route 7, and a larger group screening the higher ground to the right. The command group consisted of myself, Toon, Nay Tay, Khue, and his radio operator/batman known as "Dootenhaf" by the interpreters, because he was usually loaded like a 2-1/2 ton truck. We had a PRC-25 for comms, and for internal comms used CIA-issue HT-1s. The point and flanks were armed with M3A1 "Grease Guns" or M2 Carbines, and did not carry rucksacks, their supplemental gear being divided among the party. They normally roamed ahead and back and forth, covering more than three times the distance the rest of us did. They did not rotate, since they were all from that area and had hunted it since childhood.

The main body comprised two reinforced squads with machine guns, grenade launchers, and ammo. Notwithstanding their size, those guys

never complained and never fell out of formation, even though a 1919A6 Browning weighed about 35 pounds with a 100-round belt wrapped around the gun. Some old-fashioned guys, who liked to hit what they shot at, had M1 rifles, but most not carrying special weapons were armed with carbines, and the grenadiers had .45s.

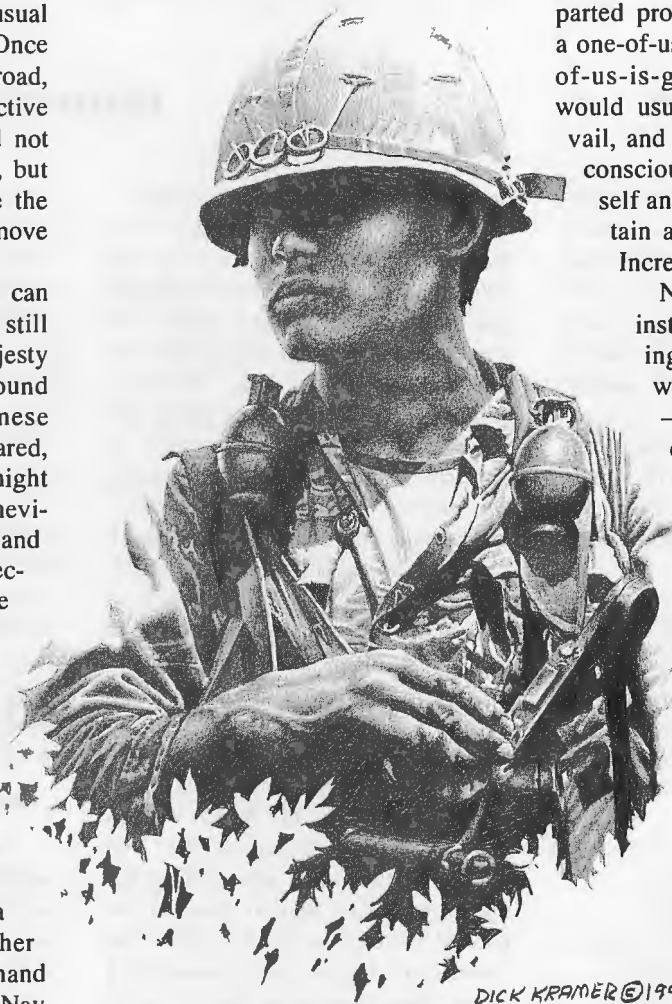

**"...The command group consisted of myself, Toon, Nay Tay, Khue, and his radio operator/batman known as "Dootenhaf" by the interpreters, because he was usually loaded like a 2-1/2 ton truck ..."**

We also had a rear guard ranging back and forth to ensure we were not followed. Other than the modern weapons and uniforms, it was an ancient scenario, dating from the dawn of time — hunters on the prowl.

In the jungle, I could allow myself to sink to a primeval psychic level, tuning out conscious awareness to allow my body to function on a sort of

automatic pilot — an atavistic mechanism inherited from vague and shadowy ancestral warriors whose highly honed survival skills flitted like tiny memory bats in the innermost labyrinths of my subconscious mind, where they had been implanted as a part of my genetic heritage. The instincts these ancient predators imparted proved unerringly correct. In a one-of-us-is-going-to-live-and-one-of-us-is-going-to-die situation, I would usually let my instincts prevail, and sometimes it felt as if my conscious mind had detached itself and was watching with a certain amount of studied interest. Incredible experience.

No one in the group needed instructions or orders, all coming from stone-age villages where they lived a harsh life — and where the careless died young. We lapsed into either an introspective or a mindless silence, broken only by the creaking of equipment, an occasional clink from a loose buckle, or the labored breathing of machine gunners as they climbed the banks of intermittent streams. Even for someone in his early 20s in good shape, all that ordnance was a difficult cross to bear. The only piece of equipment I did not mind carrying was my M2 Carbine: 6.1 pounds of sudden death,

at 750 opportunities per minute.

After several hours of humping the jungle, you actually started looking forward to a good fight, just to unload some ammo and toss a 15.88-ounce grenade or two at some Dink who should have stayed in Hanoi.

### **There's Rules Against That**

With locals for guides, we made fairly good time. The move up to the bridge was uneventful, although we *did* stumble on the tiger we were supposed to be hunting. And a big one. I can still remember the drumming sound of his paws, like the pounding of a horse's hooves, as he streaked by. Had he attacked someone it would have blown the operation, since everyone would have instinctively opened up on him. Back in that land

which time almost forgot, people still struggled with the ancient problem of hustling up their dinner — without providing some other life form its dinner instead.

The prospect of being eaten by a predatory carnivore is another of those timeworn fears that harks to our ancestral beginnings and strikes chords of terror in supposedly rational beings. But as modern soldiers, we were much more advanced than the unfortunate, unenlightened tiger: Unlike him, we hunted down and killed members of our own species, then left them to rot in the sun. Nothing uncivilized about us. Staff Sergeant Jimmy Steel, our team demo/logistics expert, was fond of saying, "Vietnam ain't so bad. They can shoot you, but they can't eat you. There's rules against that."

At about noon we stopped for a cold, dry lunch, making a perimeter by simply marching in a circle until we closed on ourselves, with the flanks setting up outer security, while the point and rear elements came into the center to confer. There was no movement on the road or trails, indicating the VC were controlling traffic from the villages.

It was still light when we approached the bridge, so we moved to a hill east of Ban Ai Nu, where we set up an objective rally point. It was a decent place for a final stand, not on an obviously direct line back to Phu Tuc if we were pursued, and a good place to observe the area prior to the operation. The VC were busy tearing up a section of the bridge, the bed of which was made of railroad ties, removing enough planks to preclude a mechanized force from coming to our rescue from Cheo Reo. The Cong were merrily burning the stacked timbers, which was generating a great deal of smoke. Burning the bridge timbers instead of tossing them in the flooded river was probably nothing more than grandstanding to impress the villagers — or themselves.

From what we could observe at

that distance, the VC team was at least battalion strength, and had set up a semicircular perimeter, with the village of Ban Ai Nu in the center and their backs to the river. They were swaggering



DICK KRAMER ©1994

**"...Toon, always the cool hand, damn him, may have opened fire first, since I still remember his loud-mouthed AR-15 going off beside my right ear, but if he beat the rest of us to the draw it was only by a millisecond ..."**

around, with no effort at concealment, apparently enjoying Lyndon Johnson's Christmas present. They had also set up a pyre of planks from the bridge in the south-center of the town. It appeared the villagers had been moved out by the paranoid VC, and were being held in a compound to the northeast. That was good: We could now indiscriminately shoot the shit out of the place.

We were sweaty from the march, and with the advance of darkness I began to shiver, although I never knew at such times whether it was really the cold or whether I was simply nervous. While Khue, Toon, Nay Tay and I studied the scene through binoculars, the troops had another cold meal and rested, as soldiers have done since time immemorial, never knowing when they will have the next chance. It was important to recover from the grueling march before going into action, outnumbered at least 10 to one.

### **Amphibious Assault**

Based on details supplied by Nay Tay and what we could see, we decided to attempt an infiltration of the enemy perimeter under cover of darkness, to take out their communications center and supply dump, while eliminating any leaders we found in our sights. We would then exfil and signal the troops to shoot the place into hamburger with the machine guns and grenade launchers from our side of the river. Clausewitz might not have approved, but all we really wanted to do was disorganize them enough to buy a week until our leaders woke up and called off the ill-conceived truce.

After dark, we deployed most of our fire support force on high ground on our side of the river, leaving a heavy flank to the south to secure our retreat route. The southern flank was also charged with booby-trapping the bridge with grenades while we did our dirty deeds. At the river bank, however, we discovered why the VC had backed up against it — the depth and swiftness of the water there made it unfordable, at least to the average Montagnard/South Vietnamese. So much for the best laid plans of mice and men.

Since the only place to ford was directly under the bridge, which still served as a source of amusement for the VC, I was all for scrapping the infiltration scheme, and backing off to simply blow hell out of the place from across the river. Not Capt. Khue, though: Our Montagnard madman would have none of that. His cunning scheme was to leave the bulk of the infiltration party on our shore to

cover us, while Toon and I, who both stood over 6 feet, carried him and Nay Tay across. The Johnnie Walker must have addled his brain. As I got ready for Khue's insane little adventure, I knew it was not the cold that was making me shake.

I slipped the Tokarev into the right cargo pocket of my trousers, stuffed

perly rocks scattered at random on the bottom.

I was precariously top heavy. On tiptoes, the water lapped at my nose, and at times both Toon and myself would be submerged for short periods when we stepped into holes, which in me at least caused flashes of sheer panic. What a trip. With

excruciating  
slowness we  
worked

goats and chickens, before pausing to assess the situation. I was soaked through and half-drowned, but ready for a little excitement simply to warm up and revive. While huddled trying to decide the next move, a gaggle of Dinks officiously bustled up to the pyre, doused it with gasoline, and lit it. We eased back into the shadows to observe the festivities. After 20 minutes or so it became apparent that what we were witnessing was a meeting of the battalion command group and staff, finalizing plans for the attack on our base. Incredible. It was like my worst nightmare, only for real.

I finally got so cold I poked Khue and whispered, "What now, Cap'n?"

He did not answer immediately, but finally turned and murmured in French, "You know, Peck, I've always wanted to die on Christmas Eve in Ban Ai Nu."

"Me, too, Cap'n; me, too."

### Firelight Firefight

I nudged Toon, who needed no further prodding, and the four of us stepped into the circle of firelight. My heart was racing, and the scene from *Gunfight at the OK Corral* careened crazily through my mind. Toon, always the cool hand, damn him, may have opened fire first, since I still remember his loud-mouthed AR-15 going off beside my right ear, but if he beat the rest of us to the draw it was only by a millisecond.

Dear Sweet Jesus, the whole thing took on a surrealistic aspect, almost in slow motion, with the burning timbers, the dodging and weaving figures in black pajamas, the dancing shadows, the blinding muzzle flashes, the curling smoke, the discordant staccato of automatic weapons, the *crump* of a grenade, the vague mental note that all the gunfire was probably bad for your ears, the screams of the dying, the smell of burning powder, the smell of fear — maybe theirs, maybe yours — the carbine coming up dry, the flash of panic, immediate recognition of the problem, the rote and practiced changing of magazines, watching with interest as the dust flew out the back of a guy's shirt as a trio of bullets smacked into him in the

**"... [Khue] finally turned and murmured in French, 'You know, Peck, I've always wanted to die on Christmas Eve in Ban Ai Nu.' "**

a spare magazine into the one on the left, and wondered how waterproof Chinese cartridges were. I passed my carbine, web gear, and maps to Khue, hoisting him onto my shoulders, while Nay Tay and Toon did the same. Toon and I locked left-on-right/hands-on-wrists for mutual support and ventured out into the river. It was cold, swift, deep and treacherous, with slip-

our way over, made the far bank, did a few laps around our rosaries, readjusted equipment, then crept up the little ravine that led directly into the edge of town.

There were no sentries or OPs, thank Buddha. Nay Tay, the interpreter, and Khue, the lunatic, took the lead as we picked our way gingerly under the longhouses among the

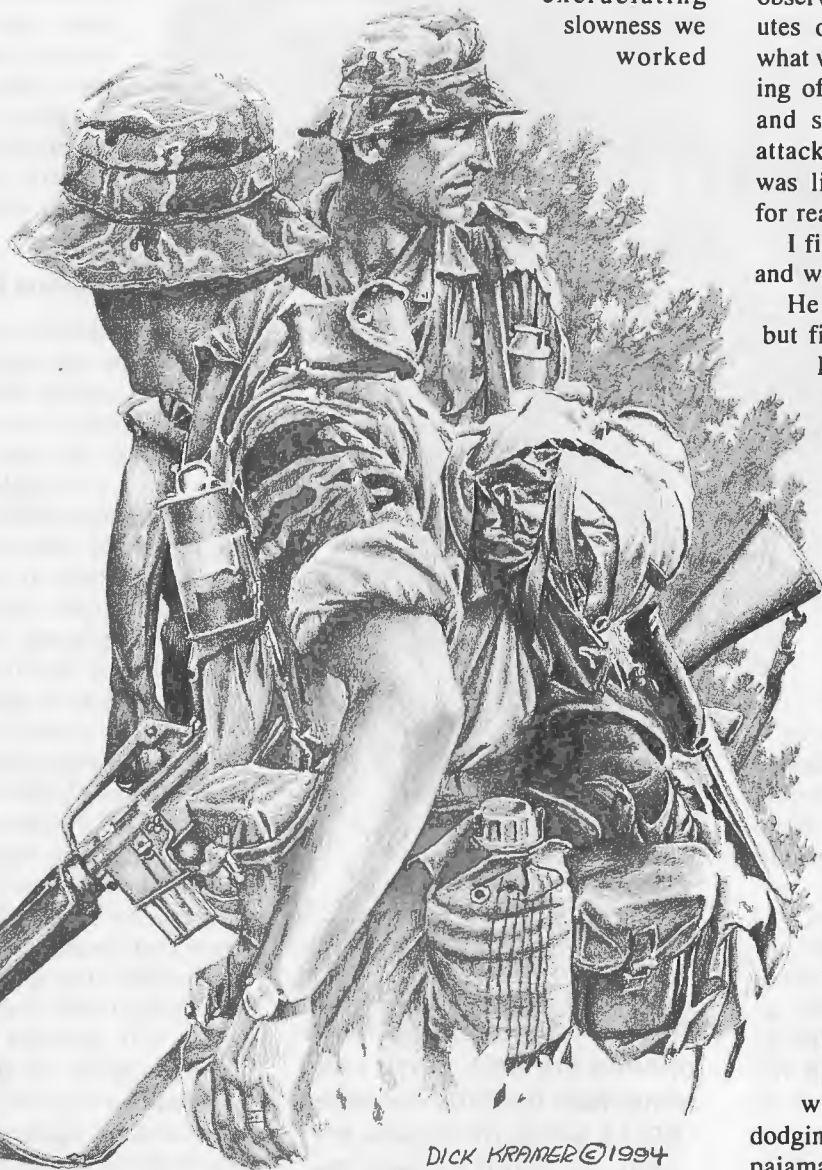

firelight, and all the while the bizarre thought cloying at the edge of the vestigial part of your conscious mind that you probably could have been a lawyer in Cincinnati ...

The carnage and blood lust ended for me when I went through all the magazines in my left-hand pouch, and momentarily forgot I had four more in the right pouch. Completely overlooking the highly sophisticated and murderous Tokarev on half-cock back in its holster at my right side, I instinctively and basically went for the knife on my left when I thought I was out of ammo. Crouching in the midst of that mayhem clutching the reassuring bronze hilt of the Fairbairn-Sykes dagger brought me back to reality. I idly observed that Toon had rushed up close to the bonfire and snatched all the map cases and documents left by VC on the way to meet their maker.

While marveling at Toon's presence of mind, I tripped over a body — which turned out to be alive. I still had my knife in my hand, and was about to sink it into the toad I had stumbled over, but he scrambled to his knees, and was bowing, with his hands clasped together in the Vietnamese sign of surrender, while squealing something which I could not understand. This caused me to hesitate. *Sum 'bitch!* I should have stuck him before he got up, but, instead, thanks to my inhibiting Judeo-Christian upbringing, I rapped him on the top of the head with the butt of the knife, "Merry Christmas," then fumbled around trying to get the damn thing back into its sheath. By the time I succeeded in that, I got smart about my ammunition situation, and stuffed another magazine into the carbine, and Khue was bawling for us to bug out.

No one needed a second invitation. My boy was down, but not completely out, and for want of a better plan, since my superego had decided it would not have been sporting to kill him after he surrendered, I grabbed Mr. VC by the hair and scuttled for the ravine dragging him behind me, while subconsciously hoping I would inadvertently break his neck in the process. As we made good our escape, the entire VC battalion opened up on itself, not knowing what was going on, and began to shoot itself to pieces.

Reaching the river bank, Khue fired one of those goddamn hand-held flares, which always scared the bat-shit out of me when they went off with that hair-raising *WHOOOOOSH*. That was the signal for our fire support element to do its magic, and the whole place looked and sounded like Omaha Beach on D-Day. Toon and I skipped the niceties, and hoisted the two Yards on our shoulders and headed for the other bank, with me still towing my VC charge, who was trying, with only a certain degree of success, to keep his head out of the water. The whole place was lit up like a Christmas tree, very

again forgetting what a pain in the ass it was to get back into that floppy little leather scabbard. The blued steel of the blade glinting in the light of the burning village seemed to reanimate my prisoner sufficiently, and we all moved out to link up with the southern security element.

The firing from our side had slacked off except for the continued *bloop* of the slow-loading M79 grenade launchers. The VC still banged away like hell's delight, and, with most of their leaders dead, had abandoned all rules of fire discipline. Khue and I fired simultaneous flares, which again caused the hair on the back of



At left is Montagnard veteran Capt. Khue, Capt. Bill Suhanin, the author as a first lieutenant, and indigenous troops. Photo: courtesy author

appropriately, and I was afraid some bright-boy commie would spot us in the middle of the river, and cook our collective Christmas goose.

### Exfil And Home

With the VC preoccupied with their fratricide, our luck held and the security force formed a human chain on the far bank to help us ashore. Toon still had all his documents, plus a couple of pistols, and I had my VC. My prisoner promptly collapsed on the bank, so Toon and I lifted him by the legs and poured the water out of him; it was really unbelievable how much he had shipped during the crossing.

After draining Charlie's bilges, I told him in Vietnamese to get his ass in gear. Still sputtering and gagging, he laid back down and shook his head. I pulled the Fairbairn-Sykes, once

my neck to rise, to signal the support element to cease fire and save ammo for the trip home. They were deployed in a semicircular, linear formation, in march order, so we spent a minimum amount of time un-assing the area. Our only wounded was a grenadier who had shot himself in the calf with his .45.

Unable to contact anyone by radio, and rather than stumble around in the dark, Khue decided to remain overnight at the next town. We set up an ambush in case we were followed, or in the unlikely event the VC did not abandon their attack plan. I was beyond fatigue after the march, the two river crossings, and the gunfight, so I "did not advise otherwise." After we redistributed ammo, there still appeared to be enough to hold out for

*Continued on page 86*

# Editor's Picks For Righteous Reading

Dozens of books cycle through *SOF's* editorial offices each month and are quickly forgotten. A choice few, however, beg to be recommended to a wider audience.

by *SOF* Staff

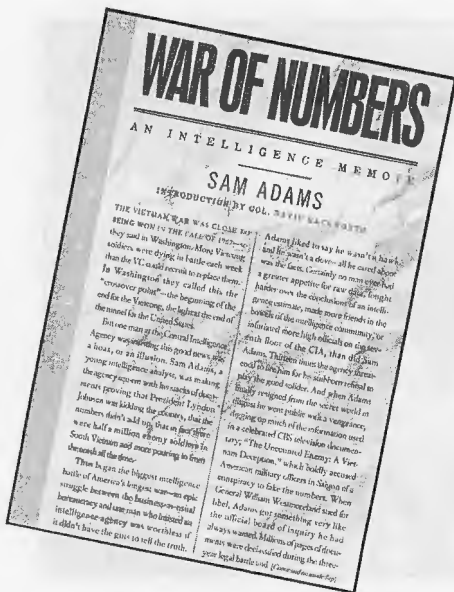

## **WAR OF NUMBERS**, *An Intelligence Memoir*, by Sam Adams.

While hundreds of books have been written about the political and military aspects of the Vietnam War, *War of Numbers* is the first volume to give readers an unabashed look at the botched intelligence picture.

Distorted intel was a crippling factor in our effort in Vietnam and Adams, a CIA analyst in the Southeast Asia Section, shows how and why the numbers were perverted. Basically, duping the American public took precedence over providing our guys on the ground with the truth. Sad, tragic, and more than a little sickening, *War of Numbers* provides insight light years beyond its 230 pages and should be required reading for everyone in the intelligence community.

Hardback. Introduction by Colonel David Hackworth. \$22 from Steerforth Press, P.O. Box 70, South Royalton, VT 05068.

## **ALWAYS A WARRIOR**, *The Memoir of a Six-War Soldier*, by Charles W. Sasser.

One of the very few autobiographical works we found hard to put down. Gritty. Honest. Tough and tender. Erskine Caldwell in tiger stripes.

Sasser uses the vehicle of his own 25-year military career to carry the reader on an insightful journey through the heart and guts of a professional soldier who tries to understand why men enlist, why they fight — and why they put up with a military establishment that doesn't always favor, let alone reward, the warriors. Readable, flavorful: Were it not all true, it would be excellent fiction. His personal odyssey from the hills of Oklahoma to combat in six wars is a good read in itself, and Sasser's pithy observations are worth the consideration of anyone who would lead, or be, a grunt.

Paperback. \$5.50 from Pocket Books, Simon & Schuster Building, 1230 Avenue of the Americas, New York, NY 10020.

## **LEADING THE WAY**, *How Vietnam Veterans Rebuilt the U.S. Military: An Oral History*, by Al Santoli.

The Wilderness Years following the Vietnam War were a time for national reflection on the wisdom of sending men to fight whom you are not prepared to support; of entering a war when you are uncommitted to victory. And it was a time for our dedicated

— and betrayed — military professionals to reflect on the lessons to be learned, lest we slide into another Vietnam, or fight the next war like the last one.

That the lessons were discerned and learned was proven by the striking success of Operation Desert Storm. It was a different war, with a different foe and in a different setting — but the leaders who led the Coalition forces to a stunning victory had distilled their craft in the steamy cauldron of Vietnam.

Through the medium of oral history, Santoli chronicles the story of the small group of courageous and dedicated professionals who rebuilt a

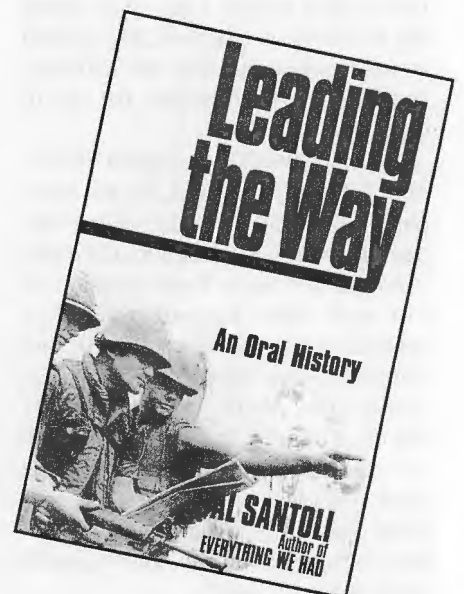

largely demoralized military establishment: These are largely the stories of men who rose to the occasion. Although an easy read, this is an important work — not only because it contributes greatly to the body of historical work on the Vietnam War and the post-Vietnam period, but because it carries with it the explicit warning that in these particularly unpredictable times, the lessons of the last war must be learned and applied to each new scenario.

Hardback. \$23 from Ballantine Books, 201 E. 50th St., New York, NY 10022.

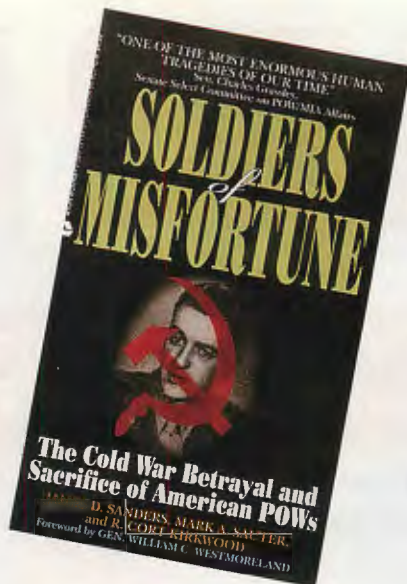

**SOLDIERS OF MISFORTUNE**, *The Cold War Betrayal and Sacrifice of American POWs*, by James D. Sanders, Mark A. Sauter and R. Cort Kirkwood.

An understanding of the American POW/MIA tragedy could well start with this incredible volume. There has been a diverse spectrum of men in the White House since World War II, and this tenaciously researched volume documents betrayal of American POWs under virtually every administration and from every war, and a continual and complete cover-up spanning some 50 years. Starting with more than 20,000 GIs grabbed from Nazi prison camps as bargaining chips by the Soviets after World War II, to documented cases of hundreds of POWs shipped to communist gulags during Korea and Vietnam, this book is a litany of wholesale betrayal and callous Cold-War politics in an arena where our fighting men were as expendable as a wing tank. It's a true story that those in the government with vested interests have tried to silence. Enlightening. Terrifying. Sickening. Enraging. A must read.

Paperback. \$5.50 from Avon Books, 1350 Avenue of the Americas, New York, NY 10019.

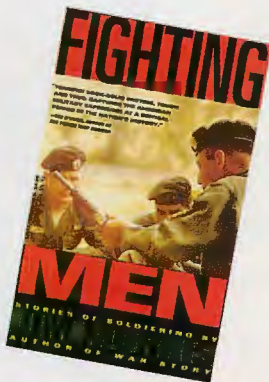

**FIGHTING MEN**, *Stories of Soldiering*, by Jim Morris.

Three-tour Vietnam vet and former SF Major Jim Morris has compiled nearly 30 true war stories in a single volume — and it's one of the best anthologies of SF and behind-the-lines escapades we've yet seen. These stories, of course, are all stories of brave men. That's a given. But *these* are the stories those brave men tell to each other about each other — more often than not because they're *funny*: If you're writing about what you've done and seen, as opposed to a compiled history, you have far greater license for irreverence. If some psycho-wonk or staff-weenie historian wants to understand what makes SF types tick, hand him a copy of Morris' *Fighting Men*. You'll want to read it first yourself, of course, but don't start until you've set aside time to do it all — because this is not a book you can put aside: The stories are short, but there's always one more and you can't read just one...

Paperback. \$4.99 from Dell Books, Box DR, 666 Fifth Ave., New York, NY 10103.

honorably served their country. Here are two of the best volumes available on how to access those benefits:

**COMPLETE GUIDE TO FEDERAL AND STATE BENEFITS FOR VETERANS, THEIR FAMILIES AND SURVIVORS**, 11th Edition, by Robert L. Berko.

With 240 large-format pages, Berko's book is generally considered the classic in its field. Includes sample applications forms. Paperback. \$14.95 from Consumer Center, 350 Scotland Road, Orange, NJ 07050.

**VETERAN'S BENEFITS**, *The Complete Guide*, by Keith D. Snyder and Richard E. O'Dell with Craig Kubey.

A new book and a very good one. If you're contemplating consulting a lawyer about a veteran's benefit or claim — get this book first: It was written by two lawyers and a state director of veteran affairs. More than 400 pages, with excellent directories of DVA offices, vet's advocacy groups, etc. Paperback. \$15 from HarperPerennial, 10 E. 53rd St., New York, NY 10022-5299.

**DICTIONARY OF MILITARY ABBREVIATIONS**, by Norman Polmar, Mark Warren and Eric Wertheim.

If you're like this writer and your dog-eared copy of *JCS Pub. 1* is two decades out of date and has both covers taped on, this new compilation will be of interest. Militarese is not only rife with acronyms and abbreviations — but now we even have *acronyms* that are made up of acronyms. Then there are those Navy "abbreviations" of letters that don't appear in the term being abbreviated — confusing to us ground-pounders. This is a clear, complete and authoritative volume that will help you keep it all straight. Hardcover. \$23.95 from Naval Institute Press, 2062 Generals Highway, Annapolis, MD 21401

### Veteran's Benefits

Although one of the benefits a GI should not expect may be that his government will risk political benefit to bring him back from enemy POW camps, the American *people* care about their troops, and there are many benefits available to GIs who have

**GUIDE TO OVERSEAS CORRESPONDENCE AND INTRODUCTION CLUBS AND SERVICES**, by Richard Rongstad.

Judging from the recurrent advertising, there must be strong interest among *SOF* readers to meet exotic

*Continued on page 70*



# CLEAR AND PR

## SF Advisers Train Clancy's Sniper Team

by Dan Gagliasso  
Photos by Bruce McBroom

**Film director Philip Noyce** studied the young trooper in front of him seriously: "You look a little young for this kind of game."

"Special operations is a young man's game, sir."

Noyce nodded appreciatively, "You think you can put a team together for me?" With a hint of a smile, Jared Chandler snapped, "Yes, Sir!"

Chandler, 26, an SF trooper from Special Operations Command was about to be entrusted with the training and technical advising of the actors who would portray a SpecOps sniper team in Paramount's version of Tom Clancy's *Clear And Present Danger*.

John Milius wrote the screen version of Clancy's story of an Iran/Contra-type operation gone amuck, wherein a covert sniper team is sent to Colombia to avenge a drug cartel's assassination of an FBI director.

Chandler and fellow SpecOps trooper Steve Goyen went to the wall to ensure the Special Operations sections of the film would be portrayed in the most authentic way possible. Chandler was approached for this unique mission in August 1993, just coming off duty at Fort Benning, Georgia.

He had already made a reasonable supplement to his Army pay as a professional actor for the last eight years: *SOF* readers may remember him as the baby-faced pilot "Razor" in *Flight of the Intruder*. Chandler's new assignment was to take actors Willem Dafoe, Ray Cruz, Benjamin Bratt and Jamie Gomez and pound them into credible Green Berets who could terminate the most powerful drug lord in Colombia. They would have only a few weeks to get the four actors

up to speed:

Bratt and Cruz were cast in the roles of Hispanic Special Forces types; Bratt as the seasoned team leader Captain Ramirez, and Cruz as the team's expert sniper, Sergeant Chavez. Dafoe would be called on to pull off the part of



Ben Bratt is the seasoned team leader, Capt. Ramirez, who brings his crack team into the jungles to take down the nefarious drug lord who ordered the assassination of an American FBI director.



From left to right are Ray Cruz as team sniper Sgt. Chavez, an unidentified stunt man and Ben Bratt; their SpecOps mentor Jared Chandler is kneeling in front.

Continued on page 79

# ESSENT DANGER



Hit man from the drug cartel assassinates FBI director in La Paz with an RPG, triggering a war between the narcos and Washington.



Jamie Gomez plays the tough sniper-observer Osso, as the team infils the narco's home turf, tasked with revenge.

The team's vendetta goes high-tech as a smart bomb slams into the drug kingpin's remote South American hacienda.

# Ruger/Leupold

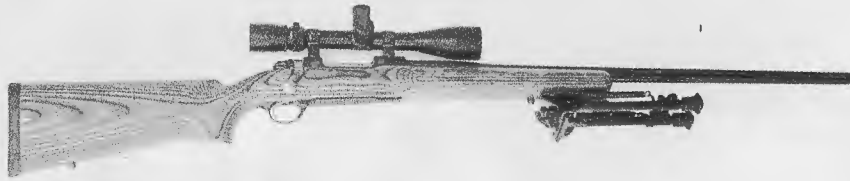

## Accurate System — On Target Price

Text & Photos by Peter G. Kokalis

**Bill Ruger's Model 77 action**, introduced in 1968, has been applied to calibers ranging from the .22 rimfire up to dangerous game rounds such as the .416 Rigby and .458 Winchester Magnum. At one time or another, it has appeared in envelopes ranging from heavy-barrel varmint rifles to African express rifles.

Ruger has recently been focusing on the lucrative, and more politically correct, law enforcement market. Both semiautomatic and selective-fire Mini-14s have filled police rifle racks throughout the country for many years. Their entire centerfire semiautomatic pistol series is directed to this audience, as is, even more obviously, their new MP9 submachine gun. The hiring of Karl Walter, the former head of Glock's U.S. operation, to manage Ruger's law enforcement division is further evidence of Bill Ruger's determination to push for a significant share of police small arms inventories.

One of the latest entries in Ruger's law enforcement catalog is the M-77 Mark II Countersniper Rifle (catalog number M77VTMKII-LE), a variant of the M-77 Mark II Target Rifle. Normally chambered for the .308 Winchester (7.62x51mm NATO) cartridge, it is available in other calibers, such as .223 Remington, .22-250, .220 Swift and .243 Winchester, at the user's request. *Soldier Of Fortune* was sent one of these rifles, chambered for the .308 Winchester round, for test and evaluation.

A highly modified '98 Mauser-type turn-bolt, the M-77 was designed for Ruger's series of so-called *classic* bolt-action sporting rifles built in the style originally popularized by Stewart Edward White and E.C. Crossman in the early days of the Model 1903 Springfield rifle. This concept has been incredibly successful for Sturm Ruger & Co. Inc. (Dept. SOF, 200 Ruger Road, Prescott, AZ 86301-6105; phone: 602-778-6555, fax: 602-778-6633).

Although classic in appearance, in terms of manufacture the M-77 is a thoroughly modern firearm. Ruger is the world's established leader in cost-effective investment casting. Developed at its Pine Tree Castings Division in New Hampshire, Ruger's metallurgical processes are without equal. Strength-wise, modern investment-cast components are every bit as good as, and in many cases better than, *drop* forgings — and far less labor-intensive. In addition, castings do not have the lengthwise grain structure that sometimes induces longitudinal cracking in forged components. Far fewer machining and



gaging operations are required to finish an investment casting. By these methods Ruger has continually placed rugged and dependable firearms into the public's hands at reasonable cost.

The investment-cast receiver, bolt floorplate and trigger guard are all made of heat-treated, chrome-moly steel. The M-77 receiver, unlike most turn-bolt actions, is slab-sided and the effect is quite pleasing. There is a long feed ramp in front of the magazine-well that leads over the bottom locking-lug shoulder to reliably guide rounds into the chamber. There is also an integral, flat-topped scope base on both the receiver ring and bridge. While shaped like that of the '98 Mauser, the M-77 is far simpler and more rugged.

The bolt handle is integral with the one-piece bolt body. There are dual-opposed forward locking lugs on

# Countersniper



**Above: Ruger M-77 Mark II Countersniper Rifle with Leupold Vari-X III 3.5X-10X variable-power Tactical Scope and Harris bipod provides law enforcement agencies with exceptional accuracy at reasonable cost.**

**Upper Left: Ruger M-77 Mark II Countersniper Rifle's hammer-forged, tapered-contour, heavy match-grade barrel has been free-floated in the black, resin-filled, wood-laminate buttstock, which resists warpage and diminishes the possibility of visual detection.**

the bolt body which engage shoulders inside the receiver ring. A long, one-piece Mauser-type extractor is attached to the bolt by a collar and does not rotate with the bolt. The M-77 action cocks on opening and after the introduction a few years ago of the M-77 Mark II action, the bolt face was modified to provide *controlled feed*. This means that each round is caught by the extractor claw

as it leaves the magazine-well and is *controlled* by the extractor throughout its travel into the chamber. Theoretically, this reduces the possibility of a double-feed and eases the extraction and ejection of an unfired round. There is a spring-loaded blade-type ejector at the bottom of the receiver that protrudes through a slot in the breech face.

In order to clear any optical sight mounted on the action, the M-77 bolt handle has a distinctive low profile. Furthermore, the right side of the receiver is notched to accept the base of the bolt handle, and this arrangement provides the safety lug. The bolt throw is 90 degrees.

The bolt body is drilled from the rear to accept the firing mechanism, which consists of the bolt sleeve, one-piece firing pin, cocking piece and coil-type mainspring.

There is a vent hole on the right side of the receiver ring to direct gases in the event of a case-head failure. One large hole and two long slots in the bolt body would direct propellant gases entering the breech face firing-pin hole downward into the four-round magazine box. This is a very safe action.

The M-77's simple two-stage, stainless steel trigger mechanism, first developed for the Ruger M-77 Palma Match Rifle, is fully adjustable for weight-of-pull (down to 2.5 pounds), take-up and over-travel. The unserrated trigger was factory-adjusted to a pull weight of 2.75 pounds on *SOF's* test specimen. While this is ideal for me, it may be a bit too light for some police administrators. Both the magazine floorplate and trigger housing are steel castings. Pivoting on an axis pin in the bottom of the



Firing the Ruger M-77 Mark II Countersniper Rifle with a Leupold Vari-X III 3.5X-10X variable-power Tactical Scope from the bench demonstrated the high accuracy potential of this combination.

receiver, the sear is tensioned by a small coil spring.

The M-77 has a three-position safety on the right side of the receiver. When rotated fully to the rear, both the trigger and bolt are securely locked. Pushing the safety forward to the middle position leaves the trigger blocked, but permits manipulation of the bolt for loading or unloading. Fully forward is the *fire* position.

All Ruger M-77 rifles feature a unique rearward-angled front guard screw, which, if properly tensioned, helps to hold the recoil lug back against the buttstock and supposedly improves accuracy.

Ruger's Countersniper Rifle is provided with an attractive black resin-filled, laminated, American hardwood buttstock with a rubber buttpad and steel QD swivel studs (one at the rear and two at the front for the sling and Harris bipod). There is no checkering or pistol grip cap. The forend is swelled out on each side in a varmint/target rifle manner. Wood laminates resist warpage and diminish the possibility of visual detection. The barrel is free floating in the buttstock. Length of pull is 13.6 inches (346mm). Drop at the heel is 1 inch (25mm), and drop of the comb is 0.69 inch (17.5mm) — both measurements taken from the bore centerline.

The match-grade, *cold* hammer-forged barrel is made from heat-treated 400 series stainless steel with a black matte finish. Featuring a heavy tapered contour with an overall length of 26 inches (660mm), it has a recessed, target-type muzzle

crown. With six lands and grooves, the rifling has a right-hand twist of one turn in 10 inches (254mm).

Overall length of this rifle is 46.6 inches (1,184mm). The total weight, empty, is approximately 9.8 pounds (4.4 kilograms). There are no iron



Leupold Vari-X III 3.5X-10X variable-power Tactical Scope with a duplex reticle pattern offers exceptional optical quality and performance for almost half the price of their top-of-the-line Mark 4 series scopes.

sights. It is supplied with a set of Ruger 1-inch, blued-steel scope rings.

### Top Scope

With these rings we attached a Leupold Vari-X III 3.5X-10X variable power Tactical Scope (Leupold & Stevens Inc., Dept. SOF, P.O. Box 688, Beaverton, OR 97075-0688; phone: 503-646-9171, fax: 503-526-1475).

This superb tactical scope was

originally developed for the FBI's HRT (Hostage Rescue Team) and is the scope of choice for many of the top tactical teams in the United States. Generally available for only \$476, it is an excellent coupling with the Ruger Countersniper Rifle in both price and quality. Overall length is 12.4 inches, with a weight of only 13 ounces.

The unrestricted diameter of the objective lens is 40mm and that of the ocular is 36mm. Between them lies the 1-inch anodized aluminum tube that houses the remainder of the optical system. All internal and external lenses carry Leupold's special lens coating, Multicoat 4, which significantly improves the scope's light transmission efficiency. This, in addition to a computer-designed optical system, results in edge-to-edge sharpness, precise resolution, minimal distortion and optimum low light visibility. All Leupold Vari-X III scopes are tested for water resistance in a reduced-pressure, hot-water immersion tank before leaving the fac-

tory and are completely waterproof.

The total range of both windage and elevation adjustment is 51 minutes with 15 minutes of adjustment per revolution of the adjustment knobs. This is sufficient travel to elevate Ruger, Remington and other rifles commonly used by law enforcement agencies out to 500 yards. Both dials have quarter-minute visual/audible clicks.

The ocular can be focused by back-

## RUGER M-77 MARK II COUNTERSNIPER RIFLE SPECIFICATIONS

**Caliber:** ..... .308 Winchester (7.62x51mm NATO) — optional calibers include .223 Remington, .22-250, .220 Swift and .243.

**Operation:**..... Bolt-action. Dual-opposed front locking lugs; non-rotating Mauser-type extractor; cocks on opening; 90-degree bolt lift; three-position wing safety on right side of receiver.

**Weight, empty:** ..... 9.8 pounds (4.4 kilograms).

**Barrel:** ..... Hammer-forged, heat-treated, stainless steel, match grade with recessed target-type crown and heavy tapered contour. Six-groove with a right-hand twist of one turn in 10 inches (254mm). Free-floated to buttstock.

**Barrel length:** ..... 26 inches (660mm).

**Overall length:** ..... 46.625 inches (1,184mm).

**Feed mechanism:** ... Four-round integral magazine with hinged floorplate.

**Sights:** ..... No iron sights provided; tested with Leupold Vari-X III 3.5X-10X variable-power Tactical Scope.

**Furniture:** ..... Resin-filled, laminated wood stock with black finish.

**Finish:** ..... Barreled action: black oxide.

**Suggested retail price:** ..... \$665.

**Manufacturer:** ..... Sturm, Ruger & Co. Inc., Dept. SOF, 200 Ruger Road, Prescott, AZ 86301-6105; phone: 602-778-6555, fax: 602-778-6633.

**Scope Manufacturer:** Leupold & Stevens Inc., Dept. SOF, P.O. Box 688, Beaverton, OR 97075-0688; phone: 503-646-9171, fax: 503-526-1475.

**T&E summary:** ..... Ruger and Leupold combination provides superb accuracy at reasonable cost and thus an attractive package for budget-conscious law enforcement agencies.

ing the eyepiece away from the locking and then screwing it in or out until the reticle pattern is sharp and crisp.

Parallax occurs when the primary image of an objective lens does not coincide with the reticle. It has been set at the Leupold factory for a target at 150 yards. Parallax is more noticeable at larger magnifications and at distances less than 50 yards. Leupold can set the scope's parallax at any distance specified by the user.

The magnification range of this Leupold variable-power tactical scope is ideal for most urban law-enforcement applications. The majority of shots taken by police selected marksmen are at ranges less than 80 yards. At 100 yards, the scope's field of

view at 3.5X magnification is 29.5 feet. At 10X magnification, the field of view is 10.7 feet. At lesser ranges the field of view will be correspondingly reduced. If the target is bobbing and weaving (it almost always will be), and the range is short, the lowest magnification should be employed.



**Ruger M-77 Mark II bolt handle is integral with the one-piece bolt body that has dual-opposed forward locking lugs and a long one-piece, Mauser-type extractor attached to the bolt body by a collar. The extractor does not rotate with the bolt.**

view at 3.5X magnification is 29.5 feet. At 10X magnification, the field of view is 10.7 feet. At lesser ranges the field of view will be correspondingly reduced. If the target is bobbing and weaving (it almost always will be), and the range is short, the lowest magnification should be employed.

### Power Up & Down

A duplex reticle pattern is standard, but other reticle systems are available. At 200 yards, the space between the tip of the thicker post and center of the reticle covers 16 inches. The duplex reticle can be used for range finding when used in conjunction with the two sets of numbers on the power selector ring in front of the ocular. The numbers facing front

mately 16 inches top to bottom. Power up or down until the target fits between the center of the crosshair and the top of the lower post. Then, read the approximate distance in yards or meters, from a minimum of 200 at 3.5X magnification to a maximum of 600 at 10X magnification. Remember, as you increase or decrease the scope's magnification, only the size of the target changes; the reticle pattern stays the same. (Note: On this scope, the power selector ring does not serve as a bullet drop compensator.)

I personally believe that the

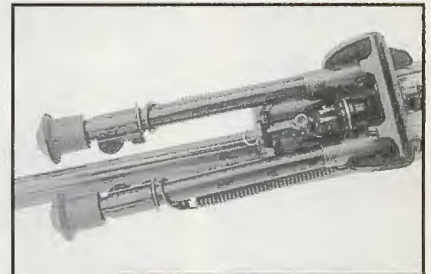

**Harris bipod, while not an object of great beauty, works, is reasonably priced, and provides a firm and adjustable shooting platform.**

Leupold Vari-X III 3.5X-10X Tactical Scope is superior to European scopes selling for two and three times as much. No other law enforcement scope provides this degree of optical quality for such a low price.

I cannot count the number of times I have seen shooters attempt to clean a scope's exterior lens surfaces with a dirty handkerchief, or worse yet, a bore patch. All this does is abrade the lens coating and spread the grit particles and oil more evenly over the lens surfaces. Cleaning a scope lens should be avoided until absolutely necessary and then only with the same care as applied to an expensive camera lens. Leupold's new LensPen is ideal for this purpose. At one end is a lens brush that will suffice for dust and other fine particulate matter. Oily finger smudges can be removed by the LensPen's other end, which contains a special chamois cleaning tip saturated with a non-liquid compound that will neither spill nor dry out.

Whenever possible, a sniper rifle should be fired from a bipod behind cover and concealment. The Ruger

*Continued on page 71*

An aerial photograph of a vast, arid desert landscape. In the upper left, a golden parachute is deployed, with a person or object suspended below it. In the lower right, two soldiers in military gear are visible, one in the foreground and another slightly behind. The terrain is a mix of brown and tan hues, with some faint tracks or paths visible. The sky is a clear, pale blue.

# WHO LASTS WINS

**Few Dare  
Australian  
SAS Selection  
Course —  
Where Only The  
Fittest Survive**

**by Todd Cole  
Photos courtesy author**



SAS performs unique dual role in Australian security: secretive peacetime counterterrorist force, and military surveillance and recon.

**I'd heard that candidates** were indiscriminately beaten, forced to drink blood, starved, dehydrated, shot at and tortured. As ridiculous as the rumors sounded, I'd heard them too many times to reject them outright. So I'd listen with masochistic delight and quiz the narrators for more. Then when an opportunity arose, I volunteered for the Australian army's elite fighting force — the Special Air Service (SAS). All I had to do was pass a two-week selection course.

We arrived at a lonely West Australian army base in three busses. One hundred twenty candidates, known as "rangers," milled around nervously. I expected some immediate inhuman torture, yet supervisors (SAS non-commissioned officers) strolled around chatting with the rangers. The atmosphere was almost friendly.

It wasn't until the third day of grueling physical exercise that the course began to exact its toll. A variety of physical tests and a host of other exercises had to be completed. One of them was a 15-kilometer run, with equipment, in less than 90 minutes. I was running along, encouraging a friend to finish, when he stopped, threw up

After completing the grueling selection course, SAS soldiers undergo airborne training prior to final assignment in one of the regiment's six squadrons.

and refused to budge. I goaded him to get up, using the best motivational trick I knew: I insulted his wife. He came toward me with hatred in his eyes; his mouth was foaming with a mixture of saliva and vomit. He chased me and I ran, continuing my cannonade of insults. Ten minutes later we crossed the finish line. Once he caught up he started punching me. After he calmed down, he said: "It's not worth it, man. This is shit." He walked over to a sergeant and withdrew.

By day five we'd done every kind of exercise imaginable. We exercised from dawn to dusk, then attended lectures on navigation, first aid and weapons until midnight. It would start again at 0500. So far the course had been very hard, but by no means brutal or torturous. I was young and fit, and in a way I was enjoying it.

Apparently 10 soldiers had already withdrawn. Once you invoked a withdrawal, you were transferred out within minutes. Twelve more had been removed because of medical injuries. If your injuries were substantial or you didn't make a sufficient recovery within a specified period, you were withdrawn and allowed to apply the next year. For some soldiers this would become an effective method of saving face.

### Cardinal Sin

I felt I had the right stuff. The first week was nearly up and things were looking good. Then one night, happily devouring my supper, I decided to get a cup of coffee. I walked over to the counter and suddenly felt very naked, very exposed. I looked down. In my right hand was a cup of coffee and in the other was a spoon. *Fuck!* I'd left my rifle on the table out of reach — a cardinal sin. I turned to see a supervisor inspecting my predicament.

The supervisor spoke calmly. "Why do you think we try to instill the idea that you must always carry your rifle with you?"

His calmness unnerved me. I expected some monumental army-style bawling out. I was lost for words, "I ... I ... don't know, sir."

"Let's go for a walk and talk about it."

He talked of discipline and training, espousing the



SAS variant of Hotspur One Fifty carries 7.62x51mm NATO L7A2 GPMG (General Purpose Machine Gun), F89 MiniMI machine gun and a dirt bike. Unique combination of equipment, training and personnel qualify SAS as world-class elite unit.



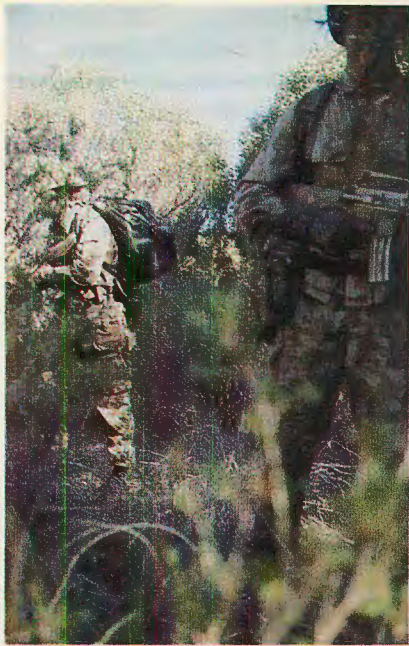

Emphasis on patrolling during selection process reflects importance of SAS wartime missions.

values of reward and punishment. He asked my opinion on the type of punishment I should receive. I thought 100 burpees — a curious combination of a push-up and a jumping-jack — would be fair. He glanced at me with a smile, “Yeah, that’s fair for a normal soldier, but not for a member of the regiment, is it?”

There it was, a loaded question. “One hundred and fifty,” I said. He frowned. “Two hundred and

fifty,” I quickly added.

He nodded, sat down and began to roll a cigarette. At 75 I was exhausted; continuing seemed an impossibility. At 150 I collapsed. I tried to start again, but threw up. I felt sure he would tell me to stop. I stood and reeled to one side, uncontrollably dry-retching in the process. He caught me and smiled, “One hundred and fifty-three — only 97 to go.”

At 220 I was close to passing out. I held my breath and jumped up, hoping to faint — a reprieve. I passed out for a second or two and collapsed. I regained consciousness with my head in my dinner and the supervisor still watching.

“Only 30 to go,” he said encouragingly.

After finishing I collapsed. “I would have been happy with 200,” he said, daintily stepping over me.

At 0300 the following morning, the lights came on and a supervisor in full battle dress stormed into our barracks and told us to ready ourselves for a day-long patrol. We were separated into patrols, given different orders and walked into the night. We marched on through the day and into the night again. Finally we arrived at our destination at about 0300. It was an effort to eat my ration pack and I quickly fell asleep.

What felt like 10 minutes later, we were awakened and driven to another, more desolate area. Following my truck was an ambulance — not a good sign. We were split into different groups and given another destination. At 1500, I ran out of water. At 1800 everyone had run out. With a 10-hour march left and no water, our situation was serious. We had a radio for emergencies, but to use it for water would result in certain failure. We marched on.

We arrived the following afternoon and were promptly returned to our barracks. A lot of rangers had withdrawn during the past 48 hours. We had arrived in three busses and now there were only two. Someone joked that by the end of the course the survivors would be returned to base in a taxi.

An hour later we were back on the busses. As evening fell, I noticed something obscuring the sunset. I strained through the window to see what it could be — the Stirling mountain range. Somehow I knew that was where we were going.

On arrival we were instructed to climb five mountains in three days — alone. However, no one could move at night due to the hazardous terrain. Considering our last exercise had involved considerable sleep deprivation, this one appeared almost enticing.

But on the second day, a minute navigational error resulted in my walking up an extra mountain. Nothing is as deflating as toiling up a 40-degree slope for seven hours and discovering you are on the wrong incline. I completed the mission though, and was driven back to base with the remaining rangers. I knew the course was approaching its 14th day. The end, so I thought, was in sight.

That evening the supervisors, normally aloof, mingled with the 60 remaining rangers. Half a dozen cases of beer appeared and most rangers wasted no time in devouring the lot. Most inferred the ordeal was almost over and we could relax. I noticed the supervisors weren’t drinking much.

### March And Die



SAS looks for “physically and mentally tough men who possess a certain level of maturity ... a soldier ... able to effectively operate in large groups and small patrols, as well as by himself.”

At 0440 I awoke and noticed a supervisor in full battle dress. Something was going on, so I began to get ready for a patrol. Twenty minutes later we were in trucks heading into the bush. I quizzed one of the supervisors. At first he refused to answer, but finally he said: “We’ve got ridda the chaff. Now we gotta get ridda the shit.”

My patrol received our orders. It seemed a simple day’s march when our

supervisor suddenly stopped us.

“One of you is hurt,” was his laconic command. Everybody looked at themselves. “One of you has to be stretchered,” he clarified.

We had a man nicknamed “Tiny” who was, of course, a 220-pound giant. A more lightweight ranger leaped forward and volunteered, but the supervisor pointed to Tiny. We constructed a rudimentary stretcher and carried Tiny off. It was slow going, and a simple one-day march turned into an arduous day-and-a-half slog. Regardless, spirits were still high: When we reached our destination we would be finished.

For 17 hours we carried Tiny over hill and dale, arriving at 0300 the next morning. We set up camp and ate our last rations. As we were preparing for a couple of hours' rest, our supervisor approached us with one of those "I'm about to tell you a whole heap of shit" looks on his face.

"Listen, fellas. We've had a little problem with the trucks that are coming to pick you up," he said, motioning toward the sunrise.

"What is it, sir?" Tiny asked naively.

"Well, it seems the truck has been captured by 'unfriendlies' and you're going to be taken out by chopper." Why didn't I believe him? "The rendezvous is about 18 kilometers from here and the pick-up time is 1400 hours."

I looked at my watch. It would be easy to make it in that time. We could sleep for two, maybe three hours. "There is just one little hitch," he continued. "You have to take this radio to the chopper as well." He pointed at a large, green army foot-locker. Something told me it wouldn't be light. It turned out to be full of rocks and sand.

"What about rations?" I asked.

"They were in the truck," he replied.

We broke camp, figured out a sling for the "radio" and began to haul it toward our destination. As we left the area I saw a totally empty truck pulling out, followed by the ever-present ambulance.

At 1500 we arrived with our consignment. There, seated in this desolate wilderness, was a supervisor. We all at-



**SAS training and mission requirements are similar to U.S. Navy SEALs. SAS soldiers cross-train in a variety of specialties.**

tempted a cordial greeting, but after 36 hours without sleep it was difficult. "You missed the chopper," he said, smiling.

"What about rations, sir?" Tiny asked.

"Well, the chopper couldn't stay too long, so he only dropped off some water. There's supposed to be," he paused and looked around suspiciously, "some unfriendlies in the area. There's a Land-Rover, though, only about a kilometer from here," he added. He gave us directions and we headed off. Three kilometers later we arrived to find a single supervisor sitting next to the Land-Rover — minus a wheel. It was late afternoon, so we decided to rewheel the vehicle and drive to the truck, now supposedly waiting for us at another destination.

## Australian Wings Upon Their Chests

Since its inception in 1957, the Australian Special Air Service (SAS) has performed a vital two-pronged role in Australia's defensive strategy. The clandestine image of the SAS emanates from its highly secretive peacetime counterterrorist role. However, the regiment has an equally important wartime capability based on reconnaissance and surveillance. It has seen military service in Brunei, Borneo and Vietnam.

According to Major Ian Wing, senior officer at SAS headquarters in Western Australia, the selection course differs considerably from year to year, although certain fitness tests are mandatory. "This year approximately 400 military personnel from throughout Australia applied. Of those, 165 enlisted men and 35 officers were chosen to undertake the selection course." At the end of the grueling 19-day course, conducted in Northam, Collie and the Stirling ranges in Western Australia, 42 men were selected.

Major Wing said the SAS looks for "physically and mentally tough men who possess a certain level of maturity. An SAS soldier must also be able to effectively operate in large groups and small patrols, as well as by himself. Most candidates have spent two to three years in the army prior to commencing the course. Consequently, the average age of the enlisted applicants is 23 to 24, and for the officers it is 25 to 26 ... Most applicants train for a year prior to applying for the course."

Candidates who are chosen to enter the SAS undertake parachute training and go on to join one of the regiment's six squadrons. Major Wing revealed the regiment has highly trained water and airborne operations, vehicle reconnaissance and counterterrorist units. He would not comment on internal organization.

At present, the strength of the SAS is believed to be between 500 and 700 personnel. Of course, true strength of the regiment lies not in its size, but in the quality of its hand-picked, highly trained soldiers.

—T.C.

A ranger known as "Donkey Dick" or "Donk" was losing it. The transparent web of lies unfolding before him was disturbing him deeply. He became short-tempered and ultimately aggressive. After the Land-Rover was fixed, he tried to start it. It wouldn't start — no fuel. I should have known. We couldn't leave it for the unfriendlies, so we'd have to push it, the supervisor informed us.

Donk, in a burst of fury, bashed the Land-Rover with his rifle butt and started swearing at it. He took two steps back and began firing his rifle at it. Despite the fact his rifle was loaded with blanks, everyone, except the supervisor, dived to the ground. Donk finished his outburst and asked to be withdrawn. Shortly, a fully serviceable Land-Rover appeared and Donk was gone — leaving only five rangers to push the thing.

We pushed it all night, and at dawn finally made it to a large open field lined with trucks. Maybe this was it? We were given water and set up camp. We had now gone 48 hours without sleep.

"Get the fuck up!" I awoke to gunfire and explosions,

*Continued on page 74*



Armed and dangerous? Well-equipped to fight armed criminals, federal and local police increasingly slay the innocent — often as not due to basic, easily preventable mistakes. Photo: Eric Micheletti

# Law Enforcement Above The Law?

by James L. Pate

More than a year ago, *Soldier Of Fortune* publisher Robert K. Brown solicited readers to forward instances of abusive and unconstitutional policies and practices toward law-abiding citizens. We were most interested in examples concerning federal law enforcement agencies, because anecdotal evidence indicates the feds are guilty of such violations on a more routine basis, and because they are certainly the most immune to proper discipline afterward.

But documented in this article are also examples of abusive behavior by local law enforcement. Local stories are included not just because of their outrageous aspects, but because it is this magazine's belief that they are a natural outgrowth of the arrogant and high-handed attitude of federal law enforcement agencies, from which local police agencies often take their policy lead.

The law-enforcement community's problems include an apparent preference for confrontation over common sense and repeated serious lapses in investigative competence — a routine failure to check out the most basic information before taking armed action. Unfortunately, an institutionalized arrogance has taken hold, an attitude that if one wears a federal badge and carries a gun, he or she can do no wrong, is above the law and, as we saw in Waco and Idaho, can literally get away with murder.

*SOF* has a longtime and well-documented record of

unstinting support for law enforcement officers: federal, state and local. And it is because of that support that the editors feel *SOF* is uniquely qualified to criticize when necessary. And it is necessary, given the disturbing and still-growing trends we have seen in the last three years.

There seems to be an institutional willingness to endanger the safety and even the lives of many, many innocents in order to pursue carefully

staged publicity events such as the Waco raid. In every high-profile case where the feds have expressed concern for the safety of women and children — women and children have died horrible deaths, either directly or indirectly, because of reckless — and illegal — action by the over-amped and poorly trained agents of federal police power.

This must change, or we in America will wake up in a totalitarian police state where no one is safe from such abuse. So herewith, a rogue's gallery of raffish G-men.

## A Rude Awakening

When Bill and Carolyn Blake woke up at 0615 on 13 May 1994, "We thought our house had been invaded by gangsters and we were going to die," Carolyn said. FBI agents were crouched on both sides of the bed. When the retired couple opened their eyes, they were looking down the barrels of guns pointed at their heads.

"Both of them had the hammers pulled back," said Bill. "They're hollering at us in Spanish. But we don't speak Spanish."

The Blakes bought their home in Logan Square, a northwest Chicago neighborhood, 21 years ago. It is a neat, tile-covered two-story frame home with aluminum window awnings and a wooden porch. Unfortunately, a federal drug suspect used their street address on his driver's license. Even more unfortunate, the FBI never bothered to verify who actually lived there before they pried the locks on the front door and terrorized the Blakes.

The elderly couple was forced downstairs at gunpoint, and it was another 15 minutes before the FBI agents found the courtesy to explain just what in the hell was going on. The agents would not display their badges or official identification when asked to do so, Bill Blake said, although one did produce a business card identifying the G-man as Steve Peterson.

The agents claimed they had a search warrant for the

Blake's home, but refused to show it. They then proceeded to ransack cabinets, closets and drawers in the house, pawing through the Blakes most personal belongings, probably hoping to find *any* contraband that might vaguely justify their blunder. Then, Bill Blake said, the agents left without so much as an apology.

### Scared To Death

The Blakes were lucky they weren't scared to death. Because that's just what happened to the Rev. Accelynne Williams when a 13-man SWAT team burst into the wrong apartment at 118 Whitfield St. in Boston's drug-ridden Dorchester neighborhood.

The Rev. Williams, a native of Antigua, spent 40 years ministering to the physical as well as spiritual needs of the poor and dispossessed throughout the Caribbean. Known for his quiet demeanor and hearty belly laugh, the Methodist clergyman retired a decade ago and moved with his wife to Boston, to be closer to their only offspring, a college student. Growing frail, the reverend passed his days in quiet contemplation, reading his Bible and volunteering his time to help the needy in the hardscrabble, crime-infested neighborhood.

On the afternoon of 25 March 1994, clad in black combat gear and heavily armed with submachine guns and other weapons, 13 Boston cops smashed down the door of Williams' second-floor apartment without warning, acting on an informant's tip that guns and drugs were stashed inside. There was one little problem; the apartment targeted by the street snitch was on the *third* floor.

Terrified that he was being attacked by street thugs intent on robbery, the 75-year-old preacher jumped up from his easy chair and ran to his bedroom. He was tackled, thrown face-down on the floor and handcuffed. Williams vomited once, then had a heart attack and died. He was literally scared to death, doctors said.

The neighborhood reacted with shock and anger. To their credit — and unlike their federal law enforcement counterparts — Boston Mayor Thomas Menino and Police Commissioner Paul Evans owned up to the blunder and even visited Dorchester to take the heat personally. Speaking to about 300 mourners at the Parkway United Methodist Church, Evans acknowledged that "I know there is nothing I can say which will fill the void."

Unimpressed, the Rev. Albert J.D. Aymer stood to strongly rebuke city officials, his remarks eliciting "amens" and other shouts of approval from the otherwise somber congregation.

The police "should ... know the difference between decent, God-fearing people and the criminals," Aymer shouted. "Reverend Williams is dead today because of a society that has gone stark mad."

### Fatal Arrest

When ATF agents kicked down the door of a modest home in East Chicago, Illinois, in February 1992, they

weren't satisfied when the suspect, 17-year-old Jesus Maravilla, made an immediate and peaceable surrender. The agents stormed upstairs and crashed into his father's bedroom.

Melecio Maravilla, 48, who had grabbed a gun to defend himself when he heard the violent entry, was shot in the head, chest and back. The laid-off steel worker died within minutes. His pregnant wife, Evangelina, was overcome with grief and fear. She delivered prematurely and the infant died a few days later.

The ATF tried to justify the elder Maravilla's death by saying he had several weapons in his bedroom. But none were illegal. The agents also claimed that they identified themselves and that Maravilla fired first. "Our position is that it was a justifiable shooting ... an appropriate response for that threat," said ATF spokesman Jerry Singer.

Family members tell a different story. The ATF agents, accompanied by members of the East Chicago police department, did not identify themselves, and did not produce a search warrant until after Maravilla was shot, his survivors said.

Ivan Bodensteiner, the family's attorney, acknowledges that the victim had a gun, but said he was looking out a window when the agents burst into the bedroom. Maravilla, he said, was shot from behind. A wrongful death suit accuses the ATF agents of conducting an unreasonable search, particularly because their suspect surrendered immediately and without resistance. It also alleges the use of excessive force. ATF agents John Malone, Kevin Cronin, Tim Wilson and two unnamed feds are listed as defendants.

### DEA: Drunks Extremely Asinine

On 13 May 1994, five Drug Enforcement Administration agents took a lunch break from a training session at a local law enforcement facility in Highlands Ranch, Colorado, a suburb south of Denver. Their bill at the Sedalia Grill was \$138; \$24 for food and \$114 for beer and shots of liquor. The tab — and the agents — would have been higher, but owner Jody Johnson said a waitress refused to serve the feds more booze after one became belligerent and abusive. That's when the trouble started.

Their rowdy behavior was tolerated at first, Johnson told the *Rocky Mountain News*, because he figured they were "letting off steam." But they became increasingly obnoxious and began flashing their DEA badges, demanding more liquor.

One agent "pulled out his badge and said he was going to shove it into my forehead so hard, I would never forget who he was," said Johnson. "They basically said they could drink anytime, anywhere and if not, they would shut me down."

Johnson quoted one agent as warning him that "I'm a

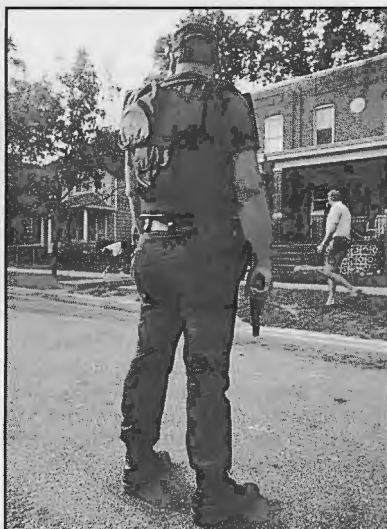

**Washington, D.C. Emergency Response Team takes down an alleged crack house: What if the allegation is falsified by a hungry paid snitch, or an angry former spouse? Or if they simply got the address wrong? If you reflexively resist at 0300, you could be dead meat. Photo: Eric Micheletti**

cop and I could kill you right now and there is nothing you can do about it.”

The agents then began trashing the bar and playing catch with several rounds of 9mm ammunition. Several bullets were left scattered where they were spilled by one drunken agent while another vomited on the floor in view of other disgusted lunchtime patrons.

When Johnson dialed the Douglas County Sheriff's Department, which dispatched two deputies, the feds hastily paid their bill and departed. The DEA agents, riding in two vehicles, were stopped on Colorado Highway 85. Although one driver's eyes were bloodshot and another smelled of alcohol, the deputies did not administer a roadside sobriety test or otherwise delay the DEA agents. Jay Erickson, a DEA supervisor who was with the agents at lunch, reportedly told the deputies that only one agent was intoxicated and was having “some recent family problems.”

Acknowledging his deputies might have made a mistake, Sheriff Steve Zotos asked District Attorney Bob Gallagher to investigate. DEA spokesman Greg Williams said the DEA has a policy about agents drinking on duty, but declined to explain it. He would not say if the agents in the grill were on duty at the time, but assured the public that the incident will “be thoroughly investigated and the appropriate action will be taken.”

In a follow-up call to *SOF*, DEA spokesman Ron Wilson said the case “is extremely important to us. Public trust is something we can't afford to lose.” An internal investigation is ongoing, he said, and possible disciplinary sanctions may be forthcoming.

### Cowboys Will Be Cowboys

The DEA has not cornered the market among federal law enforcement agencies for boorish and inebriate bar-room behavior.

Police officers in Baltimore, Maryland, were called to the Rio Loco tavern in the 1000 block of South Charles Street when a brawl broke out at 2315 hours on Saturday, 10 April 1993. The fight began when ATF agent Kevin Patrick McCann, then 23, brandished his 9mm service pistol after getting into a dispute with another bar patron, according to police reports cited in the *Baltimore Sun*.

McCann, who lives in the 7900 block of Marfield Place in Parkville, refused to surrender his weapon when ordered to do so by two city police officers responding to the disturbance call. Instead of shooting him — which is probably what the ATF would have done, had the situation been reversed — the two cops squirted McCann in the face with pepper spray, the paper reported.

About “20 to 30 people [were] actively fighting inside the bar,” said Captain Howard Parrott of the department's south precinct. Police also had to use the spray on McCann's father and two brothers.

By then, Parrott told the *Sun*, the fight had moved outside on the sidewalk, where an estimated 75 to 100 people had gathered to watch and, in some cases, join in. When the dust and pepper spray settled, agent McCann

was charged with disorderly conduct and failing to obey the lawful order of a police officer. His father, Edmund McCann, 47, and 20-year-old Daniel McCann, the agent's brother, were charged with aggravated assault. Another brother, Michael R. McCann, was charged with disorderly conduct and failure to obey a police officer. In addition, two Baltimore men, Jerry Rowan and David Doyle, were charged with disorderly conduct.

McCann remained on “full-duty status” in the aftermath of the brawl, and remains on duty as of mid-July. The final disposition of the charges could not be precisely determined, and McCann declined to talk to *SOF*.

### Rendering Unto Reno

About a year ago, President Clinton signed the Religious Freedom Restoration Act, which mandates a “compelling state interest” for the federal government to interfere with acts of faith. Two millennia earlier, Jesus Christ had advised his followers to render unto Caesar what is Caesar's. Attorney General Janet Reno apparently doesn't know the difference.

As if to prove that the feds don't need a submachine gun and a battering ram to barge in and take what they want, the long arm of the federal law is trying to reach up the aisle of a religious temple and into the collection plate.

In 1992, Bruce and Nancy Young declared bankruptcy for their electrical contracting business in Minneapolis. Devoutly religious, and taking the words of the biblical prophet Malachi to heart, the Youngs had “tithed” 10% of their income to their church. They did so for years, through thick and thin.

But under a Minnesota tax law that allows creditors to confiscate a debtor's donations, a state court ordered the Crystal Evangelical Free Church to fork over \$13,450 the Youngs had tithed. Citing an invasion into the supposed freedom of religion in this country, the church refused.

Enter Janet Reno's so-called Justice Department. It issued an opinion that, for the first time, a church would have to cough up money a member had donated because the tax code was deemed to have “compelling state interest” over the Youngs' First Amendment right to freedom of religion. We'll see you in court, the church advised. And there the matter remains.

Meanwhile, like Pontius Pilate, Clinton and Reno have washed their hands of the matter. Justice Department spinmeisters have downplayed the dispute, suggesting that the Youngs gave money to their church that, because it was owed to creditors, was not really theirs to give. The issue, they say, is not as callous and constitutionally intrusive as it might appear.

Which brings to mind Mark Twain's assessment of Wagner's music: It's not as bad as it sounds.

Routinely confronted with the often-unsavory reputa-



When drunken DEA agents were 86'd by the waitress, one told Sedalia, Colorado, restaurant owner Jody Johnson, “I'm a cop and I could kill you right now and there is nothing you could do about it.” Photo: Linda McConnell, *Rocky Mountain News*

tions of their supporting witnesses, ATF agents regularly fall back on the old adage that if you want to convict the devil, you have to go to hell to get a witness. So where does one turn to find a witness to convict an innocent man? The ATF goes out of its way to cultivate such witnesses, most of them ditch slime that walk like men.

### A Snitch In Time

One such slippery specimen is John Gary Peeler. Instead of letting Peeler remain in prison, where he belongs, the ATF interceded to keep Peeler on the streets of Arkansas, where he actually gets paid to entrap honest people into unwitting violations of the law. Peeler's ATF paymasters can then concoct the empty case statistics that justify the financing of their dirty, dishonest business.

Peeler is best described as a drunken, big-mouthed punk. Obviously intoxicated in one video recorded in a pawn shop, Peeler bragged that although he has been convicted of numerous felonies, the ATF let him keep some of his firearms, in direct violation of federal law. He also bragged about other activities best not put in print.

One could also call Peeler a thief, a dope dealer, and a bomb-maker, according to a check of his police record. One might call him a mental case. He's been sent to federal prison psychiatric facilities at least four different times for various evaluations. He also can be violent, but he managed to win acquittal on a 1971 manslaughter charge.

At least he is well-connected among the families of highest social standing in his home state, though. While incarcerated at the Federal Correctional Institute in Fort Worth, Texas, in 1982 — this time for a list of federal weapons and theft charges — he became buddies with First Brother Roger Clinton, himself locked up for cocaine trafficking.

Around 1988, Peeler befriended — we use that term advisedly in Peeler's case — a pawn shop clerk in North Little Rock named Thomas E. Peterson, a law-abiding soul who'd never been in trouble with the law. Peterson is a friendly man of simple tastes who, at the time, was interested in guitars. Peeler began telling Peterson wild stories about exotic guns and encouraging him to read various spy novels.

Peeler was a poor study as a criminal. He never figured out that if you're too dumb to steal, the best advice is to get an honest job. Instead, he went to work for the ATF. A man of limited ability, he was not among the ATF's most productive or clever informants. Under pressure to turn some case stats, he apparently decided to serve up his supposed pal, Tom Peterson.

Peeler began trying to convince Peterson to make hand grenades from inert hulls, and to build a concealable .22-caliber pen gun. Peterson refused, but Peeler continued to press him for cooperation. In reality, Peeler could have done any of this himself, his rap sheet suggests, but he finally talked Peterson into helping with the completion of a pen gun concealed in a flashlight case. Peeler had to provide parts and instructions.

The next thing Peterson knew, he was arrested by ATF Special Agent Glen Jordan, Peeler's control agent, for violating the federal firearms law pertaining to "any other weapon."

Peterson told *SOF* that Jordan offered to make a deal: If Peterson would agree to become a regular ATF snitch,

Jordan would, in turn, not press the niggling pen gun charge. (He also acknowledged to Peterson that it was only Peeler's work as a paid ATF informant that kept Peeler out of prison.)

Protesting his innocence, Peterson said he felt no need to make a deal because he was innocent. Besides, he said he told Jordan, "I don't know any people involved with guns who are criminals."

"Who said they have to be criminals?" Peterson quoted Jordan as saying. The agent implied to Peterson that "we could make them into criminals by tricking them into breaking the law."

Contacted at his Little Rock office, Jordan declined *SOF*'s offer to tell his side of the story.

A three-count indictment led Peterson to U.S. District Court, where he was defended by court-appointed counsel, Clarence C. Cash, who decided to forego a jury trial and leave the verdict to Judge Garnett Thomas Eisele.

"The trial was remarkable in many respects," reporter Mara Leveritt wrote in the weekly *Arkansas Times*. "The gun in question, a flare device modified to shoot a single .22-caliber bullet, was sold to Peeler along with a knife for about \$60. When asked why the ATF would go to such lengths to prosecute a person with no criminal background for such an apparently minor infraction, agent Glen Jordan, who developed the case, replied, 'What he did violated the law.'"

(Jordan's bureaucratic dogma was run down by cosmic karma a few months later when he was shot by another ATF agent during the bureau's monumentally disastrous Waco raid. Jordan is the second of three agents seen clambering through a second-floor window in news footage of the raid. Evidence at the Branch Davidian trial indicates that Jordan and his boss in Little Rock, Bill Buford, were accidentally shot from behind by Special Agent Keith Constantino of the ATF's New Orleans office, who was the last man in the window.)

Jordan admitted at Peterson's trial that the ATF would pay Peeler as much as \$700 if Peterson was convicted. That admission led the judge to decide that such a financial arrangement cast serious doubt on Peeler's credibility because he had a monetary stake in Peterson's conviction, and thus had a motive to lie.

"Frankly, I am not much impressed with Mr. Peeler," Judge Eisele said. "... I do believe that he [Peeler] gave him [Peterson] the" pen gun parts and then Peeler "lied about it ... Where the government has induced the defendant to break the law, the government must prove beyond a reasonable doubt that the defendant was predisposed to violate the law before the government intervened."

At the end of one day of testimony, Eisele gave Special Agent Jordan an ass-chewing because the ATF's case "crossed the line" between an honest investigation and "entrapment of the innocent." The judge declared Peterson innocent and dismissed the charges.

*Editor's Note: Watch for James L. Pate's article revealing ATF's holy war against law-abiding gun dealers across the country. If you know of cases of law enforcement misconduct similar to those in this story, or if you read about such in your local newspaper, please pass it along to James Pate, c/o SOF, P.O. Box 693, Boulder, CO 80306. ✕*

# PAYING FOR PEACE

## Colombian Government Bribes Guerrillas To Stop The Killing

Text & Photos by  
Richard Emblin

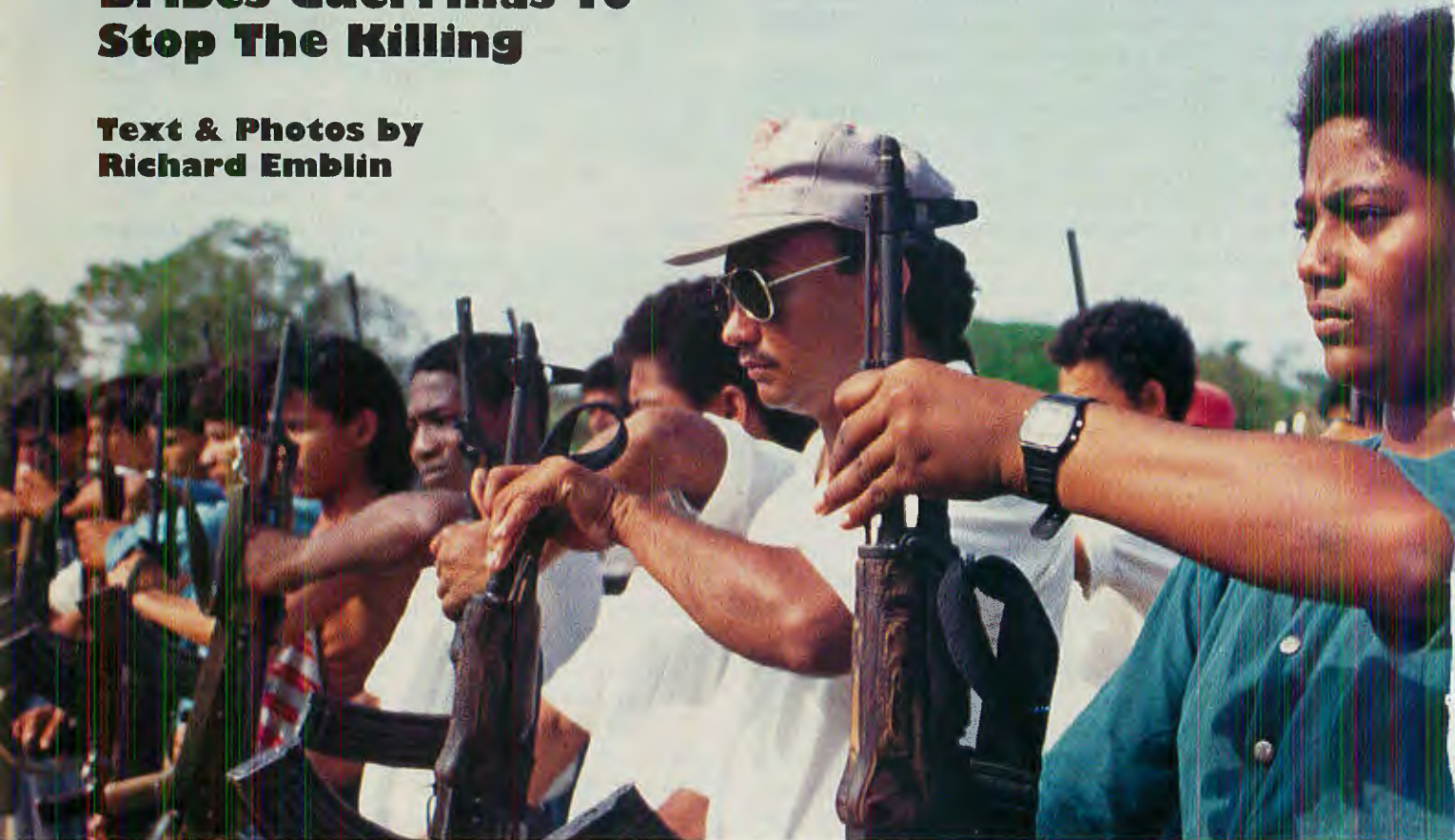

**When Sandra was a little girl**, her father singled her out from eight brothers and sisters as one with a will to fight. At the tender age of 13 she was recruited into the Maoist National Liberation Army (Spanish acronym ELN), and instead of struggling with books, classrooms and Girl Scouts, Sandra joined the struggle as a guerrilla.

After almost a decade of hiding-out in the hills, Sandra graduated from the splinter group Current of Social Renovation (CRS) as a *comandante*, a high-ranking warrior and expert in the art of kidnapping, extortion and murder. Her platoon of 40 guerrillas roamed the jungles of northern Colombia looking for easy targets. In order to fund their struggle they would conduct ambushes, often killing government soldiers to steal their Israeli-made Galils — the Colombian army's standard issue weapon.

Now the 25-year-old woman-warrior stood at the crossroads of her life. In the dusty village of "Flower of the Mountain" on Colombia's Caribbean coast, she held her Colt .38 Special for the last time. Planting a kiss on the

barrel, she placed it among a pile of M-16s, Chinese Type 56-1s, Remington hunting rifles, shotguns, Garands, Galils and UZIs. Sandra and 430 others from the CRS are the latest Colombian guerrillas to come down from the hills and talk peace.

Her companions from the CRS surrendered only 40 of more than 700 weapons in their possession — as a sign of goodwill and peace. The guerrillas were beginning the arduous process of reintegration into civilian life. Waging war in Colombia, however, has been a big business.

### **La Violencia**

A political assassination 46 years ago ignited a civil war in Colombia that lasted almost 30 years and killed more than 300,000 people. Known as *La Violencia*, a nationwide bloodbath erupted between the ruling conservative and liberal parties. As an alternative to the two political elites, the communist guerrilla insurgency was born.

The current peace process, culminating with the sym-



**Rebels stand in formation at weapons surrender in "Flower of the Mountain." CRS guerrillas turned in 40 of 700 weapons to symbolize their return to Colombian society.**

Symbolic surrender of arms by the CRS, has its roots in another assassination. As head of the Liberal Party and favored candidate to win the 1990 Colombian presidential elections, Luis Carlos Galan was gunned down by suspected assassins from Pablo Escobar's Medellin cocaine cartel. His death marked a turning point in a particularly bloody episode of the drug war.

Galan's reforms began in 1991 when newly elected President Cesar Gaviria Trujillo enacted the constitutional reforms envisioned by his slain predecessor. With narco-terrorism and guerrilla violence threatening to turn Colombia into utter chaos, Gaviria drafted a new constitution that, in effect, bribed fringe and extremist groups to enter the political process by not having to face legal reprisals for their past terrorist actions.

The first of these groups to seek official indemnity

from the government was the *Movimiento 19 Abril* (19 April Movement or M-19). Named after the date on which the National Popular Alliance party lost the 1970 elections, the organization comprised white-collar criminals notorious for kidnapping fellow white-collar executives.

In 1985, M-19 stormed the Palace of Justice in downtown Bogota, executed 11 of 24 supreme court justices and set the palace on fire, killing nearly 100 civilians. In order to avoid hefty jail terms, M-19 sought protection from the same government it had tried to overthrow by becoming a legitimate political party.

The experience has been a disaster for M-19. With no real political agenda, and the memory of the Palace of Justice massacre in the minds of most Colombians, M-19 is consistently wiped out at the polls. M-19 has, however, led the way for other fringe groups to politically reinsert themselves. The CRS is the last of the moderate guerrilla groups to use the peace clause as a means of fighting within the political system rather than against it.

The parent guerrilla organization of the CRS, the ELN,



is an independent insurgency group with strong links to the extremist Shining Path in Peru that has shown no signs of giving up the fight. The ELN is spearheaded by a renegade, ex-Catholic Spanish priest known as "The Priest Perez," who is thought to have 14,000 men under arms.

### Colombia's Shining Path

The ELN, like other guerrilla organizations, finances its war through kidnapping, extortion and drug protection for the cartels. There are an estimated 2,600 Colombian civilians held captive by guerrilla groups, including several foreigners snapped up who were in the wrong place at the wrong time. Among the kidnapped are a couple of American gold min-



After assassinating 11 supreme court justices and nearly 100 civilians, M-19 disarmed and entered the political process while government turned a blind eye to its past, paving the way for other groups.

ing engineers and European businessmen. According to one guerrilla, "The civilians are not kidnapped, they are just 'embargoed' for collecting revenue," — a twisted tax alternative to the methods used by government.

The ELN was quick to recognize the profits in the cocaine bonanza. It has become a leader in chemical engineering, and has recently made an important scientific discovery — liquid marijuana. Much more concentrated than the solid form, it is easier to transport and joins heroin as the guerrilla's latest export.

The group also continues to work alongside drug lords in refining the cocaine process, and it manages the clandestine airstrips deep in the Colombian jungle. The guerrillas are instrumental in shipping chemicals and cash across rugged terrain where the military has little or no presence. In 1993, the guerrilla insurgency received an estimated \$700 million from the drug trade.

Money has transformed the hard-line ELN into a multinational corpo-

ration where individual fronts receive extra benefits such as pensions, educational aids and subsidies for trips to Cuba. The bankrupt, dictatorial regime of Fidel Castro sponsors the ELN morally, educationally and militarily. For one ELN guerrilla, going to school in Cuba was a particularly enlightening experience, "We were



British Prime Minister Major tours oil facility. Vast oil reserves may rejuvenate Colombia's economy and provide new terrorist opportunities for guerrillas.

44 companions from 11 countries in Latin America and 28 different organizations. Some of our classroom buddies were from Palestine and Afghanistan."

### The Future Is Oil

The oil fields of Cusiana are estimated to be the largest single reserve in Central America, and whoever controls them controls Colombia. Not coincidentally, the ELN has consolidated its base of operations there.

The leading foreign oil companies in Cusiana: British Petroleum (BP), Lasmo Oil, Maxus, Triton and Occidental Petroleum Corp., are not encouraged by this development. To soothe their concerns, President Gaviria, using leftist guerrilla attacks as an excuse, has boosted military expenditures an additional \$100 million to create 10 new army companies — each comprises 80 counterinsurgency troops.

In addition, Colombia has created eight new intelligence networks, seven more army battalions and five air force tactical support units with Blackhawk helicopters and counterinsurgency aircraft. "These new fast-reaction forces will protect our investment in natural resources, as well as those of our foreign partners," Gaviria said at the Cusiana contract-signing ceremony.

However, as foreign companies continue to discover new oil deposits, the guerrillas continue to escalate

their offensive against the service companies and the petroleum infrastructure. The ELN's sole objective for the next decade is to paralyze Colombia's petroleum industry and destabilize the economy.

American and British oil companies, ready to reap immense profits from the Cusiana project, are taking the guerrilla objective seriously — hiring private security firms to protect their installations and personnel. With the largest stake in the Cusiana region — a \$2 billion investment — BP has contracted the British company Control Risks to handle 85% of their security.

Although Control Risks would not comment on their activities to *SOF*, the firm is run by three ex-SAS and Special Forces soldiers who, during the Cold War, ran convoys through the Soviet Union. Today they supervise the safe passage of all BP material coming in from coastal ports to the oil zone. Although the presence of ex-SpecOps troopers is categorically denied, *SOF* has learned that there are currently eight working on the oil rigs in the Cusiana exploration site.

Even with heightened military activity in the oil zone and the presence of foreign security experts, ELN guerrillas continue successfully tar-



Wide array of weapons were turned in during Colombian amnesty, from fully functioning Gallis and Kalashnikovs to worn out shotguns and hunting rifles.

geting the country's principal 600-mile crude oil export pipeline known as the *Cano-Limon Covenas*. In 1993, the ELN blew up the pipeline a record 240 times, causing unprecedented ecological disasters in the rivers and flood plains across Colombia.

So far this year, attacks against the *Cano-Limon Covenas* have diminished, but the ELN continue to strengthen their hold in the region by infiltrating oil unions and killing may-

Continued on page 73

# Farewell Chargin' Charlie



by Mike Peck

A visionary military thinker and founder of America's elite Delta Force, Col. Charlie Beckwith (left), shown here at Plei Me Special Forces camp, Vietnam, left his indelible mark on the SpecOps community. Photo: Joseph L. Galloway

**On 13 June 1994** Colonel Charlie A. Beckwith, perhaps the most unforgettable soldier I ever knew, departed for Valhalla. I join a host of others who mourn his untimely passing. Because of the impact he had upon me and my military career, I wish to honor him with a modest testimonial in the pages of a publication he respected and to which he often contributed both the wisdom of his observations and benefits of his experience.

As Kipling once wrote, "... I'll meet 'im later on, at the place where 'e is gone." I suppose that is inevitable, but when I first met "Chargin' Charlie" Beckwith at Fort Bragg in the early 60s, he was bigger than life. He was a newly promoted major, having recently returned from an exchange program with the British SAS. I was a newly commissioned second lieutenant, having just completed airborne, Ranger and unconventional warfare schools. Assigned to the 7th Special Forces Group, I was under the operational control of Maj. Beckwith, the group operations officer.

As our godfather, he dreamed up the most realistic and interesting training exercises I have ever experienced. It was fun to get up in the morning and go to work simply to see what mischief Charlie had dreamed up for us to do. Beckwith's training programs were unconventional in every respect, reflecting his experiences with the SAS.

I remember one exercise in particular we conducted in the Pisgah National Forest, west of Bragg. It was basically

a lift-and-carry ordeal. Various teams had to service a number of cache sites: lugging boxes of C-rations, 81mm mortar baseplates and boxes filled with sand and bricks from place to place. At 0-dark-30 my team finished, and we found our way to the pick-up point, humping along in a light drizzle, exhausted by the exertion.

Charlie was waiting there, toasting himself beside a small fire and several 2 1/2-ton trucks parked in a neat row. The major gruffly chased us away from his fire, so we made our own out of wet wood. By the time we finally got it going, the other teams had arrived and we piled onto the trucks.

Just as we settled in for the ride home, Beckwith bel-lowed for everyone to dismount and form back up into teams. He informed us the vehicles were there only to guide us back to our bivouac site. We trudged along in the rain for another five miles following empty trucks. It was psychological warfare at its worst. As everyone later admitted, however, it was superb training. Not only was it physically rigorous, but mentally and psychologically demanding as well — the best life insurance we could have received for our subsequent deployment to Vietnam.

In looking back, maybe Charlie was really living on borrowed time all along. While with the SAS in Malaya or Borneo, he contracted leptospirosis and refused evacu-

*Continued on page 83*

# Gardening At

**I never thought I'd live** to see it, but many Americans are seriously considering the idea of stockpiling guns and ammunition. Jolted by recent political events and the resulting shortages, many have already begun to take action.

For years, most Americans were content to ignore gun control efforts in the belief that the National Rifle Association (NRA) would handle the problem. Many were



Frighteningly unreasonable gun legislation has many Americans burying guns and contingency supplies in cache tubes such as this "Groundhog" system from NIC Law Enforcement Supply (Dept. SOF, 500 Flournoy Lucas Road, #3, Shreveport, LA 71106). But a cache is only as secure as the security you give it — better do the digging alone. Photo: NIC Inc.

content to let others fight their battles and never joined the NRA. Most considered gun control proposals a noisy political sideshow and doubted that any serious restrictions would get past the NRA's efforts to block them.

Things changed with the passage of the Brady Bill and

subsequent efforts such as the Feinstein Amendment. The ban on steel-cored 7.62x39mm ammunition, by Treasury fiat, hit just as worried gun owners were deciding that if they wanted an AK-47 or SKS they should get it while they could. The result was a panic and prices for guns and particularly ammunition skyrocketed as demand outstripped supply. It seemed that everyone decided that they needed to pick up 5,000 rounds "just in case." This buying frenzy overwhelmed suppliers accustomed to a slow, steady demand. The supply pipeline on ammunition from China is several months long and it was quite impossible for the market to adjust quickly enough.

Several readers [of *Machine Gun News*] asked for guidance on how to put their firearms into "long-term storage" so I offered the following *hypothetical* comments on how to make a weapons cache. These people weren't wanting to hide their collectible firearms from thieves, they wanted to hide weapons because they fear their own government. I'm not talking about Neo-Nazis or religious fanatics, just normal citizens. That is the really scary part.

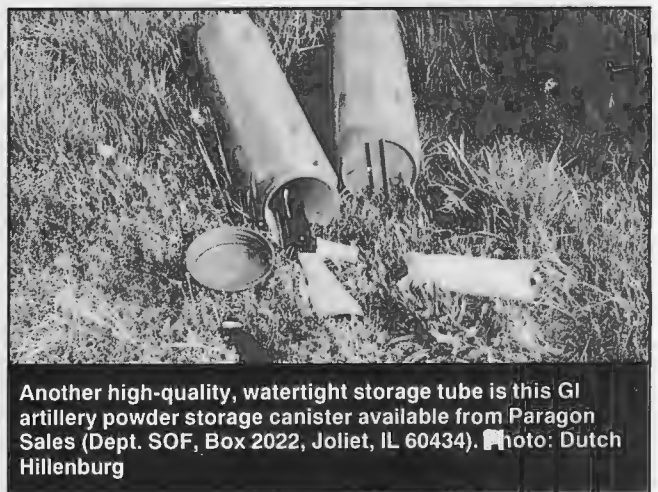

Another high-quality, watertight storage tube is this GI artillery powder storage canister available from Paragon Sales (Dept. SOF, Box 2022, Joliet, IL 60434). Photo: Dutch Hillenburg

First, you must always try to be realistic. You can't hide an armored division in your backyard. Consider this emergency stash in the same light as you do a good first aid kit. It will give you comfort to know that you have it available, but you don't need enough arms and ammunition for an infantry platoon any more than you need a hospital storeroom for a first aid kit. A friend nicknamed this type of stash a "Robinson Crusoe box," because it contains a few simple necessities for possible hard times.

Second, don't bury anything you can't forget about. Sure, that \$1,600 Colt AR-15 HBAR is a great weapon but don't even waste the time burying it. It just costs too damned much! Because it costs too much, you will dig it

# Night

## When Hiding Your Guns Becomes The Only Option

by Dutch Hillenberg



Digging a neat, vertical hole is facilitated with post-hole augers, which disturb the area less than shovels. Photo: from *Modern Weapons Caching* by Ragnar Benson, courtesy Paladin Press

up in a very short time to sell it *or just to make sure it's still OK*. We're talking about burying things with the hope that we never feel the need to dig them up.

### Disperse Your Cache

Third, don't put all your eggs in one basket. Plant several small "hard-times capsules" in scattered locations. Small caches are easier to conceal, because you disturb less when making the initial "deposit" and they are less likely to be found because they are small enough to be overlooked by a casual searcher. Remember, you are planning for *long-term storage*. You might not be able to recognize the exact spot 10 or 20 years later, or somebody could have built a housing suburb in what was a once pristine wilderness. This is what makes multiple stashes so important. Don't make the mistake of planting a cache where it can be washed away or exposed by the weather. Don't underestimate the value of having *decoy* stashes that can be written off if someone learns of your hidden weapons or if a stash is lost. People can find a cache by accidental discovery or someone may coerce you into leading them to it. On the subject of decoys, you can drive a search detail nuts by planting several fake capsules filled with old pipe and other metal debris. You can thwart searchers armed with metal detectors by spiking an area

with chunks of scrap metal. They may even give up!

Fourth and perhaps most important, don't ever tell anybody. I know that *sounds* really dumb, but it isn't. The easily caught criminals are arrested and convicted because they told somebody about their crimes. The only true secret is the one never shared. Don't tell your wife, your brother or your best friend that the cache even exists, much less the location. If you are concerned enough to believe that you need to secretly stockpile arms and ammunition as protection against an oppressive government, then you had better be really paranoid about hiding that secret. If you are correct and the government really becomes that oppressive, then you have just gone on to the Arms Cache Bonus Round where you are considered a revolutionary — and the ante really goes up. From personal experience as an eyewitness to two revolutions, revolutionaries get *shot* if they are discovered. *Keep your mouth shut* or somebody may shut it for you.

Fifth, don't hide anything that can be linked to you. Somebody may come looking to confiscate it someday. You could always admit that you bought it years before



As important as selecting the right hiding place and a good canister is ensuring that stashed goods will remain safe from corrosion within the cache. One excellent option is the Milspec long-term storage bags and desiccant available from Milstor (Dept. SOF, 1331 W. 135th Drive, Westminster, CO 80234). Photo: Milstor

Continued on page 81

## FULL AUTO

Continued from page 30

gets throughout the world. They are responding in a number of different areas. One of them is a recently introduced 12.7x99mm conversion kit for the GA1 20mm automatic cannon.

Recoil-operated and gas-assisted, the 12.7mm conversion kit's replacement parts consist of a .50-caliber cold hammer-forged barrel with an integral piston at the muzzle, a .50-caliber bolt head and 1,000 plastic link inserts. Additional components include a barrel jacket assembly and a replacement bullet (or "feed") ram for the gun's feed mechanism. The barrel jacket assembly consists of the barrel jacket, a gas gland and two clamps to attach the barrel jacket to the receiver. The gas gland has radial cooling fins and six ports to release propellant gases after the barrel has started rearward.

A gas gland was necessary be-

cause of the reduced recoil force generated by the .50 caliber Browning machine gun cartridge (approximately 1,500 newtons compared to 3,500 newtons of recoil energy developed by the 20x82mm round).

Conversion time is approximately five to seven minutes. Only a 6mm allen-head wrench is required. The .50 caliber barrel employs the same chamber-end interface (installed by shrink-fit) as the 20mm GA1 barrel. The cyclic rate is increased slightly to 750-800 rpm. Muzzle velocity is 2,920 fps (890 mps).

With this simple and cost-effective conversion kit, LIW has provided GA1 users with two weapons systems in one envelope. Lower cost .50 caliber ammunition can be employed for training and its combat-proven armor-piercing rounds can be effectively directed against lightly armored vehicles and boats, while the 20mm HEI/HEIT option is retained for serious anti-personnel work.

Since it started out as an aircraft cannon in 1934, the GA1 has

now been brought full circle by LIW with its announcement of a newly designed GA1 fixed-wing gunpod, manufactured from "lighter than aluminum, yet stronger than metal" carbon fiber materials. The GA1's low recoil impulse permits its installation on a number of light-weight aircraft and helicopters. Subjected to stringent qualification and flight clearance tests, the GA1 gunpod features a unique, removable spiral magazine with a 200-round capacity, an automatic electrical recocking mechanism, a recoil/brake cradle system, easy access doors, and link collection through the link chute. I have personally examined one of these gunpods and it appears to be as robust and reliable as all of the many LIW products I have tested.

Spent cartridge cases are ejected from the bottom of the pod. The spiral/helical magazine is assisted by an electric motor. A fail-safe safety pin provides 100% safety. Electrical control boxes furnish the firing control and safety mechanisms, as well as the recocking device.

## B.G.W.

### CLASS II MANUFACTURER OF SUPPRESSORS & EXOTIC WEAPON SYSTEMS FOR THE SILENT PROFESSIONAL.



Photo by Terry Williams



BGw's 300 Anabis Tactical Weapon System.

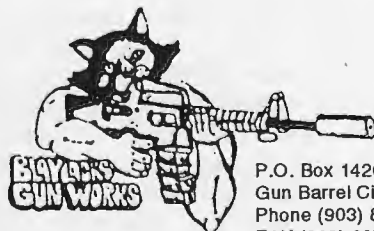

P.O. Box 1426  
Gun Barrel City, TX 75147  
Phone (903) 887-2655  
FAX (903) 887-4796

FOR CATALOG SEND \$2.00 or  
DEALERS SEND FFL & EIN

# PNEU-GUN™

## Air Powered Ballistic Baton



The "PNEU-GUN" (pronounced newgun) is a fistful of security. It is only 14 inches long when assembled and fires out a lead pellet filled "Shotbag" at a muzzle velocity of 250-300 f.p.s. One CO2 gas cartridge supplies sufficient energy to knock down a 300 lb. assailant 20 feet away. The "PNEU-GUN" air powered ballistic

baton is awesome! You have to see it in action to believe just how effective it really is. Don't confuse "PNEU-GUN" with old style "stun guns", "Un-Guns" or "Bean Bag Guns". There is no comparison in power, quality, range, effectiveness or sheer beauty of design. Keep on in your car, next to your bed or handy for that unexpected emergency. The "PNEU-GUN" air powered ballistic baton is the perfect alternative to a handgun. Legal, effective, yet safe to use.

**AG1... "PNEU-GUN" Airgun Kit...\$169.95**  
(Includes Airgun, 4 Shotbags, 6 CO2 cartridges, 10 gas check, 10 white end caps, loading cartridge, instruction book)

### SAP GLOVES

Made of soft, pliable, ling wearing leather. Has six ounces of powdered lead carefully inserted into the fist of each glove. High quality and available in three sizes, medium, large, and x-large.

**DAM... Sap  
Gloves...  
.\$44.95**

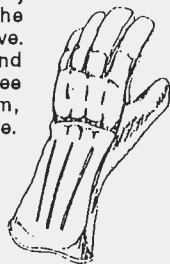

### PHONE CHECK (Telephone Bug Detector)

This unit has both a light emitting diode and a meter read out. Will tell you if your line is interrupted while in use. Will also automatically shut down the line if a bug is detected or an extension is picked up.

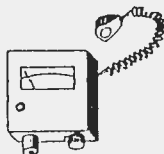

**ST1... Phone  
Check...\$79.95**

### THUNDER BLASTER

This new high tech, electrical self-defense weapon is the stun gun you've been waiting for! Now with a full 150,000 volts of increased power! This gun utilizes two 9-volt batteries and has dual coils. It has an extremely loud electrical sound so it is an even more effective deterrent than most other stun guns. The improved ergonomic hand grip is just perfect for a firm hold. Other features include an easier to use angular trigger, an on/off safety switch, a battery power indicator light, and a built-in belt clip. This gun will visually intimidate an attacker up to 20 feet away.



**TB-1... Thunder Blaster...\$119.95**

### THE TERMINATOR Tear Gas Alarm

The Terminator offers low-cost anti-burglary protection. When triggered by the trip line, 4 oz. of CN-type tear gas is discharged. Armored cast aluminum housing, replaceable canister, safety pin to prevent accidental discharge. 2,000 sq. ft. coverage.



**TM-1... The Terminator...\$59.95**

### TRANSMITTER (BUG DETECTOR)

Find hidden RF transmitters (bugs) planted in your home, office, car or attached to your telephone line. This device is designed to locate the most common type of electronic bugs. Frequency range of 1 MHz to 1,000 MHz.

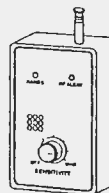

**TD-17... Bug Detector  
\$98.00**

### WIRE TAP DETECTOR

The Tap Detector detects series devices with a resistance of 61 ohms or more. It will also detect parallel devices with a resistance of 65 megohms or less. This device is the best full anti-wireless tap detector for the money. Compact, only 4-1/4" x 3-1/2" x 1-1/2"; and comes with all the necessary plugs, cords, adapters, battery and illustrated instruction manual. Buy this one to sweep the phone line and the Phone Check device to make sure no more taps are put on our lines!

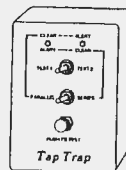

**TT-17... Tap...\$99.00**



### ALASKAN MAGNUM PepperGas®

Alaskan Magnum is an effective easy to use repellent that can be carried by hikers, joggers, backpackers or by anyone that is likely to encounter a violent attack. Utilizing a 10% concentration of pepper, Alaskan Magnum is sure to knock down any attacker. Alaskan Magnum comes in a 9 oz. fogger unit that has a range of 20 feet!

**PG9... 9 oz. Alaskan Magnum... \$49.95**

### PISTOL CROSSBOW

This compact pistol version of the deadly and silent crossbow is now available. This unit has fully adjustable sights, is amazingly accurate, comes in two different versions (50 lb. draw and 80 lb. draw) and comes with three practice arrows.

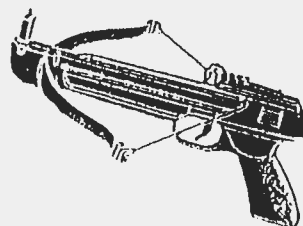

**PC1... 50 LB. DRAW... \$49.95  
PC2... 80 LB. DRAW... \$59.95**

#### ORDERING INFORMATION

By Mail: Mail coupon or separate sheet with payment or credit card information to:

**SONIC TECHNOLOGY, INC.** 10105 E. Via Linda, Scottsdale, AZ 85258

By Phone: Call 1-800-538-0787. Have all information ready.

Sonic Technology, Inc. does not warrant that you may legally possess or carry stun guns, pepper spray, etc. By ordering you acknowledge that you are an adult and there are no legal restrictions.

### BALLISTIC KNIFE

Congress outlawed the springs which enables this knife to shoot its blade which deadly force. The Ballistic Knife was invented by Russia and issued to their elite "Spetznazt" forces. This knife based on the original Soviet version which is able to fire its blade silently out of the knife handle with five times the force of a manual stab! This American made copy of far superior to the original and its unique firing ability was so effective, a federal law was made that outlawed the knife with a propelled blade.

Now you can get this knife in kit form. The handle and sheath are made of aircraft grade aluminum. The blade is tempered out of 41040 steel with a rockwell hardness of 56!

**FCC1... Ballistic Knife... \$139.95**

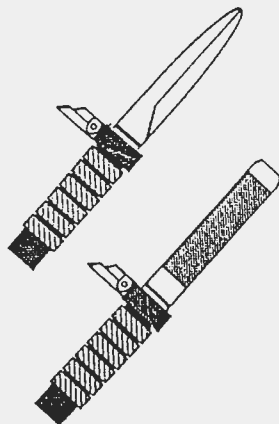

**SONIC TECHNOLOGY, INC.**

10105 E. Via Linda, Ste. 103-261  
Scottsdale, AZ 85258

**1-800-538-0787**

Qty.	Number	Description	Price

Charge My:  Visa  MC  Amex

Subtotal

Card #: \_\_\_\_\_

Shipping **\$5.00**

Exp. Date: \_\_\_\_\_

Total

Name: \_\_\_\_\_

Address: \_\_\_\_\_

City/State/Zip: \_\_\_\_\_

# MACHINE GUN MANUALS

## FN-FAL Auto Rifles 7.62 NATO

The complete manual for one of the most effective battle rifles ever made. If you own a FN-FAL you need this book. Fully illustrated with photos and drawings on almost every one of its 130 pages. 5 1/2"x8 1/2".

Item No. C-211...\$13.95

## F.N. F.A.L. Auto Rifles



## HK Assault Rifle Systems

The tough G3 rifle and its huge number of spinoffs has long been a favorite of soldiers, policemen, and civilians. Now firearms expert Duncan Long reveals the little known history behind this fascinating family of weapons, tracing its beginnings from the ashes of WWII to the present. The book goes on to show the probable direction HK designs will take in the future and tells why the G3 and its variants will remain popular during much of the next century. The author also examines customized versions of the .308, .223, and 9mm rifles and submachine guns and semiauto versions as well as other chamberings of the G3 spinoffs (like the HK-91/93/94, SR-9, SAR-3/8, SP-89, etc.). 8 1/2"x11", 128 pages, illus., soft cover.

Item No. C-9013.....\$27.95

## HK 91 & 93 Factory Manuals

A 52 page detailed manual for your HK rifle. You have just purchased a new or used rifle and did not receive a manual here is your chance to get one.

Item No. C-403 (HK 91, .308)....\$15.95

Item No. C-404 (HK 93, .223)....\$15.95



## The H&R Reising Submachine Gun

Designed for the Marines in World War II, the Reising was innovative and it fired the powerful .45 cartridge. Unfortunately, the design was not suited to the jungle environment that it was to be used in and it eventually found its way into the hands of war plant guards and the police. This book combines the rare original H&R factory manual with the military tech. manual. This is a must have book. Approx. 75 pp., 6"x9", photos, illus., softcover.

Item No. C-9127.....\$12.95

## Thompson Submachine Guns

Few arms in history have enjoyed the notoriety and publicity of the famous Thompson submachine guns. This book puts under one cover the most complete listing of practical and technical Tommy Gun information ever published. Reprints of U.S. and British military manuals plus an old Auto-Ordnance catalog add up to over 230 pages. illus. 5 1/2"x8 1/2", soft cover

Item No. C-284.....\$13.95



## UZI Submachine Gun

This comprehensive book gives fully illustrated details on both the wooden and folding metal stock models: functioning, detail disassembly and parts description, technical specifications and data, loading, firing, handling, zeroing, stoppages and more. 46 pages with nearly 60 large, clear photos & illustrations. 5 1/2"x8 1/2", softcover.

Item No. C-126.....\$7.95

## More MG Manuals

C-135 The M-14 Rifle ..... \$8.95  
8 1/2"x11", 50 pages, illus., soft cover.

C-274 M14/M14A1 Rifles & Rifle  
Marksmanship ..... \$14.95  
8 1/2"x11", 236 pages, illus., soft cover.

C-333 US Marine M-16A2 Manual .. \$16.95  
8 1/2"x11", 262 pages, illus., soft cover.

C-265 US Army M-16A1 Manual ..... \$14.95  
8 1/2"x11", 216 pages, illus., soft cover.

C-061 MAC Submachine Gun Operating  
Manual (MAC-10 & MAC-11) ..... \$6.95  
5 1/2"x8 1/2", 35 pages, illus., soft cover.

C-279 M-60 Machine Gun TM9-1215 \$14.95  
8 1/2"x11", 188 pages, illus., soft cover.

C-307 .50 Cal. Browning FM23-65 ... \$16.95  
8 1/2"x11", 207 pages, illus., soft cover.  
Browning M1918A2 (B.A.R.)

C-647 Maintenance Manual ..... \$10.00

C-648 Depot Manual..... \$10.00

Both 8 1/2"x11", appx. 50+ pages, illus., soft cover.

C-9002 German MG-34 ..... \$9.95  
5 1/2"x8 1/2", 70 pages, illus., soft cover.

The manuals in this ad are NOT conversion manuals. Most are enhanced reprints of government or manufacturer's manuals.

Credit Card Orders Only call our  
Toll-Free Order Line

1-800-852-4445

Customer Service

1-501-862-4984

Fax Number 1-501-862-9671

Allow 2 weeks for delivery



Sorry No C.O.D.'s

Add \$4.95 S&H to all orders plus an additional \$3.00 for orders to Canada. Other foreign add \$12.00 for first item & \$2.00 for each additional item.

Send Check or Money Order to:

**DELTA PRESS**

P.O. Box 1625 Dept.-SF56  
El Dorado, AR. 71731

Send \$3 for a 80 page color catalog (Free with order)

*DELTA, America's Elite Counterterrorist Force*, by Terry Griswold and D. M. Giangreco.



A great coffee-table book, if your tent has a coffee table. If not, it's one of the most insightful, open-source volumes yet published on Delta. Weapons, training, recruitment, history, air assets, national command struc-

## Laser Shot™ \$179 COMPLETE

INCLUDES:

- FREE SHIPPING\* • FREE MOUNT
- FREE BATTERY • FREE LASER HOLSTER

TOLL FREE

800-291-5511

### MOUNTS AVAILABLE FOR THESE BRAND NAME PISTOLS

AMT; Auto Ord; Beretta; Browning; Colt; CZ 75; Davis; Desert Eagle; FEG; FIE; Glock; H & K; Llama; Lorcin; Norinco; Phoenix; Rocky Mtn. Arms; Ruger; SIG Sauer; Smith & Wesson; Springfield; Star; Taurus; TZ75; Walther

Shotgun, Rifle and Revolver mounts also in stock.

Don't forget to ask about our new reinforced Laser Holsters.

Desert Eagle and H & K \$20 additional • Holster Not Included with Desert Eagle

\*UPS - Ground • Continental U.S. Only • C.O.D. Add \$5.00

- Blue or Stainless
- 1 Year Limited Warranty
- 3V Lithium Battery, up to 20 hours continuous
- Range 300+ yards
- <5mW

C.H. WORLDWIDE  
P.O. Box 2712  
San Ramon, CA 94583  
Tel 510-838-1665  
Fax 510-838-3172

**ANTI-NEW WORLD  
ORDER BOOKS by  
Robert K. Spear**

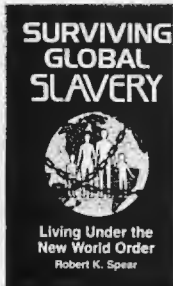

**Surviving  
Global Sla-  
very**  
Learn how to safe-  
guard your family  
from the impacts of  
a tyrannical world  
government.  
**\$9.95**

**Creating Covenant  
Communities**

Detailed info on how  
to relocate with com-  
mon sense to rural  
areas with other pa-  
triotis. **\$9.95**



add **\$3.00 S&H**

**UFD-SOF, P.O. Box 410,  
Leavenworth, KS 66048**

**BODY ARMOR  
THAT STOPS  
.44 MAGNUMS  
and weighs only 3-lbs!**



SOFT, COMFORTABLE, CONCEALABLE BODY  
ARMOR MADE WITH 18 LAYERS OF DUPONT  
KEVLAR (U.S. ARMORS IIA VEST HAS 14  
LAYERS, ARMO-TECH HAS 15 LAYERS)  
MED: \$149.99 LRG: \$189.99 XLRG: \$259.99  
Adjustable ballistic panel carriers available  
in white, navy, OD and brown.  
**5-YEAR WARRANTY ON BALLISTICS**  
Prepaid orders include shipping. \$10 charge for  
CODs. One week shipping for stock sizes. State  
height and weight when ordering. Money orders  
and certified checks accepted. CODs cash only.  
**MICHIGAN BODY ARMOR**  
P.O. BOX 243 LATHRUP VILLAGE, MI 48076 313-788-2234

ture are all illustrated with color pho-  
tos and case histories. Excellent  
source material; 129 pages of good  
reading. \$14.95 from Motorbooks In-  
ternational, 729 Prospect Ave.,  
Osceola, WI 54020.

**UNITED STATES MILITARY  
AWARDS, 1939 to 1994**, by Col.  
Frank Foster and Lawrence Borts.

The definitive work, comple-  
mented by top-notch color photog-  
raphy, covering virtually every  
ribbon and medal awarded by the  
Army, Navy, Marines, Air Force,  
Coast Guard and Merchant Marine.  
Indexed, 80 pages, it includes his-  
tory and criteria for awards, proto-  
cols for wear, interservice medals,  
foreign medals, etc. Hardcover.  
\$24.95 from Medals of America  
Press Ltd., 1929 Fairview Road,  
Fountain Inn, SC 29644-9137.

**I, WITNESS!**, by Thomas F.  
Macris.

An effective workbook for build-  
ing a composite sketch from mem-  
ory. Written by one of the top police  
artists in the country, this pithy little  
volume can be filled out by wit-  
nesses immediately after an inci-  
dent. Thorough and structured, the  
book contains visual aids to help a  
witness articulate and accurately  
reproduce the essence of the appear-  
ance of each facial feature. Soft-  
cover. \$5.95 postpaid from Visatex  
Corp., 1745 Dell Ave., Campbell,  
CA 95008. ☒

**RUGER/LEUPOLD**

*Continued from page 53*

M-77 Mark II Countersniper Rifle  
sent to us for test and evaluation was  
equipped with a Harris Model L Se-  
ries S bipod that weighs 14 ounces.  
This is the pivoting, or hinged, base  
model and has a suggested list price  
of \$74.

The pivoting base provides the  
shooter with the ability to level the  
reticle pattern when firing from un-  
even terrain. The base can be rotated  
approximately 20 degrees in either  
direction. The legs, constructed from  
aluminum tubing, have a friction lock  
that permits adjustment of the com-  
mand height (the distance from the

**HANDSTRAPS™**

*Strengthens  
your fingers,  
thumbs,  
hands,  
wrists,  
and  
forearms.*

**DEVELOP THE DEATHGRIP  
WITH THE BEST HAND  
STRENGTHENING METHOD IN  
THE WORLD!**

FORGET THE OTHER STUFF THEY  
DON'T WORK. YOU NEED THIS. THE  
HANDSTRAPS COURSE WILL TRIPLE  
YOUR GRIP STRENGTH IN 30 DAYS. IT'S  
EASY, NOW THAT THE BARBELL  
PRINCIPLE OF ADDING WEIGHT AS  
YOUR STRENGTH DEVELOPS HAS  
BEEN APPLIED TO THE HANDS. WANT  
THE STRONGEST GRIP IN THE WORD?  
YES! AS A MAN OF ACTION,  
MY LIFE IS IN MY HANDS.  
Send your name, address, and 14.95  
+ 2.00 S/H to:

**HANDSTRAPS COMPANY**  
DEPT. A, P.O. BOX 32547  
CLEVELAND, OHIO 44132  
*Used by professional athletes worldwide*  
**30 DAY MONEY BACK GUARANTEE**

**FREE  
BROCHURE**

**Hear the hidden world.**  
Hear the hidden world with the original  
**Bionic Ear®**. Amplify and pinpoint sounds  
while reducing background noise. Used by  
search and rescue teams to locate people lost  
in rough terrain. Call 1-800-533-3277.

**BionicEar®**  
Silver Creek Industries, P.O. Box 1988, Manitowoc, WI 54221-1988



# ITS GROUNDHOG DAY!

For those of us living under the shadow of gun control...  
Hide your weapons **WHILE YOU CAN!**

## GROUNDHOG™ UNDERGROUND STORAGE SYSTEMS

**GROUNDHOG™** the only container available today that will accept the AR15-M16 family of weapons without disassembly; at 58"x10" (@5 feet/4554 cubic inches), the **Groundhog™** easily holds four AR15's, two AK-47's and 2300 rounds ammo, with plenty of extra room for handguns or anything else you want to safeguard! Largest underground storage safe available today at a reasonable cost!

**GROUNDHOG, JR™** at 58"x8" (2914 cubic") holds four AK-47's and 1500 rounds ammo. **GROUNDHOG™ AMMO SAFE** (40"x10") Holds *three* standard military ammo boxes! **GROUNDHOG, JR™ AMMO SAFE** (40"x8") to store handguns and other valuables.

\*Airtight, watertight, nonmagnetic subterranean safes\*

\*Half pound desiccant included for added moisture removal/absorption\*

\*Heavy-duty PVC materials \*Built in the USA\*Complete instructions included.

**DON'T LET THEM BURY YOUR RIGHT TO KEEP & BEAR ARMS**

Groundhog™.....#GH1.....\$94.95    Groundhog, JR™.....#GH2.....\$59.95  
Groundhog Ammo Safe™.....#GH3...\$64.95    Groundhog, JR. Ammo Safe™.....#GH4...\$44.95  
Extra Desiccant (Half lb.).....#GH5...\$4.95

Shipping \$15.00 for GH1&GH3 and \$10.00 for GH2&GH4 to lower 48 states

Send for your **Groundhog™** Safe using  
Check, Money Order or call  
for VISA/MasterCard orders.  
Free 144 page color catalog with order!

N.I.C, Inc.--PO Box 5950-Dept. FGH  
Shreveport, LA 71135-5950  
CALL (318)688-1365 or FAX (318)688-1367



bore's axis to the ground) from 9 to 13 inches. The Harris bipod is not an object of great beauty, but it works, is reasonably priced and provides a firm shooting platform.

One of the most important factors in the sniping equation is the selection of accurate, match-grade ammunition. For example, Chinese 147-grain FMJ ball (headstamped 81 92), while great for cranking through belt-fed machine guns, will produce no better than 4-inch groups from any precision turn-bolt I have fired. Its future importation, I might add, has been banned, not to punish China or its PLA (People's Liberation Army), but to punish American gun owners.

When it comes to 7.62x51mm-caliber accuracy, Federal's 308M cartridge (Federal Cartridge Co., Dept. SOF, 900 Ehlen Drive, Anoka, MN 55303; phone: 612-323-2300, fax: 612-323-2506) is the standard by which all others must be measured. It features the superb Sierra 168-grain BTHP Matchking bullet. Developed for 300-meter shooting in international matches, this remarkable Boat-Tail Hollow-Point bullet has been winning competitions ever since it was introduced in 1959. It was used by the gold medal winner in the 1968 Olympics and set a new Wimbledon record at 200-15 Xs in 1983 at Camp Perry. It remains far and away the most popular bullet among law-enforcement selected marksmen in the United States.

With Federal 308M ammunition, the Ruger Countersniper rifle and Leupold Vari-X III 3.5X-10X scope combination will consistently shoot under 1 MOA from the bench. A member of *SOF's* team staff fired a 0.3 MOA group, which borders on incredulous. Using this rifle, scope and ammunition, eight different members of the Emma Gees hit 24 consecutive sticks of dynamite at distances of 100 to 150 meters from the prone, sitting and off-hand positions before a single miss was recorded.

This is outstanding accuracy. Leupold's Vari-X III 3.5X-10X Tactical variable power scope is almost half the price of any of their top-of-the-line Mark 4 scopes. Ruger's M-77 Mark II Countersniper Rifle carries a suggested retail price of only \$665, complete with 1-inch scope rings with integral bases and

# TITANIUM

"The **COMPETITIVE** edge. . ."™

\$34.95 Fits AR-15 & M/16 style Rifles

\$21.95

Fits 1911 pistols  
.45 ACP &  
.38 Super



You have already discovered the advantages of our Titanium Firing Pins for 1911 pistols. **NOW YOU CAN ADD THE SAME MAGIC** to your competition AR-15® & M/16®

Improve scores, reduce slam fires, discover what **QUICK** really means!  
Cut lock time . . . & get on to the next target!

Proudly Made in the U.S.A.

Retail order desk:  
1-800-444-1911  
(Add \$3<sup>00</sup> S/H per order)



**Quality Machining**  
INCORPORATED

"OUR NAME SAYS IT ALL"™

P.O. Box 129 • Sherwood, Oregon 97140

24 HOUR FAX LINE FOR ORDERS & DEALER INQUIRIES: 1-503-590-3657  
(Product Information: 1-503-590-3636)

operator's manual, and represents an incredible value for the money as do all of their products. Law enforcement agencies with restricted budgets should be attracted to this excellent Ruger/Leupold countersniper system as it is less than a third the cost of most so-called "customized" sniper systems with Teutonic optical sights. Other accessories include Butler Creek flip-up scope lens covers, sling and QD sling swivels, cleaning kit including cleaning rod guide and Pelican or Alpine hard cases. ❧

## I WAS THERE

*Continued from page 15*

Suddenly, we hit more turbulence, violently bouncing the C-130. It was so strong it jarred the plane's back-ramp locking mechanism loose. Apparently it hadn't been fully locked, and the ramp, with the CO still sitting on it, started to go down. He panicked, screaming, "Help! Help me! God! Someone help! I can't get up!" I heard him yelling, looked up and started laughing. I was too damn sick to help him anyway.

The aircraft's loadmaster came to his rescue, pulling him up and off the ramp. The aircrew then struggled to get the ramp back up with a mechanical hand lever and manually locked it in place.

My commander stood there sweating, scared shitless and just about ready to cry. He turned to me and angrily said, "You asshole, why didn't you help me?" I was still so sick all I could do was look up at him and say, "Why should I, Sir? You had a fucking parachute on!"

He never forgave me for that. ❧

## PAYING FOR PEACE

*Continued from page 64*

ors of new boomtowns — 16 local leaders have been assassinated this year. The national police, in an unusual move, have had to put at least four communities under their protection to prevent any further esca-

# New assault rifle case

from



AK47/MAK90 and  
Colt AR15 Lightweight

Shooting Systems sets the world standard for assault rifle cases. Padded with thick foam for maximum protection yet light weight. Full-length zipper with padded internal flap for additional protection. On the exterior is a set of easy access magazine pockets, plus a large accessory pocket. Wide handles and shoulder strap. Available in black or Woodland camouflage. Length 36" \$75.50

**SHOOTING SYSTEMS**  
GROUP INC. ®

Formerly known as Assault Systems

1075 Headquarters Park, Dept SF  
Fenton, MO 63026-2478  
Toll-Free 1-800-325-3049

Questions? Call our toll-free number.  
We've got the answers—our complete  
24-page, full line catalog, brochures,  
brand new products.

**THE FIRST TEAM**



**Safari Arms, INCORPORATED**

620 - 624 OLD PACIFIC HWY SE • OLYMPIA, WA 98513  
TELEPHONE (206) 459-7940 • FAX (206) 491-3447

**Carry-Comp .45s** now available from **Safari Arms** — with the Wil Schueman-designed hybrid compensator system. Adds no length or significant weight to the pistol, yet drastically reduces recoil. **Right:** Matchmaster and Enforcer Carry-Comps

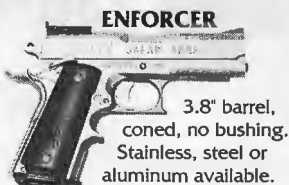

**ENFORCER**

3.8" barrel, coned, no bushing. Stainless, steel or aluminum available.

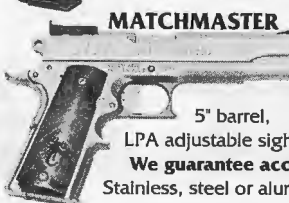

**MATCHMASTER**

5" barrel, LPA adjustable sights. **We guarantee accuracy.** Stainless, steel or aluminum.

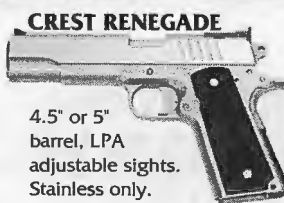

**CREST RENEGADE**

4.5" or 5" barrel, LPA adjustable sights. Stainless only.

**At last!** A custom quality **left-handed .45 ACP** at a reasonable price for **LEFT-HANDED** shooters. Tired of catching hot brass in your teeth? Try the **RENEGADE!**

lation in the war.

The guerrillas have also had some success in extorting the powerful oil companies. Out of desperation, some have found it easier to simply pay off the insurgents to prevent further attacks.

### Price Of Peace

When the young men and women of the CRS surrendered their guns — though not their ideals — beneath the burning midday sun, they did so with apprehension. Their hopes of reentering society as everyday citizens was mixed with the sadness of leaving a nomadic lifestyle. The uncertainty of how to earn a living or protect themselves from old enemies without the comfort of weapons would haunt them now. Even their old allies, the ELN, feel betrayed by the CRS because of their successful peacemaking with the government.

For the 430 members of the ex-guerrilla force, the government is committed to paying each person a monthly salary of \$350 for the first year of their return to civilian life. After which the government will provide each former guerrilla a low-interest loan of \$5,000, so that these

ex-warriors can team-up and start small business ventures. The three-year peace process with the guerrillas from the CRS cost the government \$40 million — a hefty sum to pay for 430 men and women. In the words of Tomas Concha, presidential adviser for the reintegration program, “Instead of asking for what price peace, we should ask ourselves, what’s the price of war?”

*Richard Emblin is a professional photojournalist who has lived in Colombia for the past four years. ✕*

### WHO LASTS WINS

*Continued from page 57*

absolute mayhem. I grabbed my pack and webbing and ran for cover. I crouched and aimed into darkness. Our supervisor told us the area was no longer secure and we had to move north. I checked my watch — I had been asleep for 20 minutes. After about two hours of marching I casually inquired about rations. “Next ren-

dezvous,” I was told.

We marched all that day and into the night. Seventy hours had passed without sleep. I was given the point and told to look out for unfriendlies. Staggering through scrub, I walked straight past a supervisor sitting under a tent. Beside him was a large trailer with one wheel. With typical army originality, we were told to get the trailer from point A to point B in C hours, C being just short of the time it takes a team of Olympic athletes to achieve the task.

Halfway through the exercise I saw another ranger wander into the bush for a leak. When he thought he was out of sight, he placed his arm in a tree stump and jerked it back sharply. He grimaced and walked back toward the patrol. Halfway back, he fell and began to scream in pain. An ambulance took him away. Four left to carry the trailer.

Days began to melt into nights. I confused sunrises and sunsets. Patrolling was a blind stagger through scrub. We would sleep only to be awakened minutes later to some manufactured emergency. Food was always “at the next rendezvous” and the end was

# RECOIL COMPENSATORS

INSTALLS EASY WITH NO ALTERATION OF WEAPON!

*Quality units to control muzzle rise due to recoil.*

**MAK-90**

**\$34<sup>95</sup>**



#XAK2035 (Blue)

**M11/9**

**\$34<sup>95</sup>**



#X1519 (Blue)

**SKS**

**\$44<sup>95</sup>**



#X2055 (Blue)

**MINI-14/30**

**\$42<sup>95</sup>**

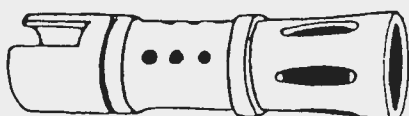

#X1530 (Mini 14 Blue)  
#X1531 (Mini 14 Nickel)  
#X1532 (Mini 30 Blue)

**AK-47**

**\$36<sup>95</sup>**

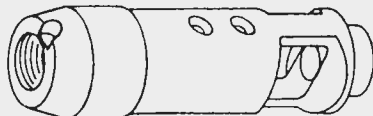

#X2005 (Blue)

**10/22**

**\$42<sup>95</sup>**

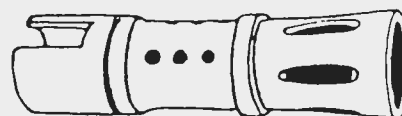

#X2204-B (Blue)  
#X2204-N (Nickel)



**ORDERS ONLY CALL**  
**1-800-239-7435**  
205-222-1931 / FAX 205-222-2309

SHIPPING CHART	ADD
0.00 - 35.00	4.95
35.01 - 60.00	5.95
60.01 - 100.00	6.95
100.01 - 150.00	7.95
150.01 or over	8.95

\*AK, HI, Canadian orders add \$4.00.

**CALL TOLL FREE TO ORDER**  
**OR SEND CHECK OR MONEY ORDER TO:**  
**CROWN SPECIALTY CO.**  
DEPT. SF, P.O. BOX 488 • ANDALUSIA, AL 36420

never in sight. Fatigue, mixed with hunger, created a curious euphoria. Did I actually want to be a member of the SAS, or did I simply want the glory that comes with belonging to an elite unit?

We were told to move a series of poles, tires and tarps to a "secret" hillside destination. There were only three rangers left in my patrol by this stage, so we made two huge stretchers and carried one up about 30 meters, then went back for the others. The destination was 9km away. After an hour it started to rain. Moving up the slightest incline became impossible; the ground kept giving way underfoot. The supervisor watched silently. Three of us toiled on for another hour, covering only 200 meters.

Finally we sat down in the mud, totally dejected. We started to talk about leaving the stretchers. Our supervisor peered over us with indignation. "Never in my career," he ranted, "have I seen such a pathetic display. You're not good enough to be soldiers in the SAS. You're not even good enough to be in the armed forces. You're

shit. All of you are shit."

Saturated, abused, blistered and bloody, I decided he was right. After more than 20 days of sleep and food deprivation, relentless physical and mental torment, I drew a similar conclusion: I was shit. I swore to withdraw at the next destination. But our next destination was our original camp. All 12 rangers were called into a room where a gruff-looking sergeant stood in front of a flimsy desk. "Congratulations men," he told us. "You've passed the selection course for the SAS."

*It's over*, I thought. *This can't be another trick.* "You can now hold your head a little higher."

*It's really over.* "And walk a little taller."

*It's truly finished.* "Soon you'll be members of the regiment. And remember the SAS motto: Who dares wins."

*Who cares who wins?* I thought.

*Todd Cole is a senior editor at the Australian edition of Penthouse magazine, and a former member of the Australian SAS. ✕*

## JUSTICE ON HOLIDAY

Continued from page 39

arguments. Douglas Tinker told the court that "this country started with a Constitution that provided a jury to protect citizens from the government," and warned that if the judge reinstated Count Three, "It's an erosion of the right of these people to be sentenced by a jury of their peers."

Chief prosecutor Ray Jahn called for maximum sentences. He charged that the eight Davidians were "as much religious terrorists as the people who blew up the barracks in Lebanon, the people who blew up the World Trade Center and Pan Am 103." As if the whole proceeding were a medieval heresy trial, Jahn also alleged the Davidian's "misguided interpretation of what they perceive to be the word of God" was to blame for the whole affair. Jahn made it clear that interpretations of the word of God by ordinary citizens must now pass muster by the federal courts.

After Jahn had spoken his piece,

**"Special Purchase Allows Price Breakthrough"**

**Catalog \$4<sup>00</sup>**  
**Product Video \$10<sup>00</sup>**

## The Leader In Technology for S<sup>+</sup>ighting, Sighting, Photographing and Vid<sup>+</sup>otaping In The Dark

### NIGHT VISION WEAPON SIGHTS

I GEN.  
**AN/PVS-2B Weapon Sight**

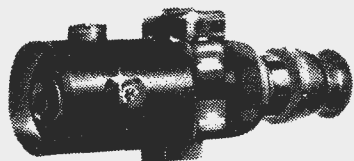

II & III GEN.\*  
**AN/PVS-4  
Weapon Sight**  
**\$2850<sup>00</sup>**

• Photo/Video Adapter Included  
• New with Excellent Cond. Intensifier  
\*III Gen. POR



**\$1695<sup>00</sup>**

• Includes Weapon Mounting &  
Photo/Video Adapter.

### POCKETSCOPE

II & III GEN.\*  
**NIGHT EXPLORER**

• Photo/Video Adapter Included  
• New with Excellent Cond. Intensifier  
• A Choice of Two Lenses from  
1X, 2X or 3X \* III Gen. P.O.R.

Grade I **\$1550<sup>00</sup>**  
Grade 2 **\$1350<sup>00</sup>**



### NIGHT VISION GOGGLES

II GEN.  
**NVG-500**

**Starlight Goggles**

• Includes: Cold Weather Heaters  
• Excellent Cond.

Grade I **\$2450<sup>00</sup>**  
Grade 2 **\$2250<sup>00</sup>**

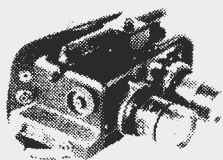

II GEN.  
**SC/PVS-700  
Mono-Tube Goggle**

**\$2295<sup>00</sup>**

• Excellent Cond.  
• 2X & 3X Lens Included

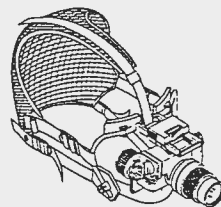

III GEN.  
**AN/PVS-7B  
Mono-Tube Goggle**

• 3X Add-on Available  
**\$4500<sup>00</sup>**

(New - Standard)

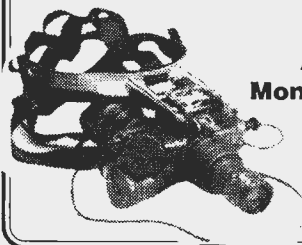

## STANO Components

P.O. Box 2048 • Carson City, Nevada 89702 • (702) 246-5281 / (702) 246-5283 / Fax (702) 246-5211

# GUNRUNNER®



## READY WHEN YOU

want to draw your gun from the "Uncle Mike's" GunRunner® Fanny Pack Holster, just pull sharply on the front to release Velcro® strip that seals the firearm inside the rear compartment.

Compact GunMate Belt Pack Holster has rear gun compartment, center pouch for wallet and front pocket for badge, etc. Only 7¾" x 4¾" x 1½".



## SET GRASP THE GUN INSIDE

the compartment. There's no inner holster to slow you down. Three sizes fit a wide variety of guns. Five colors avoid a pattern of recognition.

## GO! DRAW THE GUN SWIFTLY,

straight out of the GunRunner. When you reholster, just shove the gun inside, slap the Velcro shut, all with one hand. Middle compartment for ammo and gear, front compartment has badge holder.

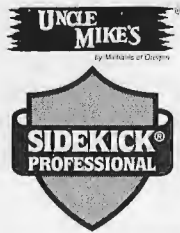

See them at your gun or sporting goods dealer. Or send \$2 for our new 48-page catalog to Michaels of Oregon, Dept. SOF, P.O. Box 13010, Portland, OR 97213.

the Judge had not one, but two legal tricks up his sleeve — and he decided to play them both:

"These defendants, and other adult Branch Davidians," Judge Smith said from the bench, "engaged in a conspiracy to cause the deaths of federal agents." Not only did judge Smith find them guilty of conspiracy — despite the jury's acquittal — he even put his finding into the mouths of the jurors, some of whom were in the courtroom — gagging. "By its verdict, convicting the defendants of violating Section 924(c)(1) — Count Three — the jury found that they were members of a conspiracy to murder federal agents ..." the judge declared.

Smith also revealed that the Davidians fired the first shots of the 28 February raid — though nothing of the kind had been proven by testimony — and again, in defiance of all known evidence, found that "by a combination of suicide and murder inflicted by Davidian upon Davidian, all but a handful of the Davidians were killed." In a word, he found the eight accused Davidians guilty of setting the fire in which their wives, sisters, children and mothers perished! Yet when the blaze erupted, three of them were already in jail, and a fourth was in hiding!

### Preponderance Of Evidence

The judge justified his dubious findings on a principle unknown to most American citizens. At trial, the government must prove its charges beyond the shadow of a reasonable doubt, but at sentencing, a federal judge may use a different and less demanding standard, called "the preponderance of the evidence." Or in other words, you can be acquitted by a jury, but convicted by a judge — for the very same offense, on the basis of the very same evidence! It's legal, and every now and then, federal judges stoop low enough to do it.

Having judicially reinstated Count Three by pulling the conspiracy charge out of the trash heap, Judge Smith then set about the very serious business of sending the defendants to prison.

According to the law, the reinstated Count Three convictions could have produced prison terms of three different lengths: five years for using an ordinary firearm, 10 years for use of

**Compliments of  
Mikhail Gorbachev...**

**Warsaw Pact Military Binoculars  
Never Before Available in the West.**

### EDF 7X40 - (manufactured by Carl Zeiss-Jena)

Used by East German border guards along the Berlin Wall, these are thought to be the finest roof prism binoculars ever made. Current issue throughout Eastern Bloc; never before offered to civilian market. Astounding optical clarity and brightness. Includes rangefinder reticle with tritium illuminator, infrared night vision filter, rubber armor, complete weatherproofing. Built to extremely rigorous military specs. Each piece new in the box with English instructions and individual serial number. Money back guarantee if not satisfied.

### Exceptional price of \$499 includes a lifetime warranty.

CA residents add 7.75% sales tax. Quantities are extremely limited, however; order now to ensure delivery. Sorry- no more than two pieces per customer.

Call SCM Corporation **1-800-225-9407**

AMERICAN

*Survival*



## TRAINING & PREPAREDNESS VHS VIDEOS

**TIMES ARE GETTING HARDER AND SO CAN YOU!**

Our NEW! 3-Volume Video Series, is specially geared with the survivalist in mind. Let our knowledgeable instructors show you useful techniques with step-by-step instructions on various survival topics.

**VOLUME-1, VHS, Color, 1hr., 20 min. \$48.95**  
Home Security Methods, Traps & Trapping Game, Edible Foods & Plants, Making Improvised Lethal Weapons, Weapons Handling, Types & Their Uses, Weapons Maintenance & Care.

**VOLUME-2, VHS, Color, 1hr., 10 min. \$48.95**  
Survival First Aid, Hypothermia, Building Survival Shelters, Fire Making Methods, Locating Water & Purification Methods, Survival Conditioning, Personal Defense Tactics.

**VOLUME-3, VHS, Color, 1hr., 20 min. \$48.95**  
How-To Knot, Hitch & Lash for Survival, Land Navigation, Distress Signals, Bearings Without Compass, Dehydrating Your Own Survival Foods, The Art of Knife Fighting Techniques & Tactics.

**ACT NOW AND RECEIVE VOLS. 1, 2 & 3 FOR THE LOW INTRODUCTORY PRICE OF ONLY**

**\$98<sup>50</sup>**

This introductory offer may expire without notice.

For speedy delivery (2-3 weeks) please mail certified check or money order to:

**AMERICAN SURVIVAL FILMS**

4759 Palm Avenue, Studio 226, Hialeah, Florida 33012

Tel. 305.884.0344 · Fax 305.885-9669

**ORDERING INSTRUCTIONS:**

\*Include \$5.00 per tape for shipping & handling, or \$8.50 for 3-vol. set. All orders shipped by priority mail.

Personal checks require usual clearing period.

Florida residents add 6.5% sales tax.

Dealer, school & institution inquiries invited

**ENCLOSE THIS AD FOR YOUR FREE SURVIVAL TOOL.**



SOF-894

## Clinton is coming!



Are you ready?

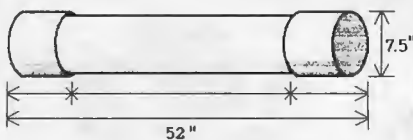

- \*Water/air tight burial/storage safes.
- \*Can hold up to three firearms.
- \*Non-magnetic/Non-metallic.
- \*Extra heavy PVC construction.
- \*Made here in the U.S.A.!!!
- \*Choice of dark green or black.
- \*17" pistol case, only \$39.95.
- \*52" rifle case, only \$59.95.
- \*Custom sizes available.
- \*Dealer's inquiries welcome.

Please add \$12.00 for S&H, \$18.00 for AK or HL.  
For immediate service, please pay by money order or cashier's check, personal check allow two weeks.

**Bereit Industries**  
P.O. Box 130304 Tampa, FL. 33681-0304  
TEL: (813)832-3191



a sawed-off shotgun or rifle, and 30 years for using an automatic weapon.

Some of the Davidians had only covered during the assault on Mount Carmel, and some had taken up ordinary weapons. During his allocution statement, Fatta told the judge that, "I have never bought parts for, or converted, owned or fired an automatic weapon." Whitecliff declared that, "I've never owned an automatic weapon; I've never fired an automatic weapon; I don't know what one consists of." But if prosecution witnesses can be believed, some of the Davidians had used automatic weapons, just as the ATF agents had.

Defense attorneys argued that, according to the only legal precedent that exists, juries, not judges, must determine what kind of weapon, if any, each defendant was guilty of using. Since Judge Smith had disbanded the jury at the end of the trial, and recalling them wasn't possible, defense lawyers asked Smith to assess the five-year minimum for Count Three — and let the prosecution argue for longer sentences on appeal.

But the judge reached into the top hat of drug law precedent and pulled out a rabbit. He decided that all of the Davidians had "constructive possession" of automatic weapons, and that access to such weapons constitutes their "use." When a drug merchant stocks his home with a supply of weapons, the judge explained, federal courts regard that home as a "fortress," and the weapons as having as their purpose the furtherance of an illegal activity. Judge Smith argued that, "weapons were an important part of [the] criminal undertaking and their availability increased the likelihood that the criminal undertaking would succeed." By analogy, he said, the Davidians lived in "not only a figurative but a literal fortress," whose purpose — as far as the judge was concerned — was to murder ATF agents.

### Down For The Count

Having brushed aside the jury's findings, having put automatic weapons in the hands of people who had never touched them, and having equated the vegetarian, celibate, non-smoking, clean-living, drug-free Davidians with the kings of cocaine, Judge Smith lowered the boom. He ordered five of the Davidians — Brad

## COUNTERFEIT GUNS

that are inexpensive to own and safe to display in your home. They are realistic, full size working metal models that look, feel, weigh and handle like the expensive originals. You can work the action, release the clip and dry fire these high quality models.

**CANNOT BE FIRED!**



**ISRAELI UZI SUBMACHINE GUN**  
Used by Israeli troops in the historic 6-Day War, the Entebbe Raid. Adopted 30 other nations as the most successful sub-machine gun on the market today.

Over 72 parts folding metal stock detachable 32-round magazine. Length 25" Wt. 9 lbs.

#01-705M.....\$310 PPD

**Exact Replicas in Metal!.....**



**1921 THOMPSON**

as used by FBI & U.S. combat troops. Over 59 parts, including vertical foregrip, detachable wood buttstock & 20-rd. magazine. Lgth. 35". Wt. 9.5 lbs. Disassembles like original.

#01-700 .....\$299 PPD

**Full size (non-firing) models look, weigh, and handle like the originals.**



**M-16 ASSAULT RIFLE**

The ultimate defense arm as used by S.W.A.T. forces. Made famous by U.S. troops in S.E. Asia. Full size. Bolt functions like original—over 70 ABS plastic and metal parts. CANNOT BE FIRED. Lgth. 39". Wt. 5 lbs.

Declared "non-gun" by the Federal Gov't.

#39-2707.....\$300 PPD

**FULLY ASSEMBLED**

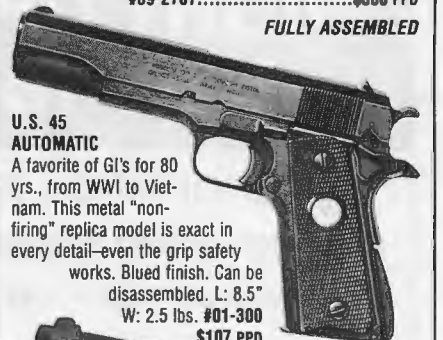

**U.S. 45 AUTOMATIC**

A favorite of GI's for 80 yrs., from WWI to Vietnam. This metal "non-firing" replica model is exact in every detail—even the grip safety works. Blued finish. Can be disassembled. L: 8.5" W: 2.5 lbs. #01-300

\$107 PPD



**M92 AUTOMATIC**

This massive 9mm was chosen to replace the .45 auto. Made famous in Operation Desert Storm, this blued "non-firing" metal model actionworks like the original. Can be partially disassembled. L: 8.5" W: 3 lbs. #22-1254.....\$102 PPD

**COLLECTOR'S ARMOURY**  
800 SLATERS LANE, DEPT. SO  
BOX 59, ALEXANDRIA, VA 22313

Not sold to Calif. except for theatrical use.

SEND: \_\_\_\_\_  SEND FREE CATALOG  
Credit Card Orders: 1-800-544-3456 Ext. 515

NAME \_\_\_\_\_  
ADDRESS \_\_\_\_\_  
CITY/STATE/ZIP \_\_\_\_\_

MONEY BACK (LESS POSTAGE) IF NOT SATISFIED

Branch, Kevin Whitecliff, Jamie Castillo, Livingston Fagan, and Renos Avraam to prison for 10 years, for aiding and abetting involuntary manslaughter — the charge for which the jury had found them guilty. Then he sentenced them to 30 years each for using an automatic weapon in furtherance of the conspiracy in which, the jury said, none of them had participated.

Smith's verdict in regards to Fatta, who had left Mount Carmel hours before the ATF raid, was similarly skewed. The judge sentenced Fatta, who had faced a maximum 10-year sentence for supplying weapons, to a 15-year term instead. Judge Smith explained that it was obvious — if only to him and the prosecutors — that Fatta had been a part of the dubious conspiracy to murder four ATF agents. The jury had found nothing of the kind.

The judge stuck Riddle with only a five-year sentence on the Count Three complication — because she showed remorse, he said. He sentenced Graeme Craddock, whom the jury had found guilty of illegal possession of a hand grenade, to 10 years

on that charge, and to an additional 10 — not 30 years on Count Three, because Craddock had cooperated with federal investigators. Both Riddle and Craddock, it seemed, drew lighter sentences because during their allocutions, they had not spoken defiance to power, as Fagan, Whitecliff and Castillo had.

The jurors who had sat in the Davidian case, and who, because of concern or curiosity, attended the sentencing, reacted immediately — and with shock. Literally in tears on the steps of the courthouse, forewoman Bain perhaps spoke for them all: "The judge just kind of overlooked the jury's verdict," she whimpered. Had Count Three gone back to the jury, she revealed, the jurors would have settled on an acquittal — or would have hung.

The upshot of the sentencing is that eight Davidians will now serve a total of 240 years in prison. Their sentences for manslaughter, supplying and possessing weapons — charges on which the jury found them guilty — total 70 years. And they'll spend an additional 170 years behind bars for the conspiracy of which they

were acquitted. In a word, the crime of which they were innocent — conspiracy — will cost them more time than crimes of which they were guilty. It's an outcome that stands logic — not to speak of justice — on its head.

Even with time off for good behavior, federal prisoners must complete 85% of their sentences; they receive only 51 days of "good time" for every year they spend behind bars. If the Davidians are credited with the time they've already spent in jails awaiting trial and sentencing, without bond — some 14 months — the five who were given 40-year terms won't be out of prison until 2027.

In an exclusive interview with *Soldier Of Fortune* after sentencing, several jailed Davidians told how they regard their fate. "From day one, it was a process to make it look like we were getting a fair trial ... but I think that the judge had his mind made up," Castillo charged. "The system is about authority and control, not about justice," Fagan warned. "In my case, there's nothing that I can do but stand in my faith regardless of what the government does. They can't take my freedom away," he said, "because my

# NIGHT OPERATIONS SPECIALIST Now You Can Own The Night!

## SHOPPING LIST

- a \_\_\_ Night Vision Goggles (NVG)
- b \_\_\_ Aviation NVG - ANVIS
- c \_\_\_ NVG Magnetic Compass HUD
- d \_\_\_ Night Vision Binoculars
- e \_\_\_ Night Weapon Sights
- f \_\_\_ Night Photography Scopes
- g \_\_\_ Laser Weapon Aimers
- h \_\_\_ IR Flashlight Filters
- i \_\_\_ IR Chemical Lights
- j \_\_\_ IR "Fireflies"

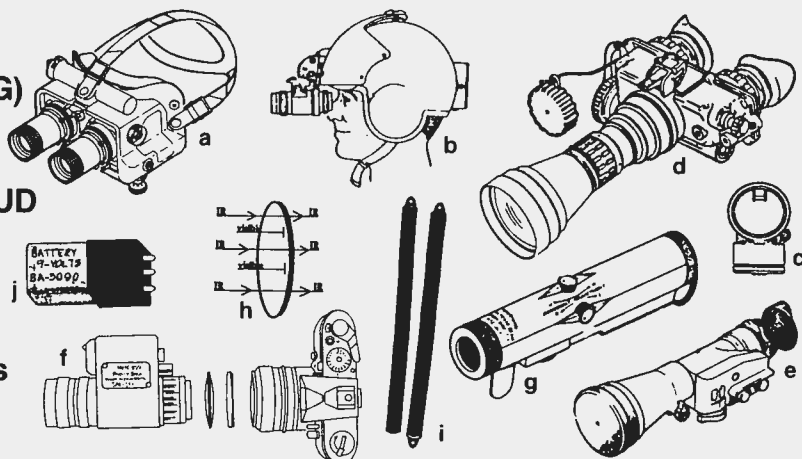

Call for FREE  
Product  
Listing  
or send \$4.00  
for complete  
catalog!

### FFL DEALERS CALL FOR SPECIAL SAVINGS & NEW PRODUCTS!

1. Our night vision systems are manufactured using the finest in NEW components and image intensifier tubes.
2. Our image tubes are MADE IN THE USA by a major manufacturer of night vision systems for the US Military (no Russian surplus).
3. Our systems are WARRANTED for TWO FULL YEARS.

WORLD'S LARGEST STOCKING DISTRIBUTOR OF U.S.-MADE NIGHT VISION EQUIPMENT!

**EXCALIBUR ENTERPRISES, P.O. BOX 400, FOGLESVILLE, PA 18051-0400**  
(610) 391-9106 **Special equipment for NIGHT OPERATIONS** FAX (610) 391-9223

freedom begins with God at the level of the soul."

*Dick J. Reavis is a free-lance writer in Dallas currently writing a book about the ATF/Branch Davidian affair. ✂*

---

## JUMPING DONOVANS

*Continued from page 31*

ras in August.

On hearing the news, Trial posed a question to the elder Donovan on the delicate matter of door positioning: "So, John, are they going to sandwich you?"

"Hell, no," Donovan retorted. "I'm in the door and they follow me."

*Those interested in jumping with the Phoenix Group can contact Clint Trial, 3036 Lake Lansing Road, Suite 150, East Lansing, MI 48823; phone: 517-351-3113, or fax: 517-351-5713. They also sponsor, through legitimate government approval, training in military-type courses (Static-Line HALO/HAHO, Ranger, Jungle Survival, etc.) for active-reserves who petition for*

*equivalent training at alternate sites, and for individuals who were unable to receive the training, for whatever reason. The school is not geared for mercenary-types, but for people who want a challenge without the long-term commitment to military service. ✂*

---

## CLEAR & PRESENT DANGER

*Continued from page 48*

Clancy's former-SEAL-now-CIA contract man, Mr. Clark. Rounding out the team was Jamie Gomez as the sniper-observer Osso.

Chandler and Goyen started the team off with a visit from a genuine covert operator just returning to the United States. "The actors really seemed to pull the attitude out of the guy. If he impressed them with anything, I think it was the attitude of 'the mission first but your people always,'" Chandler observed.

Weapons training was probably the most critical skill in which the actors

had to be brought up to speed. For this, Chandler and Goyen took their team to a private tactical training facility and started working them on handguns and machine guns, and eventually sniper weapons.

Because first-rate sniper skills were an important part of the script, Chandler signed Cruz up for a week at Camp Pendleton's Marine Sniper School. Under Chandler's tutelage it was only a few days before Cruz was moving through a combat qualification course with confidence.

With filming almost upon them, Chandler and Goyen needed to turn the actors' minds to the more stealthy pursuits of the SpecOps game, to really get the civvies to experience the isolation and exhaustion that insertion teams deal with matter-of-factly.

Chandler and his bevy of actors shipped out to Los Cascatos, Mexico, where most of the jungle action was scheduled to be shot: The Chiapas province revolt started just days before they arrived. Weapons for training in Mexico were limited to non-firing replicas until actual shooting of the film. Los Cascatos was a perfect place to teach simulated co-

# PENETRATING



DESIGNED BY CUSTOM KNIFE MAKER MR. PHIL BOGUSZEWSKI, THE SPIKE IS ONE OF OUR MOST POPULAR KNIVES IN THE CUSTOM DESIGNER SERIES. LONG ONE OF OUR FAVORITES, THIS MODERN CLASSIC URBAN FOLDER FEATURES A RAZOR SHARP BLADE, SYMMETRICALLY TAPERED HANDLE AND OUR SMOOTH-AS-SILK LOCKING MECHANISM.

MADE IN  
**USA**

**BENCHMADE**

SEND \$2.00 (SHIPPING AND HANDLING)  
FOR YOUR FREE BENCHMADE BROCHURE TO:  
BENCHMADE KNIFE COMPANY INC.  
15875-G S.E. 114TH STREET  
DEPT. S-F  
CLACKAMAS, OREGON 97015 U.S.A.  
OR CALL 503-655-6004



# K.A.O.S. KUTLERY



**"Knives Are Our Stuff"**

SEE US AT  
TABLE #1151  
AT THE EXPO  
AND GIVE US  
A "HEY, HOWDY, HI"

FOR MORE INFORMATION

**BOX 88 NOXON, MT. 59853**

vert jungle operations, being relatively remote and overgrown with lush vegetation. For the next two weeks the team was to "eat the local's goat meat, drink their iguana milk, worship their stone gods," laughed Chandler.

The first day of training in Mexico proved to be more than the actors had bargained for when Chandler led his team to an 800-foot cliff and shouted, "Let's go!" Unnerved, some of them wanted to know where they'd be stashing their LBEs. Chandler just pointed at his back and nonchalantly let go with his rappelling rope over the side. All of the men were in good physical shape and soon began to get into the spirit of things. Gomez was especially enthusiastic. Chandler said, "He was just loving the shit out of it!"

After five days of night patrols and silent scouting they started to function as a team, to feel they were portraying soldiers who operate in this different world. One day Chandler observed Bratt and noticed the look in his eye — he had *become* his character, Capt. Ramirez. The long days of stealth and stalking were paying off — even if Bratt did refuse to eat MREs, opting for his own trail mix and dried apricots.

"They got so good at concealing themselves that they couldn't be compromised from 2 feet off the trail by the occasional tourist who roamed the area," said a more-than-proud Chandler. Cruz began to realize that if he had to, he really could cap a guy with his M24. Chandler even led them on a little unauthorized raid one night, infiltrating a local Mexican power plant completely undetected.

Five days in, Dafoe showed up straight from another acting gig. It was decided that he should be rear security, acting as "Tail End Charlie" on patrol. He wanted a sense of feeling alone to complete his characterization of the CIA loner, Mr. Clark. Soon Dafoe, too, felt he owned the night.

Cruz came the closest to a real encounter while walking point on a recon. As he came out of the overgrowth in his cammies and face paint with his M16 raised high, three local *campesinos* looked up startled, raising their machetes. Cruz calmed them in Spanish, "It's OK, we're training for a movie." The three machete-wielding farmers just shook their

## Popular Magazines of the World

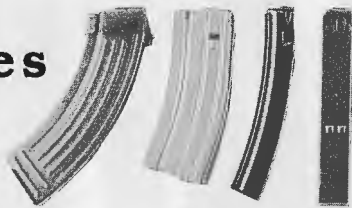

AK47 M16 MP5 UZI Machine Gun News



**Machine Gun News** — the indispensable magazine that contains information not found in other firearms publications. **Machine Gun News** keeps you informed about the status of federal firearms laws, rulings and bans, and the effect these laws will have on ownership. Plus, every issue features

an arsenal of information including in-depth articles and reports on machine guns, suppressors, and semi-autos. Whether it's differences in parts, sources for magazines, or functioning problems **Machine Gun News** brings you solutions. It is a unique firearms magazine that never runs out of ammo.

### Special 7th Year Anniversary Offer

The regular yearly subscription price is \$34.95. But, for a limited time, you can have a full year's subscription (12 issues) for only \$29.95. Complete the coupon below or call 501-525-7514 and subscribe now!

**Yes!** Start my subscription to Machine Gun News. I'll receive 12 information-packed issues for just \$29.95! (Offer good in U.S.A. only. Foreign subscribers send for rates.)

M/C, Visa, AmEx #

\_\_\_\_\_ Exp. \_\_\_\_\_

Check/Money order enclosed

To ensure your privacy **Machine Gun News** is mailed with a protective cover.

Watch for your first issue in 4-6 weeks!

name \_\_\_\_\_

address \_\_\_\_\_

city \_\_\_\_\_ state \_\_\_\_\_ zip \_\_\_\_\_

Send to: Machine Gun News  
P.O. Box 759, Dept SFP,  
Hot Springs, AR 71902

Or call: (501) 525-7514

Fax order line: FAX5015257519



heads in disbelief, even though locals had been notified such things would be taking place in the area.

*Clear and Present Danger* is about political treachery and tragedy, with the grunts the ones who ultimately pay the price. And if it has a strag, realistic look to it, it's in no small part due to the efforts of two dedicated SpecOps troopers.

*As close to an official Hollywood correspondent as SOF gets, Dan Gagliasso is a former bull rider and current screenwriter with three produced films to date.* ✕

## GARDENING AT NIGHT

*Continued from page 67*

but claim you sold it at a big gun show as a private sale and don't remember the buyer's name. This could be embarrassing if they discover the sold item buried under your front porch, however. It would also be very embarrassing if someone accidentally discovers one of your caches and they trace the guns back to you. You could deny knowledge, but things could go badly for you if you left fingerprints on the guns and inside the "time capsule." Remove all possible clues as to your identity, or risk exposure.

Sixth, make multiple layers of protection for the items to be stashed. Water is your biggest enemy. It can seep in slowly over a period of years and cause the same damage as if you had simply buried the items unprotected in your back yard. Don't forget to consider the effect of the changing seasons, either. The freezing and thawing of several winters can damage a poorly chosen "time capsule," making the contents vulnerable to the elements.

When making the actual capsules, it is important to have a rugged, waterproof container. Many have opted for the use of plastic irrigation pipe. Cut to five-foot lengths and fitted with plastic end caps, they make very serviceable storage containers. Others prefer surplus waterproof military containers. Plastic is generally preferred over metal as it is lighter, cheaper, rustproof and can't be picked up by metal detectors — although the same is not true of the container's

# It's time to call in the heavy hitters!

Forget those "magic" bullets that turn into pretty stars or grow claws. Cor-Bon® offers street-proven performance, harder-hitting, higher velocities, and low muzzle flash that won't make you the target... all in the heavier bullet weights that the pros prefer: 230 gr. / .45, 180 gr. / .40, 158 gr. / .38, 147 gr. / 9mm and more. Cor-Bon ammo isn't fancy. It just plain gets the job done!



**TO ORDER: 1 800 788-2666**

## Using G-Jo - First-Aid of the Samurai - You FEAR NO PAIN OR INJURY!

It's true! As a Master of G-Jo Acupressure, you can "erase" pain (and most other common ailments) in seconds ... using nothing but the touch of your finger! G-Jo is based on a network of secret pressure points (many of them used in the martial arts). When an injury occurs, reach for the right G-Jo point ... "trigger" it in the special way...and sigh in relief! Be up and ready for action in moments -- or help your loved ones, friends or students -- using this remarkable technique. G-Jo is so foolproof it works for skeptics as well as "believers." G-Jo even halts serious bleeding. This life-saving skill is *vital* for those in the martial arts... the healing arts... survivalists and outdoorsmen -- or anyone who ever finds himself far from doctors, medical help or hospitals.

G-Jo is safe for all ages... natural... effective in healing hundreds of injuries and ailments ... and it works instantly! Not only for treating serious injuries, G-Jo relieves headaches... backpain... indigestion, and other common ailments in seconds. Proven to millions on major talk shows. So effective, G-Jo can even become your total health-care program! Yet this age-old technique is so easy, you can actually become a certified *Master of G-Jo Acupressure* in as little as one weekend of study! We offer the only home-study acupressure certification program available. Send for your **FREE** report today. The G-Jo Institute, Dept 111, Box 8060, Hollywood, FL 33084 "Teaching G-Jo Acupressure Since 1976"



## SWITCHBLADE - AUTOMATIC KNIFE COLLECTORS

### The Automatic Knife Resource Guide and Newsletter

A unique publication for the automatic knife enthusiast, NOW in it's **THIRD YEAR!** Terrific photos, in-depth articles, maintenance and repair tips, the **LATEST** trends, resources for ALL kinds of automatic knives, free classified ads and **MORE!** Send \$10. for single issue or \$30. (\$36. Foreign) for one year [4 issues] subscription to: "THE NEWSLETTER" 2269 Chestnut Street, Suite 212-A, San Francisco CA 94123, USA, Phone/FAX: 415 731-0210.

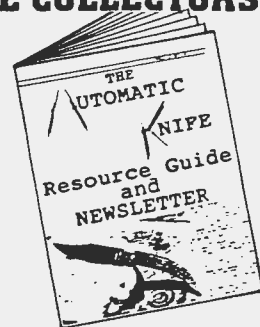

YOU can be a part of it

# The American Association of Intelligence and International Security

OPEN TO GENERAL PUBLIC MEMBERSHIP AS WELL AS  
FOR THE PROFESSIONAL INTELLIGENCE COMMUNITY.

*Members learned what to expect from N. Korea a long time ago. Members offered top professional investigation training at deep discount. Members are always way out front in every area. You can be a part of it, too.*

Members also receive a special personalized, official A.A.I.S. membership card, newsletters, special reports, special product offers and the opportunity for interesting personal involvement.

Send \$28. check, for a 1 year membership, made out to our processing agent:

AMERICAN COMMUNICATION ARTS (DEPT. SF-B)  
1742 GARNET AVENUE - #144  
SAN DIEGO, CA 92109

metallic contents. Paragon Sales stocks a plastic tube with excellent potential as a storage container. Originally designed to provide long-term storage for artillery charges, it has a screw-off lid and a waterproof rubber sealing gasket. Available for \$29.95 plus \$5 shipping in the Lower 48, I believe they are the best way to go. I recommend them highly if you plan to take up "gardening at night" as a hobby.

### Protect The Contents

Once you have obtained the basic "capsules," carefully prepare the contents. Recent-manufacture military surplus ammunition is the best choice, particularly if stored in sealed "sardine" cans. If sealed cans are not available, you should seal the ammunition in GI ammo cans that are in good condition. Make certain the cans have good rubber gaskets that seal properly. Be generous in the use of packages of desiccant both in the ammo cans and in the cache tubes themselves. Don't *open* the desiccant packages, just toss them in among the items to be stored. When exposed to air, desiccant packages absorb moisture. *If you think that your desiccant packages are used up, you can "re-charge" them by heating at low heat in your oven.* Be careful that your desiccant doesn't come into direct contact with metallic surfaces as it will cause oxidation, better known as rust, in those areas in direct contact. Several layers of crumpled paper (do not use newsprint, as its residual sulfur causes rust) are sufficient separation. Don't put your desiccant by itself in a sealed plastic bag because the inside of the bag will be dry while the burial container could be soaking wet. The desiccant will only dry the air that circulates around it. If you have several layers of airtight protection, you need several sets of desiccant.

Unless your firearm is brand new and still carries the factory grease, you should clean it carefully before putting it into long-term storage. The weapon should be given a heavy coating of clean grease both inside and out. The military uses a special grease called *Cosmoline* for the long-term storage of firearms. You can sometimes find it for sale at gun shows. You might substitute a good quality, water-resistant, automotive or marine grease. Wrap the greased weapon carefully in heavy wax paper and then in a sturdy plastic

# Your Survival Close at Hand!

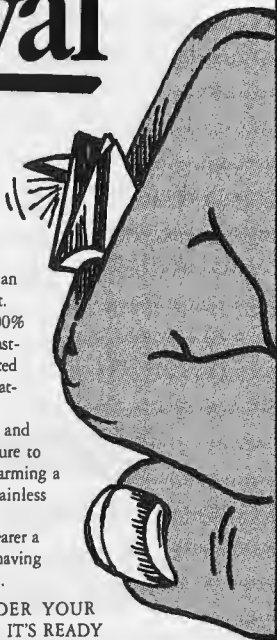

The PROTEK RING is a new and unique piece of jewelry that automatically transforms into an effective personal self defense unit.

The PROTEK RING is 100% waterproof, dependable, long lasting and durable, meticulously handcrafted in classic sterling silver or vermeil (gold plated) to your ring size.

The PROTEK RING is reliable and easy to use by simply applying pressure to the spring loaded top, automatically arming a hidden, retractable, 1/4" surgical stainless steel blade.

The PROTEK RING gives the wearer a great advantage in case of attack by having the element of surprise on his or her side.

FOR YOUR SELF DEFENSE ORDER YOUR PROTEK RING TODAY. REMEMBER IT'S READY WHEN YOU'RE NOT.



**Only \$79.95**  
shipping & handling \$4.95

Only available from The Goldminer. Satisfaction Guaranteed.  
For defensive purposes only.

By ordering, you acknowledge that you are an adult and there are no legal restrictions.

#### ORDERING INFORMATION

Send cheque or money order to:

**The Goldminer**

P.O. Box 89041, 991 King St. West,  
Hamilton, Ontario. L8S 4R5

VISA & MASTERCARD ORDERS call

**1-800-387-0523**

material, such as a heavy-duty trash bag.

Accessories such as magazines should be stored in the same container as the weapon and similarly prepared. Do not load the magazines as this stresses the springs and may ruin their usefulness. Be sure to include cleaning gear, magazine pouches, stripper clips if pertinent and loading tools if necessary. A real pessimist might even include a set of lightweight camouflage. There are efforts to ban "military" clothing and you might find such items unavailable if things get so unpleasant that you feel compelled to dig your cache up to play Minuteman and fight off the oppressive Redcoats.

Don't try putting a bunch of gee whiz toys into long-term storage. They probably won't be nearly as useful as a few spare parts or an extra pistol. Pistols have a definite place in a cache as they are easily concealable and thus very handy in hard times. Having a .50 is fine but it doesn't lend itself to discreet transport or use. Be practical. After all, you are building this emergency stash *just in case*.

As I said earlier, scatter your caches but do so wisely. Don't plant them so close to you that you are suspect if

one or more is uncovered. Likewise, separate them enough so that if one is discovered, searchers won't discover the whole hoard. Put them *miles apart* if at all possible. Plant them close enough that they are reasonably accessible. A cache in Montana is of little value if you live in Alabama. You might consider putting one of your caches in a far-off location if you visit that area occasionally. It would be useful if you were caught away from home or could not approach your normal caches for some reason.

Those in urban areas might be forced to consider hiding caches nearby or in hidden compartments. Paladin Press offers an interesting book called *Modern Weapons Caching* by Ragnar Benson, which offers the reader some clever ideas on this subject. A rifle could be concealed in a fake ceiling beam while a large flower bed could be the resting place for a sizable container of forbidden goodies.

If you feel the need to put something into long-term storage, I urge you to obey the law as to what you do. Be careful out there, people.

*Dutch Hillenburg is an importer of*

*night-vision equipment and editor of "The Ammo Bunker" column in Machine Gun News, from which this article is reprinted. ✕*

## CHARGIN' CHARLIE

*Continued from page 65*

ation until it was almost too late. With the energy and will for which he was famous, and much to the amazement of British doctors, he managed to beat the odds and recover.

He took a solid hit from a 12.7mm round over Bong Son, Vietnam, in early '66. As old hands tell it, doctors performing triage decided he was not going to make it and were planning to administer last rites. He regained consciousness during this debate and was said to have climbed up off the stretcher. Holding a couple of feet of intestines in his hands, he told them if they did not fix him up he was going to kick their collective asses as his last official act on earth. With that gentle admonishment to motivate them, the doctors finally managed to

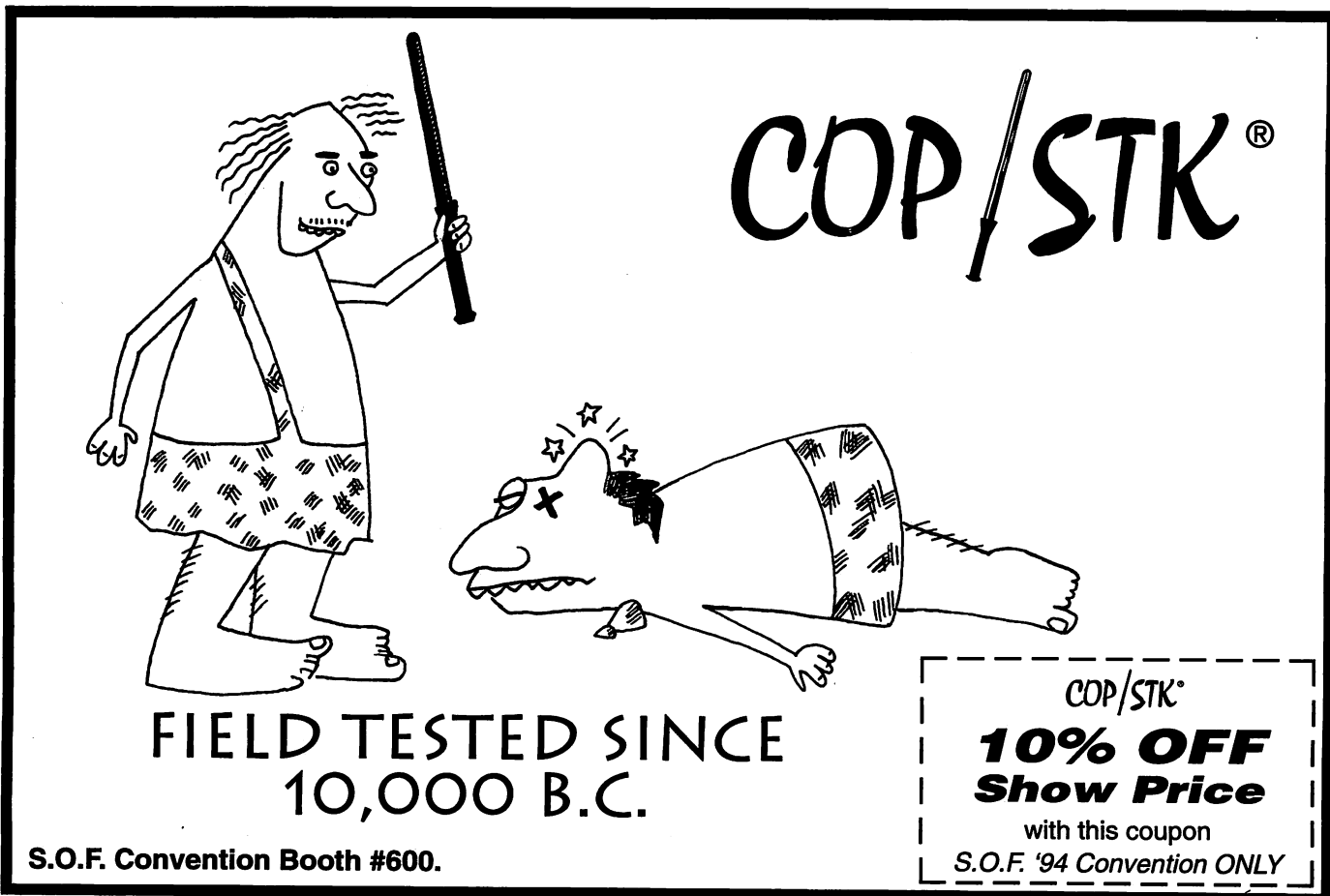

**COP/STK<sup>®</sup>**

FIELD TESTED SINCE  
10,000 B.C.

S.O.F. Convention Booth #600.

COP/STK<sup>®</sup>  
**10% OFF**  
**Show Price**  
with this coupon  
S.O.F. '94 Convention ONLY

## WHERE TRAINING COUNTS



Today's law enforcement and military personnel need the finest training available. **Gunsite Training Center** offers all levels of specialized programs for qualified clients.

*Our professional instructors train special military, counter terrorist, SWAT and others in pistol, rifle, shotgun and special weapons.*

### Let us train YOU!

Call or write for our free catalog and complete training course descriptions to:

Dept. SOF, P.O. Box 700  
Paulden, AZ 86334

602-636-4565, FAX 602-636-1236



## BELTBAG HOLSTER



U.S. MADE

Carry concealed with this low profile **BELTBAG HOLSTER.**

You can carry MACE, STUN GUNS, or a PISTOL in the false back. Simply rip open the hook & loop and snap closure for quick access to the contents. The **BELTBAG HOLSTER** is made from black leather or 1000 Denier CORDURA Nylon in 4 sizes. The Nylon bag is available in solid blue or solid black, or two tone using one of 4 trim colors (grey, maroon, turquoise or blue). Left hand or long belt available on request at no extra charge.

- Style #1- fits small 22, 25 autos up to AMT back up  
Nylon...\$15.<sup>00</sup> Leather...\$35.<sup>00</sup>
  - Style #2- fits 2" S&W J-frame, Walther PPKS, Colt Gov't 380  
Nylon...\$20.<sup>00</sup> Leather...\$45.<sup>00</sup>
  - Style #3- fits Colt OM, Glock 19, S&W 6900, B91.3, 2" S&W K-frame  
Nylon...\$25.<sup>00</sup> Leather...\$55.<sup>00</sup>
  - Style #4- fits Colt 1911, Browning HP, Beretta 92, 3" Revolver, most large autos  
Nylon...\$30.<sup>00</sup> Leather...\$65.<sup>00</sup>
- (\*\$3.<sup>00</sup> S&H) Call or write for FREE catalog

### KG Products

1740W Churchill Dr.  
Oakland, OR 97462



**1-800-944-7717**

put him back together — minus a number of major components.

After he was released from the hospital, he took over the old Florida Ranger Camp at Auxiliary Field 7, where I joined him after an extended tour in the Highlands. As before, with Charlie as our ring-leader and dubious role model, it was fun from start to finish. Major Beckwith nurtured a sense of camaraderie among junior officers which I have not experienced before or since.

His change of command ended with a blitzed Ranger cadre destroying Eglin Air Force Base Beach Club and a place in town called the Continental Club. After wreaking general mayhem and terrorizing all the locals, I figured anyone wearing a black beret was in big trouble. Not so. That, of course, was before political correctness, back when the military services still had a sense of humor.

Over the weekend we had taken up a collection to repair all the damage, and Charlie had hammered all the wronged and aggrieved parties on the back, overwhelming them with his imposing personality. Miraculously, he had managed to win back their good graces, complete with letters playing down the entire affair.

We then watched in awe as he blustered into the general's office and simply took over. He sat down in the man's chair, fished the police report out of his in-box, hustled his secretary out for coffee, and read us the choicer parts of the report while snorting and laughing uproariously. What Charlie often did was so outlandish it caught people totally off-guard, and once they were off balance, he would then bowl them over by sheer force of personality.

When the general showed up, Charlie was sitting in his chair drinking coffee from his cup. Charlie immediately jumped up, vociferously greeted the stunned general, pumped his arm enthusiastically and congratulated him on the fact he was wearing jump wings. Charlie made vague references to the delinquency report — which looked like the initial draft for *War and Peace* — all the while assuring him everything was taken care of, everyone was happy, and all was well on Eglin Air Force Base.

Charlie wanted to set up an exchange program between U.S. Rangers and French Commandos similar

## ADVERTISERS INDEX

Adco .....	Cover 4
American Assoc. of Intelligence .....	82
American Survival Films .....	77
Automatic Knife Resource Guide .....	81
B-Square .....	85
Benchmade Knife Company .....	79
Berett Industries .....	77
Blaylock's Gun Works .....	68
Bushmaster .....	28
C.H. Worldwide .....	70
Collector's Armoury .....	77
Cop Stik .....	83
Cor-Bon Bullet Company .....	81
Crown Specialty .....	74
Delta Press .....	70
Doubleday Military Book Club .....	9
The Edge Company .....	13
Excalibur Enterprises .....	78
Executive Protection .....	11
Facets Advertising .....	30
Fighting Firearms .....	85
G-Jo Institute .....	81
The Goldminer International .....	82
Gunsite Training Center .....	84
Handstraps .....	71
Intelligence Incorporated .....	Cover 2
Israeli Sky Connection .....	92
K.A.O.S. Cutlery .....	80
KG Products .....	84
Lifefinder .....	86
Machine Gun News .....	80
Michaels of Oregon .....	76
Michigan Body Armor .....	71
Moore Technical Industries .....	87
National ID Center .....	72
Olympic Arms .....	73
Optimum Training Systems .....	21-24
Orpheus .....	85
Paladin Press .....	7, 26, 27
Quality Machining Inc. .....	72
SCM Corporation .....	76
S & K Products .....	30
S.T.A.N.O. .....	75
Shooting Systems Group .....	73
Silver Creek Industries .....	71
SOF Sweepstakes .....	18, 19
Sonic Technology .....	69
Southern Ordnance .....	12
Steve Arnold's Gunroom .....	14
U.S. General Technology .....	Cover 3
Universal Force Dynamics .....	71

### SUPPLY LOCKER

Carl Ax .....	90
Cutting Edge Enterprise .....	88
David Steele Ent Inc. .....	91
Delta Arms .....	88
Eden Press .....	91
Global School Of Investigation .....	88
Gun Parts Corporation .....	90
Hitek .....	90
Hurricane International .....	90
JTR Labs .....	90
James W Black .....	91
LA Law Enforcers .....	89
Lile Handmade Knives .....	91
M.O.R.O. International .....	88
Matthews Police Supply .....	90
Miniature Machine Corp. .....	90
National ID Center .....	88, 91
Politically Incorrect Graphics .....	89
Professional Career Development .....	89
S & K Products .....	88
SOF California Reader .....	91
Spec Ops Catalog .....	91
Trade Partners Group .....	89
U.S. Cavalry .....	89
USI Corporation .....	89
Westbury Sales Co. .....	88
WW2 Products .....	89

ADVERTISING POLICY: Publication of any advertisement in Soldier Of Fortune Magazine is not an endorsement of the advertiser of the product(s) or service(s) advertised, either by SOF Magazine or by the Editor and Publisher.

to what we had between Special Forces and the SAS. He sent me off to French parachute and commando schools. Unfortunately, it was dropped after the first exchange because French officers refused to submit to U.S. Army-style harassment.

By the time I got back from that ordeal, Charlie was at Fort Campbell preparing to ship out to Vietnam with the 101st. With him gone, everything seemed dull. I followed his example and volunteered for another tour but ended up in a different division, in a different area. We never soldiered together after that, but kept bumping into each other. By the time I finally returned to the Special Operations community in the early '80s, Charlie had retired from the Army to found his own security firm in Austin, Texas. His legacy lingered on, and I could still see evidence everywhere of the Beckwith stamp and style.

Although anecdotes about this unforgettable individual will be passed around clubs and campfires for many years, I am certain Col. Beckwith would want to be remembered as a man who had a dream, a visionary military thinker whose tenacity and perseverance led to the establishment of an organization created in his own image. His friends, the Army and America should always remember him as the founder of the U.S. Army's most elite fighting unit — the famed Delta Force. No one else could have done it; no one else had the requisite charisma; no one else would have stayed the course.

The idea that was formed in the jungles of Malaya, but had fallen on deaf ears for so long, was finally realized only through the determined perseverance of its author. Through his herculean efforts, he left an enduring legacy which has greatly benefited America, and which is certain to be of even greater utility in the increasingly troubled and destabilized world of the future.

Colonel Beckwith's passing has saddened all who knew him, but those of us who were with him during the early years are, no doubt, especially shaken. He was our first real hero, a paladin in the old-Army image. We all supposed Charlie Beckwith was invincible, so to us, his premature departure at the age of 65 is indeed a sobering blow. I am somewhat consoled in the knowledge that Valhalla

# Bipods

## The Ultimate

### Options:

#### Model Flexibility -

- "Roto-Tilt" - Pans & pivots omnidirectionally
- "Tilt" - Legs pivot on uneven ground
- "Rigid" - Solid, fixed leg

#### Finish -

- Blue
- Stainless

#### Attachment -

- "Sporter" Swivel Stud
- "Service" Barrel Clamp



## FEATURES

 All Models Mount Forward	 All Models Mount Rearward
 No Gunsmithing Quick Attach/Detach (All Models)	 Unlimited Leg Extensions (All Models)
 Pivots (Tilt & Roto-Tilt Models)	 Pans (Roto-Tilt Model)

# B SQUARE

Ask Your Dealer or Call  
**1-800-433-2909**

# FIGHTING FIREARMS

Published twice a year by Omega Group Ltd., **Fighting Firearms** covers the latest developments in **small-arms technology** and **firearms employment tactics**. Edited by **Soldier Of Fortune's** Technical Editor **Peter G. Kokalis**.

Targeted at the **hunting, law enforcement** and **military** markets, **Fighting Firearms** is the only forum for new, in-depth, up-to-date information for the growing number of paramilitary firearms users and enthusiasts.

For back issue and subscription information call: 1-800-800-7630

**ISSUE #3  
FALL '94  
ON SALE NOW!**

"INCREDIBLE" Guns Magazine "ABSOLUTELY AMAZING" Guns & Ammo "BEST LEGAL FULL AUTO" Soldier of Fortune

10/22 • TEC 9 • 22 • SP 68 • M1 GARAND • MAC 11/19 • AP9

## UNLEASH "HELL-FIRE"

Do you own any Semi-Automatic and want to Rock 'N Roll! Well, the all-new "HELL-FIRE" Trigger System is here! You won't find anything closer to a "Select Fire" Conversion, **and it's LEGAL!** The unit is installed externally in seconds. It does not interfere with the normal operation of trigger. When engaged, you may fire bursts, to emptying complete magazines at a **full automatic rate accurately and legally!** Hurry and get yours now before it's too late! Minimum age to order - 18 years.

MODEL HFS (UNIVERSAL) FOR MOST SEMI-AUTOMATICS <b>\$2995</b> COMPLETE PREPAID	MODEL HFS 22 FOR 10/22 FOR MOST SEMI-AUTOMATICS <b>\$1995</b> COMPLETE PREPAID
---	--

**PHONE ORDERS ONLY (303) 249-2694**  
OR SEND CASHIER'S CHECK OR MONEY ORDER TO:  
(PERSONAL CHECKS DELAY ORDER)  
**HELL-FIRE SYSTEMS INC.**  
P.O. BOX 549, OLATHE, CO 81425

U.S. Pat. & Other Patents Pend. Colorado residents add 4%  
Visa/MC

"THE BEST" American Survival Guide LIFETIME WARRANTY

AR15 • MINI 14,30 • M1A • 30 CARBINE • AKS • DAEWOO • FNC • HK 91, 93, 94 • AT 9 • CAMP 9, 45 • SKS • FAL

is probably a more interesting place with him on board, as he is certain to keep things in a general uproar. Henceforth, whenever I hear the soft rumble of thunder in the gathering twilight, I will simply attribute it to the gods groaning over the most recent escapade of Col. "Chargin' Charlie" Beckwith: a great soldier, a good man and an old friend.

*In addition to extensive service in Vietnam, Col. Millard "Mike" Peck resigned in protest as Chief of the Special Office for POW/MIA; see "Puppet Masters," SOF August '91. ✕*

## PARTING SHOT

*Continued from page 98*

our eyes and ears, presented every day with news of our unarmed neighbors falling prey in their homes, on our streets, in our places of work and play?

Will we bow our heads to cowards and fools who will not learn and do not understand the lessons of human history? Or will we stand straight and assume the daily tasks and risks that

liberty entails?

Will we ignore even the lessons of this present era — which has seen the cruel oppression of millions on the continents of Europe, Asia, Africa and South America — and believe that the continent of North America is immune to such political disease? Or will we wisely accept the realities of this world, wisely listen to and make use of the precautions provided by our ancestors?

Will we be deceived by shameless liars who say that disarmament equals safety, helplessness equals strength, patriotism equals criminality? Or will we mark the words of our forefathers, who wrote in plain language: *The right of the people to keep and bear arms shall not be infringed?*

Let us make known: We will choose the latter option in every case.

**Legislators:** Do your duty to your country. Uphold the Constitution as you swore to do. Do not shame yourselves by knocking loose the mighty keystone of this great republic — the right to bear arms.

**Justices:** Do your duty to your country. Examine the origins of our right to weaponry and uphold the letter and spirit of the Constitution.

**Lawmen:** Do your duty to your country. Do not be misguided and

misused. Your task is to serve and to protect — not to oppress, to disarm and to make helpless your countrymen.

To the blind, the ignorant, the pathetic, the safe and sheltered, these may seem to be concerns of another age. They are not. They are as vital as they ever have been through history. For times may change but human nature does not. And it is to protect forever against the evil in human nature that the Founding Fathers set aside certain rights as inviolable. For these reasons we must now make known: We will not passively take the path that leads to tyranny. We will not go down that road. **We will not disarm.**

*Readers are encouraged to reproduce this declaration and distribute them to lawmakers at all levels of government. ✕*

## THEY CAN SHOOT YOU

*Continued from page 45*

the rest of the night, if we did not get too trigger-happy.

**New  
And  
Unique!**

Hear Every Syllable!  
They Never "Cut Off!"  
Binaural to Know  
Direction and Range!  
(Forget Stereo)  
High Amplification!  
Up to 40dB!

Input Plug for Police  
Radio And/Or Life Finder!  
Includes NICAD Batteries  
& Charger!

Binar 20/40



Suggested Retail: \$169.95

For Your Free  
Catalog, Contact:  
Life Finder, Inc.  
1311 North Memorial  
Parkway Suite 100  
Huntsville, Alabama  
35801-5903

# ||||| LIFE FINDER ||||| CAN FIND IT!

Another Piece of Equipment  
No Officer Should Be Without!

Suggested Retail:  
LFL-IR2™ \$499.95



**Has Found:**

People Through Smoke      Suspects Hiding in Woods  
Hidden Fires                  Body Parts at Wreck Site  
Buried People (15' Deep)      Hot Cars in Car Lots

**Works From:**

Helicopters                      Ultralights  
Moving Vehicles              Hand Held on Ground

Tested By U.S. Military at Over 3000 Feet  
in Open Area, and Through 300 Feet of Woods.

**New  
Technology  
Delivers!**

New Target Systems  
For Portable or  
Permanent Installations!  
Now Everyone Can  
Have A Range!  
Quick Setup (30 Min.)  
Electronics in Rain  
Tight Box!

Bullet Proof Shield on Top!  
Pop-Up, Turning,  
Swing Arm, & Running!

Target Systems

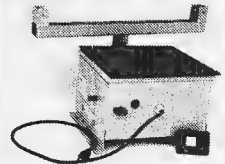

Call for Pricing

Or Contact By:  
Phone: (205) 533-5004  
Fax: (205) 536-3663

Orders Only:  
(800) 459-FIND

The troops set up a 50%-on/50%-off ambush along the highway, anchored by the 1919A6s, while the command group took up residence in the village chief's longhouse, with the point and flank elements of the previous day as security. I made sure my prisoner was being treated decently, which he was, then rolled up to catch a quick nap before my turn on watch. When I awoke the sun was up. The security elements had not awakened anyone in the command group during the night, probably by order of Capt. Khue, who still retained his French attitude toward rank.

Khue, Nay Tay, the VC prisoner, Toon and I shared my chunk of C4 to make up some C-Rat coffee. After our ritual morning jump-start we tried to radio Phu Tuc once again, but were picked up by the MACV Team in Cheo Reo, which was monitoring our net.

### HQ Not Amused

Bad luck. Obviously they did not buy the tiger hunt bullshit, and instead of chuckling and quietly congratulating us for our initiative, they appeared determined to make a big deal of the whole thing. Khue was quick to "advise" me that it was my

own goddamn fault for crowing to them. Oh well, what the hell. At that point we knew the incident would be reported through official channels, which dulled the edge of our good spirits.

Of course we did not share this with the troops, who were still on a high from the success of the mission. Since I was uncertain what lay in store on our return, we shut down the radio, then took our own sweet time getting back to camp, diddly-bopping down the center of Route 7 like it was a victory parade (albeit with a heavy point and with flank security out on both sides of the road keeping up with the lead elements).

As anyone who carried a rifle in Vietnam can tell you, getting a medal for valor is not unlike getting the Purple Heart. Usually you are awarded the Purple Heart for simply being at an accidental point in space and time, where, without doing anything necessarily "right" or "wrong," you get in the way of a high-speed projectile. The same is generally true for all medals: When deserved, they are usually awarded for things that happen accidentally, and, like the tree falling in the forest, someone has to be

there as a witness for it to "really happen." In the conventional units, there were always numerous people to witness events, heroic or otherwise, but in Special Forces during the early days of the Vietnam War, we were very much alone and on our own.

It was difficult to receive any of the really high-powered awards while serving with the 5th SFG, no matter how many Dinks you killed with your bare hands and a broken bottle. In this instance there had been so many VC breaches of the truce, HQ decided it would be poor form to make punitive examples out of Toon and I, so gave us medals instead — Army Commendation Medals with "V" device — citing actions that took place on 27 December 1965.

During my three combat tours in Vietnam, Christmas Eve of 1965 was one of the few times I really felt deserving of any sort of recognition. It was one of the few times that I actually planned and executed a semi-clever operation — rather than simply shooting my way out of a mess I had stumbled into, like a trapped rat.

*Retired Col. Millard "Mike" Peck is a 26-year Army veteran whose career included three tours in Vietnam.*

# BUILD YOUR OWN FIGHTING SHOTGUN!

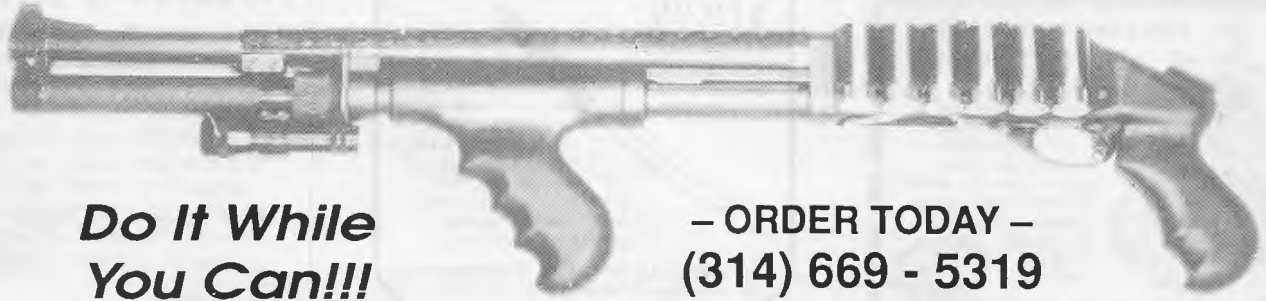

**Do It While  
You Can!!!**

**— ORDER TODAY —  
(314) 669 - 5319**

- Tactical Grips - (front).....\$18.00
- (rear).....\$15.00
- Models to fit Mossberg 500 - 600; Remington 870  
Winchester 1200 - 1300. Specify shotgun & front or rear.
- Magazine Extensions .....\$29.95
- 7 shot for Remington 870, 1100, 11-87 - 8 shot for same  
guns - 7 shot for Winchester 1200, 1300. All for 12 ga.
- Shell Follower, High Visibility .....\$5.95
- Barrel/Magazine Clamps ..... \$5.95
- 2 different models fit all above guns. Specify shotgun.
- QD Swivel - fits above clamps .....\$4.95
- Universal Barrel Shroud .....\$15.95
- 13 3/4 in. long. Fits most 12 ga shotguns without vent rib.
- SideSaddle® Shotshell Carrier .....\$24.95
- Models to fit Remington 870, 1100, 11-87; Mossberg 500,  
600; Winchester 1200, 1300; HK Super 90. Specify gun.
- Tactical Sling .....\$16.95
- 1" Plain Carrying Sling.....\$2.95

- Jumbo Head Safety .....\$8.00
- Fits Remington 870, 1100, 11-87.
- T-45 Tactical Flashlight.....\$29.95
- (includes batteries and nylon carrying pouch)
- Universal Barrel Mount #3 .....\$19.95
- Mounts T-45 flashlight to shotgun as above.
- Tactical Shotgun Case (Fits 18 - 20" with pistol grip) \$29.95

### Moore Technical Industries

P.O. Box 86 - Dept SOF  
Bowling Green, MO 63334

We stock the entire TacStar® line of laser sights, flashlights, shotgun accessories. We also carry shotgun accessories by Scattergun Technologies® plus much more. Send \$2.00 for our complete catalog. Refunded on first order. Free with order. FAX (314) 669 - 5684

Add \$5.00 for UPS shipping. We accept MO, Visa, MC, or Cash Only COD. **No checks**, please. We ship only to the United States. Tactical Equipment for Prepared Americans



**PHOTO CARD KITS**

MONEY BACK GUARANTEE!

Our Professional quality, laminated photo cards will amaze your associates! We provide the cards, plastic laminate and easy instructions! You provide only a photo. Your Photo Card can be finished in the privacy of your home! The result is a distinctive, professional system! The highest quality cards in the US! Lost your original card? Replace it now!

only **\$4.95** C203 Bail Enforcement Agent  
Select From These Kits:

- C04  Bounty Hunter
- C13  Special Investigator
- C45  MAC-V (CIA), #1
- C60  MAC-V(CIA), #2
- C14  OCB
- C52  Air America Pilot
- C01  Press Card
- C50  Phoenix Program
- C49  Delta Force
- C25  Parachutist, Certified
- C26  SCUBA, Certified
- C07  Weapons Specialist
- C06  Mercenary
- C41  Intelligence Officer
- C212  Official Press
- C46  Special Forces
- C47  Seal Team
- C18  Pilot
- C03  Security
- C17  Int'l Drivers Permit
- C11  Private Investigator
- C02  Bodyguard
- C12  Security Consultant
- C51  Special Operations

Any Three Only **\$11.95**

Any Six Only **\$19.95**

**NIC Law Enforcement Supply**  
500 Floumey Lucas Rd. Box 5950-SV  
Shreveport, LA 71135-5950

COLOR CATALOG \$2.00 OR FREE WITH ORDER

Name \_\_\_\_\_

Address \_\_\_\_\_

City/State/ZIP \_\_\_\_\_

Card # \_\_\_\_\_ Exp. Date \_\_\_\_\_

VISA  M/C  CHK  MO 24-hour order No. (318) 688-1365 FAX # (318) 688-1367

**BAIL ENFORCEMENT**

SPECIAL IDENTIFICATION



No. 77903

**BAIL ENFORCEMENT AGENT**

**AGENT**

**LEGIONNAIRES SURVIVAL BOOT KNIFE**

ONLY **\$12.95**  
Add \$1.05 Hndl.



Double edge 440 stainless steel blade. Full tang one piece construction. Leather sheath with quick release snap and metal boot/belt clip. **Money Back Guaranteed If Not Fully Satisfied!!**

Model **K-99-A**

**WESTBURY SALES CO. DEPT BK-10-SF**  
156 Post Avenue, Westbury, New York 11590

**HK SPARE PARTS**



CATALOG \$2.00

**DELTA ARMS Ltd.**  
Box 1100-F Delta, Utah 84624  
(801)864-3232 FAX 864-3331

**Be a DETECTIVE**

**SPECIAL SOF PRICES! AND EARN YOUR BADGE**  
**NO EXPERIENCE NEEDED**



**MEN - WOMEN**  
TRAIN AT HOME FOR AN EXCITING PART OR FULL-TIME CAREER AS A PRIVATE DETECTIVE. START YOUR OWN AGENCY OR WORK FOR OTHERS. LEARN ALL THE LATEST TECHNIQUES FROM THE EXPERTS.



**EST. 1973**  
**YOU ARE TAUGHT BY FORMER MILITARY INTELLIGENCE SPECIALISTS, POLICE AND PRIVATE DETECTIVES. "THE ONLY COURSE OF ITS KIND." YOUR PAST EXPERIENCE COMBINED WITH THE UNIQUE GLOBAL PROGRAM**

**WILL MAKE YOU A PRIVATE DETECTIVE.**



"Now earning \$100,000 a year as a P.I. Thank you Global."  
A.R. Texas

**CALL NOW 617-721-4292**

**NO OBLIGATION • NO SALESMAN**

**GLOBAL SCHOOL OF INVESTIGATION**  
171 S. PARK ST. STONEHAM, MA 02180

NAME \_\_\_\_\_

ADDRESS \_\_\_\_\_

CITY \_\_\_\_\_ STATE \_\_\_\_\_ ZIP \_\_\_\_\_

**FREE INFORMATION**

**COVERT ACTION TANTO**

ONLY **\$19.95**  
+\$3.00 SHPG.



Black silent and rugged, this knife will get the job done. Features a 6" blade, sure-grip Zytel® design, "skull crushing" pommel, and incredible penetrating power. 30 day money back guarantee!

Send check or M.O. to: **Cutlery Connections\*2101**  
W. Broadway #171 • Columbia, MO 65205-6018

**AUTOMATIC KNIVES**

Only **\$29.95** each!

+ \$5.00 shipping and handling

Protection at the touch of a button! Lightning fast, stainless steel blade and shock resistant handle.

Save \$10 on orders for 2 or more! 24 hr. order turnaround and best price guaranteed (slight delay on personal checks). Don't delay, order now! C.O.D. orders call toll-free anytime. Send check or M.O. + \$5 Shipping to:

**Cutting Edge Ent.**  
2101 W. Broadway #171  
Columbia, MO 65205-6018  
**1-800-554-5880**

**30 DAY MONEY BACK GUARANTEE!**



Don't get fooled by Frauds  
**100% GUARANTEED**  
Anabolic Muscle Building  
**STEROIDS**  
Replacement

This product is to be taken **orally.**

No harmful side effects.

S&K Performance Product **Boron!**

Can dramatically increase your **Testosterone levels up to 300%!** Higher Testosterone means faster, easier muscle growth! Greatly enhance your physical appearance literally sculpting your own body with huge healthy, hard muscle.

Get that lean awesome body builder physique now with one 3 month cycle for only **\$15.95!**

If you are not completely satisfied with the growth you obtain within 15 days return it for a full refund!

**Money back guarantee!** To get your super anabolic growth cycle from:

S&K Performance Products

Order Now!!!



\$15.95+shipping



**1-800-398-6946**

24hrs. 7 days a week

C.O.D's welcome add \$4.00 shipping.

Check or money order send with

\$15.95+shipping and handling to:

**S & K Labs, 2637 E. Atlantic Blvd. Suite 101,**  
Pompano Beach, FL 33062

**Factory New, Military NIGHT VISION**

**Binoculars, Scopes & Goggles From Only \$399.00!**

Previously unavailable to the civilian market. Now you can own starlight technology originally developed for the Russian Military and KGB.

Great for camping, boating, photography, nocturnal wildlife observation, survival, security, surveillance - or just plain fun!



**Baigish-BN-453**  
Starlight  
3.2 Magnification  
Only \$545.00!

**Baigish-6**  
Starlight  
Panoramic Viewer  
Only \$1349.00!

Plus \$12.00 S&H. Californians add 7.75%

**ONE-YEAR WARRANTY**  
**30-DAY UNCONDITIONAL**  
**100% MONEY-BACK GUARANTEE!**



**CALL NOW: 1-800-424-8222**

**M • O • R • O • V • I • O • N**

219 Broadway, Suite 307

Laguna Beach, CA 92651

Tel: 714/497-4683 • Fax: 714/497-1270

**FREE CATALOG**

## THE HOUND DOG

### Sniffs Out Hidden Transmitters

Throughout the world today, corporations, professional men, and businessmen are spending millions annually to insure privacy in their offices and homes where important plans and policy making decisions are discussed and formulated. The "HOUND DOG" is a wise investment for anyone who has reason to believe that an eavesdropping device is now hidden, or may be hidden in the future, in either home or office. No radio transmitter, no matter how well it may have been hidden, can escape detection by the "HOUND DOG".

The "HOUND DOG" is an advanced electronic instrument designed for the sole purpose of locating hidden transmitters. An average size office or room can be thoroughly searched in only a matter of minutes. The "HOUND DOG" sniffs out any transmitters hidden in pictures, walls, desks, chairs, etc., regardless of their operating frequency.

The "HOUND DOG" is simple to use. Single knob adjustment calibrates the meter and any transmitter signal received is indicated by the meter movement. By simply sweeping the probe past walls, chairs, pictures, desks, etc. the presence of any transmitter will cause a rise in the meter reading. The meter reading will continue to rise as the probe approaches the transmitter.

We believe you will find the "HOUND DOG" outperforms most other units selling for several times the price. This item has been built since 1962. Each one is backed by a 3-year warranty by us.

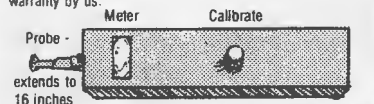

Probe - extends to 16 inches

**\$195.00**

USES A COMMON RADIO BATTERY

### Super Powerful FM TRANSMITTER

Many times more powerful than other transmitters. Transmits up to 1/4 mile to any FM radio — Easy to Assemble Kit — up to 6V battery (not incl.)

**\$19.95**

Call 407-725-1000 or send \$195.00 plus \$5.00 shipping for Hound Dog and \$19.95 and \$1.00 shipping for FM Transmitter to USI Corp. P.O. Box SF-2052, Melbourne, FL 32902. COD's OK. For a catalog of transmitters, voice scramblers & other specialty items enclose \$2.00 to USI Corp.

## Become a gun repair expert!



Professional-level home study trains you to do expert work on all kinds of firearms. Call today for free literature: 800-223-4542.

Name \_\_\_\_\_ Age \_\_\_\_\_  
Address \_\_\_\_\_ Phone (\_\_\_\_) \_\_\_\_\_  
City \_\_\_\_\_ State \_\_\_\_\_ Zip \_\_\_\_\_

School of Gunsmithing, Dept GGL171  
6065 Roswell Rd., Atlanta, Georgia 30328

### A SIMPLE REACTION TO AFFIRMATIVE ACTION



#### Show support for your heritage!

Black T-shirt - high-quality design in full color  
M - XL \$15 / XXL \$17 / U.S. add \$3 ea S&H  
Foreign add \$6 ea S&H / Ca. res add 8 1/4% tax  
Catalog \$1 & 29c stamp / Send ck or mo to:  
P I G (Politically Incorrect Graphics)  
P.O. Box 2147-Dept SOF, Orinda, CA 94563  
Credit Cards welcome. Call (510) 531-5028

# TIGER Sporting KNIFE

### The Ultimate Tool of the Trade!

Only \$39.95  
\$2.00 S&H

Money-Back Guarantee!



Two-Position, Locking Stainless Blade  
Closed-fist Grip for Sure Handling  
Rugged Field Construction

Send Check or Money Order to:

Trade Partners Group • P.O. Box 5120-375  
Chino Hills, CA 91709

## CAPITALIZE ON CRIME

### IT CAN PAY

**HUGE PROFITS!**  
CRIME PREVENTION IS A MULTI-MILLION DOLLAR BUSINESS!  
OUR DEVICES SELL LIKE CRAZY

FREE WHOLESALE CATALOG

We carry the best line of security sprays, stun guns, personal sound alarms, burglar alarms and much more. We specialize in offering the best security products at the very best wholesale prices.

10% Pepper Sprays      Personal Sound Alarm

**Key Chain Sprayer**      4 oz. Fogger

Retail \$19.95      Retail \$22.95      Retail \$34.95  
Sample \$7.95      Sample \$10.95      Sample \$10.95

Electronic Stun Guns

**Security Plus 100,000 Volt**      **Security Plus-Maxo 200,000 Volt**

Retail \$69.95      Retail \$119.95  
Sample \$29.95      Sample \$39.95

**CALL OR WRITE TODAY!**  
We are committed to your success.  
Crime does not wait! Will you?

**L.A. LAW ENFORCERS**

1005 N. 1st Street., Dept SW  
Yakima, WA 98901  
(800) 967-8133 • FAX (509) 575-1875



## Target to Adventure!

U.S. Cavalry has everything you'll need for your adventurous lifestyle! Over 100 full-color pages loaded with shooting accessories, knives, hi-tech optics, camping and survival gear, GPS's, official and tactical uniforms, communication equipment, flashlights, boots, military memorabilia, personal protection devices, target practice aids and much more. **Guaranteed 100% satisfaction!** For your catalog, send your name, address and \$4.00 to:



Dept. SF 2855 Centennial Ave.  
Radcliff, KY 40160-9000

See our catalog on color video

Cross w/ chain  
\$20.00

War Order Badge  
\$24.00

Olympics w/ chain  
\$22.00

These are full size. Not miniatures. Made from originals. We have most complete stock of WWII German badges-caps, etc. in U.S.

**WWII U.S. CAP**  
U.S. Officer's Cap (new from original U.S. maker). Tan with brown leather visor, chin strap and U.S. Eagle pin. State size S, M or L, \$89.00. Have few Olive Drab, Wool \$94.00

**GENERAL'S CAP**  
State S, M or L Size=\$110.00. Shoulder Boards, Set=\$31.00. Collar Tabs, Set=\$18.00. Complete, Knights Cross=\$21.00. The Complete Set. IN STOCK. ALL 4=\$149.00

**AFRIKA-KORP. CAP & GOGGLES**  
German 1942 Mfg. ORIGINAL sand & dust goggles. Still in their pocket pouch. Tan Ofc. caps=New REPLICA. State S, M or L size, Both Only \$39.00

**U-BOAT CAPTAIN'S CAP**  
White top Gold insignia and visor braid. Leather chin strap. State size wanted \$120.00 Knights Cross with ribbon and oak leaf with swords \$21.00

**S.S. OFFICER'S BLACK VISOR CAP**  
State S, M or L \$84.00 We pay postage.

For the back of your jacket...Flying Tigers BloodChit Patch 7" X 11" good reproduction=\$25.00

**Video**  
Our catalog on VHS video only \$20.00 postpaid free w/ \$25.00+ order.

W.W.#2 Ltd. Box 2063-F, St. Louis, MO. 63158

# BULLETPROOF VEST

Will stop the .357 Magnum, 9mm and 00 Buck. Meets and exceeds "Threat Level II-A" tested in accordance with the NILECJ-STD-0101.01. Weighs 2 3/4 lbs. Fits easily under T-shirt.



Front & Back Protector \$220  
Detachable Side Panels \$45  
Chest Trauma Plate \$35

Officially tested by the U.S. Government Edgewood Arsenal at the Aberdeen Proving Grounds under the U.S. Department of Justice Standards. State height, chest and waist measurements.

## MATTHEWS POLICE SUPPLY CO.

(a division of David Matthews, Inc.)  
P.O. Box 1754 Dept. SF  
Matthews, N.C. 28105  
Ph. (704) 847-8793 FAX: (704) 847-4447

# GUN PARTS CORPORATION

SUCCESSORS TO NUMRICH ARMS

## THE WORLD'S LARGEST GUN PARTS SUPPLIERS PRESENTS ITS NEW #18 CATALOG

Featuring an inventory of over 450 million gun parts we have for sale. A 650+ page catalog with exploded drawings that are invaluable to the gunsmith or hobbyist. Commercial, military, antique and foreign gun parts (many exclusively available from us) are listed and priced along with accessories, surplus & specialty items. A veritable encyclopedia of gun parts, this catalog will pay for itself time and time again with information and time saved in identifying parts.

U.S. \$5.95 SURFACE FOREIGN - \$10.95  
send 5 AIRMAIL WRITE FOR QUOTE  
GUN PARTS CORP. BOX SF1094, W HURLEY, NY 12491  
914-679-2417 FAX 914-679-5849

## NOW YOU CAN OWN THE ULTIMATE COMBAT/SURVIVAL KNIFE



## GIANT 15 1/4" OVERALL

10" 420 J2 stainless steel blade. Holds complete survival kit. Hurry! While Supplies Last!

**Limited Time Offer**  
**Money-Back Guarantee!**  
**Super Low Price at \$39.95** S&H  
**1-800-385-4103** CREDIT CARDS AND C.O.D.  
OR RUSH CHECK OR MONEY ORDER FOR \$44.95 TO:  
**HURRICANE INTERNATIONAL**  
PO Box 109, Cold Spring Harbor, New York 11724

# STEROIDS

## D-BALL TEST JET DECA

Anabolic Steroids increase Testosterone levels to Build Muscle Mass and Strength

Now there is a safe and effective replacement for steroids. **Boron\***. Tens of thousands have used **Boron** from JTR Labs to successfully replace steroids without the harmful side effects. *Guaranteed*. Check out these results. All from **Boron** users.

"...20 pounds of muscle in three months..." Willie Beck III. AL

Terry Goetz. VT. Put 90 pounds on his bench. "...two inches in my chest..." J. Ramsey. TX

"...its the extra edge I needed..." Charles Walters, Military

*All these amazing gains using Boron.*

For your own Huge Increases - Order your 3 month cycle of **Boron** today. Only \$19.95, shipping included. Blow away your competition and order now.

\*Boron is a safe, 100% natural nutrient

COD's, Credit Card, Catalog orders call:

1-800-962-4769....ask for dept.#656

Order lines open 24 hours 7 days a week

Send check or money order to:

JTR LABS  
10230 Bach Blvd.  
Dept.#656  
St. Louis, MO 63132

## HOME OF THE LIFETIME GUARANTEE

**WARNING:** Accept no imitations or copy cats. JTR Labs, gives you the highest quality Boron. For 6 years. Unlimited Guarantee.

## After 'Nam: A Police Story



**Howard Dale thought his warring days were over when he left Viet Nam. Then he became a cop...**

Rich in detail and human passion, this is a frank and "street level" story of how one Marine Vietnam vet's war did not stop when he came home; Howard Dale merely changed uniforms from Marine to police officer.

"A book of artistry and great significance. A powerful novel that is long overdue."

— Chuck Dean, author of *Nam Vet: Making Peace With Your Past*

Send only \$7.95 — full price— including postage, etc., payable to:

Carl Ax  
P.O. Box 25  
Earlville, PA 19519

## MMC UNIVERSAL FN FAL/LAR SCOPE MOUNT

Fits all models including Paratrooper.



**59.95**

Plus \$4.00 Ship/Hand  
TX Res. Add \$4.65 Tax

## MMC UNIVERSAL AK SCOPE MOUNT

Fits all AK (KALASHNIKOV) type firearms.



**39.95**

Plus \$4.00 Ship/Hand  
TX Res. Add \$3.10 Tax

Both mounts are lightweight, ultra low profile & rigid. Unobstructed view of iron sights over mount. Field stripping capabilities retained with scope and mount in place.



MINIATURE MACHINE CORP.  
606 Grace Ave. / Dept. SOF  
Ft. Worth, TX 76111 / (817) 831-0837

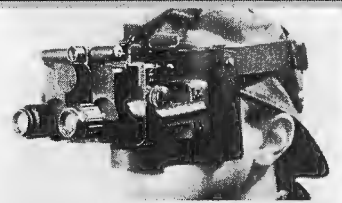

## HANDS-FREE NIGHT VISION

**EXCLUSIVELY** from HITEK International, these proprietary goggles are manufactured at our own factory and are full of features not available even on much more expensive units. Now offered to you **factory-direct**. Great for use on boats, off-road vehicles or wherever you need both hands free while seeing in the dark!

We offer a full line of low-cost, high-performance Night Vision binoculars, goggles, spotting & rifle scopes.

**NEW UNITS \$495!** Plus \$12.00 S&H  
**FROM ONLY**

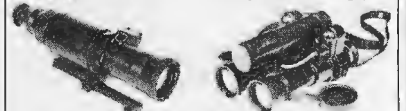

**30-Day Money-Back Guarantee!**

Call Now: 1-800-54-NIGHT

VISA - MC - AMEX - DISCOVER  
Californians add 7.75% sales tax

**HITEK**

490 El Camino Real, Redwood City, CA 94068  
TEL: 415-363-1404 • FAX: 415-363-1408

Use of these products for hunting & other activities may not be legal in your area

100% Cotton/USA/Pre-shrunk  
**T-Shirts!**



(Back of Shirt)

**FBI CIA DEA IRS ATF COPS**

6 designs! Navy shirt w/ White  
Wear 'em at the gym, range,  
beach, workouts etc... They're fun!  
Small print on front Large on back

**Only \$15.00!!**

Order now and get 3 for \$40!  
plus \$1.50 for shipping (2-6 add \$3.00)  
Sizes: L and XL (XXL add \$1.50)

Check or M.O. to: J. Black  
P.O.Box 76581

Washington, D.C. 20013-6581

D.C. residents add 8.5% tax (\$1.28)  
per shirt.

Notice: These shirts are not authorized  
by, nor connected in anyway to any  
government agency.

**.22 L.R. AMMO  
FOR SILENCED WEAPONS  
Subsonic Hollowpoint Ammo**

No Muzzle Crack! Less Noise for any .22! Loads  
flawlessly in all guns! Manufactured in Germany.  
Used by Israeli Mossad and numerous Elite Para-  
Military Forces! Quietest .22 L.R. Ammo in the world!  
Matchgrade Accuracy! No License Required to Buy!  
UPS delivery only/No PO Boxes! Order now!

Box of 50, \$6.95; + 3.50 S&H  
3 Boxes for \$18.95; + 5.00 S&H

Name \_\_\_\_\_  
Address \_\_\_\_\_  
City/St/Zip \_\_\_\_\_  
Card # \_\_\_\_\_ Exp. \_\_\_\_\_  
Visa  M/C  M/O  Check  Free Catalog  
with order!

NIC Law Enforcement Supply  
500 Flournoy Lucas-PO Box 5950-F22  
Shreveport, LA 71135  
24-Hour #318-688-1365 FAX #318-688-1367

**LILE HANDMADE  
KNIVES**

**"ARKANSAS KNIFESMITH"**

*Excellence since 1970*

Designer & Maker  
**FIRST BLOOD & RAMBO**

**Deathwind  
Hunter or Military**

**Deathwind  
Hunter or Boot**

Visa & Mastercard - also Lay-away  
2721 S. Arkansas Avenue  
Russellville, AR 72801

501-968-2011 Fax 501-968-4640

**SWAT/SPEC OPS/SURVIVAL  
SCHOOLS AND EQUIPMENT  
CATALOG**

This catalog contains state-of-  
the-art SWAT-SPEC OPS  
Survival Schools and Equipment  
Companies with name, address,  
phone number, and description  
of each school or company.  
Training and equipment for  
counter-terrorism, executive  
protection, explosives, combat  
diving/SCUBA, sniper, survival,  
counter-assault/pursuit driving,  
and much more are included.  
Most of the schools and  
companies in this catalog are not  
advertised on the open market.  
61 schools and 292 companies  
are listed. **IF YOU NEED  
TRAINING OR EQUIPMENT,  
YOU NEED THIS CATALOG.**

Send \$10 to:  
**SPEC OPS CATALOG**  
800-E Fairview Rd., Ste. 151 (SF)  
Asheville, NC 28803  
NO CHECKS - NC Residents add 6%



**THE  
BODY  
SCULPTOR**

Develop the body you've always dreamed of  
having. Add inches to your chest, arms, and thighs.  
Sculpt your stomach, buttocks, and calves. The  
Body Sculptor builds & tones muscles, and relieves  
stress and tension. Adjustable electrical impulses  
work your muscles more effectively than regular  
exercise. It's medically proven, effortless and safe!  
Use it at home, in the office, traveling, even while  
reading or watching T.V. Results guaranteed in  
30 days or your money back!

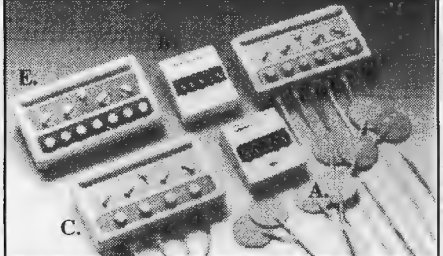

Your unit includes the following: • 24 hr. customer service •  
• Free AC wall adapter • Complete instructions •  
• 5 year Iron-Clad warranty • Free Carry Case • 30 day trial period

A. BM-1004, 6-pad model w/AC adapter, \$220  
B. BM-1006, 8-pad model w/ AC adapter, \$259  
C. BM-1008, 12-pad model w/AC adapter, \$359  
D. BM-1012, 16-pad model w/AC adapter, \$459  
E. BM-1014, 18-pad model w/ AC adapter, \$499

\*Add \$10 for ship. & handling • CA res. add 7.75% tax  
**Call Now For Immediate Delivery!**  
1-800-401-4677 (U.S. & Canada)  
or send check/money order to: David Steele  
64 Lehigh Aisle, Dept. SOF694, Irvine CA 92715

These Are The Finest Electronic Muscle Stimulators Available Anywhere!

**NOTICE TO  
CALIFORNIA RESIDENTS**

Some firearms advertised in this magazine  
may or may not be lawful for sale in California.

Those specifically not allowed for sale in California are:

- A. All of the following rifles:**
1. Avtomat Kalashnikovs (AK) series
  2. UZI and Gall
  3. Beretta AR-70 (SC-70)
  4. CETME C3
  5. Colt AR-15 series and CAR-15 series
  6. Daewoo K-1, K-2, Max 1, and Max 2
  7. Fabrique Nationale FN/FAL, FN/LAR AND FNC
  8. FAMAS MAS223
  9. Heckler & Koch HK-91, H-93, HK-94 and PSG-1
  10. MAC 10 and MAC11
  11. SKS with detachable magazine
  12. SIG AMT, SIG 500 Series, and SIG PE-57
  13. Springfield Armory BM59 and SAR-48
  14. Sterling MK-6 and SAR
  15. Steyr AUG
  16. Valmet M62, M71S and M78
  17. Amalite AR-180 Carbine
  18. Bushmaster Assault Rifle (amgun)
  19. Calico M-900 Assault Carbine
  20. Mandall THE-TAC-1 Carbine
  21. Plainfield Machine Company Carbine
  22. PJK M-68 Carbine
  23. Weaver Am Nighthawk

- B. All of the following pistols:**
1. UZI
  2. Encom MP-9 and MP-45
  3. MAC 10 and MAC 11
  4. INTRATEC TEC-9
  5. Mitchell Arms Spectre Auto
  6. Sterling MK-7
  7. Calico M-900

- C. All of the following shotguns:**
1. Franchi SPAS 12 and LAW 12
  2. Gilbert Equipment Company Striker 12 and  
SWD Street Sweeper
  3. Encom CM-55
- SOLDIER OF FORTUNE MAGAZINE**

**PRIVACY ?**

**Avoid BIG BROTHER.**  
**Best techniques for creating  
COMPLETE PRIVACY!**

- Avoid Surveillance, Eavesdropping
  - Become "Invisible" to Investigators
  - Stop Generating Financial Records
  - Communications Privacy . . . Phone, Mail
  - How to Stay Out of Government Files
  - Begin Eliminating Negative Records
  - How to Create Helpful New Records
  - Generating Quick Cash Income
  - Hiding Your Assets ■ Privacy Afloat
  - Banking Alternatives ■ "Low Profile"
  - Privacy from Taxes ■ Nomadic Living
  - Multiple Addresses
  - Hideouts, Deep Cover
  - How to "Disappear"
- ALL THE PRIVACY YOU  
WANT — and MORE!**  
Visa/MC: 800-338-8484



**EDEN PRESS**  
11623 Slater "C", Box 8410-AP Fountain Valley, CA 92728

Your Choice {  Regular P&H, \$3.00 (Please add  
 **FIRST CLASS, \$6.00 to order.** )  
(California residents please add 7.75% sales tax.)  
 Send latest Book Catalog — FREE.

Name \_\_\_\_\_  
Address \_\_\_\_\_  
City \_\_\_\_\_  
State \_\_\_\_\_ Zip \_\_\_\_\_

# ISRAEL COMMANDO TRAINING PROGRAM

OCTOBER 23 - NOVEMBER 6, 1994

Train With Commandos From  
Israel's Elite Units And Earn  
Your Israeli Paratrooper And Commando Wings  
In Two Weeks!

Led By  
Lieutenant Colonel  
Robert K. Brown  
USAR, (Ret.)



## INCLUDES ALL OF THE FOLLOWING – PLUS MUCH MORE!

Israeli Naval Commando SCUBA Training • Paratrooper Training And Jumping • Sharp Shooting And Target Range Practice • Topography Courses • Land And Water Navigational Training • Krav Maga (Hand To Hand Combat - Israeli Commando Style) • Desert Survival • Knife Fighting • Elite Intelligence Gathering And Covert Operations Training • Escape And Evasion Training • Anti-Terrorist And Hostage Crisis Situation Training • Emergency War Medical Training • Jeep Safari • White Water Rafting • Rappelling And Mountain Climbing • Bedouin Dinner Experience In The Judean Desert • War Games

Touring Of Israel In Deluxe Air-Conditioned Motor Coaches Throughout The Entire Program

Complete Land Package - Including All Of The Above (Except Airfare) \$ 2750.00 Per Person. Round-Trip Discounted Airfare Can Be Arranged Through The Israeli Sky Connection, Ltd.

All Instructors Are Former Elite Israeli Commandos And Fluent In English



SPACE IS LIMITED  
To Receive A Free Information Package - CALL NOW!

**1-800-51-ISRAEL (1-800-514-7723)**

- Outside The U.S. And In Illinois Call (708) 674-6747
- FAX Your Requests 24 Hours A Day To (708) 674-6419
- Internet E-Mail: 74150.271@compuserve.com



**THE ISRAELI SKY CONNECTION LTD.**

# CLASSIFIEDS

**CURRENT REQUIREMENTS** — 2.00 per word per insertion — \$40.00 minimum. All ads **MUST BE PREPAID**. Ad copy must be typed or written clearly with authorizing signature, a telephone number (for our files) and full payment. Advertisers offering information packets for a fee must send sample of packet (packets will not be returned). Name, address and telephone number are to be included in your word count. **EXAMPLE:** P.O. Box 693 = 2 words; 80306 = 1 word. Abbreviations such as DI, SGT, 20mm, U.S. count as one word each. Hyphenated words and telephone numbers are counted as two words. No personal services ads accepted. We reserve the right to refuse, delete or change any copy which we determine to be objectionable. Mail classified ads with payment to **SOLDIER OF FORTUNE, Classified Dept., P.O. Box 693, Boulder, CO 80306.**

## NOTICE TO READERS

**SOLDIER OF FORTUNE Magazine** is a magazine of national and international distribution. There may be products for which sale, possession or interstate transportation may be restricted, prohibited or subject to special licensing requirements in your state. Purchasers should consult the local law enforcement authorities in their area.

**READERS OF BOTH DISPLAY AND CLASSIFIED ADVERTISING ARE ADVISED THAT SOLDIER OF FORTUNE MAGAZINE DOES NOT VERIFY VALIDITY OF EVERY ADVERTISEMENT AND/OR THE LEGALITY OF EVERY PRODUCT CONTAINED HEREIN. SHOULD ANY READER HAVE A PROBLEM WITH PRODUCTS OR SERVICES OFFERED BY AN ADVERTISER, HE SHOULD SEEK ASSISTANCE FROM HIS NEAREST POSTAL INSPECTOR AND ALSO CONTACT OUR ADVERTISING DEPARTMENT. SOLDIER OF FORTUNE DOES NOT INTEND FOR ANY PRODUCT OR SERVICE ADVERTISED TO BE USED IN ANY ILLEGAL MANNER.**

## THAI ASIAN WORLDWIDE

LADIES 270 Photo Catalog  
Beautiful Women Around  
The World Seek Loving Men  
TAWL Box 937(SOF) Kailua-  
Kona, Hawaii 96745. FREE  
Brochure **808/329-5559**



Men & Women! Be A...

## PRIVATE EYE



Amazing one-of-a-kind home study course tells all! Want a life of intrigue, excitement, adventure?! Quickly learn from the experts:

- How To Earn **\$100,000** A Year As Your Own Boss!
- How To Conduct All Types Of Private Investigations, Skiptracing & Surveillance!
- How To Start Your Own Private Detective Agency!
- How To Work From Home, Part-Time or FullTime!
- No Experience Necessary, No Investment Required!

**STATE APPROVED**

Located in the Entertainment Capitol  
Of the World! **(213) 879-1165**

FREE  
DETAILS

UNITED STATES ACADEMY  
OF PRIVATE INVESTIGATION  
P.O. BOX 2133 (SF)  
BEVERLY HILLS, CA 90213

## From Original Recordings GERMAN ARMY MARCHES Vol. IV



## German Marches

\$9.95 per cassette

Complete Set of  
All Twelve Cassettes  
only \$85.00

Set Includes: 5 Army, 2  
Navy, 2 Stormtrooper,  
1 Panzer, 1 Luftwaffe  
and 1 Kavallerie  
cassette.

Hammer: Box 1393-SF  
Columbus, IN 47201

## REAL AMERICANS DRIVE AMERICAN CARS!

★★ **SHOW YOUR COLORS** ★★  
Let's Unite In Renewed Faith for Our Autos  
It's The Way To Save Our Jobs.  
3 color bumper sticker — \$3.00 ea., shipped flat  
KEEP AMERICAN JOBS, INC.  
P.O.Box 4521, New Windsor, NY 12553 - 0521

## Telephone Listening & Recording Devices

MA-100 Devices Hidden in Dual Modular Adapters! DMR-20  
FM Transmitter MA-100 Recording Adapter  
Crystal clear reception on FM radio up to 1/4 mile  
SnapKit uses phone line for power & antenna  
Starts & stops recorder when phone is used  
Plugs into standard cassette recorder  
Works when any phone in house is used  
**\$25.95** free shipping Visa/MC (214) 255-7490 **\$29.95**  
Seymour Radix Inc. Box 166055 - SF Irving, TX 75016

**SPECIAL FORCES TIGERSTRIPE** Uniforms, 1968 Vietnam Pattern worn in "The Green Berets" NEW \$72.00. Matching Boonie Hat \$16.00. A.H.A., Box 21606, Denver, CO 80221. MasterCard & VISA accepted! (204)

**FOREIGN CAMOUFLAGE!** Austria, Germany, British, French, Russian, WWII and more. Send \$1.00 for catalog: WWM, P.O.Box 552, Dept.SOF, Germantown, MD 20875. (204)

**NEW!** "Don't Tread On Me" T-Shirt/Hats. Famous Revolutionary War Protest Slogan. Unique. Gun Owners Must See! Free Brochure: DESIGNS, Box 2791/S10, Apple Valley, CA 92307. (204)

**FREE CATALOG!** Screen printed sportswear military and paramilitary designs. Send to: THE HARDLINE, 999 E. Fry Blvd. #306, Sierra Vista, AZ 85635. (205)

**UZI, AKM, OR M-16** - Wear your favorite, boldly illustrated on 100% Cotton Fruit of the Loom Tee for only \$16. SASE for Brochure. BARKER, LeParc Plaza, Suite 291E, Mt. Kisco, NY 10549. (204)

## AUTOMOTIVE

**CARS FOR \$200?** Trucks, boats, 4wheelers, motorhomes, furniture, electronics, computers, etc., by FBI,IRS,DEA. Auction listings available now. Call 1-800-436-4363 Ext. C-8258. (204)

## COMBAT TARGETS

Six original designs  
for handgun and rifle.

A new series of targets —

Combines tanks, ships and  
aircraft with special scoring  
zones. Printed in USA on  
regulation target paper.

Standard size: 10 1/2 x 12 in.

36 targets for only **\$9.95** plus \$2.00 shipping.

★ **SEND CHECK OR MONEY ORDER TODAY** ★

236 West Portal Ave. #324-B  
**RATTLER RIDGE** San Francisco, CA 94127

Name

Address

City

State

Zip

★ **SATISFACTION GUARANTEED** ★

## BOOKS & PUBLICATIONS

**MEN OF ACTION AND ADVENTURE** - Paladin Press has been described as "the most dangerous press in America." Millions of satisfied readers disagree. Outrageous and controversial books and videos on firearms, exotic weaponry, new identity, creative revenge, espionage and investigation, privacy, action careers, and more! To order our 64-page catalog send \$2.00 to: **PALADIN PRESS**, Box 1307-4GST, Boulder, CO 80306, (303) 443-7250 (206)

**SOLDIER OF FORTUNE Magazine Binder.** Holds 12 issues, \$12.00 plus \$4.00 P&H. VISA/MC accepted. No COD's. **SOF BINDER**, P.O.Box 693, Boulder, CO 80306. (205)

**BOOKS ON AFRICAN WARS**, hunting, politics. Catalogue \$2 write: Lemur Books, P O Box 1645, Albrerton, 1450, SOUTH AFRICA: Fax 011-869-0890 (205)

**WHO KILLED KENNEDY?** Assassination research materials; Videocassettes, photographs, books, unpublished manuscripts. Catalogue: \$3.00. **COLLECTOR'S ARCHIVES**, Box 2, Beaconsfield, Quebec, H9W 5T6 CANADA. (204)

**THE ART OF THE BLADE Magazine.** World's leading authority in martial-art weapons defense. This magazine is for all martial artists and edged weapons enthusiasts. Send SASE for information or \$16.80 for one year subscription. Foreign orders add \$6.00 S&H in U.S.Funds. **RONIN PUBLICATIONS**, 34-3 Shunpike Rd., Dept 162, Cromwell, CT 06416. (204)

**HARD TO FIND BOOKS.** The Outlaw's Bible \$15. Exotic Weapons \$15. Personal Defense Weapons \$10. Shadowing and Surveillance \$15. Armed Defense \$15. Privacy \$18. The Paper Trip \$17. Catalog \$2. Visa/MC orders: 1-800-635-8883. Questions: 916-725-0341. **FS BOOK CO.**, P.O.Box 417457 Dept. SF, Sacramento, CA 95841-7457. (204)

## REGIMENTAL INSIGNIA & WEAPONRY



- SAS
- RAF
- BLACK WATCH
- PARA
- RM
- CAMERONS
- RSDG
- AN
- GUARDS etc.

Import Catalog \$6.00

**BRITISH REGALIA IMPORTS**  
Department-6

P.O. Box 50473 • Nashville, TN 37205

## APPAREL

SEND **\$5.00** FOR FLYER of Soldier of Fortune Magazine logo products: t-shirts, lighters, mugs, fanny packs, etc., and receive a **COUPON FOR 20% OFF!** ake checks or money orders payable and mail to: FACETS, 576 Aztec Drive, Boulder, CO 80303. (214)

**INTERNATIONAL MILITARY Camouflage.** Fall Catalog of Genuine Military Issue Camouflage Uniforms from over 35 countries! Catalog \$1.00. I.M.S., Box 21606, Denver, CO 80221. (204)

**FRENCH FOREIGN LEGION T-Shirt** with Legion Motto in French and Latin! \$10.00 each! WOLFGANG, Box 709H, Prudenville, MI 48651. (204)

## UNDERGROUND BOOKS

Censored ..... \$25  
 The Outlaw's Bible ..... \$15  
 Personal Defense Weapons ..... \$10  
 Censored ..... \$22  
 Censored ..... \$24  
 Shadowing and Surveillance ..... \$15  
 Privacy, and How to Get It ..... \$18  
 The Paper Trip I ..... \$17  
 Underground Book Catalog ..... \$3  
 Adults Only! CA Res. Add 7.75%  
 Free Shipping! Fast Service!  
 Visa/MC Orders Call 800-635-8883  
 Customer Service 916-725-0341  
 FAX Your Order 916-725-8848  
 Checks & Money Orders Accepted  
 FS Book Co., P.O. Box 417457  
 Dept. SF, Sacramento, CA 95841

## NOSE ART

100% Cotton Nose Art T-shirts. Many designs available: Memphis Belle, Sock Time, Miss Behavin and much more. \$15.95 ea. + applicable sales tax and \$2 S.H.  
 Send \$1.95 for catalog—refundable upon purchase.  
 SEND SIZE & CHECK OR MONEY ORDER TO: **FLIGHT LINE DESIGN**  
 P.O. Box 84, Orange CA 92666, USA

## BE PREPARED

You can learn enough in your living room to someday save your life.

**TAE KWON DO** by Masters Yeon Hee Park, Yeon Hwan Park, and Jon Gerrard is the ultimate reference guide. It contains all the essentials you need to know coupled with 750 halftone illustrations that provide photographic walk-throughs.

**A MILITARY BOOK CLUB SELECTION**  
 244pp., 7% x 9 1/4". Hardbound \$24.95, paperback \$12.95. Add \$1.50 postage.  
 (In Canada \$31.95 hardbound; \$15.95 paperback; \$2.50 postage.)

TOO ENTERPRISES

P. O. BOX 0811S, BALDWIN, NY 11510

## LATIN AMERICAN LADIES!

Marry a beautiful, faithful, old-fashioned, lady from Central/South America like our President and VP did! Call (713) 896-9224 or write for a free Photo Brochure and Details to:  
**T.L.C. WORLDWIDE, INC.**  
 P.O. BOX 924994  
 HOUSTON, TEXAS 77292-4994



## THE STOMACH MACHINE

- FLATTEN THAT STOMACH
- FIRM & TONE ALL MUSCLES ELECTRONICALLY

Name \_\_\_\_\_

Address \_\_\_\_\_

City \_\_\_\_\_ State \_\_\_\_\_ Zip \_\_\_\_\_

DESERT SUN FITNESS  
 1209 S. Casino Cir. Blvd., Las Vegas, NV 89104

Home units from \$90.<sup>00</sup>

**LIVE FREE, INC.** The Survivalist Papers Program. Over 50 titles, many NEW how-to articles providing information on preparedness planning and preparations. Send a SASE to Survivalist Papers Program, P.O. Box 706, Lenoir City, TN 37771 for your free list description and order blank. (204)

**MILITARY HISTORY** and Technology Publications. For free catalogue write: **MILITARY/INFO**, P.O. Box 27640-SF, Golden Valley, MN 55427 (204)

## PAGER HOLSTER



SeeR, Inc.  
 PO Box 20983  
 Waco, TX 76702-0983

• Fast, Safe, Discreet • Press Button, Case Front Pops Open  
 • Hinges Down Allowing Quick Draw of Gun • Clips to Belt • Fits: Bauer, Davis Derringers (.22, .25, & .32), Baby Browning .25 Autos, PSP & Iver Johnson .25 NAA 22 LR 1 1/8" BBL, Freedom Arms 22 LR 1" BBL  
 \$19.95 each  
 plus \$2.00 postage & handling  
 TWO for \$34.95 plus p & h

## COLLECTORS & SPORTSMEN AUTO KNIFE BLOWOUT!

**\$39.95** ea.

2 For  
**\$64.95**  
 Plus \$4  
 Ship/  
 Hndl



#102 NATO  
 MILITARY  
 3 1/4" Stainless  
 blade. Front opening,  
 fast lever-action.

#104 THE GODFATHER.  
 Stiletto. 4" lightning-quick  
 side open stainless steel blade.  
 Lifetime Money-Back Guarantee.

Order 2 knives & get **FREE!** Swiss Army Knife.  
 Check or M.O. to **PERFORMANCE KNIVES**  
 1202 Lexington Ave (Rm 192) Dept A-10, New York 10028  
 Limited offer, ACT NOW **1-800-324-4371!**

## SOVIET MILITARIA



Soviet Military Medals, Orders,  
 Police Badges, Uniforms, Field  
 Gear, Insignia and All Related  
 Items. Special Orders Welcome.  
**FREE CATALOG.**

The Russian Trade House  
 Dept. 101, P.O. Box 2585  
 Fairfax, VA 22031  
 Fax: 703-978-4885



## BUGGED??

**EAVESDROPPING** is unbelievably widespread! Electronic Devices with amazing capabilities can be monitoring your telephone and room conversations RIGHT NOW! Are you sure you're safe? **FREE CATALOG** tells you fast! Includes Free Bonus details on fantastic opportunities now open in Counter-Surveillance field. Exciting, immensely interesting and **EXTREMELY** profitable (up to \$250/hr) full/part-time income. Call Now! **1-800-732-5000**

**COVERT INTELLIGENCE** - News on mercenaries, terrorist, espionage and operations. Samples \$3.00; \$14.00 12 copies. \$18.00 overseas. **HORIZONE**, P.O. Box 67, St. Charles, MO 63302. U.S.A. (204)

**MILITARY MONITORING GUIDE**. New book covers all phases of Military Monitoring. Military Frequencies All Services, U.S. Military Bases, Military Black Projects. Major Air Force Installations, Monitoring Equipment and Systems, Navy/Coast Guard and more \$19.95 plus \$4 Priority Mail. Universal Electronics, 4555 Groves Road, #12, Columbus, OH 43232. (614) 866-4605. (204)

**KNOW YOUR RIGHTS!** Discover some you didn't know you had. This booklet contains: Famous Quotes, Bill of Rights, Jury Rights, and much more. To order your Citizen Rule Book, send \$2 to: Jeff Monaghan, P.O. Box 165, Garden City, MI 48136-0165. (205)

**ENCYCLOPEDIA OF REVENGE** - Now in soft cover! The most devastating manual ever published! Over 1000 entries. Completely cross-referenced. It would take 15 books to equal the information jam-packed in this giant 8 1/2"x11" volume. \$19.95 plus \$3.50 shipping/handling to: **ANCHOR PUBLISHING**, P.O. Box 2630-S, Landover Hills, MD 20784. Visa/MasterCard orders call 24 hours. (800) 448-6280. Dealer inquiries invited. (204)

**MISSING PERSON** instruction manual reveals most effective techniques. Learn how to find people for fun/profit, \$15. **ACM**, P.O. Box 4021, Gaithersburg, MD 20885. (204)

## BADGES TO ORDER

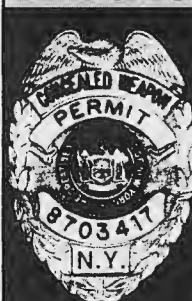

Actual Size 2"x3"

## Concealed Weapons Badge

Law Enforcement Size, Weight, Quality  
 Legal To Carry Or Wear

(COULD SAVE YOUR LIFE)

- PLEASE SPECIFY -

- Lettering Desired
- Silver \$45, Gold \$50, Two-Tone \$55
- Wallet Clip or Safety Pin Attachmt.
- State Scene - All 50 Available

Add \$3.00 UPS Shipping  
 CATALOG LSASE

ALSO  
 Badge Wallets • Photo I.D.

**MAXSELL CORPORATION**  
 4038 Powerline Rd. • Ft. Laud, FL 33309  
 (305) 568-1480

## PHOTO ID CARDS

- Drivers Licenses
- Social Security Cards
- Birth Certificates
- High School Diplomas
- Law Enf. Certificates
- College Degrees
- Military Certificates
- Trade School Diplomas

Free Information

Miller Publishing Co., Dept. SOF  
 7850 White Ln., E330 • BKF LD, CA 93309

## NUDISM LIFESTYLE: FAMILY RECREATION

Publications • Videos

\$3 for details:

LIFESTYLES-SF

Box 661268, Los Angeles, CA 90066

## BUSINESS OPPORTUNITIES

LET THE GOVERNMENT FINANCE your new or existing small business. Grants/Loans to \$500,000. Free recorded message: (707) 449-8600. (KW5) (206)

**FREE INFORMATION!** Allow the Government to finance your small business. Loans/Grants to \$687,900. Call 24 hour, free recorded message (313) 825-6700, Dept. 1422. (204)

## COLLECTORS

**MILITARY COLLECTIBLES:** WWI/WWII/Korea/Vietnam. CURRENT: Patches/Badges/Rank Insignia/etc. Catalog \$3.00. CALL (408) 295-1136 or write: **LEE-JACKSON MILITARIA**, P.O. Box 8663, San Jose, CA 95155-8663. (204)

**VIETNAM WAR INSIGNIA and Uniform List.** I mail a list of Vietnam War Militaria six times per year. Buyers receive a list free, others pay \$3 per list. Insignia are pictured so you know what you are buying. I always have a nice collection of original patches, insignia, books, maps, uniforms, field gear etc. Both U.S. and VC/NVA. I also buy singles and collections of Vietnam War souvenirs. 100% guarantee from me. Buy with confidence. **BILL BROOKS**, P.O. Box 230832, Montgomery, AL 36123. (205)

**BRITISH/SCOTTISH Militaria Collectors.** Regimental insignia and accessories of elite Regiments; including SAS; Paratroopers; Royal Marines; Black Watch; Guards, etc. Import Catalog \$6.00. **BRITISH REGALIA IMPORTS**, Department 6, P.O. Box 50473, Nashville, TN 37205. (204)

**WWII RELICS!** Cheaper than certain "well-known" relics dealers! We beat their prices for flags, daggers, medals, helmets. Six Monthly Catalogs \$15. Telephone: (612) 689-1146. **MILITARIA**, Box 261-D, Cambridge, MN 55008. (206)

**SWISS ARMY CAMOUFLAGE.** Rarest of the Rare! Hooded Jacket & Pants. Used Very Good Condition \$85.00. Camo Backpack \$20.00. A.H.A., Box 21606, Denver, CO 80221. (204)

## EDUCATION

**TERMPAPER ASSISTANCE.** 19,278 topics available! 306-page catalog—rush \$2.00. Research, 11322 Idaho, #206EX, Los Angeles, CA 90025. TOLL-FREE HOTLINE: 800-351-0222 or 310-477-8226. (214)

**Hypnosis Instant Methods**  
*\*Free Details\**  
**TRANCE**  
 P.O. Box 5022-124  
 El Toro, CA 92630

**Cosmonaut Watch**  
 Precise, 21-jewel Chronograph - \$249. Same model as worn by Yuri Gagarin. KGB Binoculars - \$49.95  
 MIG-29 Clock-\$399. FREE Shipping! FREE Brochure!  
 Visa/MC or send check/m.o. to Hall International, Ste. 200-S,  
 108 Northshore Drive, Knoxville, TN 37919, FAX (615) 588-0099  
**CALL NOW! 1-800-960-6009**

**ARREST Violators!**  
**Wear the Badge of a DETECTIVE**  
**NO PREVIOUS TRAINING NEEDED**  
 • Your spirit of adventure, danger, and self reliance can lead you to an exciting career opportunity. Solve mysteries, bring criminals to justice, protect the innocent. Experts guide you every step of the way. Men and women needed to work in challenging situations, withstanding hardships, make on the spot decisions.  
 Learn the latest investigative techniques using special law enforcement equipment . . . the same equipment used by the FBI, the CIA, and the Secret Service. Start your own investigative agency. Save up to 25% and more on all equipment. Send for free details.

**TELEPHONE LISTENING DEVICE**  
 Record telephone conversations in your office or home. Connects between any cassette or tape recorder and your telephone line. Starts automatically when phone is answered. Records both sides of conversation. Stops recorder when phone is hung up.  
**\$19.95 EACH** Qty Disc Avail  
**Super Powerful FM TRANSMITTER**  
 Many times more powerful than other transmitters. Transmits up to 1/4 mile to any FM radio - Easy to Assemble Kit - up to 9V battery (not incl.)  
 For catalog of Transmitters, Voice Scramblers and other specialty items, enclose \$2.00 to USI Corp  
 Call 407-725-1000 or send \$19.95 + \$1.00 shipping per item to: USI Corp, P.O. Box SF-2052, Melbourne, FL 32902 COD's OK

**STAR LAZER RUSSIAN WHOLESALERS**  
 For all your Russian militaria  
 Night & Day optics, badges, medals, uniforms and naval antiques  
**Sales Office:**  
 P.O. Box 1191  
 Lane Cove, NSW 2066, Australia  
 Phone: (011) 61 2-417-8824  
 Fax: (011) 61 2 417-8871  
**Speak to Bala**

*Approved by Calif. Dept. of Public Instruct.*  
**THE ROUSE SCHOOL of Special Detective Training**  
 Dept. SG410 P.O. Box 25750, Santa Ana CA 92799  
 Name \_\_\_\_\_ Age \_\_\_\_\_  
 Address \_\_\_\_\_  
 City/State/Zip \_\_\_\_\_

**ISRAEL MILITARY PRODUCTS**  
  
**AIRBORNE T-SHIRT S-XXI \$11+\$3 POST**  
 IDF WEBBING, HELMET, INSIGNIAS, UNIFORMS, T-SHIRTS  
 CATALOG \$2 (FREE WITH T-SHIRT ORDER)  
 IMP P.O.B. 31006, TEL AVIV 61310, ISRAEL

**.625 MAGNUM™**  
**-BEWARE-**  
 The World's Most Powerful Blowguns are DOWN & DIRTY!  
 Write or Call For Immediate Info.  
**J.W. McFARLIN COMPANY**  
 P.O. Box 209, Lake Havasu City, AZ 86405-0209  
 Tel. (602) 855-8095

**EMPLOYMENT**  
**OVERSEAS, STATESIDE.** \$100-\$1,000 daily. Now hiring. FREE list. ZINCS 117, Box 585, Dearborn, MI 48120 (208)  
**PROFESSIONAL CRAFTED RESUMES** and Job Search Books/Report. Money back guarantee. FREE information: DMDSOF, P.O.Box 322, Natrona Heights, PA 15065. (204)

**GORGEOUS ASIAN WOMEN**  
 DESIRE PENPALS, ROMANCE, MARRIAGE!  
 Details, color photos — \$1:  
 P.I.C., P.O. Box 461873-SF, Los Angeles, CA 90046

**Military Medals & Books Catalogs**  
 Catalog Available on: **BOOKS**  
 • Military History  
 • Medals  
 • Uniforms  
 • Weapons  
 Over 35 Pages  
 Send \$2.00  
 Catalog Available on: **MEDALS**  
 • Worldwide Medals  
 • Wings & Badges  
 • Mini Medals  
 • Ribbon Bars  
 Over 60 Pages  
 Send \$1.00  
**Over 1,000 Titles & Medals in Stock!**  
 Pieces of History  
 P.O. Box 4470 - Dept. SF  
 Cave Creek, AZ 85331 - (602)488-1377

**FIREARMS - ACCESSORIES**  
**NATIONAL MILITIA NEEDS YOU!** United States Special Field Forces: Government chartered, needs leaders as volunteer officers in home town. Courageous, self-reliant 18 or older. \$5 brings information and application for commission. Write: GENERAL, Box 432, Camp Bradley, FL 32066 (212)

**FREE FULL YEAR SUBSCRIPTION...**  
**SamAndy SURVIVAL TIMES NEWSLETTER & CATALOG**  
 BE PREPARED! HELPFUL TIPS & PRODUCT FACTS HELP YOU FACE THE FUTURE WITH CONFIDENCE - NO MATTER WHAT! YOU OWE IT TO YOUR FAMILY TO HAVE THIS INFORMATION - FOR YOUR FREE 1 YEAR SUBSCRIPTION. SEND YOUR NAME, ADDRESS & PHONE # TO SamAndy SURVIVAL TIMES NEWSLETTER, DEPT JAG, P.O. BOX 141741, IRVING, TEXAS 75014 Fax: 214-869-2087 Dept. JAG

**BE A PARALEGAL!**  
 Attorney-instructed home study prepares you for an exciting future in America's hottest career. Free booklet: 800-223-4542.  
 Name \_\_\_\_\_ Age \_\_\_\_\_  
 Address \_\_\_\_\_  
 City \_\_\_\_\_ State \_\_\_\_\_ Zip \_\_\_\_\_  
**The School of Paralegal Studies, Dept. LLL171**  
 6065 Roswell Road, Atlanta, Georgia 30328

**IMPORT/EXPORT.** Firearms, parts, related equipment, Licensable items our specialty. CTS TECHNOLOGIES, INC., P.O.Box 20943, Atlanta, GA 30320. (204)

**INSTRUCTION**  
**SKS FULL AUTO CONVERSION.** No modification, alteration or deletion of original parts. Simple illustrated instructions \$10. SARDAUKAR, Box 38531-S, Germantown, TN 38138. All BATF Rules Apply. (204)

**FOR SALE**  
**UNIFORMS FROM** Around the World, Camouflage Uniforms from over 50 Countries, 16-page Catalog \$1.00. L.M.S., Box 21606, Denver, CO 80221. (204)  
**160 ACRES LARGE TIMBER** \$52,000; adjoining 68a. beautiful timber \$34,000; 100a. 1/2 timber 1/2CRP \$64,000; 240a. with 160a. CRP rest timber \$108,000; 1180a. ranch nice home, timber \$3.75/a. Century 21 Heartland Realty, John Meek Sales (816) 872-6889. (204)

**KNIVES - BAYONETS**  
**COLD STEEL, Spyderco, Gerber, SOG** and more. Huge discounts! Free list. KNIVES PLUS, 2467 Interstate 40 West, Amarillo, TX 79109. (806)359-6202. (204)

**World's Most Fascinating Police Catalog!**  
 112 pg. Catalog  
 Badges; ID Cards;  
 Books; Clothing;  
 Ammo; Weapons  
 Spy Equip; Posters;  
 Hats & more!  
 World's Best Catalog!  
 Send \$3.00 for Catalog, or Call 1-900-226-2444 for RUSH shipment! FREE \$3.00 Coupon included with each catalog!  
**NIC, inc.** Box 5950-FC; S port, LA 71135; (318) 688-1365

**FREE**  
**FREE CATALOG.** Military/Education Diplomas, Certificates, Awards, any high school, university, government dept. New European & corporate coat of arms. COUCH POTATO PUBLISHING 4211 Little Road, Suite 9, New Port Richey, FL 34655, U.S.A. (204)

**MISCELLANEOUS**  
**RUSSIAN LADIES,** truly beautiful, educated, want to meet YOU. Free color photobrochure. Russia46, P.O.B. 888851, Atlanta, GA 30356, (404) 458-0909, Anytime. (204)  
**NEW IDENTITY!** Everything included to completely change identity. Driver's license, Social Security, Birth Certificate, Identification Card, Complete Instruction Booklet. Send \$29.95 to "CAS", P.O.Box 2392, Redondo Beach, CA 90278. (204)

**BEAUTIFUL MEXICAN WOMEN** seek romance!! Free photos, full information. LATINIS, Box 1716 (TN), Chula Vista, CA 91912. (619) 685-5195. (204)

**DRIVER'S LICENSE** (entire USA). Must be U.S. citizen. Free application, information. MAXSELL, Box 23021, Ft. Lauderdale, FL 33307. 305-568-1480 (24 Hrs.) (205)

**MALE POWER PACK.** Creates/builds muscle, strength, stamina, endurance. Can elevate testosterone level 200%! Enhances virility. Safe. ON SALE: 1-800-878-8844. (204)

**ASIAN WOMEN** Desire Correspondence! Overseas, sincere, attractive, traditional. Free details! Sunshine International Correspondence, Box 5500-ZH, Kailua-Kona, Hawaii 96745 (808) 325-7707 (204)

**PHOTO I.D. CARD** (50 states). Send photo, eye/hair color, height, weight, birthdate. \$15.00. MAXSELL, P.O.Box 23021, Ft. Lauderdale, FL 33307. (206)



**SURVEILLANCE**  
& COUNTERSURVEILLANCE Electronic Devices

Vehicle Tracking • Bug/Phone Tap Detectors • Caller ID  
• Covert Video• Phone Scramblers • Voice Changers  
Shotgun Mics • Transmitters • Locksmithing • AND MORE!

7 - Hour Telephone Recorder  
Tapes incoming/outgoing phone calls automatically. **\$125.00**

**FOR CATALOG SEND \$5.00 TO...**  
P.O. Box 337, Buffalo, NY 14226 (716) 695-8660

**Need NEW ID ?**  
**CREDIT • PRIVACY**

OUR BOOKS HELP YOU GET: New Identity & credit.  
• Jobs in 48 hours. College degrees. ID by mail.  
• Cash income. Private loans. Asset protection.  
• Offshore banking. Foreign passports & MORE!

**FREE 40 pg. PRIVACY CATALOG: 800-338-8484**  
EDEN PRESS • Box 8410-PS • Fountain Valley, CA 92728

*Personally Signed To You*  
**"COMBAT BABE"**  
**\$10 POSTPAID**  
MISS BUSY BODIES, Inc.  
2809 Bird Ave., Suite 269  
Miami, FL 33133

**SEXY SYLVIE POSTERS**

**Russian Ladies, truly beautiful, want to meet you!**

260 Beautiful, Educated Russian Ladies are sincerely seeking friendship and marriage with American men of all ages. We have selected these ladies from over 4800 applicants.

**FREE Color Photo Brochure**  
**RUSSIAN CONNECTION**  
Dept. 100 • P.O. Box 888851 • Atlanta, GA 30356  
(404) 458-0909 (24 hours)  
EXCITING MOSCOW TOURS AVAILABLE

**BEATING RETREAT (60 Minutes)**  
VHS ONLY \$39.95  
By the massed bands of the Royal Marines. A spectacular rousing performance.

**BRITISH REGALIA IMPORTS**  
Department 6  
P.O. Box 50473, Nashville, TN 37205

**EMERGENCY PASSPORTS**  
TRAVEL INCOGNITO

AFRAID TO TRAVEL AS AN AMERICAN? NEED ALTERNATE IDENTIFICATION? FOR TRAVELERS AFRAID OF BEING SINGLED OUT BY TERRORISTS, HIJACKERS OR KIDNAPPERS, WE OFFER PASSPORTS FROM VARIOUS COUNTRIES.

"AN AMERICAN? — NOT ME!"  
CUSTOM MADE LEGAL SECOND PASSPORTS WITH YOUR PHOTO AND PERSONAL INFO PLUS TWO BACK-UP I.D. CARDS - \$135.00

SEND \$2 FOR INFO AND BROCHURE  
**SAFEGUARD SERVICES**  
P.O. Box 689-F Ely, NV 89301  
(702) 289-4229

HAT PINS - PATCHES - FLAGS  
1500+ MILITARY DESIGNS  
FREE 24 Page ILLUS. CATALOG  
WE DO CUSTOM WORK  
Dealer Inquires Welcome

**HOOVER'S MFG. CO.**  
4015SF PROGRESS BLVD.  
PERU, IL 61354  
(815) 223-1159, Ask For David

**FREEDOM COUNTRY**

20 BIG acres in WESTERN MONTANA, starting at \$9850. Trout fishing, backpacking, camping. Elk, deer, moose, bear. ADJACENT to National Forest, near established towns. Yellowstone and Glacier National Parks nearby. GUARANTEED ACCESS, INSURED TITLE, WARRANTY DEED. FREE color brochure, photos, maps.

FULL MONEY-BACK GUARANTEE  
"Video Available"  
CALL TOLL FREE 1-800-592-5990  
**TREASURE STATE RANCHES**  
210 Milwaukee Street, Dept. S  
Deer Lodge, Montana 59722 — (406) 846-1000

**UNUSUAL BOOKS**  
MANY AVAILABLE NOWHERE ELSE  
100's of Titles to Choose!

CREDIT • EMPLOYMENT • EXOTIC WEAPONRY • MARTIAL ARTS • PRIVACY • NEW IDENTITY • DISGUISES  
• SURVEILLANCE • FIREWORKS and Much, Much More!  
Best Prices and Selection. Money Back Guarantee.  
Catalog . . . \$1.00

**ALPHA PUBLICATIONS**  
PO Box 308-M Sharon Center, OH 44274

**100% RUSSIAN MILITARY**  
Amphibious Combat Watches

Built in Moscow by the Russian Military, the handcrafted MVM Sport is one of the strongest watches in the world.

- Water Resistant to 100ft
- Crystal Mineral Glass
- Leather Watchband
- 17 Jewel Movement
- Phosphorescent dial
- Shock/Heat Resistant
- Smooth Rotating Bezel
- Rare Military Collectible

1 Year Manufacture Guarantee!

The gold case houses a durable precision calibrated movement crafted for air, sea, or ground combat.

Supplies extremely limited...act now!  
Please send Check  Money Order   
of \$49.95 ea plus \$2.00 S/H To:  
Avant International P.O. Box 3096  
Beverly Hills, CA 90212-0096 \*priced thru 11/31/94

**EXCEPTIONAL VIDEOS!**  
For the EXCEPTIONAL MAN  
**FREE CATALOG with order**

ONLY 50¢ ea.

- 10 VIDEOS \$5
- 20 VIDEOS \$10
- 30 VIDEOS \$15
- CATALOG plus 3 FREE VIDEO New Customer Bonus Offer, \$3 Shipping

MOVIE MARKETING Dept. SOA4  
Box 85311, Hollywood, CA 90072

**BUMPER STICKERS.** "No Guns No Peace - Know Guns Know Peace"; "Gun Ownership: Freedom's Insurance Policy"; \$2 each. G.S.O.F., P.O.Box 702105, Tulsa, OK 74170-2105. (204)

**SPORTS TEAMS** picked to SCORE: PREDICTIONS by Experts/Pros, spreads. Daily. 1-900-407-5678 ext. 495. \$2/ min. Avg: 4 min. 18+ Ttone Avalon 305-525-0800. (205)

**BEAUTIFUL RUSSIAN WOMEN!** through overseas correspondence! Eager, sincere and faithful! FREE 32-page 500-photo catalogue. CLUB PRIMA, 13164 Memorial Drive, #233DD, Houston, Texas 77079. (713) 973-1515 anytime. (204)

**REMAILING SERVICES**

**CONFIDENTIAL ADDRESS.** Mail received here, then forwarded to you worldwide. Voicemail, tool MAILPOST, 2421SOF Pratt, Chicago, IL 60645 (312) 764-0100, (800) 890-3199. (204)

**SECURITY PRODUCTS**

**CRIMEFIGHTERS** send \$2.00 for police equipment catalog. BPEC, Box 7638, Dept. SF594, Sunnymead, CA 92552. (206)

**SURVEILLANCE**, Counterspy, Protection! Guaranteed lowest prices! Two best catalogs available \$5.00. PROTECTOR, Box 520294-S, Salt Lake City, UT 84152. (801) 487-3823. (204).

**200,000 VOLT STUN GUN** or 160,000 volt stun baton \$65.00. Brian Heimbach Company, 317 Katie, Ludlow, IL 60949. (204)

**UNTRACEABLE PHONE CALLS.** Maintain your privacy. Dial all your domestic and international calls from any pushbutton phone using your prepaid calling card. Defeats all caller I.D. systems. Send \$20.00 for 60-minutes of U.S. calls. SENSIBLE SYSTEMS, Dept 12, P.O.Box 22729, San Diego, CA 92192. Phone (619) 226-5700. (204)

**SURPLUS**

**MILITARY CLOTHING**, Gear, Boots, Jackets, Collectibles, etc. Call (408) 295-1136 for FREE catalog or write: LEE-JACKSON MILITARIA, P.O.Box 8663, San Jose, CA 95155. Foreign catalogs are \$3.00. (204)

**JOIN THE MILITIA NOW.** Defend your lives and country. Details, News, Catalog. Donation request \$5.00 CCLA, Afton, TN. 37616 Soldier (205)

**PASSPORT** establishes 2nd identity for international safe travel. Embossed, entry/exit stamps plus more. Ultimate credibility worldwide. Positive client testimonials. Quintessential quality. (305) 568-5889 (24 Hrs) (204)

**HOW TO ESCAPE** from regulation handcuffs! Houdini's secret method, and others, exposed! Send \$4.00 to P.O. Box 7740, New York, NY 10116 (205)

**BAYONETS**, military surplus, knives, collectibles and other great stuff. Free catalog. Gold Coast Trading Company, P.O.Box 3496, Costa Mesa, CA 92626. (204)

**DESERT STORM COMBAT PHOTOS.** 24 gigantic 4x6" color photos. Graphic battlefield and POW scenes. \$24.95 plus \$4 s&h. P.O.Box 1075, Dept S, Mtka., MN 53345-0075. (204)

**SEXY ORIENTAL BABES** want older men for romance and marriage. 250 girl video \$16.95. Photocatalog \$2. VOYAGE, 41 Sutter, #1309-R, San Francisco, CA 94104. (204)

**HAVE YOUR OWN PARADISE** in the heart of South America. Environment conscious community. For FREE brochure write: Z.MENDLER, 85-45 89th Street, Woodhaven, NY 11421. (204)

**PAINTWAR SUPPLIES.** Paintballs (1250) \$49.00; 12 gram Co2 \$5.00; mask & goggles \$21.99; paint grenade \$5.75, smoke bombs \$5.95; pump paint rifle \$85.99; semi auto paint rifle \$116.95; gun, goggle, mask, Co2, paintballs \$114.00. (607) 796-5229, 7 days a week 6pm-9pm (EST). S.T.P. SUPPLIES. (204)

**LOST DOCUMENTS REPLACED.** College Degree, High School Diploma, Birth, Baptismal, Marriage, Divorce, Discharge Etc. SASE to MAXSELL, P.O. Box 23021, Ft. Laud. FL 33307 (206)

**BEAUTIFUL**, Traditional, Romantic Asian ladies desire friendship and marriage. Free photo brochure. ASIAN CONNECTIONS, Box 1230, LaGrange, TX 78945. (409) 242-5820. (204)

**MEET BEAUTIFUL Asian Coeds** through correspondence. For free photo brochure write to: The Phil-Am Connection, 366 N. Allen Ave., Suite 331-F, Pasadena, CA 91106. (204)

**LIVE 24 HOURS/DAY!!** Talk to beautiful girls! 1-900-407-2273 Ext 8705. \$3.99 per minute. Must be 18 yrs Procall (602)954-4720 (205)

# PARTING SHOT

## Notice To All Politicians

**I**t is time to speak plainly for the good citizens and patriots of this nation who believe unbendingly in the Constitution of the United States of America.

Though foreign governments may disarm their subjects, we will not go down that road. We will not disarm and see our freedoms stripped away. The lessons of history are numerous, clear and bloody. A disarmed population inevitably becomes an enslaved population. A disarmed population is without power, reduced to childlike obedience to — and dependence upon — the organs of a parental state. A disarmed population will lose — either piecemeal or in one sweeping act — those basic rights for which the citizens of America risked their lives and fortunes over 200 years ago.

**We Will Not Disarm.** The right to self-protection — the internal directive of every living creature, be it mouse or man — is the most fundamental right of all. It is a right that must be exercised against the predators of the streets, against the predators hidden within agencies of law enforcement, and against the most dangerous predators of all — those to be found in government, whose insidious grasping for power is relentless and never-ending.

**We Will Not Disarm.** Not in the face of robbers, rapists and murderers who prey upon our families and friends. Nor in the face of police and bureau agents who would turn a blind eye to the Constitution, who would betray the birthright of their countrymen; nor in the face of politicians of the lowest order — those who pander to the ignorant, the weak, the fearful, the naive; those indebted to a virulent strain of the rich who insulate themselves from the dangers imposed upon other Americans and then preach disarmament.

We will not surrender our handguns. We will not surrender our hunting arms. And we will not surrender our firearms of military pattern or military utility, nor their proper furnishings, nor the right to buy, to sell, or to manufacture such items.

Firearms of military utility, which serve well and nobly in times of social disturbance as tools of defense for the law-abiding, serve also in the quiet role of prevention, against both the criminal and the tyrannical. An *armed citizenry* — the well-regulated *militia* of the Second Amendment, properly armed with military firearms — is a powerful deterrent, on both conscious and subconscious levels, to those inclined toward governmental usurpations. An armed citizenry stands as a constant reminder to those in power that, though they may violate our rights temporarily, they will not do so endlessly and without consequence. And should Americans again be confronted with the necessity of — may God forbid it — throwing off the chains of a tyrannical and suffocating regime, firearms designed to answer the particular demands of warfare will provide the swiftest and most decisive means to this end.

Any law which prohibits or limits a citizen's possession of firearms of military utility or their proper furnishings, provides an *open window* through which a corrupt government will crawl to steal away the remainder of our firearms and our liberties. Any law which prohibits or limits a citizen's

possession of firearms of military utility or their proper furnishings, being directly contrary to the letter and spirit of the Second Amendment, is inimical to the Constitution, to the United States of America, and to its citizens.

Now — today — we are witnessing the perilous times foreseen by the architects of the Constitution. These are times when our government is demanding — in the guise of measures for the common good — the relinquishment of several rights guaranteed to Americans in the Constitution, foremost among which is the right to keep and bear arms for our own defense. These are times when our government has abdicated its primary responsibility — to provide for the security of its citizens. Swift and sure punishment of outlaws is absent, and in its place is offered the false remedy of disarming the law-abiding. Where this unconstitutional action has been given the force of law, it has failed to provide relief and has produced greater social discord. This discord in turn now serves as the false basis for the demand that we give up other rights, and for the demand for more police, more agents of bureaucratic control to enforce the revocation of these rights.

Legislators, justices and law officers must bear in mind that the foundation of their duties is to uphold the fundamental law of the land — the Constitution. They must bear in mind that the unconstitutional act of disarming one's fellow citizens will also disarm one's parents, spouse, brothers, sisters, children and children's children. They must bear in mind that there are good citizens who — taking heed of George Washington's belief that arms are the liberty teeth of the people — will not passively allow these teeth to be torn out. There are good citizens who — taking heed of Benjamin Franklin's admonition that those who would give up essential liberty to purchase a little temporary safety deserve neither liberty nor safety — will surrender not one of their rights.

Those who eat away at our right to own and use firearms are feeding on the roots of a plant over two centuries old, a plant whose blossom is the most free, most powerful nation ever to exist on the face of this planet. The right to keep and bear arms is the taproot of this plant. All other rights were won at the point of a gun and will endure only at the point of a gun. Could they speak, millions upon millions of this world's dead souls would testify to this truth. Millions upon millions of the living can so testify today.

Now — today — is a critical moment in our history. Will we Americans passively lie down before a government grown disdainful of its best citizens? Or will we again declare: *WE* are the government, government functions at *our behest*, and it may not rescind our sacred rights?

Will we place our faith in public servants who behave like our masters? Or will we place our faith in the words and deeds of the daring, far-seeing men and women whose blood, sweat and tears brought forth this great nation?

Will we believe those who assure us that the police officer will shield us from the criminal? Or will we believe

*Continued on page 86*

## U.S. MILITARY INSIGNIA

1940 through Current

Large Catalog, \$3.00

SAUNDERS

Box 3133 • SF • Naples, FL 33939-3133



## SUBSCRIBE

TO THE MAGAZINE THAT  
MORE THAN 10,000 READERS  
TURN TO FOR ARTICLES,  
ADS & NEWS ABOUT MILITARY  
JEEPS, TRUCKS, TANKS & MORE!  
Full listing of upcoming rallies.

## MILITARY VEHICLES

MAGAZINE

USA: 1 Year (6 Issues) \$15 • 2 Years (12 Issues) \$25  
Canada: 1 Year \$24 • 2 Years \$44. All Others: 1 Year \$26 • 2 Years \$46

P.O. Box 1748-L • Union, NJ 07083

THE MARKETPLACE  
FOR MILITARY VEHICLES

## MEET WOMEN WORLD-WIDE

FREE 32 page photo catalog from America's most  
respected correspondence service since 1974.

### CHERRY BLOSSOMS

190FT Rainbow Ridge  
Kapaau, Hawaii 96755  
1-408-980-7488



**MILITARY SURPLUS** & Survival Items; Large  
inventory, new and used. Mail \$1. (refundable) for price  
list: HUGH WADE'S, 2120 West Reelfoot Ave., Union City,  
TN 38261-9732. (204)

**MILITARY SURPLUS.** New and used, also survival  
items. Send \$2 for catalog. REMA MILITARY SURPLUS,  
P.O.Box 7039, Canton, OH 44705. (204)

## SURVIVAL

UNIQUE 56-PAGE CATALOGUE of survival,  
defense, military, and paramilitary products. Write for  
your copy and see why we're not just blowing smoke.  
U.S.-\$3.00, Canada-\$5.00, Others-\$10.00. SIGNUS, Box  
33712-W6, Phoenix, AZ 85067-3712. (204)

IS YOUR AMMO SAFE from trapped moisture? Be  
sure! DESSICCANT PACKS 15 for \$12.00, 30 for \$20.00,  
postage paid. One DESI-PAK provides THREE TIMES  
protection needed for .50 caliber ammo can. Tyvek bag  
will not corrode metals as will some others. Two free  
humidity indicator cards to test container. Comprehensive  
application requirements. Order today. Preservation Pak,  
Inc. HC02 619 F, 29 Palms, CA 92277. (205)

## TRAINING

**BOUNTY HUNTER TRAINING** by professionals; on-  
site in Florida or at country-wide seminars. Details.  
NABEA, P.O.Box 6757, West Palm Beach, FL 33405.  
Phone: (407) 547-3630. (204)

**RANGER, AIRBORNE,** Bodyguard Training. Catalog  
and information \$7.00 (\$12.00 Foreign). USTC, 2024 N.  
Broadway, Suite 205, Santa Ana, CA 92706-2623. (714)  
547-2567. (206)

**NAVY SEAL FITNESS** Program. Gain strength and  
self-confidence. Get in shape using the methods of the  
world's most elite combat unit. Send \$10.95 to: T-N-S  
ENT, P.O.Box 16297, Seattle, WA 98116. (208).

## TRAVEL

**R & R FOR SINGLE MEN.** Dream vacation with  
beautiful, playful Filipinas, as featured on "Inside Edition".  
BIG APPLE ORIENTAL TOURS (SOF), 24912 Elkmoor  
Avenue, Bellerose, NY 11426. (204)

## BEAMSHOT™ 2000

Laser Sight

FDA APPROVAL  
PATENTED



Retail: **\$99.00**

Including:

\*Laser Sight \*Mount \*Gun Case \*Battery  
1 year warranty

\*Click Alignment System \*Window Lens \*Water Resistant

Please call the dealer near you or 800-520-8435

Quarton USA, LTD. CO.

7042 Alamo Downs Parkway, Suite 250,  
San Antonio, Texas 78238-4518  
Tel: (210)520-8430 Fax: (210)520-8433

## Support SOF Advertisers

## YOUR MILITARY MEDALS!



LARGEST INVENTORY IN THE U.S.A.!

- FULL SIZE US MEDALS
- UN AND RVN MEDALS
- MINIATURE MEDALS
- OFFICIAL RIBBONS
- RANK BADGES, PATCHES... ALL GUARANTEED!
- SKILL BADGES
- DISPLAY CASES
- MANUALS ON CLAIMING MEDALS

SEND \$2.00 TODAY FOR ALL NEW COLOR CATALOG!

MEDALS OF AMERICA  
192952 FAIRVIEW ROAD  
FOUNTAIN INN, S.C. 29644

**BACHELORS TOUR OF BANGKOK.** Steamy  
nightlife, marriage. Also pen pal, videos, guide book,  
maps, etc. FREE Brochure 1-800-669-7020 (204)

## VIDEOS

**COMPLETE SEAL Museum Video Collection!** This 12  
tape series features the best films ever made about  
Frogmen, UDTs, and SEALs. Choose from vintage DoD  
titles, rare films from private collections, and award  
winning documentaries about NAVSPECWAR "Red Cell";  
"Pro Sniper"; "Evolution of the Teams"; "SEAL Ambush!";  
"Navy SEALs: The Men Behind The Legend"; "Someone  
Special 1989"; "Navy Frogman"; "Lonely Warrior";  
"Someone Special"; "SEALs In Vietnam"; "Men with Green  
Faces"; "Submarine Trunk Training". Videos \$18 each,  
includes shipping. Send check or MO to: Sand Bee  
Corporation, P.O.Box 960311, Miami, FL 33296. (305)  
279-3393. Dealer inquiries welcome. (204)

**\$50 TO \$100 PER MINUTE** from filmmaker for  
exciting, real amateur video sequences. Do not edit.  
Immediate response by return mail. Send full video tape  
to: SEMINARS, Suite 2-244, 7040 W. Palmetto Park Road,  
Boca Raton, FL 33433. (204)

**"WORSE THAN TAILHOOK"**, screamed "American  
Journal" about "lewdness and debauchery" outside our  
former Philippines bases. We offer full-length, uncensored  
videos of these actual parties. For catalog, send \$3 to:  
B.A.O. Videos (SOF), 47 Raymond Avenue, Poughkeepsie,  
NY 12603. (204)

## - COURSES -

- COMBAT
- RECONDO
- SPL. OPS.
- SNIPER

BROCHURE  
\$3.00 Cash

SPECIAL OPERATIONS GROUP INT.  
P.O. BOX 94, TRADE, TN 37691 USA

## SKELETON KEY

FITS MOST LOCKS

(bollocks, doorlocks, & some padlocks)  
Amaze Your Friends

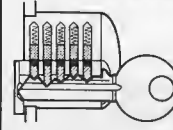

With A Lock Picking Demonstration.  
You get 3 sized metal tension keys, the slide  
pick, precise instructions & more. Note: this  
device is to be used for demonstration  
purposes only! Satisfaction Guaranteed or  
Full Refund; 2 weeks delivery.

To get this exciting device, Send Now ONLY \$8.95 + \$2 S&H to:  
Safe Marketing \* 90 W. Montgomery Av No.366SF \* Rockville Md 20850

## AK SKS MAK90



## SEND OR CALL FOR FREE COLOR CATALOG

Catalog containing rifles, parts, accessories, scopes,  
mounts, stocks, magazines, muzzle brakes and 100's  
of other products for SKS, MAK90, Hakim, AK 47 and  
other firearms.

FEDERAL ARMS CORPORATION of America

WORLDWIDE MAIL  
ORDER AND ACCESSORIES

7928 University Avenue N.E.

Fridley, MN 55432

612-780-8780 • FAX 612-780-5747

## THE SPOOK BOOK

A Strange and Dangerous Look  
at Forbidden Technology  
Mick Tynner

The book that blew the lid off Forbidden Techno-  
logy! Building Teflon™-coated bullets, re-arming  
inert grenades, secrets of titanium warheads, hy-  
persecure encryption, rocket weapons, clandestine  
pyro exposé, wearing a wire, defeating  
alarms, forbidden tech marketplace, surveillance  
photography, computer viruses, scrambling/de-  
scrambling, ultrasonic weapons, much more!  
8.5x11, 258 meaty pages, a fresh & lucid look at  
Forbidden Technology! \$33 domestic postage  
paid. Registry Distributing, 200 Union Blvd, Suite  
430, Denver, CO, 80228. Sold only to inform.



## SOLID BRASS PAPER WEIGHTS

Made from 1/2 lb of solid brass.

Polished to a smooth finish

**\$12.95 Each or 2 for \$22.50**

Send check or money order plus \$4.00 Shipping & Handling to

Bud K World Wide

P.O. Box 565 Dept SF

Moultrie, GA 31776

MC or VISA call

1-800-543-5061

**COVERT KNIFE FIGHTING** tape, documentation,  
2 concealable weapons (superior to brass knuckles).  
Ck/MO \$55.00. S.D. TEC, 1902 Ridge Rd., Buffalo, NY  
14224 (207)

**DID YOU FORGET?** The Korean War, Part 1 From  
The Pusan Perimeter To The Frozen Hell Of The Chasin  
Reservoir. The "Real" Infantry Story. Intense action  
footage, first hand accounts, a must for your library. Get  
it "before" the next Korean War! \$17.00 plus \$2.00 P&H.  
Cash, Check, M.O. TEAM C RESEARCH, 3531 S. Logan,  
Suite D-348, Englewood, CO 80110. (204)

## WANTED

**PROFESSIONAL BODYGUARDS & Investigators!**  
If you feel you have the potential to earn \$80 per hour. If  
you are professional and can assimilate confidential  
information. ACT NOW! Send \$10 for full information  
package to B.A.S.E.C., P.O.Box 147, Convention Station,  
NJ 07961-0147. (204)

# NIGHT VISION

**Best Warranty In The Business!**



INCLUDES  
SOFT CASE

**RETRON-M01**  
Gen I, latest technology



INCLUDES SOFT  
OR HARD CASE

**B-12/453/336 STARLIGHT**  
Gen I, 2.5-3.2x Interactive ICT



INCLUDES HARD CASE  
AND RIFLE MOUNT

**B-5P STARLIGHT**  
Gen II Rifle Scope



INCLUDES SOFT CASE

**OH2**  
Gen I, Hands-free Operation



INCLUDES  
SOFT CASE

**B6 STARLIGHT**  
Gen II Panoramic Viewer



INCLUDES SOFT OR  
LEATHER CASE

**PNV NIGHT HAWK**  
Gen I, 2.5x Compact Binoculars



INCLUDES SOFT  
CASE AND  
RIFLE MOUNT

**NS2-AC**  
Gen II, Day and Night Use

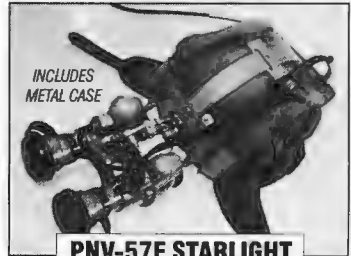

INCLUDES  
METAL CASE

**PNV-57E STARLIGHT**  
Gen I, Wide-angle Goggles

- **Finest single source of daytime & Night Vision products for every application**
- **IST 2ND & 3RD Generation Night Vision products**
- **Major Credit Cards Accepted**
- **2-Year limited warranty - ALL PRODUCTS**

## You Can Own A Piece Of History!

Available now for the first time in the United States, the original Russian-made sniper rifle...



Federal Firearms License Required for all gun purchases.

1000 LIMITED EDITION...  
RESERVE YOUR GUNS TODAY!

Unlike the Chinese or Romanian imitations which you may have seen other importers advertising as "Soviet-style", these 1000 original limited edition sniper rifles were developed by the Dragunov team and manufactured in Russia.

Select Dealers — Don't miss your chance to add one of the industry's most sought after rifles to your inventory.

Get in on the finest firearms purchase in history!

This is the rifle your customers have been waiting to own!



Mr. Dragunov

Mr. Dragunov, revered as Russia's master gunsmith, left his legacy in his life's work to only a chosen few. The authentic Dragunov rifle, considered to be one of the finest sniper rifles engineered in this century, was only available to the Soviet military and selected Eastern Block forces. His vision was that every serious sportsman and shooter might experience the capabilities of this unique firearm. That dream is now a reality with this historic buying opportunity now being presented to you.



**U.S. General Technologies, Inc.**

145 Mitchell Avenue • South San Francisco, CA 94080

Orders: 800-BUY-USGT (289-8748) • Info: 415-634-8440 • 24-hr Fax: 415-634-8452

# HERE'S MY PASSPORT TO ADVENTURE!

Sign me up for a chance to win *EXCITING prizes* and *SAVINGS* on *SOLDIER OF FORTUNE Magazine ONLY* **\$26.00**

**\$50.00**

- 1 yr sub.  
 2 yr sub  
 Sweepstakes only



PASSPORT



UNITED STATES  
OF  
AMERICA

Payment Enclosed (U.S. Funds only)

**Credit Card orders may call: 1-800-877-5207**

MasterCard  Visa Exp. Date \_\_\_\_\_

Card# \_\_\_\_\_

Signature \_\_\_\_\_

Name \_\_\_\_\_

Address \_\_\_\_\_

City \_\_\_\_\_

State \_\_\_\_\_ Zip \_\_\_\_\_

Day phone \_\_\_\_\_

BNW104

ADVENTURE, EXCITEMENT  
and FUN are waiting for you —  
**ENTER TODAY!**

\* no purchase necessary to win

\* Payment must accompany order. Offer good in the U.S. and possessions including APO, FPO addresses, for a limited time only. Canada add \$10.00 per year, (includes GST #R128476249) foreign add \$21.00/yr. Allow 6-8 weeks for delivery of first issue. Offer expires Dec 30 '94. Drawing held Jan 9 '95

**Money Back Guarantee**

# THE SURE-FIRE WAY TO GREATER ACCURACY

**ADCO MIRAGE™** Sights feature advanced reflex sight technology and top quality mil-spec workmanship. They all have no focus, parallax-free sighting for fast target acquisition and click setting for easy windage and elevation adjustments. These rugged and reliable sights are available in Black or Nickel Finish. (All models)

## The MIRAGE RANGER

30mm diam. Red-Dot Sight is ideal for action shooters. It offers the same quality as reflex sights costing twice as much. It has a large (10 M.O.A.\*) display. The economically priced 1" diam. Red-Dot Sight (not shown) is perfect for the sports shooter on a budget. It has a small (1.5 M.O.A.\*) dot.

## The MIRAGE SPORTSMAN

1" diam. sight with patented Multi-Color (Red-Green) Dot System can add an extra hour of quality hunting time to the day. It has a large (10 M.O.A.\*) display. The subdued Green Dot is ideal for early morning, in the evening, in heavy cover or under overcast skies.

## The MIRAGE COMPETITOR

30mm diam. sight assures a clear round dot. The patented Multi-Colored Dot System is the reason. If Red is not providing a clear dot because of lighting conditions, just switch the diode to Green. Ideal for indoor ranges or when any light situation makes Red a poor option. The ability to change the dot without the need of sighting in again could mean the difference between being "Champion" instead of runner-up.

RANGER

SPORTSMAN

COMPETITOR



10 Cedar St.  
Woburn, MA 01801

Contact your local dealer or distributor for further information.

\*M.O.A. stands for Minute of Angle.  
1 M.O.A. covers 1 inch at 100 yards.