



**U.S. GOVERNMENT OUT OF CONTROL:  
SPECIAL FORCES PARTICIPATED IN WACO RAID!**

# **SOLDIER OF FORTUNE**

MAY 1994  
# 48493

**AUSSIE SNIPERS  
TERMINATE WITH  
EXTREME PREJUDICE**

**ELIMINATE ALL  
PRIVATE GUN  
OWNERSHIP IN  
AMERICA —  
HGI's True Agenda  
Exposed?**

**WHAT REALLY  
HAPPENED IN WACO:  
Complete Trial  
Coverage**

**SOF CHASES  
ZAPATISTAS  
IN MEXICO**

**BLACK HORIZON:  
War In South Africa?**

**BOSNIAN COMMANDER  
CROSSES LEGION —  
PAYS ULTIMATE PRICE**



# SOLDIER OF FORTUNE MAGAZINE

**SUBSCRIBE  
AND**

**SAVE  
44%**

Savings based  
on annual newsstand  
rate of \$48.40

- 1 yr Subscription \$26.95  
 Payment Enclosed (U.S. Funds only)  
 MasterCard  Visa  
Exp. Date \_\_\_\_\_



Card# \_\_\_\_\_

Signature \_\_\_\_\_

NAME \_\_\_\_\_

ADDRESS \_\_\_\_\_

CITY \_\_\_\_\_ STATE \_\_\_\_\_ ZIP \_\_\_\_\_

DAY PHONE ( ) \_\_\_\_\_

EVE PHONE ( ) \_\_\_\_\_

BNW 594

\* Payment must accompany order. Or call 1-800-877-5207 to place your order.  
Offer good in the U.S. and possessions including APO, FPO addresses, for a limited  
time only. Canada add \$10.00 per year, (includes GST #R128476249) foreign add  
\$21.00/yr. Allow 6-8 weeks for delivery of first issue.

**Money Back Guarantee**

# Venom™



**THE MOST POWERFUL...THE MOST POTENT...THE MOST EFFECTIVE DEFENSE SPRAY AVAILABLE!!!** We're serious about your safety, and nowhere is that more evident than in our line of Chemical Defense Spray VENOM. VENOM was developed to provide you with the highest degree of non-lethal protection available. VENOM is formulated to give optimum performance from each size unit. VENOM is fast acting and hard hitting, and is effective against even drunks, drug abusers, and psychotics.

- 3 Ounce Home/Auto Unit (Maxi-Blast top).....\$24.95
- 3/4 Ounce Pocket/Purse Unit.....\$11.95
- 3/4 Ounce Keyring Unit.....\$15.95

## THE WORLDS FINEST SLIM JIM

Our premium quality car jimmy tool is made of high quality spring steel, with rounded edges and textured black rubber handle. Comes with instructions.  
**SJ100.....\$12.95**

## COBRA III+ ELECTRONIC LOCK PICK

"OPENS 99% OF ALL PIN TUMBLER LOCKS IN 7 SECONDS OR LESS"

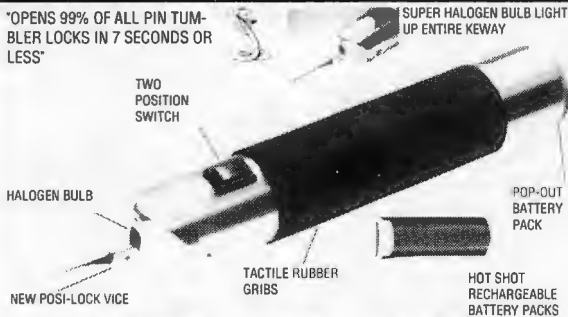

It's a technological dream come true! Finally, there's a fast way to pick open 99% of all pin tumbler locks in use today. All components are manufactured from aerospace aluminum alloys for a lifetime of quality, hassle-free service. The new Cobra III+ is jam-packed with all new features. Our exclusive high-intensity focused halogen key way light source; new tactile rubber grip; extra rechargeable "Hot Packs". The Cobra III+ is shipped complete with rechargeable Hot Pack wall charger, extra picks, tension tools, allen wrench, and shipping case.

Cobra III+.....\$399.00  
 Comes complete in die cut shipping case

For our Florida customers, and our friends in law enforcement and military - write or call for a listing of our automatic collector's knives.



CLASSIC ITALIAN



INTERNATIONAL COMBAT SWITCH



THE SPIKE



M-4



Add \$3.50 Shipping Per Order  
**CHECK, MONEY ORDER, VISA, OR MASTERCARD**  
 Full Line Catalog \$2.00



**WARNING: Check State & Local laws regarding use & lawful possession of items above. Must be 18 years or older to order.**

# SOUTHERN ORDNANCE

"The hardest hitting products in the personal defense industry"

P.O. BOX 279 • DEPT. SF • Babson Park, Florida 33827

**(813) 638-2499**

## D100 SAP GLOVES



Made of soft, pliable deerskin, these gloves have 6 ounces of powdered lead inserted across the knuckles of each fist. Discreetly effective.

- D100.....\$62.95
- D-50 (Cowhide).....\$37.95

## LEATHER SLAPPER

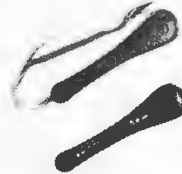

The highest quality slappers available. Constructed of smooth top grain cowhide with a leaded striking end. Available with or without a wrist loop. Made in U.S.A.  
 BBLS20.....\$19.95  
 BBLS21 (With wrist loop).....\$19.95

## POCKET PROTECTOR



Press the pocket clip and a 4 1/2 inch long, 1/4 diameter spike extends from the body of the device, providing 10 1/2 inches of potent protection. Rugged, all steel construction.

GFR.....\$55.00

## BRASS KNUCKS PAPERWEIGHT

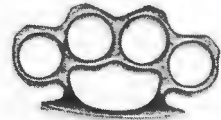

The finest product of its kind available—add a beautiful example of the metal worker's art to your collection.

- KNB.....\$13.50 ea  
 \$24.50 pr
- KNA Lightweight Aluminum.....\$8.00 ea

## Z-FORCE STUN GUNS



Z-FORCE stun devices are the best we've found! They offer reliability, high sustained voltage output and concealability - these devices are compact and powerful.

- ZF-3, 100,000 Volts.....\$44.95
- ZF-4, 120,000 Volts.....\$69.95
- ZF-Ultra, 150,000 Volts.....\$99.95

## "ACE PICK" TUBULAR LOCK PICK



Opens vending machines, pay telephones, washing machines, etc. This precision tool is made of HIGH QUALITY, HEAT TREATED STEEL, and picks tubular locks with mushroom pins. Includes a decoder and is available for center or offset locks.

- APC 7 (7-PIN).....\$74.95
- APC 8 (8-PIN).....\$74.95
- BOTH PICKS.....\$139.95



## BLACKJACK

These law enforcement weapons, once the standard of police officers throughout the country, are finely crafted from lead, steel spring, and leather. Eight ounces of nostalgic protection. Made in U.S.A.

BJKB.....\$19.95

## PXS 14 LOCKPICK SET



(PXS 17 PICTURED)

This 14 piece set includes everything you need to open most locks and doors—an assortment of picks and rakes, two tension wrenches, a broken key extractor, and cowhide pocket case. Includes the book, Easy Pickins.

- PXS14.....\$32.95
- PXS17.....\$48.95

## THE FUTURE OF GUN CONTROL IN AMERICA?

by Robert K. Brown

### MAGAZINE STAFF

Editor/Publisher ..... Robert K. Brown  
Associate Publisher ..... T. (Lefty) Wilson  
Executive Editor ..... Tom Slizewski  
Senior Editor ..... Don McLean  
Technical Editor ..... Peter G. Kokalis  
Assistant Editor ..... Lynne Robertson  
Production Director ..... Kathleen Allard  
Art Director ..... Mary Scrimgeour Jenkins  
Design Associate ..... Kristine Anderson

### Foreign Correspondents

Chief Foreign Correspondent ..... Dr. Tom Marks  
Senior Foreign Correspondents:  
Steve Salisbury • Rob Krott • Peter Douglas •  
Chuck Fremont • Morgan Tanner •  
Jack Thompson • Major Mike Williams •  
Mike Winchester • Dale B. Cooper

### Contributing Editors

*Vietnam Veterans Affairs* Col. Chuck Allen •  
*Military History* William Brooks — William H. Northacker • *Unconventional Operations* Brig. Gen. Heine Aderholt — James P. Monaghan — Maj. Robert MacKenzie • *Military Affairs* Alexander McColl • *Paramedic Operations* Dr. John Peters • *Explosives/Demolitions* John Donovan • *Aviation* Dana Drenkowski • *Africa* Al Venter • *Outdoor Affairs* Galen Geer • *Latin America* Hugo Hartenstein • *Gun Rights* Paul Danish • *Skydiving* Kitty Baran

### Business Manager

& Controller ..... Sharon Windsor  
Bookkeeper/  
Classified Advertising .... Carole Hayden  
Circulation Manager ..... Carrie Karlson  
Consultant ..... Zada Johnson  
Advertising Manager/Assistant  
Convention Director ..... Dianne McLeod  
Receptionist ..... Helena Oberg

For editorial/advertising, call 303-449-3750.  
Subscription inquiries, call 1-800-877-5207.  
For list rental contact: Dave Power, Antigone Associates 215-357-9267.

### In Memoriam

Craig Nunn — Art Director  
Lance Motley — Foreign Correspondent  
Barry Sadler — Contributing Editor

NOTICE: SOLDIER OF FORTUNE Magazine is a magazine of national and international distribution. There may be products in the magazine of which sale, possession or interstate transportation may be restricted, prohibited or subject to special licensing requirements in your state. Purchasers should consult local law enforcement authorities in their area. All data in this publication, technical or otherwise, is based upon personal experience or individuals using specific tools, products, equipment and components under particular conditions and circumstances, some of which may not be reported in the article and which Soldier Of Fortune has not otherwise verified. Soldier Of Fortune, its agents, officers and employees disclaim any responsibility for all liability, injuries or damages.

As an *SOF* reader, you know that I have long berated gun owners who refuse to become involved in actively working to defend our Second Amendment rights, or join the NRA. (For what amounts to the price of a couple boxes of ammo, signing up is a solid investment in protecting our freedom.)

Their excuses are many, but primarily it's laziness and the "My Ox Is Not Being Gored" Syndrome, i.e., the anti-gunners are not a threat to my trap/skeet shooting, small-bore competition shooting, etc...

Well, dear friends, I hope you will give these "anti-gun legislation doesn't affect me"-types a copy of the following confidential Handgun Control Inc. (HCI) document and see if they still feel the same way. This alleged internal document, leaked by an HCI volunteer, exposes the ultimate goals of diseased liberal elite anti-gunners; namely, the eventual elimination of ALL guns and ALL hunting.

Gun owners must understand the "nibbling" technique used by anti-gunners. Through political expediency, the willful use of disformation, blatant lying and subtle manipulation of an uninformed American public, the anti-gun crowd and its close ally, the left-wing media, will dramatically affect the rights of ALL gun owners.

Though Susan Whitmore, director of communications at HCI's Washington, D.C. office, categorically denies the document originated from within their organization, several of the main points are part of their "comprehensive

plan." For example, HCI openly supports requiring handgun licenses before such a weapon can be purchased (including fingerprinting), annual license fees of \$1000 for gun dealers, and bans on semiautomatic "assault" weapons and "non-sporting" ammunition.

And while Whitmore called the memo "ridiculous" and claimed HCI does not now, nor will in the future, support the banning

of all military re-enactments, of hunting on all public lands or assembly of four or more armed individuals, laws have been proposed governing these topics as well as most of the 34 other main agenda points. (Any guesses what side HCI was on when these proposed laws were being voted on?) Also keep in mind that this denial comes from an organization formed to fight handgun possession but that is now actively lobbying for controls on firearms and ammunition of all types.

Whether this "internal memo" is what it claims to be is unknown; that it's every hardcore anti-gunners' dream sheet is certain. *SOF* is publishing it as a dire warning for what the other side has in store for us if we ever let our guard down.

See "Eliminating All Private Gun Ownership in America" beginning on page 30. We have slightly shortened the text to eliminate redundancies and correct grammatical errors, otherwise it is as it was sent to us (stamped "Confidential" and on HCI letterhead stationery). ✕



SOLDIER OF FORTUNE (ISSN 0145-6784/USPS 52810) is published monthly by SOLDIER OF FORTUNE Magazine Inc., 5735 Arapahoe Ave., Boulder, Colorado 80303-1340. Second Class Postage Paid at Boulder, CO. POSTMASTER: Send address changes to SOLDIER OF FORTUNE, Subscription Department, P.O. Box 348, Mt. Morris, IL 61054-0348, or call 1-800-877-5207. U.S. and APO-FPO subscription rates for twelve monthly issues: \$28.00. California residents add 7.25% tax. Canada add \$10.00/yr. additional postage (includes GST tax registration number: R128476249). All other countries add \$21.00. U.S. FUNDS ONLY. Single Issue Price — U.S., \$3.95; United Kingdom, £2.60; Canada, \$4.75. PRINTED IN THE U.S.A.

CONTRIBUTORS: Manuscripts, photographs or drawings are submitted at the contributor's own risk. Material should be mailed to Articles Editor, SOLDIER OF FORTUNE, P.O. Box 693, Boulder, CO 80306, and cannot be returned unless accompanied by sufficient postage. Any material accepted is subject to such revision as is necessary to meet the editorial requirements of *SOF*. All manuscripts must be typed double-spaced. All photographs should be credited and be accurately identified. Payment will be made at rates current at time of publication. Editorial office phone number is 303-449-3750.

Copyright © 1994 by SOLDIER OF FORTUNE Magazine Inc. All Rights Reserved.

## FEATURES



Terminate With Extreme Prejudice – page 36

Photo: Paul McIver

### **HCI's True Agenda?**

#### **ELIMINATING ALL PRIVATE GUN OWNERSHIP IN AMERICA** .....

Secret internal memo outlines anti-gunners' five-year plan to rob all Americans – even police – of their 2nd Amendment right to own firearms: and not just handguns, all guns!..... 30

#### **SPECIAL FORCES INVOLVED IN WACO RAID!** ..... James L. Pate

Another example of our federal government out of control as Green Berets from 3rd SF Group collaborate in civilian law enforcement operation, in direct violation of the Posse Comitatus Act..... 34

#### **TERMINATE WITH EXTREME PREJUDICE** ..... Todd Cole

Australia's snipers undergo rigorous training and marksmanship regimen to earn the coveted "crossed rifles" badge. Though many try, few are admitted to this elite fraternity .....36

#### **JUDGMENT DAY: THE WACO TRIAL** ..... James L. Pate

Eleven Davidians are tried for murder and conspiracy in the botched Mount Carmel raid that left four feds dead. Will justice prevail over the government cover-ups and whitewashes? ..... 40

#### **SOUTH AFRICA'S BLACK HORIZON** ..... Al J. Venter

Civil war is the likely outcome of South Africa's first post-apartheid election as Zulus, Xhosas and well-armed white factions try to reconcile irreconcilable differences ..... 44



Legion Vendetta – page 62

Photo: Mark H. Milstein



**COLUMNS**



Mayhem In Mexico – page 48

Photo: Robert Walchli

**Bulletin Board** ..... 6  
Scotland Yard Scolds  
Sandinistas

**I Was There** ..... 14  
Hack Takes Up The Slack

**Combat Weaponcraft** ..... 16  
Countering Car-jackers

**Slick Willie Watch** ..... 18  
Continuing Heavy Snowjobs

**World SitRep** ..... 22

**FLAK** ..... 24  
Soviets Torpedoed *USS Scorpion*

**Advertisers Index** ..... 71

**Supply Locker** ..... 72

**Classified**..... 77

**Parting Shot** ..... 82  
Just Duel It

**MAYHEM IN MEXICO** ..... Robert Walchli  
Fueled by years of discrimination and led by professional revolutionaries, a classic peasant revolt erupts on America's doorstep. SOF chases these "Zapatistas" through Mexico's Indian country ..... 48

**FIGHTING FIRE UNDER FIRE** ..... Mark H. Milstein  
With a one-in-five chance of being gunned down in the sniper-infested streets, routine rescues become hairy salvage ops for American volunteer firefighters in Sarajevo ..... 53

**BELLY GUN INS & OUTS** ..... Peter G. Kokalis  
Powerful and accessible, half-pint wheelguns backup today's armed professional; for personal defense, nothing beats a hideable heater ..... 56

**FOREIGN LEGION VENDETTA** ..... Mark H. Milstein  
Renegade Bosnian 10th Mountain Brigade commander responsible for robbery of French Foreign legionnaires at gunpoint – pays ultimate price ..... 62

**COVER**

Aussie sniper trainee effectively uses concealment to hide from his selected target as he sights-in with issue Parker Hale Model 82 bolt-action sniper rifle mounting Kahles Helia 6x42mm scope. See what it takes to qualify as a sniper in the Australian army – page 36. Photo: Paul McIver

# BULLETIN BOARD

## DEATH CLOCK UPDATE

Heh, heh, you'll like this. Last December, when "wealthy New Jersey businessman and philanthropist" Robert Brennan paid out \$300,000 from his "Dehere Gun Fighters of America" to put up the "Death Clock" in New York City, we were told his altruistic reason for this was that his brother had been killed "by senseless gun violence." Wellll ... sort of: His brother was shot 25 years ago by a cop in New Jersey, after a car chase.

And where did this wealthy humanitarian get the piles of money for this altruistic gun grabber project? Heh, heh — it gets even better: Why, he was founder of the infamous bucket shop, First Jersey Securities. First Jersey has been under investigation by the SEC for some 15 years, and (surprise, surprise) Brennan is slated for trial as we go to press, with the SEC demanding a \$20 million disgorgement for his flogging garbage stocks on naive investors.

Wall Street columnist and author Joe Queenan suggests that perhaps Brennan should put up a "Widows and Orphans Clock" across the street from the "Death Clock" to keep a running tally of all the women and children who found out the day after the funeral that Dad's pension check was worth a lot less than expected because it consisted entirely of junk bonds.



The Heckler & Koch Offensive Handgun Weapon System (OHWS) is the subject of a Phase II contract with U.S. Special Operations Command, after competitive tests. The .45 ACP autoloading pistol is made by H&K; the laser sighting module is being developed by Insight Technology Inc.; the suppressor is being jointly developed by Knight's Armament and H&K. Photo: H&K

Or, Queenan proposes, "if Brennan has any decency at all, he might consider paying for 'The Who's-Kidding-Who Clock,' which would keep tabs on all the scoundrels who try, just before the feds haul them into court, to buy the public's favor with sordid PR stunts."

## WASHINGTON GUN MARCH

There's a movement afoot for a nationwide protest march on Washington, D.C., tentatively scheduled for Sunday, 3 July 1994, to show support for the 2nd Amendment. A million or so highly indignant (but unarmed, sober and orderly) demonstrators may have a healthy effect on legislators considering such garbage as H.R. 81 (repeal of the 2nd Amendment). For details contact Robert Johnson, 1920 Wells Road, Powell, TN 37849; phone: 615-947-9102.

## SCOTLAND YARD SCOLDS SANDINISTAS

Three years have passed since a gunman approached Enrique Bermudez in a parking lot and shot him in the head. The 59-year-old former contra leader died within minutes. Since that time there have been no arrests in the case, and few in the Nicaraguan police establishment are inter-

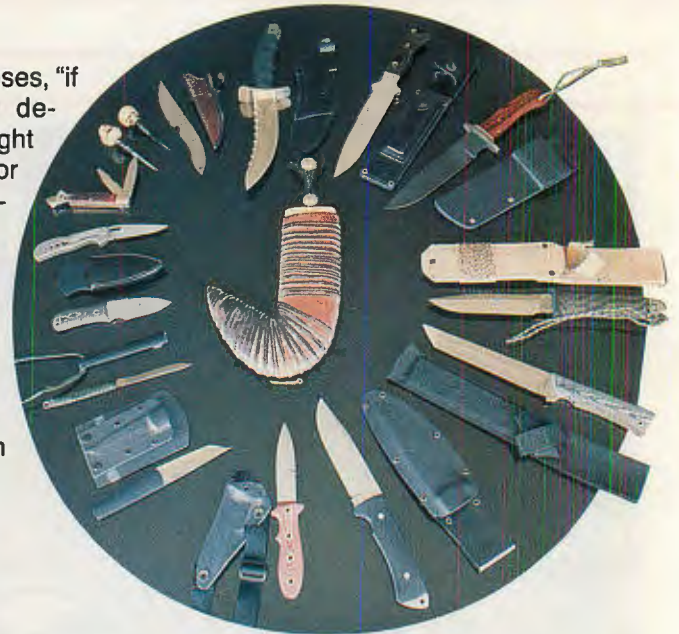

Sharp display: shown clockwise are the fine custom knives donated by their respective makers for the annual Freedom Fighters Auction at the '93 SOF convention. Starting at 12 o'clock: Al Mar Warrior, Al Mar SERE, Blade Cutlery Mod. 2, Ek SOF Ranger, J. D. Bailey Tanto, Al Polkowski custom, Tom Maringer Arabian Dagger (middle), Bud Nealy pocket Tanto, James Tukecek Neck Knife, Thomas Hermanski SEAL Boot Fighter, unidentified clip-on folder, adjustable wrench knife, Iron Butterfly, spikes with skulls, inlaid Skinner. Righteous iron, all. Proceeds went to Refugee Relief International. Our thanks to the donors. Photo: SOF staff

ested in pursuing it. Frustrated by lack of progress by the Sandinista-led police, who took a year and then handed no evidence over to the investigating judge, President Violeta Chamorro appealed to the FBI and Scotland Yard for help.

London sent detectives to Managua to review police files and make suggestions on how to pursue the case. The case still has not been investigated, and Scotland Yard's secret 33-page report has now been made public. Despite the detectives' recommendations to follow leads and reinterview several people, little, if any, action has been taken.

Top Nicaraguan prosecutor for criminal matters, Jose Antonio Fletes, stated that if Sandinistas are implicated, they probably would not be convicted: The judge handling the case, he notes, is a former agent of Sandinista state security.

## RED CELL: THE COMPLETE STORY

Get the complete inside story of the top-secret SEAL commando unit Red Cell at a special discount price! In 1985, the U.S. Navy created Red Cell and tasked it with testing security at U.S. and NATO bases. Playing the role of terrorists, Commander Richard Marcinko and ex-members of SEAL Team 6 used their special skills to carry out attacks against U.S. aircraft carriers, nuclear submarines and even Air Force One. They breached fences and gates with ease, planted bombs in sensitive areas and took hundreds of hostages, including security chiefs and base commanders. And to document these stunning lapses in security, they videotaped every mission. Red Cell: Secret SEAL "Terrorist" Operations combines this shocking footage of Red Cell operatives in action with exclusive interviews with Marcinko and ex-members of the team. Rogue Warrior II: Red Cell is Marcinko's fast-paced, chilling novel of Red Cell's clandestine operations. Bound by government restrictions, Marcinko was only able to tell a fraction of his incredible story in his blockbuster autobiography Rogue Warrior. This new novel reveals all of the secrets! The video is in color, approx. 55 min., VHS only. The hardcover book is 6 x 9, 368 pp. Order the video for \$59.95, the book for \$22.00, or receive both for just \$73.75, a 10% discount!



**FUGITIVE**  
**How to Run, Hide, and Survive**  
 by Kenn Abaygo  
 If you're serious about going on the lam, this book may just save your life. Learn to build an evasion shelter, erect path guards, lose a pack of tracking dogs, enter the "Network" of people willing to assist evaders, apply natural camouflage and utilize primitive first aid skills. This unique manual exposes you to possibilities you never even considered. 5 1/2 x 8 1/2, softcover, 96 pp. **\$12.00**

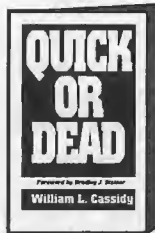

**QUICK OR DEAD**  
 by William Cassidy,  
 Foreword by Bradley J. Steiner  
 Called "one of the most important volumes ever written in the field of combat handgunning," *Quick or Dead* is a timeless history and study of combat point firing. Learn the practical, effective, realistic gunfighting techniques developed by combat vets like Fairbairn, Sykes, Applegate, Askins, Cooper and Jordan. 5 1/2 x 8 1/2, hardcover, illus., 176 pp. **\$25.00**

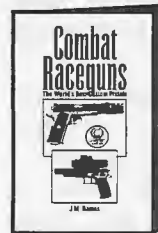

**COMBAT RACEGUNS**  
 The World's Best Custom Pistols  
 by J.M. Ramos  
 Combat raceguns - customized pistols for competition and carry - shoot faster, stay on target longer, hold more ammo and are more accurate than out-of-the-box handguns. This book will show you how to put together your own precision pistol using the best custom compensators and accessories available today. 8 1/2 x 11, softcover, photos, illus., 168 pp. **\$25.00**

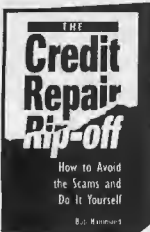

**THE CREDIT REPAIR RIP-OFF**  
 How to Avoid the Scams  
 and Do It Yourself  
 by Bob Hammond  
 Many people in financial distress have been lured by advertisements implying that bad credit can be magically erased, only to end up deeper in debt than ever. This exposé is Bob Hammond's attempt to put an end to that by revealing the truth about the credit repair scams and empowering consumers to help themselves. 5 1/2 x 8 1/2, softcover, 208 pp. **\$16.00**



**CARLOS HATHCOCK:**  
**MARINE SNIPER**  
 War Stories and Tactical Tips from the Master Sniper  
 w/ John Plaster & Carlos Hathcock  
 The most accomplished sniper of the Vietnam War and the founder of the U.S.M.C. sniper school tells in his own words how snipers outthink and outshoot their prey. In this entertaining and informative video, Hathcock talks about observation, target selection, shot placement and much more. Color, approx. 55 min., VHS only. **\$29.95**



**THE ULTIMATE SNIPER**  
 An Advanced Training Manual for Military and Police Snipers  
 by Maj. John L. Plaster, USAR (Ret.)  
 This highly readable and extremely valuable training book covers the practical, field-tested details of sniping's three great skill areas - marksmanship, fieldcraft and tactics. Rifles, scopes, ballistics, target detection, stalking, hides, camo, countersniping, special ops, police vs. military and much more. 8 1/2 x 11, softcover, photos, illus. 464 pp. **\$39.95**



**GET EVEN**  
 The Complete Book of Dirty Tricks  
 by George Hayduke  
 A hilarious overview of the methods people use to get even with big business, government and enemies. These dirty tricks range from the simple to the elaborate, including more sophisticated schemes devised by CIA and Mafia members and political dirty tricksters. For entertainment only. 5 1/2 x 8 1/2, hardcover, 208 pp. **\$19.95**



**SEAL SNIPER TRAINING PROGRAM**  
 This highly sought manual - until now available only to this elite cadre of specially trained SEALs - contains the complete program by which SEAL snipers train, equip and operate. Included are precise instructions and exclusive, clear photos for target sighting, aiming, trigger control, aircraft takedown, range estimation, helo insertion, ship boarding, stalking, marksmanship and more. 8 1/2 x 11, softcover, photos, illus. 320 pp. **\$30.00**



**AMERICAN SWORDS AND SWORD MAKERS**  
 by Richard Bezdek  
 This is the first book ever to span the complete history of American swords, sword makers and sword dealers from Colonial times to the present. More than 200 exquisite photos of important cavalry, infantry, artillery and naval swords and the most complete bibliography in print on swords and sword makers make this the definitive volume for collectors and historians. 8 1/2 x 11, hardcover, photos, illus., 664 pp. **\$79.95**



**ULTIMATE SNIPER: THE VIDEO**  
 w/ John Plaster & Carlos Hathcock  
 Learn the art of sniping from two masters. Maj. John Plaster instructs you in all areas of sniping fieldcraft, marksmanship and tactics, and famed USMC sniper Carlos Hathcock recounts some of the field-tested tactics he used to rack up 93 confirmed kills in Vietnam. Covers optics, weapons, shooting drills, camo, stalking, hides, countersniping, range and wind estimation and more. Color, approx. 90 min., VHS only. **\$59.95**

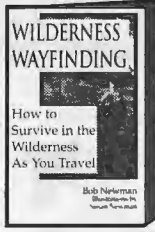

**WILDERNESS WAYFINDING**  
 How to Survive in the Wilderness As You Travel  
 by Bob Newman  
 The first truly complete easy-to-follow guide to finding your way in the forest, mountains, desert or any wild environment. Let a pro teach you about maps and compasses, land navigation, building emergency shelter, finding food and water, forecasting weather, administering first aid and much more. 5 1/2 x 8 1/2, softcover, photos, illus., 160 pp. **\$15.00**

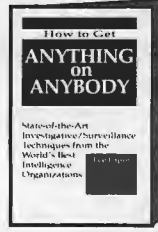

**HOW TO GET ANYTHING ON ANYBODY**  
 by Lee Lapin  
 Get the goods on others with this encyclopedia of advanced investigative and surveillance techniques. Here are expert ways to secretly bug any target! Info on lock-pick technology, how polygraphs and voice lie detectors can be tricked and much more, including more than 100 sources for spy equipment. 8 1/2 x 11, softcover, illus., 272 pp. **\$30.00**

### OTHER FASCINATING TITLES

**PRIVACY: HOW TO GET IT.**  
 HOW TO ENJOY IT.....\$18.95  
 HOW TO BECOME A  
 MASTER HANDGUNNER.....\$10.00  
**SEAL COMBAT**  
 BOARDING MANUAL.....\$20.00  
**U.S. NAVY SEAL**  
 COMBAT MANUAL.....\$19.95  
**GET EVEN 2: MORE DIRTY**  
 TRICKS FROM THE MASTER  
 OF REVENGE.....\$19.95  
**HANDGUN STOPPING POWER:**  
 THE DEFINITIVE STUDY.....\$39.95  
**MAKING YOUR AR-15**  
 INTO A LEGAL PISTOL.....\$14.00

**AK47: THE COMPLETE**  
**KALASHNIKOV FAMILY**  
 OF ASSAULT RIFLES.....\$14.00  
**AMBUSH! NAVY SEALs IN**  
**DEADLY ACTION (VIDEO)....\$29.95**  
**HANDGUN MUZZLE FLASH TESTS:**  
 HOW POLICE  
 CARTRIDGES COMPARE.....\$20.00  
**INSTINCT COMBAT**  
 SHOOTING.....\$12.00  
**RIGHTEOUS REVENGE.....\$19.95**  
**CREDIT SECRETS: HOW TO**  
 ERASE BAD CREDIT.....\$14.00  
**JUST SAY NO**  
 TO DRUG TESTS.....\$12.00

**MONEY-BACK GUARANTEE — DEALER INQUIRIES INVITED**  
 Paladin Press • P.O. Box 1307 • Boulder, CO 80306 • (303)443-7250  
 FAX (303)442-8741

Videotapes are nonreturnable. Damaged tapes will be replaced.



**PALADIN PRESS**  
 P.O. BOX 1307-4ES  
 BOULDER, CO 80306



**CREDIT CARD ORDERS CALL TOLL FREE**  
 1-800-835-2246, ext. 21  
 Call 24 hours a day, 7 days a week. Send \$2.00 for a  
 56-page CATALOG of over 500 titles (free with order).

PLEASE SEND ME THE FOLLOWING TITLES:

RESPONSE CODE: 4ES

\_\_\_\_\_  
 \_\_\_\_\_  
 \_\_\_\_\_  
 \_\_\_\_\_

VISA  MASTERCARD  
 DISCOVER  CHECK / MONEY ORDER  
 CARD# \_\_\_\_\_  
 EXP. \_\_\_\_\_

NAME \_\_\_\_\_  
 ADDRESS \_\_\_\_\_  
 CITY \_\_\_\_\_  
 STATE \_\_\_\_\_ ZIP \_\_\_\_\_

SUBTOTAL \_\_\_\_\_  
 PLEASE INCLUDE  
 POSTAGE & HANDLING \$ 4.00  
**TOTAL** \_\_\_\_\_



## SPEAKING OF JUSTICE...

John Lawmaster of Tulsa, Oklahoma, has filed suit against ATF agents who trashed his home (see "Gun Gestapo" *SOF* June '92). The 10th U.S. Circuit Court of Appeals in Denver refused a request by Lawmaster's attorney to unseal the affidavit used to obtain a search warrant of Lawmaster's home. The affidavit wrongly accused Lawmaster of possessing an illegal machine gun; the U.S. Supreme Court refused to hear an appeal of the 10th Circuit's refusal.

According to Lawmaster's attorney Steve Sessinghaus, suit has now been filed against agent P. Blair Ward of the ATF's Tulsa office, who led the raid, and other goons involved. Like Davy Aguilera, ATF's case agent in the monumentally disastrous Waco raid, Ward has been characterized as having graduated from the Idi Amin Academy of Police Procedure (see "Miscarriage of Justice" *SOF* April '94).

The suit alleges that Ward's wanton recklessness violated Lawmaster's 4th Amendment right

to reasonable search and seizure, and his 5th Amendment right to due process. The suit seeks more than \$50,000 in compensatory and punitive damages. A jury trial has been demanded. We wish him well.

— James L. Pate

## ACTION TO SAVE SOUTH AFRICA

As of this writing (February 22, 1994) — a bit over two months before the election scheduled in South Africa on April 27 — intertribal violence and terrorism, especially in the black townships, are totally out of control and are taking on the nature of a civil war. On one side are the South African Communist Party (SACP); the African National Congress (ANC), led by the Mandelas; and the even more violently radical Pan Africanist Congress (PAC). On the other side are the multiracial Freedom Party, the Volksfront (mostly white Afrikaners) and the predominantly Zulu Inkatha Freedom Party (IFP). Not a tenth of the murders are reported in the media, even inside South Africa. Almost all of

the victims are blacks, either Zulus or members of other tribes refusing to submit to SACP/ANC/PAC dominance. The killing of whites comes later.

The Freedom Party, the Volksfront and the IFP are refusing to take part in the April 27 elections. "We can recognize a trap when we see it."

Finally, the Zulus are organizing and training Self Protection Units. They are desperately short in such basic things as boots, uniforms, web equipment and, especially, medical supplies. The cost of shipping these items makes donations in kind impractical, and most of them can be bought inside South Africa, were it not for a desperate shortage of funds available to the Freedom Alliance.

Checks should be sent to: ACTSA (Action to Save South Africa), P.O. Box 226, Auckland Park 20006, Johannesburg, South Africa. Donations are not, of course, tax deductible, but for that reason all the more appreciated.

Continued on page 13

# EXTRAORDINARY SURVEILLANCE AND INVESTIGATION AIDS

## SURREPTITIOUS SUPPLIES?

**Surveillance, counter surveillance, audio surveillance, video surveillance, people trackers, covert entry equipment, night vision, cellular interception, untraceable phone calls, electronic trackers, the world's smallest video cameras and transmitters, encryption, scramblers, and devices to defeat both, aerial photos of anyplace, the MASTER list of information suppliers, specialized newsletters, OEM lock picks, thru wall listeners, reverse engineers, Spy Shops, alternate IDs, non-lethal weapons, program crackers, and much more.**

**SAVE HUNDREDS, EVEN THOUSANDS OF DOLLARS!** Order directly from the original sources. For the first time Lea Lapin, author of *How To Get Anything On Anybody*, publishes his private list of suppliers from the world over. Locate impossible equipment—shop where the smart guys shop. **THE COVERT CATALOG** provides hundreds of addresses, sample pages, catalog prices and recommendations that will save you money on everything from break-in books to undetectable bugs. The latest and the best. Designed for PIs, cops, security folk and those with a need to know...

**THE COVERT CATALOG**, \$34.95. Hell, you'd spend that much on postage alone...

## OPEN ANYTHING

**II KILLER KITS WHY OVER BUY? NOBODY NEEDS 100 PICKS...**

**Kit A** features 16 hand finished steel spring picks, assorted tension tools and extractors plus a collapsible CAR DOOR OPENER that

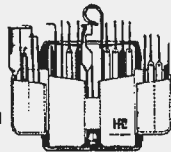

assembles into a Slim Jim or Peg Leg style car popper, all in a shirt pocket sized real leather case; PLUS 6 Super Shims that click open virtually any spring live latch bolt in a few seconds... Special Introductory price \$109.50!

**Kit B** Everything in Kit A, plus a Lockaid Pickgun specifically designed for locksmiths and law enforcement agencies to quick pick pin tumbler locks. \$164.95. Gun alone \$59.95.



**Kit C** Computer designed rocker picks that open many locks when regular picks won't. Hand finished stainless steel in a clear case. \$79.95

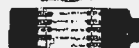

**COBRA III+** Electronic Lock pick. We've sold them all and now we only sell the one that really works. Designed by the inventor of electronic lock picking the Cobra III+ features a more powerful motor, replaceable/rechargeable hot packs, Halogen light to illuminate the key way, rubber grips and improved picks. Opens 99% of all locks in seconds. \$399.00



**PURCHASE ANY OF THE ABOVE AND GET OUR INSTRUCTIONAL VIDEO SUPERPICKING FOR ONLY \$24.95!!**

\*Note you must be over 21 and in law enforcement, licensed security guard or student locksmith to purchase lock opening devices. By ordering any of these devices you are so stipulating to the above conditions.

## SURVEILLANCE / COUNTER SURVEILLANCE

**Automatic Tap Stopper** Just designed, first time on the market, this state of the art unit stops most phone tap attacks in their tracks. Beats/defeats

drop-out relays, auto recorder starters, VOX recorders, Infinity transmitters, X-phones, room mics (on phone lines) hot hook switches, auto transmitters and most free running transmitters! More Bang for your buck! The ATS will flat out prevent almost every possible telephone tap or room audio (via the phone or phone line) bug, does not interfere with normal calling. **If you value your privacy you need the ATS! \$495.**



## MASTER Z TOOL SET

94 Master Z Tool Set opens over 700 cars with ease. Beats any door cavity locking system and most power lock door switches. Easier to learn, easier to use than those sloppy sets that feature 50 bent wires and a prayer. Never be locked out of your car again. Includes Z tool with depth guides, new system manual, Japanese tool, Autobuster II tool, 2 Flex wedges and a carrying case. \$109.95

## VIDEOS

### PEOPLE TRACKING

You Can Find Anyone. The definitive work on locating old friends, skippers, heirs, bad guys, good guys. How to info plus sources and short cuts for both beginners and pro's. \$69.95

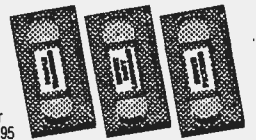

**SUPERPICKING** The California lock picking champion along with the inventor of the electronic lock pick show exactly how to pick, rake, spring and generally open pin tumblers, discs, car locks and, well, almost any lock. \$59.95. OR JUST \$24.95 with the purchase of either Killer Pick Set or Cobra III+!

**SEND CHECK OR MONEY ORDER TO:**  
**INTELLIGENCE INCORPORATED**  
**2228 S EL CAMINO, #349 A**  
**SAN MATEO, CA 94403**

Include \$5 shipping. CA residents must include 8% tax.

**ORDERS ONLY:**  
**1-800-805-5544**

(Nice order takers but they have no other information available.)

**CATALOG \$5.**

Visa and Mastercard accepted

**INTELLIGENCE INCORPORATED**

And the amazing thing is, you can learn it in one day!

# Secret New Fighting System Will Make Even A Black Belt Karate Master Putty In Your Hands!

If You Are Even Remotely Interested In Learning How To Physically Protect Yourself (and your loved ones) *With Complete Confidence*, Then This Will Be The Most Important Letter You Ever Read.

Very few people will ever be allowed to see the material presented here – I am being almost ridiculously selective because of the incredibly *dangerous potential* of the information revealed.

– by: Leo Costa, Jr. –

Dear Friend,

**Here is why:** I have recently discovered a “scientific” fighting system that is so effective, you will be able to *knock senseless* anyone who confronts you – no matter how skilled they are at fighting – within **1 or 2 seconds!** What’s more, this fighting system is so easy to learn, you will be able to *master* it completely, even if you have never been in a fight before in your life, or are a “klutz” at physical skills. Kids, women, even grandparents can master this system with equal ease – and be able to instantly “put away” any bully or criminal who comes after them.

This system is called **Hostile Control Systems** (or “HCS” for short). I’ve seen it in action, I’ve used it, and I tell you with all seriousness that it is simply...

## The Most Devastating Fighting System Imaginable – Yet It’s Like Nothing You’ve Seen Before!

In most cases, you’ll be able to end a fight instantly with a *single move* (that *cannot be defended against!*) no matter how “overmatched” you are in size or meanness. You do not need quick reflexes, big muscles, flexibility, or any previous fighting skills at all. Nor do you need hours of practice, because you can learn *everything* – on your own – in just a short time. And since this amazing new system is based on the way you move *naturally*, once you see how HCS works, you’ll know instinctively how to use it **forever!**

I know you’re probably skeptical right now – I certainly was at first. But let me tell you, everyone who has seen HCS in action has finally admitted that it is, ultimately, the only *truly undefeatable fighting system* ever developed. And I’m talking about people who have a lot to

lose by admitting this... for example:

\* One man, who is a U.S. military combat instructor with 3 black belts in different martial arts, was so convinced after just one month of using and teaching the “military” version of this fighting system that...

### He Ceremoniously Burned All 3 Of His Black Belts, Saying He’d Finally Found The Undefeatable Fighting System He’d Been Searching For All His Life!

\* A dentist, who was also a trained marksman, actually held an unloaded gun to my head and dared me to “get out of this situation with your fancy HCS”... and was astounded *one second later* to find himself disarmed and helpless! Yet I had *never practiced even once* the simple move I used – it just came “naturally” to me via my recent HCS knowledge!

\* My friend Russ, who is a skilled kick-boxer (and a bodybuilder weighing 230), taught his 130 lb. non-athletic wife just one HCS move, *one time*, and then tried to surprise her with a strangle hold – she reacted without thinking, nearly dislocating Russ’s thumb and putting him on the floor so easily that it actually frightened him!

\* We had a well-known local Kung Fu instructor stop by, and he *refused* to even go up against an opponent using HCS once he saw it in action – he could instantly tell he would be helpless to defend himself, or to even get a strike in before he went down!

I could go on for pages with more examples. But here’s the “clincher”: My friend Bob (6’4”, 240 lbs. and ripped) and I both tried to “get” at a guy using HCS

who maybe weighed 150 lbs. soaking wet. It was only a demonstration, but I wasn’t holding back. Now, I weighed in at about 250 myself, and I was fresh from a recent first-place finish at a California bodybuilding show... between the two of us, this little guy should have been beaten *easily*. Yet, he dropped Bob to his knees with a little “tap” to the ribs... and I’m *still* hurting (weeks later) where I got “gently” popped. We never touched him. If it had been a real fight, the squirt said he wouldn’t have been so easy on us.

### Two Moves, The “Fight” Was Over... And We Wanted No More Of That Little Guy!

It was the most amazing demonstration I’d ever experienced. And once *you* see HCS in action yourself, I’m sure you’ll be just as amazed. Here is how we came to discover HCS:

A few months ago, I was introduced to some members of the Navy SEALs, who are the “elite of the elite” of our military’s Special Forces – the guys trained to go on the most dangerous missions, to overcome the most impossible odds, and to...

### Never Lose A Fight!

Yet they use no martial arts or other “classic” fighting methods whatsoever. In fact, for the last 5 years, the SEALs have been using a special fighting system – it’s called “SCARS”, and it was developed by an ex-U.S. Army soldier with the reputation of being the most dangerous hand-to-hand combat man in the world.

The SEALs began using SCARS because they needed a fighting system that would allow them to quickly (within one or two seconds) defeat *every* enemy

they encountered, under the worst conditions imaginable: This new system would have to work even if they were exhausted, starved (their missions often had them covering hundreds of miles on foot with no food or water for days), *wounded*, carrying 80 lb. packs, and operating in ridiculously cramped spaces (such as the hallways of a submarine). And here's the kicker: It had to work *100% of the time*, no matter what.

### **If This New System Didn't Work, Good Men Would Die!**

They were simply amazed with what they found. SCARS exceeded their wildest dreams – **in over 5 years, the SEALS trained in SCARS have never been defeated in a single hand-to-hand fight!** The SCARS system has been tested *in the field* over and over again, under the most nightmarish real-life combat conditions...

### **And It Has Never Failed!**

Man, this was something I wanted to find out more about... but I couldn't. No civilian could ever learn the secrets of the SCARS system – it was strictly classified information. But I *could*, if I had the guts, meet the man who put the SCARS system together – that ex-soldier who had re-invented hand-to-hand combat from the ground up. (He's the first civilian ever contracted by the U.S. Navy to train SEALS in all aspects of combat fighting... and his SCARS system has been taught to more SEALS than any other fighting system!)

That's how I met **Jerry Peterson**. Let me tell about this guy (it's a Hollywood story in itself): He was a "front line, front line" combat soldier in Viet Nam – in the thick of the most vicious jungle fighting of the war. He stayed for two tours, and the killing he experienced made movies like "Platoon" and "Rambo" look like picnics in the park. He was a star point-man in "Charlie Company" (the 173rd Airborne), which was the most-decorated outfit in the military for that war, and which saw *more action* than any other group of soldiers... including the Green Beret.

### **Jerry Was Able To Study The "Science" Of Hand-To-Hand Combat In A Personal Way Most Men Cannot Conceive Of!**

And he learned some very interesting things – first of all, he learned quickly that the martial arts training he'd been given in boot camp was practically *worthless* in the field. Even the fighting styles of elite special forces (like the vicious Korean "Rock" units) were too fancy for the in-tight killing that occurred on the front lines.

So Jerry began to pick and choose among the various fighting styles he'd been exposed to: the street fighting of his youth, the most effective strikes from the martial arts he'd mastered as a soldier, the killer moves he saw from the Vietnamese, and the tips he learned from other grunts who had survived and *succeeded* during those long, bloody days in the field.

By the time he left the army, Jerry had developed a tested, *scientific* method of "analyzing" fighting skills. He was a "fighter's fighter", and was only interested in the parts of other fighting systems that met the strict, basic principles that he *knew* worked in the real world. He examined the psychology, the physics, and the human geometry of **sport fighting** (American boxing, wrestling, kick boxing, etc.), **street fighting** (both "consensual" barroom brawling and criminal attacks), and the "**fight or die**" combat of wartime. He analyzed the best Asian fighters in the world, from China, Japan, Korea and the Philippines... and he dissected the Europeans (where the ancient fighting systems of the Celts, the Swedes and the French are still employed with great success). For 20 years he studied, becoming, quite literally...

### **The Most Dangerous Man In The World At Hand-To-Hand Combat!**

And what he learned in those 20 years confirmed my own nagging suspicions: He saw men and kids all over the world being confused by so-called "experts" who had no real-life experience in fighting. Jerry decided that was wrong, and he began to form his *own* method of fighting. But it wasn't like so many other "new" systems out there, which are a hodge-podge of "maybe's". No. What Jerry was able to put together, based on his 20 years of strict scientific analysis, was a system that took advantage of the *universal secrets* of the best-of-the-best fighting systems – for the first time, the most super-effective psychological, physical, and human geometrical *truths* of fighting were "melted down" and...

### **Distilled Into A Basic, Simple, And Deadly System That Could Be Learned And Used With Ease By Anyone!**

That's when the SEALS found Jerry, and convinced him to develop the system they so desperately needed. (By the way, Jerry has also taught fighting systems to police department SWAT teams.)

Let me tell you, despite his brutal background, Jerry is one of the most *concerned* men I've ever met. He's seen firsthand how bad guys take advantage

of decent men and women and children, and he seriously does not like it. He *hates* the idea of his kids, or anyone else's kids, having to walk in *fear* in their own community – and it wasn't difficult to talk him into creating a new system of fighting for civilians. One that we could bring to people like you, to people like my family and friends. A system that would work with...

### **100% Effectiveness, 100% Of The Time!**

Here's what you get in the Hostile Control Systems package that Jerry has put together for you:

1. Two full-length video tapes, featuring Jerry himself and two actual **combat instructors** from the SCARS organization, that show you everything you need to know about this new system. The tapes use live action footage, multiple camera angles, and slow motion replays – so each tape is a complete lesson.
2. A special report on Street Fighting that gives you an *inside look* at what really happens in most altercations, whether it's in a beerhall, a back alley, a busy street, or a fancy restaurant. You'll come away with a lifetime worth of "street" knowledge and savvy – and you'll *never* be surprised by what happens to you in the real world again!
3. You get a heavy manual full of illustrations and detailed explanations of everything you'll see in the videos.
4. *Plus*, you get a detailed human anatomy chart, inside that manual, illustrating all the "one-strike take-down points" you'll use as targets – along with explanations of what happens when you strike each target!

This last part is very important, and it's what sets HCS apart from any other fighting system on the planet. The reactions a human being exhibits after being hit are 100% predictable – it's called **autonomics**. That's a fancy word that simply means "the automatic reactions" of human movement. Here are a few examples of what you'll learn:

- You can easily force a man into the same violent (and involuntary) reaction *every time* simply by "targeting" his solar plexus... and he'll go down into the exact floor-space you want him to! (By the way, his solar plexus is already "pin-pointed" for you by a button on his shirt!)
- A stomp on his *shoelaces* (with no more force than crushing a bug) will produce a "two-pronged" autonomic reaction that leaves him helpless and "set up" for a simple fight-ending move your grandmother could deliver.
- There are 2 "secret" ways to instantly manipulate a man with kidney punches,

both of which allow you to *end* the fight with your next decision... in your own sweet time. (It's easy to target the kidney once you understand the simple "map" of target areas we give you.)

- Forget what you see in the movies – the autonomic reaction to a groin kick is identical for every man, every time. And your *second* kick also produces a 100% predictable response (which, if you don't step clear, might soil your shoes). Even more important, he will be left helplessly open to a devastating "tap" from you that will end his fighting days for quite awhile.

I could go on for pages, but you get the idea. This "science" of autonomic reactions comes from Jerry's 20 years of studying hand-to-hand combat *in person*. Soldiers who study with Jerry often have to put what they've learned to the test *immediately*... and they come back with detailed results of the effects.

### **These Fighters Know – With As Much Certainty As A Pool Player Knows Where The Cue Ball Is Headed – What To Expect When They Deliver A Strike!**

The importance of this knowledge becomes brutally obvious when you see your standard downtown martial art studio in action. People are taught to deliver strikes up and down the body in rapid succession – face, neck, solar plexus, groin, knee, et cetera. Yet these multiple moves can almost never be used in a real-life situation... because the first strike will cause autonomic reactions that make the *next* strike *physically impossible*! Even more important...

### **Why Do You Need To Practice Multiple Strikes When Real Fighters End A Fight In 1 or 2 Seconds With One Blow!**

Black belt instructors who aren't real-life fighters simply do not have the knowledge to predict a man's physical reactions to being hit. And this creates a "mystery zone" for their students... if you can't predict how a person will react to your strikes, how can you know what to do next? I think that's ridiculous.

### **With The "Real Life" Fighting Know-how You Get From HCS, You'll Always Know What Happens Next!**

There will be no "gray areas" in your knowledge. No guessing. Not even a *shred* of self-doubt! If you ever have to use what you've learned, you will have the confidence of knowing what to expect at *each and every moment* – from the first

push or insult to the moment *you* decide to end the confrontation. I can't stress how crucial that is in the real world. It's the difference between standing there blinking and being a *victim*...

### **And Walking Away As The Victor!**

Here's what *else* you're going to learn:

- How a single "secret" statement can *end* a fight in your favor before it begins!
- How to instantly "take down" aggressors even if they surprise you!
- How to identify the basic "tough guy" gestures nearly all attackers make just *before* they deliver their first blow... split seconds before they realize they're about to act themselves! (Giving you time to *end* the situation before it actually starts!) For example:
  - A man will move his chin in a predictable way just before striking...
  - His eyes *will change* when he's reached the boiling point...
  - And you should know what's coming next when he *steps back 2 paces* or has just put his hand on your shoulder (it ain't a goodbye kiss that he's got in mind!)
- How to conquer forever the "shakes" and out-of-control anger or fear that all inexperienced fighters suffer!
- How to do ultimate damage to your targets... *without hurting your hand!*
- How to mentally *force* your attacker to open himself up to your easiest single-strike take-down moves!
- The secrets of using pain and shock to disable your opponent without causing him permanent injury.
- How to "skip" the one unforgivable mistake almost *every* inexperienced fighter makes instinctively! (Which usually gets them hurt badly!)
- Why you *never* need to use defensive blocks... and why it's a dangerous waste of time to even learn them!
- The *single most important question* you must ask yourself – and answer – in any difficult situation!
- Your body's 12 most devastating natural weapons (including your own "personal piece of steel pipe"!)
- Your best 6 "*first strikes*" (guaranteed to drop your assailant instantly)... from a seated position, standing face-to-face, when attacked from behind, when attacked by a larger aggressor (ideal for women and kids), and more!
- How to easily turn your day-to-day attitude into an "Offensive Mindset" that won't change anything about you except:
  - Your level of fear will *vanish* forever...
  - You'll become more decisive in *everything* you do, and especially when the chips are down...
  - You'll gain **enormous self-confidence** that will shine like a

searchlight in your eyes...

– You will take total and complete *control* of every situation in your life – instead of just reacting to what happens to you (like a helpless puppet whose strings are pulled by other people!).

- How to understand the "Hierarchy of Critical Decisions" that occur in every conflict. (This is a revelation to anyone who hasn't experienced a lot of fighting – with this knowledge, you can pinpoint the *exact moments* you must choose your next action... so you are always in control, always one step ahead of the other guy!)

And more, and more, and more. This package is truly the most amazing self-teaching method of real-life fighting you've ever seen. Just listen to what some very impressive people have to say about Jerry's fighting systems:

*"A mere two weeks ago I was forced into a violent confrontation with an ex-felon street gangster thug. Thanks to HCS, I won - He went back to jail and I went about my business."* James McEvoy, Phoenix, AZ

*"What really convinced me – and I've used this stuff in real fights – was the abundance of options available. I could control, scare, hurt, debilitate... it was up to me, not the other guy. Your only choice to make is: What damage do I want to do to this person? You never need to wonder: What's gonna happen next?"* Tim (Last name withheld due to security regulations), combat instructor for the SCARS Spec. Warfare Division.

*"I was skeptical of your program at first. Since training with HCS just a few weeks, I must agree the program is 'ultimate self defense'. I would like to thank you in advance for saving my life."* Steven Blackmon, Concord CA

*"I earned a first-degree black belt while training in Japan in what I thought was the most effective martial art in the world... but after seeing how fast the methods used in Hostile Control Systems can eat up even an experienced fighter like myself, I'm convinced this new system is the way to go."* Kelly Dyinge, Instructor/Owner Full Force Kickboxing

*"...I have to say that (HCS) is the most practical and realistic system around today. I always wondered how the special forces soldiers could learn practical fighting in a short period of time. If this catches on, it could put some Martial Arts schools out of business."* Mark Bratsch, Keansburg NJ

Let me stress something here – **you need this information!** It is not a luxury, not in today's world. I just saw some

video tape on T.V. of convicts in prison... you know what they were doing during their "free time" in the prison yard? Teaching each other how to sneak up and rob people, how to choke and drag off victims without sound, how to hurt and cripple and *destroy people's lives* just to satisfy their sick needs. In short, they were "going to school" to learn how to take advantage of you once they get out!

Do you want to be a victim? Do you want your loved ones to be victims? Do you want to walk around with a layer of sweaty fear on your skin all the time, knowing you're vulnerable at every street corner to being assaulted, robbed, or worse? I sure don't, and I don't believe you do, either. It's time to learn how to take care of yourself.

This information does not insult your intelligence in any way – there are no mysterious Oriental chants or religious nonsense to learn. You do your learning at your own pace, at home. You can learn *fast*, too...

**In A Matter Of Hours You'll Surpass The Fighting Skill Of Guys With 10 Years Experience In Martial Arts!**

That's because this stuff is based on **what works in real-life fights** that take place in one or two seconds. You need no previous experience in any kind of fighting whatsoever – we'll show you *everything* you'll ever need to know. You don't need

to be strong, quick, agile, or even in shape. And every move is base on the way you move *naturally* – there's no gymnastics involved, no spinning kicks, no jumping, no fancy moves of any kind.

Though let us be clear on this: **You must take total responsibility for your actions** – this is a "use at your own risk" type of product, and you can understand why I have to say that. What we're teaching here is the most effective fighting method on the planet... used correctly, and you will be able to defeat anyone – unless they happen to be a Navy SEAL. But we can't make you invulnerable to the world – this is your best-possible defense against aggression, but it's not fool-proof. Just so long as we understand what's going on here, all right?

I'm **not** asking you to take any financial risk. I'm going to make it as simple as possible for you to try this amazing Hostile Control Systems out for yourself... without risking a dime. Here is my

**100% No-Nonsense Guarantee:**

If you aren't convinced that this system is everything I've said it is... a no-guess work, tested in real battle conditions, easy-to-learn *fast* course in turning yourself into the most formidable fighter you could ever dream of being... after *trying it out* for 3 entire months, then I insist you return the package to me, and

I will immediately send you a 100% refund of your purchase price. No questions asked, no hard time from me... and we'll still be friends. I trust your opinion, and I believe you won't take advantage of me on this "almost too-generous" guarantee.

That's a darn good, no-risk-on-your-part guarantee. And it means, simply, that there isn't any reason in the world for you not to try this incredible fighting system out for yourself. Within those 3 months, you're going to acquire confidence like you never imagined possible before... and you're going to learn fighting skills and know-how that will place you in the *upper 2% of the world*... including all those guys who have been slaving away at their martial art for 5 and 10 years.

**So How Much Does This HCS Package Cost?**

Not very bloody much. At first we thought of making it a very "elite" course, available only to a few people who could afford a very steep price tag. But that didn't sit right with me – I wanted to get this information out to *everyone* who deserves to get it.

So, we finally came up with a price that is fair to everyone. The cost to you for this whole package – the 2 video tapes, the manual, the special report – is just \$69 plus \$5 for shipping and handling. (Total \$74) **IT'S EASY TO ORDER:** Call our toll-free phone number – **1-800-582-2083**, ask for dept. 47-H – and use your credit card. Or, if you prefer, you can fill out the Priority Order Form, and mail it with your check or money order. We'll ship your package out first-class just as soon as we receive your order.

That's all there is to it. You have my *personal guarantee* your package will live up to your expectations... or you get your money back. This is the real thing, too – it's changed my life, and the lives of my loved ones. It's a confidence-booster, and the best way I've ever experienced to put you in control of your life 100%. So call right now... you never know when you're going to need the know-how and skills you're about to learn!

Sincerely,

*Leo Costa Jr.*

Leo Costa, Jr.

P.S. I almost forgot something important. We've only put together a small number of these HCS packages, so you really need to call *today* to make sure you get one reserved for you. It's a great deal, but there may not be enough packages to go around without delays. Just give us a call at **1-800-582-2083**, and make sure you get *your* package now. Thanks.

**Priority Order Form For Soldier of Fortune Readers Only!**

*For The Fastest Delivery, Use Your Credit Card And Call Toll-FREE*

**1-800-582-2083 (Ask For Dept. 47-H)**

**YES!** I'm finally ready to take responsibility for protecting myself and my loved ones, and I can see that this amazing Hostile Control Systems video package can quickly give me the devastating knowledge and skills I need! I understand that I can try out this package for a full 3 months, at my own pace, and if I'm not satisfied – for any reason, or for no reason – then I can return it for a complete, prompt and 100% refund of my purchase price. It's a great deal, with no financial risk on my part whatsoever; thanks, Leo!

By initialing this line, I am stating that I am over 18 years of age and that I have never been convicted of a felony. I also state that I will use the information contained in Hostile Control Systems in a defensive situation only. I accept sole responsibility for my actions as an adult.

Name: \_\_\_\_\_

Address: \_\_\_\_\_

City: \_\_\_\_\_ State: \_\_\_\_\_ Zip: \_\_\_\_\_

My check or money order in the amount of \$74 is enclosed.

Bill my:  Visa  MC  Amex  Disc Card #:

Exp. Date: \_\_\_\_\_ Signature: \_\_\_\_\_

Foreign orders must pay additional shipping & handling. Call 1-209-732-5378 for details. (CA orders add \$5 sales tax.) Rush shipment available for extra fee.

**Optimum Training Systems**  
2945 S. Mooney Blvd., Dept. 47-H  
Visalia, CA 93277

Continued from page 8

### AIR COMMANDOS TO MEET

The 50th anniversary reunion of all Air Commandos (World War II, Vietnam, Grenada, Panama and Desert Storm) will be held at Hurlburt Field, Florida 7-9 October 1994. For update info, call or write: Air Commando Association, 25 Miracle Strip Parkway SE, Fort Walton Beach, FL 32548; phone: 904-243-4601; fax: 904-243-3568.

### COME ON IN

If you were ever a contract agent in covert activities for a U.S. intelligence agency, you may be missing Social Security credit for your years of service. For free information on how to proceed, send a self-addressed, stamped envelope to: Pensions, c/o IDEVCO, 113 West Houghton Ave., Houghton, MI 49931. Strict confidentiality respected.

### ONE MORE "ASSAULT GUN"

In SOF's recent tabulation of "assault guns" we missed one: the Patriot .223 pistol manufactured by

Winners of the SOF '93 18th Anniversary Sweepstakes were:  
—Grand Prize: Robert P. Johnson of Powell, Tennessee (choice of South African safari or trip to SOF Convention).

—Second Prize: Joseph Konchalski of Monroe, Georgia (Ruger Mini-14 rifle).

—Third Prize: Robert Todd of Kenner, Louisiana (Al Mar Knife).

—Fourth Prize: Kenton Faith of Calvert City, Kentucky (Al Mar knife).

—Fifth Prize: Jason Casselman of Ontario, Canada (Al Mar knife).



Rocky Mountain Arms (Box 329, Longmont, CO 80502).

### CONGRATS, WINNERS!

Winner of the SOF July '93 promotional sweepstakes was Richard Woehrel of Bridgewater, New Jersey, who won a Ruger .45 KP90DC pistol.

### NKP THAILAND

General Harry C. Aderholt (USAF-Ret) is trying to locate Colonel Joe Price and Zorro pilots at NKP, Thailand in 1966-1967. If you have any information please phone: 904-243-0442; fax: 904-243-3568. ✉

# ONCE IN A LIFETIME OPPORTUNITY!

The **NEW IMPROVED** Poor Man's

**BUY IT BEFORE IT'S BANNED!**

*THE POOR MAN'S JAMES BOND*

WE SHALL FIGHT IN THE STREETS

MADE BY ELECTRONICS

U.S. MEMBERSHIP

MADE TOWARD COMBAT

*The New Improved*

## The Poor Man's JAMES BOND

Now you can own THE POOR MAN'S JAMES BOND! By special arrangement with the author, we have printed only 4000 copies! Just reviewed by the FOX network! The most infamous book ever written! NOW available for about 50% of what competitors offer it for! **Only \$12.00! Regular \$22.00!** For the public only, 477 pages of the most valuable information a patriot/anarchist could ever desire!

**Not \$22.00 ONLY \$12.00**

24 Hour Order Line 318-688-1365 FAX 318-688-1367

**N.I.C. INC.** 500 Flournoy Lucas, PO Box 5950-JF Shreveport, LA 71135-5950

Order #B450 \$12.00 plus \$3.00 per book P&H

Name \_\_\_\_\_

Address \_\_\_\_\_

City/State/Zip \_\_\_\_\_

Card# \_\_\_\_\_ Exp \_\_\_\_\_

VISA  MC  M/O  CHECK

**SAME DAY SHIPMENT!**

# I WAS THERE

by Jerry Sullivan

*January 1969 ... along the Cambodian border in the Mekong Delta ...*

The Special Forces camp at Muc Hoa could have been a set for the bar scene in *Star Wars*. All kinds of bizarre characters hung around, most armed to the teeth, with thousand-yard stares. Over the years the Army had acquired some dangerous indigenous hired hands. Relations between them and our Hoi Chan Tiger Scouts bordered on open warfare.

We'd been airlifted into the remote camp to meet our new boss. Little apparent rhyme or reason existed for what the 4th of the 39th, 9th Infantry did. Much of the time we did nothing other than take casualties to booby traps and the occasional sniper.

Morale was low and many troopers were high. Not what I'd expected and certainly not what I wanted. I was regular Army (*yeah, yeah, I know, hold the applause until the end, please*) airborne infantry. So here I was, waiting to meet the new boss and wondering what the hell I'd gotten into.

Colonel David Hackworth's reputation preceded him and anxiety levels were running high. Rumor was he stood 8 feet tall, ate Cong for breakfast, kicked ass with the very best of them, and had been in-country since about the time of the industrial revolution. The bit about his time in-country was somewhat exaggerated, but the rest was surprisingly accurate.

Some serious changes were about to take place in our AO. The colonel told us straight out: We were gonna kick some ass, take Charlie's war to him, interdict his supply operations, take him out in his own backyard. We'd ambush him by night and take him out as he slept by day. Hack told us he'd take care of our young asses, No. 1 priority; that we'd have full support for the task at hand, and that he'd be right there in the shit with us —

not orbiting in his command and control ship.

The changes were immediate and dramatic. Muc Hoa and other SF camps became forward operating bases; Navy PBRs (Patrol Boat, River) inserted us deep into Indian country; we started doing frequent helicopter insertions. Long-range recon and ambush patrols netted unexpectedly good results. No place was safe from Hack's Reconos. We busted our balls day and night, and with our successful team efforts unit morale and cohesiveness soared. We became proud young soldiers doing a bang-up job for a real warrior.

This was not, however, the beginning of a turkey shoot. We took our licks, and casualties. The entire Delta was booby-trapped, and we had some ambushes turned around on us. Mr. Charles was a

Author saddles up for eagle flight out of Dong Tam, 9th Infantry Division base, South Vietnam 1969. Photo: author's collection



worthy, experienced adversary. Operating in the Delta, often for several days at a time, was brutal. Environmental factors probably caused more casualties than Charlie. Insects and other critters worked us over night and day. Day after day after day. We were always wet and filthy.

The Delta was like one large sewer. We humped in it, ate in it, slept in it, drank its water, and fought and bled in it. Skin broke down, leaving us susceptible to infections. Flesh sloughed off, exposing open ulcers. The terribly humid heat of the day became bone-chilling cold at night. Add the inherent dangers and rigors of combat — a grunt's life in the Delta was rough.

For four more months we took it to Charlie, always on the move, trying to best him at his game. We built fire support base Danger in the heart of his AO, the first such U.S. troop presence in Dinh Tuong province. Then, on the 22nd of May, we hit the big time!

The second platoon of Claymore Company was two or three days into an ambush patrol when in the wee hours we received word that we were to force-hump to a rendezvous with other elements of the 4th Battalion. Battle Company had air-assaulted into the base camp of the Viet Cong 261A battalion, and was engaged in a major firefight. They had succeeded in flushing the VC from cover, and as they attempted to flee into the countryside, our other companies blocked retreat. Tac air, gunships and artillery pounded the area mercilessly. We were giving the 261A a beating!

We moved into a static position among the bombed-out remnants of a small farm and kept our heads down, engaging VC elements as they approached. As my scout, Fee, and I hunkered down, out of the rubble came a chicken. Of course it

*Continued on page 70*



# 15TH ANNUAL SOF CONVENTION

SEPT. 14-18, 1994  
SANDS HOTEL,  
LAS VEGAS, NEVADA



You work hard and you deserve to play hard, too. Especially when having a good time also builds your skills and knowledge. Come enjoy five action-packed days and nights at this year's SOLDIER OF FORTUNE Convention. We promise non-stop activities, including:

**PUGIL STICKS** — and other competitive matches. Get in shape now so you can compete for **cash prizes**. Your body will thank you — so might your wallet.

**SEMINARS** — Topics ranging from combat weapon usage to military sitrep reviews, police tactics and survival in modern times. **Learn the truth firsthand from the men who have been there.** Free admission only to registered conventioners.

**EXPO** — Check out the latest in weaponry, ammo and other merchandise from **over 400 exhibitors**. Runs Friday, Saturday and Sunday. Free admission to registered conventioners.

**PARTICIPATORY EVENTS** — Receive expert training in a large range of courses including **parachuting & weapons training**.

**THREE-GUN MATCH** — Prestige and cash prizes for expert shooters and those who aspire to be (see separate ad in this issue).

**FIREPOWER DEMO** — An awesome display of firepower caps off an action-packed day at the range: team shoot-offs, manufacturers' new-product demos, skydiving, big guns & explosives. All day Saturday — free to conventioners.

**BANQUET** — Saturday night Awards ceremony features insightful speakers and savory cuisine. Dress is casual.

## 1994 SOF CONVENTION PRE-REGISTRATION FORM

Yes! I want to be a part of the 1994 Convention

Check or money order enclosed. \$135 must be received by Aug. 31, 1994. \$160 after August 31, 1994.

Full refund by 7/1/94  
Half refund by 8/15/94  
No refund after 8/15/94



Charge \$ \_\_\_\_\_ to my  MasterCard  Visa  
Card # \_\_\_\_\_ Exp. \_\_\_\_\_

Signature \_\_\_\_\_

Name \_\_\_\_\_

Address \_\_\_\_\_ Apt.# \_\_\_\_\_

City \_\_\_\_\_ State \_\_\_\_\_ Zip \_\_\_\_\_

Phone \_\_\_\_\_

T-Shirt Size S M L XL XXL (circle one)

Mail with Payment to:

SOF '94 Convention Pre-Registration  
PO Box 693, Boulder, CO 80306  
Tel. 1-800-800-7630 Fax (303) 444-5617

## Early Bird Registration

- First 500 conventioners will receive a 15th Anniversary commemorative pin.
- Twenty names will be drawn from first 500 conventioners — winners join Robert K. Brown for brunch.



# COMBAT WEAPONCRAFT

by Louis Awerbuck

## Countering Car-jackers

There was a time when car-jacking meant elevating your '57 Chevy to change a flat tire. These days, car-jacking can at best lead to the loss of your car, and at worst to the loss of your life. If you choose to surrender and gamble on the biggest table stakes of them all — read no further.

If, on the other hand, you choose to fight (which is also a gamble), all the worst-case situations must be taken into consideration during training. The bottom line with car-jacking is that you have to be critically aware of your surroundings, because of the disadvantageous circumstances under which you will have to commence your reaction. Due to the nature of car-jacking, it will always have to be a reactive process.

There are four primary locations where car-jacking takes place: (1) parking lots — especially those at shopping malls, offices, churches; (2) traffic intersections — typically at stop lights; (3) at home — driveway entrances or garages; and (4) gas stations. There is a fifth circumstance where people are tricked into stopping, usually to aid a supposedly helpless motorist, but this essentially falls under a different tactical category, and is discussed as such at the end of this article.

Taken in the above order, shopping malls and underground parking areas are the most dangerous — and probably most preventable — of car-jacking predicaments. The commonest victim is the lone female, such as a late-night shopper or professional (nurses and the like) coming off duty. This dilemma should not lead to a close-quarters situation, as it can be prevented by the accompaniment of a security guard to the vehicle. Needless to say, the "protector" should check around, underneath and inside the vehicle, then stand by until the potential prey is securely in the car with doors and windows locked and

engine running. There are also remote, radio-controlled pager-type alarm systems that illuminate the vehicle interior before the driver approaches the vehicle.

If no "bodyguard" is available, approach with extreme caution, *door key in hand*, and at least check both your surroundings and the vehicle interior before entering. Have some type of weapon available, even if it is only several keys protruding between your fingers: Nobody can hurt you with key-ruptured eyeballs. You may also want to consider a key-ring pepper spray device. Distasteful as this may seem, only violence controls violence under these circumstances. Obviously, if there are any suspicious signs on your approach across the parking lot, *turn around and leave*, and get help. Discretion is the better part of valor!

The traffic-light trick is usually initiated by a smack on the rear bumper by a trailing car. The good news about this scenario is that you usually have a couple of seconds to decide whether this is a criminal act or a genuine traffic accident. If you decide it's the former, and you have room to maneuver, *get your car out of there* and immediately head for the nearest law enforcement help. You will both save your neck and avoid prosecution for leaving the scene of an accident. Try to establish perpetrator and perpetrator-vehicle identification if possible. If you are boxed in by traffic, keep your doors locked and windows up and honk your horn frantically. Daylight or dark, criminals do not like attention.

Unfortunately, in dense traffic, driving out of the problem is extremely difficult and a defensive driving course from the likes of Tony Scotti or Bob Bondurant is highly recommended. Solution? Be aware of your surroundings at all times via your rear-view mirrors — and attach convex add-on mirrors to the factory standard side mirrors to enable you to keep *all* "blind" areas in your rear

vision at all times. In traffic, leave room between your car and the one you follow, so you have room to maneuver at stop lights.

The home-driveway-and-garage problem is also relatively easy to prevent. You are most vulnerable if you have to exit the vehicle to open a gate leading to the driveway, or if you have dense vegetation lining the driveway, and you are extremely vulnerable in the carport itself. The first two conditions are obvious and should be countered by electronic gate openers and judicious pruning, respectively. The garage/carport is a potential disaster area, because your defensive synapses usually shut down as you go through a mental stage of relief at having arrived home safe and sound.

Unfortunately, this safety may be illusory. Most people who live in urban "fortresses" don't take into consideration that the door leading from the carport to the inner house is often of poor construction — and *is often left unlocked* by the homeowner, merely because he/she relies on the security of closing the outer garage door.

*Scenario:* You arrive home after nightfall. As soon as you kill your headlights you are a night-blind sitting duck in your own carport. If Jocko is waiting for you, you've just become Thanksgiving dinner.

*Suggestion:* Use a remotely controlled garage door opener, always leave the light on in the garage, and *reverse* up your driveway and into the carport. Any suspicious indications — hit first gear, floor the car and get out of there. An additional bonus: your Chevy beats a knife or gun 10 times out of 10!

Gas stations are a popular car-jacking area because most people are so intent on watching the gas pump they don't observe anything else. If anybody already parked looks suspicious on your arrival — drive on. If not, use your side windows as mirrors for observation while filling up, and *don't* leave the



**The Grip that Tames the "Bull"**

Our finger-groove **PT99D/G** grip for the Taurus PT-99 decocker gives you comfort, control, and accuracy. See your gun retailer or call us at **1-800-423-9704**.

Send \$2 for 32-page color catalog.



**Pachmayr**  
The Champion's Choice™

1875 S. Mountain Ave. ■ Monrovia, CA 91016

## BODY ARMOR THAT STOPS .44 MAGNUMS and weighs only 3-lbs!



SOFT, COMFORTABLE, CONCEALABLE BODY ARMOR MADE WITH 18 LAYERS OF DUPONT KEVLAR (U.S. ARMORS IIA VEST HAS 14 LAYERS, ARMO-TECH HAS 15 LAYERS)

MED: \$149.99 LRG: \$189.99 XLRG: \$259.99  
Adjustable ballistic panel carriers available in white, navy, OD and brown.

### 5-YEAR WARRANTY ON BALLISTICS

Prepaid orders include shipping. \$10 charge for CODs. One week shipping for stock sizes. State height and weight when ordering. Money orders and certified checks accepted. CODs cash only.

**MICHIGAN BODY ARMOR**  
P.O. BOX 243 LATHRUP VILLAGE, MI 48076 313-788-2234

keys in the ignition. If you're perverted and *like* getting into gunfights, a flammable, explosive gas pump/station is not the place to do it. Join the Marines.

The moral of this story is not to run your car until it's on empty — gas up in a populous, safe area during daylight when you *choose* to, not at a Transylvanian Texaco at midnight because your car's running on fumes.

The aforementioned "stranded motorist" ploy is a sign of the times. While the age of chivalry isn't dead, it certainly has a severe case of emphysema, resulting from many good samaritans being car-jacked and killed. Here's a clue: Even if she's stark naked and looks like a goddess, if there are any areas of cover or concealment within the proximity of the "stranded" motorist — keep on trucking. And as soon as you see a "stranded" motorist, don't let tunnel vision stop you from checking the *opposite* side of the road or highway — that's the oldest trick in the book.

Especially if you're female and alone on a lonely rural road at night, *don't* stop for pursuing red and blue rotating lights unless you are 100% positive it's a police officer. If there's any doubt, maintain your legal speed until you have reached a populated area or police station — any law enforcement officer worth his salt will accept your explanation. (This assumes, of course, that you weren't breaking the law before the red and blues started flashing.)

The bottom line of this article is that prevention is better than cure. If you have to fight reflexively after noticing a gun muzzle growing out of your ear, you're probably going to be out of luck. Safety belts, armrests and steering wheels in cars and trucks all have extremely detrimental effects on your normal high-speed, low-drag handgun drawstroke.

Tactics, as always, are what will cause you to win or lose. The law of the jungle is to live to fight another day.

*Louis Awerbuck is director of Yavapai Firearms Academy, Prescott Valley, Arizona, and a frequent "Combat Weaponcraft" contributor. ✕*

# STEROIDS

ALTERNATIVES

**ALL PRODUCTS 100% NATURAL  
NO HARMFUL SIDE EFFECTS**

- DIBENCOZIDE 10 mg** is the most powerful steroid replacement on the market & 100% legal. *World records have been set while using this product!*  
**2 month cycle \$22.50**
- BORON 10 mg** naturally enhances testosterone levels so you can build muscle *without* the harmful side effects of illegal steroids.  
**3 month cycle \$15.95**
- GROWTH HORMONE RELEASER G.H.R.X.** Releases growth hormone in an abundance like no other. *Works great with Boron.*  
**60 tabs \$21.00**
- LEGAL STEROL COMPLEX** enhances growth. Allows body to stay pumped longer. Releases growth hormone and *strips away fat!*  
**60 tabs \$19.95**

**LIFETIME 100% MONEY BACK GUARANTEE**  
Buy Products 1, 2 & 3 and get #4 FREE. This will enable you to have the most powerful natural anabolic stack on the market.

**ORDER NOW! C.O.D.'S WELCOME**  
**1-800-398-6946** Ask for ext. 120  
Send Check or M.O. (Add \$4.00 for shipping)

**S&K LABS**  
2637 E. ATLANTIC BLVD., SUITE 101.  
POMPANO BEACH, FL 33062 **COD**



## TACTICAL ELECTRONICS



**LASER GUNSITE**  
Easily mounted, ready to use  
LATR1 ..... \$174.50



**BLITZER STUN GUNS**  
Hard Hitting  
Made in USA

STUN1 80KV, Curved Grip.....	\$49.95
STUN2 100,000 Volts .....	\$59.50
STUN3 120,000 Volts .....	\$69.50
STUN4 150,000 Volts .....	\$89.50

Caution - Check Local Laws

**Long Range Voice & Telephone Transmitters Combo**  
Easy to Assemble Kits  
#XFM/XTL300 (Special 2 in 1)..... \$34.50



**CRIMESTOPPER!**  
Self Defense Weapon  
- Stops an attacker up to 8'; also dogs  
- Contains identification dye markings  
BLTZ1 Multi-shot, key ring att. .... \$9.50

Complete Brochure FREE With Any Order!  
PLUS Explosive Paint Plans! 2 part mix, labeled dangerous, \$5.00 value!

## AMAZING CONCEPTS

ORDERS: 800-221-1705 - FAX 603-672-5406  
Send Check, Cash, Money Order, COD, MC, Visa to:  
Dept SF2, PO Box 719, Amherst, NH 03031

# SLICK WILLIE WATCH



## RETRACTION, CORRECTION, FESS-UP AND (GULP) SEMI-SUBJECT APOLOGY

Much of the material in this column is gleaned from published news items. We obviously don't have the staff to follow the Prez around waiting for him to step on his necktie. As a fringe element of the contrarian opposition, it's our job to consider the White House as an editorial free-fire zone — but it is also our intent to leave knee-capping to aspiring Olympians.

In the March 1994 issue of "Slick Willie Watch," we reprinted a story dealing with White House "Chef Bruno Bartoli" who had been hired @ \$10,000 a month plus benefits. It turns out that *this* Chef's Special is Baloney, and a goodly segment

of the fourth estate — including us — bought a hoax. His "announcement" was a publicity stunt.

The White House spokesperson we contacted was unable to discuss the salary or GS rating of the *real* White House chef, but assured us it was one Pierre Chambrin, and no one we talked to there (five various media relations people) had heard of "Chef Bruno Bartoli." Pity. We were really hoping for a point of contact for Bartoli as we'd really like to talk to him.

## CONTINUING HEAVY SNOWJOBS

The two federal bu-

reaucracies guilty of criminal recklessness in the Waco disaster — the departments of Treasury and Justice — were going out of their

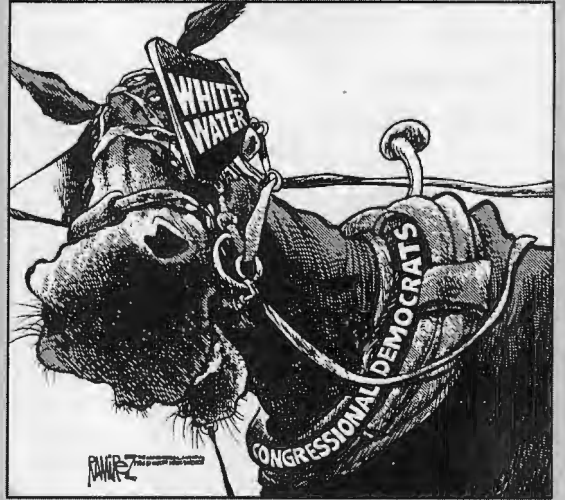

## Politically Incorrect Company

### Freedom of expression is a RIGHT not a privilege!

PIC is dedicated to offending each and every special interest group and politically correct organization in the country. This is the first in a series of politically incorrect T-shirts. Join us today in horrifying the powers that be! We use only premium quality American made 100% cotton T-shirts. Sizes M-L-XL-(XXL \$15.00) Order by Phone (318) 688-1365; Fax (318) 688-1367

I can't wait to see  
President  
Clinton's  
face...  
On a Milk Carton!

# T-8 \$14.00

Navy shirt with white and red design.

I DON'T TRUST  
PRESIDENT CLINTON  
OR HER HUSBAND

# T-1 \$14.00

Navy shirt with white and red design.

HINCKELY...  
SHOT THE WRONG  
BRADY!

# T-7 \$14.00

Black shirt with white letter design.



FEDERAL BUREAU OF INCINERATION  
"Come out, come out or we will burn you out!"

# T-2 \$14.00

Navy shirt with yellow and orange design.

MADE IN AMERICA  
by lazy and stupid workers



TESTED IN JAPAN

White shirt with a 5 color design. # T-5 \$14.00

### Politically Incorrect Company

P.O. Box 5362- pf  
Shreveport, La. 71135  
Phone (318) 688-1365

Card Exp. Date \_\_\_\_\_  
Issuing Bank \_\_\_\_\_

Signature \_\_\_\_\_  
 VISA  MC  CHECK  MO

ORDER#.	QTY	SIZE	PRICE	TOTAL
XXL Sizes available for \$15.00			Shipping and Handling \$4.00 per order	\$4.00
			Total	

Satisfaction Guaranteed or Your Money Back!!! © PIC 1993

way to generate good press as the trial of 11 Branch Davidians began in San Antonio. Coincidence? Maybe.

Flying all the way to China, a poker-faced Bentsen solemnly cautioned the communist government that they must polish their human rights record if they hope to be morally upright enough to horsetrade with that paragon of business ethic, our federal government. Inscrutable to a man, Chinese leaders must have snickered inwardly, diplomatic enough not to mention the U.S. government's human rights records in Idaho and Bentsen's home state of Texas. These were the sites of bloody botches begun against men with unconventional religious beliefs and no criminal convictions — Randy Weaver and David Koresh.

Meanwhile, Attorney General Janet Reno went to Dallas to prattle

about her "holistic approach to crime fighting" and her attack on crime's "underlying social problems..."

"I've become convinced that the child who watches his father batter his mother comes to accept

"Why is the attorney general talking about child care in the first place?" Reno noted rhetorically, "We have to begin to look at children as a whole ..." As opposed to looking at children as crispy little pieces?

Fortunately, not all Texans were snowed by Reno's blizzard of PR gibberish: Two brothers, Phillip and Caleb Hall, stood outside at Reno's speech, steadying a sign twice their height, with a plaintive message, "Please Don't Gas Or Burn Any More Children." —James L. Pate



violence as a way of life," said the eminent attorney general and field marshal. No disagreement there, but if that's so, what might a tyke learn from watching Reno's FBI Hostage Rescue Team "rescue" dozens of women and children in the Waco holocaust? You may ask,

### SECRETARY OF DEFENSE

Of the various proposed candidates for secretary of defense, the one who makes the most sense to us is John Wayne Bobbitt. He is a former Marine; he has experience with women in combat. And he has demonstrated an ability to survive drastic cuts. Plus, there would be no nanny problem. ✕

## The Leader In Technology for Seeing, Sighting, Photographing and Videotaping In The Dark

### NIGHT VISION WEAPON SIGHTS & VIEWERS



I GEN.  
**AN/PVS-2B**  
Weapon Sight  
**\$1695<sup>00</sup>**  
Plus \$100<sup>00</sup> for weapon mounting



I GEN.  
**SC/PVS-200**  
Viewer  
**\$1695<sup>00</sup>**

II & III GEN.\*  
**AN/PVS-4**  
Weapon Sight  
**\$2850<sup>00</sup>**  
New with Excellent Cond. Intensifier \*III Gen. POR

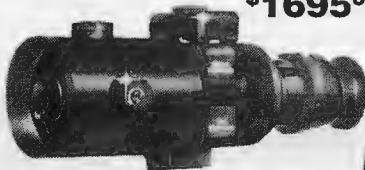

III GEN.  
**OSPREY**  
Mini-Weapon Sight  
**\$5800<sup>00</sup>**  
NEW UNIT



II GEN.  
**SC/PVS-400**  
Viewer  
**\$2995<sup>00</sup>**

### NIGHT VISION GOGGLES



II GEN.  
**NVG-500**  
Starlight Goggles  
**\$5850<sup>00</sup>**  
NEW



III GEN.  
**AN/PVS-7B**  
Mono-Tube Goggle  
**\$4850<sup>00</sup>**  
(Standard Unit)



II & III GEN.\*  
**NIGHT EXPLORER**  
Pocketscope  
**\$2195<sup>00</sup>**  
New with Excellent Cond. Intensifier \*III Gen. POR

## STANO Components

Catalog \$4<sup>00</sup>

P.O. Box 2048 • Carson City, Nevada 89702 • (702) 246-5281 / (702) 246-5283 / Fax (702) 246-5211

# If the enemy overruns you, Or legs. Or arms.



The A-10 attack aircraft was the butt of jokes—until the Gulf War.  
1891 \$23.00

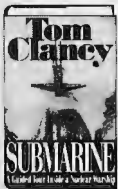

Tom Clancy's first work of non-fiction on nuclear submarines.  
3475 \$16.95x

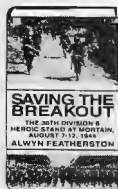

For 6 days, National Guardsmen slugged it out with Hitler's elite.  
3731 \$24.95



Practice the simple steps illustrated in *Survival on the Battlefield* and you'll improve your strength, your endurance, your speed and flexibility. You'll build, too, your confidence to handle any situation. With over 500 instructive photos, *Survival on the Battlefield* is the ideal training program. And it's FREE when you tap into the ideal source for military reading—*The Military Book Club*®!

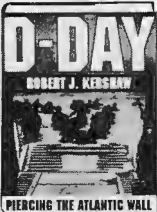

Allied and German servicemen recount their D-day experiences.  
2261-9999\* \$34.95

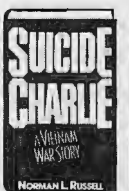

Powerful memoir of a 19-year-old hurled into combat in Vietnam.  
3335 \$19.95



A Vietnam vet shares his unique collection of unbelievable war stories.  
3012 \$12.95x

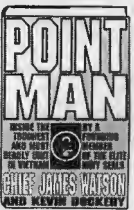

No man who walked right behind him was ever wounded!  
2949 \$22.00



Updated sourcebook on the newest wargame innovations.  
4093+ \$12.00



How the French and British commanders made Hitler look like a genius.  
3905 \$29.95



Meet men who place a single shot with surgical precision.  
5546 \$12.95x



A rare glimpse at the well-guarded world of America's elite warriors.  
2279 \$23.00



Three years after his leg was amputated, Hamblen fought in Vietnam!  
1776 \$22.50



The full story of Israel's stunning victory in the 1967 Arab-Israeli war.  
1834 \$30.00



On-the-range combat evaluations of more than 50 modern handguns.  
3947 \$29.95

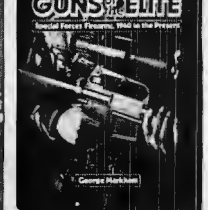

A detailed overview on the arms of elite combat units.  
4531-9999\* \$29.95

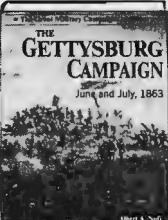

New in-depth look at the bloodiest campaign in America's bloodiest war.  
3046 \$19.95



The real story of Cochise, Geronimo and the Apache wars.  
1685 \$24.00



Six thousand tanks fight the greatest armor battle in history.  
2931 \$24.95

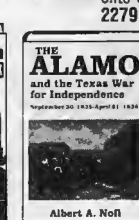

Full story of the battle that became the rallying cry for Texans.  
4085 \$18.95



How POW camps for Germans were run in the U.S.  
6783+ \$14.95



How to locate anyone who is—or was—in the military.  
4259+ \$19.95



The attempts by German citizens and soldiers to assassinate the Führer.  
4440 \$19.95



The special heroism of combat medics in Vietnam.  
6726 \$12.95x

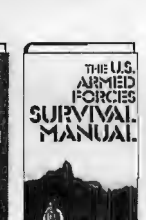

Survival techniques used by Green Berets and SEALs.  
8219+ \$9.95x



Patrol the Pacific with the most effective U.S. sub of WW II.  
8052 \$27.95

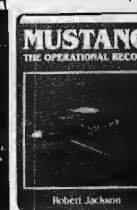

Complete story of perhaps the greatest piston-engine fighter of all time.  
3715 \$35.00



An unprecedented look at WW II by Japanese citizens.  
2717 \$27.50



War on the Eastern Front—through the eyes of a young soldier.  
9043+ \$15.95



It was supposed to be a minor mission in Nam. It became a month of agony.  
3467-9999\* \$48.00



Stirring story of the daring airborne attack to retake Corregidor.  
3897 \$22.95



Full account of the bloody struggle against the Japanese on Tarawa.  
1677 \$24.95



The evolution of American air power, from the end of WW I to V-J Day.  
4226 \$30.00



An undisciplined intelligence team tormented the VC...and Army brass.  
2303 \$12.95x



The Russians have attacked the Ukraine! Will the U.S. risk WW III? Fiction.  
3301 \$22.95

# you've got to use your head. Or hands.



6791+ \$14.95

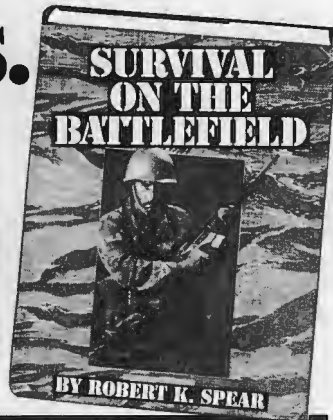

The successes—and failures—of air power in the Persian Gulf War. 4432 \$24.95

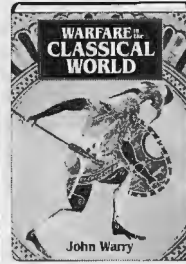

Over 2,000 years of classical military history in one illustrated volume. 2295 \$19.95x

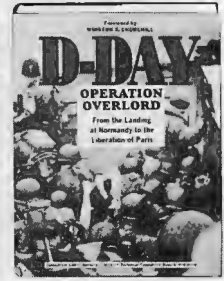

Color photos highlight this stunning account of the Normandy invasion. 4218-9999\* \$24.95x

**TAKE THIS BOOK FREE PLUS 3 for 98¢ with membership**



Full story of the Navy's Sea Air Land commandos. 4069 \$14.95x



The untold story of the Persian Gulf War. 0240 \$24.95



The only Navy corpsman to become a recon leader in Nam. 7955 \$17.95x

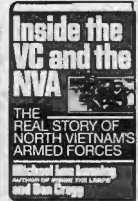

The training and performance of North Vietnam's fighting forces. 8029 \$20.00

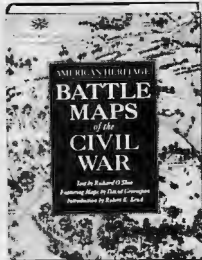

Full-color chronicle of 17 of the Civil War's greatest battles. 1594-9999\* \$32.95

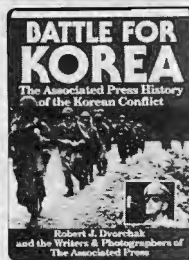

Revealing look at the private struggles of U.S. troops in Korea. Illustrated. 4168-9999\* \$34.95



The definitive, indexed translation of Clausewitz's classic military theory. 5652+ \$17.50



Korea? Iran? Here are 10 hot spots likely to see war in the 1990's. 1859 \$21.95



The definitive single-volume narrative of the American Revolution. 4457 \$35.00



The story of the legendary Red Baron who ruled the skies of WW I. 2287 \$27.95



Sixteen tales of the wild riding adventures of the Confederate Cavalry. 4119 \$22.00



A guide to military firearms. Over 500 illustrations. 1768+ \$18.95

## HERE'S WHAT YOU GET WHEN YOU JOIN...

**A GUARANTEE OF SATISFACTION.** Once your membership's accepted, we'll send your 3 BOOKS plus *SURVIVAL ON THE BATTLEFIELD*. If you're dissatisfied with them, return just the 3 books within 10 days at our expense. Membership will be canceled; you'll owe nothing.

**THE FREE CLUB MAGAZINE.** You'll receive up to 16 issues a year. Each reviews the Featured Book Selection(s) plus dozens of alternate books.

**SHOPPING MADE SIMPLE.** To get the Featured Book Selection(s), do nothing—it will be sent automatically. If you prefer another book—or none at all—return your Member Reply Form by the specified date. A shipping and handling charge (and sales tax, where applicable) is added to each order.

**HUGE DISCOUNTS ON HARDCOVER BOOKS.** Save as much as 30% off publishers' edition prices. Club books are sometimes altered in size to fit special presses.

**AN EASY-TO-MEET OBLIGATION.** Take up to 2 years to buy 4 more books at regular low Club prices. Afterwards, you may resign membership anytime.

**RISK-FREE RETURN PRIVILEGES.** If you get an unwanted book because your Club magazine was delayed and you had less than 10 days to respond, simply return the book at our expense.

Prices shown are for publishers' hardcover editions. Club hardcover editions save you up to 30%.

**THE MILITARY BOOK CLUB** ★★  
MAIL TO: The Military Book Club  
6550 East 30th Street  
P.O. Box 6357  
Indianapolis, IN 46206-6357

Your #1 Source for Military Books

**YES!** Please enroll me in *The Military Book Club* according to the risk-free membership plan described in this ad. Send me *SURVIVAL ON THE BATTLEFIELD* FREE, plus the 3 BOOKS I've indicated. Bill me just 98¢, plus shipping and handling.

**SAVE MORE—BUY YOUR FIRST BOOK NOW FOR \$3.99**

Send me the book I've indicated and reduce my commitment to only 3 more books. Bill me an additional \$3.99, plus shipping and handling.

(write book number)

48451 54

FREE BOOK #6791

48452 55

If you select a book that counts as 2 choices, write the first 4 digits of the book number in one row of boxes and 9999 in the next.

Mr./Mrs. Miss/Ms. \_\_\_\_\_ (please print)

Address \_\_\_\_\_ Apt. \_\_\_\_\_

City \_\_\_\_\_ State \_\_\_\_\_ Zip \_\_\_\_\_

Members accepted in U.S.A. and Canada only. Canadian members serviced from Canada, where offer is slightly different. Sales tax added where applicable. We reserve the right to reject any application. SOF 5/94

# WORLD SITREP

1

## JAPAN

British intelligence reports reveal that Japan has assembled all materials and technology to build a nuclear bomb in as little as 90 days.

2

## VIETNAM

Clinton normalizes relations with Vietnam.

Clinton administration releases a study that dismisses two Soviet documents purporting to show the North held more prisoners than it admitted. Report suggests the two documents are probably exaggerations as the number of prisoners cited exceeds the total number of known prisoners and missing pilots. Critics charge the study set out to disprove the documents rather than objectively evaluate them.

5

## BOSNIA

The CIA is deploying a ground satellite station and two Gnat-750 unmanned long-range recon drones to Albania to monitor the situation in Bosnia. This is partly a field test and partly to have them in position if skies suddenly become unfriendly.

Serbs meet 20 Feb. deadline for withdrawal of artillery, and threatened air strikes do not take place.

6

## COLOMBIA

Marxist rebels burst into political rally by former left-wing guerrilla group that had accepted amnesty, leaving 35 dead.

10

7

## PERU

During 1993, 1,692 people were killed in guerrilla-related violence, just over half of the 3,101 killed in 1992. President Fujimori credits this to his programs to end corruption and fight the guerrillas.

Gilberto Diaz Vasquez, commander of the civil defense militias, is killed in a rebel attack on Chiclayo.

12

9

## SIERRA LEONE

Government report that RUF rebels on verge of defeat proves premature. Heavy fighting reported in western region and rebels move to only 13 km from the regional capital of Kenema. Nigerian troops supporting the government.

Government troops recapture Normoh Faama, held by the rebels since 1992, while rebel forces capture the diamond mining town of Tonga Field.

6

7

10

## UNITED STATES

An unmarried female sailor gives birth to a child on the repair ship *Yellowstone*. The woman denied she was pregnant until testing positive; she then claimed she was only a few months pregnant but the baby was full-term.

Government will switch to a new procurement system, selecting contractors based on past performance rather than the lowest bidders. This was tried by McNamara in the 1960s and failed miserably.

The U.S. Senate votes to support permanent seats on the U.N. Security Council for Germany and Japan, but only if they accept the full responsibilities of that status, including deployment of peace-keeping troops.

World SitRep is excerpted from the biweekly newsletter *For Your Eyes Only: An Open Intelligence Summary of Current Military Affairs*. Published by Tiger Publications, P.O. Box 6759, Amarillo, Texas, 79114-8759; subscriptions are \$65 per year (26 issues). Sample issue available for \$3. Those interested in reliable, up-to-date world intel are encouraged to subscribe.

3

### IRAQ

Iraqi dinar falls to 190 to the dollar, the lowest level in history; Baghdad moves to take control of U.S. currency in the country.

Saudi inspectors seize the German-registered Asian Senator after finding 100 barrels of ammonium perchlorate, a component of rocket fuel, being shipped from China to Iraq.

Iraq has rebuilt most of its pre-war strength; it now has 2,500 tanks (mostly T-72s, compared with 5,500 pre-war tanks that were mostly T-55s) and 400 combat aircraft.

Shoot-out between Iraqi and Kuwaiti coast guard vessels wounds one Kuwaiti.

4

### TURKEY

Prime Minister Ciller says she is unable to deploy more troops to fight Kurdish PKK rebels because rise of Zhirinovskiy in Russia and return of Papandreou in Greece has raised "new risk factors." Second half of January saw 42 rebels, 23 civilians and one soldier killed in counterinsurgency ops.

11

8

### SOMALIA

U.N. releases eight captured aides of warlord Aidid, including chief financier Osman Atto.

U.S. Marines kill eight Somalis and wound 24 at the K4 intersection when gunmen attempt to ambush a convoy of American diplomats. Somalis claim the Marines fired first, presumably when they spotted the gunmen, without waiting to see if the gunmen intended to attack. A large crowd was present because Saudi troops were handing out free food, something they do without advising other U.N. forces.

5

4

3

13

8

11

### RUSSIA

Navy will mothball three of its five aircraft carriers due to lack of funds to keep them operational.

Navy complains that railroad officials are stealing train loads of fuel en route to naval warships in the Pacific and diverting the fuel to local power plants.

Clinton becomes the first U.S. president to spend the night inside the Kremlin.

12

### BRITAIN

Issues a new Code of Conduct to its military personnel. The new code absolutely prohibits homosexual activity and adultery, and strongly discourages officer-enlisted marriages.

14

2

14

### CAMBODIA

Government moves its largest artillery (152mm howitzers) into Samrong for anticipated offensive against Khmer Rouge stronghold. Calls on Khmer Rouge troops to defect before the dry season offensive crushes them.

13

### EGYPT

Continues its operations against Muslim militants. More than 1,000 police sweep southern Cairo in January, arresting 60. Egypt contends the militants who tried to kill prime minister had a list of nine other targets, including Israeli ambassador. President Mubarak rules out any dialogue with the fundamentalists.



## CLINTON UNABLE TO LEAD THE WAY

On October 3rd 1993, Corporal James E. Smith was killed in Mogadishu, Somalia, in the battle detailed in the January '94 issue of *SOF* by Colonel Hackworth. Smith was a 21-year-old fire team leader of 1st Platoon, Bravo Company, 3rd Rangers. A few days later, his parents received a letter from the White House. Here is that letter and his father's reply to the slickster:

*Dear Mr. and Mrs. Smith:*

*Hillary and I were very sorry to learn of the loss of your son. Specialist James E. Smith's death is a great loss for our nation, as well as for us personally, and our hearts go out to you in your sorrow.*

*Our efforts in Somalia have helped bring security and stability where anarchy, famine and suffering once prevailed. You should know that your son and his fellow service men and women have preserved the lives of hundreds of thousands of Somalis. Your son's courage, and his commitment to the ideals on which America was founded, will long be remembered with pride by his fellow citizens.*

*Our thoughts and prayers are with you.*

*Sincerely,  
Bill Clinton*

President Clinton:

As a warrior who was disabled in the Vietnam War and as a father of a warrior killed in action in Somalia, I cannot accept your letter of condolence for the death of my son. To accept your letter would be contrary to all the beliefs I, my son and the Rangers hold so dear, including: loyalty, courage and tenacity.

I had the honor to meet the Rangers who fought alongside my son and were with Jamie when he died. I heard of magnificent acts of courage and sacrifice. I heard

Rangers, with tears in their eyes, apologize for letting my son die or for their failure to break through and rescue the trapped Rangers. But the failure is not theirs, it is yours. Trucks and Humvees cannot replace the requested tanks,

they were hitting Aidid's forces and command structure hard. But, the United Nations was actually impeding Ranger missions by offering sanctuary to Aidid's supporters. Your willingness to allow this dangerous situation demonstrates a

lack of resolve in supporting the men you sent into battle.

My son is no longer here to "Lead the Way"; however, I am. Until you, as president and commander in chief, are either willing or able to formulate a clear foreign policy, establish specific



armored personnel carriers and Spectre gunships.

As a combat veteran I know that there are no certainties on the battlefield; however, as an infantry officer I will always speculate that significantly less casualties would have resulted if you, as commander in chief, provided the Rangers with the requested combat support — equipment with which the Rangers routinely train and for which approval should have been automatic. The Rangers were pinned down for 12 hours — long hours when they were fighting for their lives and a Delta Force medic fought to save my son. Jamie bled to death because the requested armor support was not there to break through.

Rangers pride themselves on the Ranger Creed. "Driving on to the Ranger objective," and "Surrender is not a Ranger word" are not hollow phrases to the men of the black beret. These soldiers understand the word tenacious and wanted to complete their mission. As Ranger after Ranger told me,

objectives and, most important, support the men and women in uniform, I will "Lead the Way" in insuring that you no longer send America's finest to a needless death. When you are capable of meeting these criteria, then I will accept your letter of condolence.

James H. Smith  
Captain/Infantry (Retired)

## BROKEN OATH

I would like to comment on your excellent article concerning the report of our prisoners of war being transferred to Russia during the Korean War ("Command Guidance" *SOF* Feb. '94). Most of the information in this report has been in the hands of our government since the end of the war. Colonel Caruso testified before the Senate Select Committee on POW/MIA Affairs last year that there were "hundreds" of reports concerning these transfers. At the time a policy decision was made to abandon these men. The same decision was made at the end of the Vietnam War.

The following is from a verse

# ANOTHER PEACETIME CASUALTY

You don't have to be in the service to appreciate a good boot. But it helps.

Thirty-mile forced marches, maneuvers in Alaska—it's familiar territory to a company that began outfitting loggers and trappers 54 years ago.

So we weren't surprised to hear a while back that some lieutenants from Fort Lewis were buying our boots and dyeing them.

"Why don't you make these in black?" they asked.

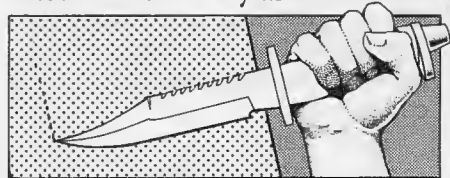

Our 1000 denier Cordura® nylon insets have ten times the tensile strength of leather. And less than half the weight.

That sounded like an order to us, so we had our full-grain



One firefighter said our Tibinsulate® insulation was so good he couldn't tell his boots were on fire.

leather tanned black inside and out (that way it doesn't show white at the seams), cut it

two inches taller at the top (so you can tuck your pants in), and added D-rings (for dress wear).

And now we're even taking orders from raw recruits. All over the country.

But you're not the only people who work with your feet.

Think of the police.

Firefighters.

Letter carriers.

We did, and

we now offer

the full range of service footwear, including the only walking shoes

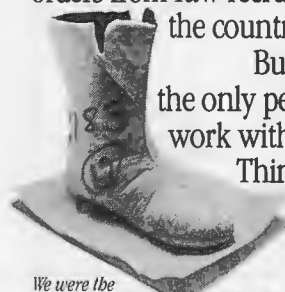

We were the ones who invented the waterproof Gore-Tex™ liner seven years ago.



with components proportioned to size. And with heel wedges designed to disperse shock.

No matter what you do, call Danner for the boots and shoes

to do it in. Because chances are it's not your feet that are killing you. Chances are it's the other way around.

**Danner**

Call us for a free brochure or the name of your nearest Danner dealer.

1-800-345-0430.

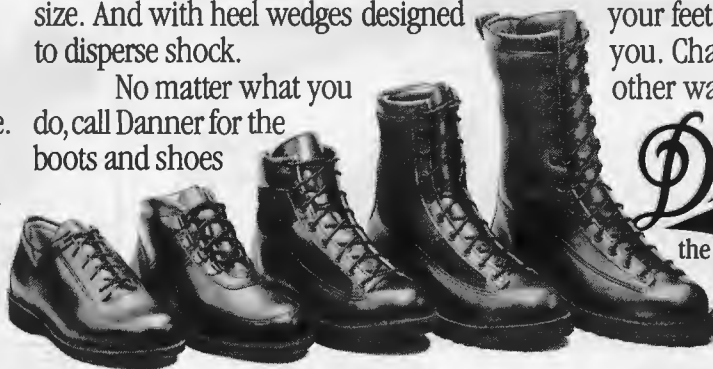

over the door at Delta Company, 6/31st, 9th Infantry in 1970, Vietnam: "I will not disgrace the soldier's arms nor abandon the comrade who stands at my side."

This sacred oath has been broken by our government, not the military. The POW issue will continue to be a black mark against the history of the United States.

Daniel Wood  
Elizabeth, New Jersey

**U.S. SLEEPS WITH COMMUNIST CONCUBINE**

The U.S. government continues to betray our abandoned soldiers in Southeast Asia by: disregarding all evidence of survivors; replacing competent, experienced POW/MIA investigators with young soldiers with no field experience or intelligence training; patently writing off our guys as dead based on a single tooth; buying every blatant communist lie; rewarding Hanoi with \$3.5 million American dollars in "humanitarian aid."

The White House beatniks and international profiteers are salivat-

ing to exploit Vietnam's oil and slave labor. Bill Clinton is the last person who should close the book on Vietnam! But under Clinton, and with Ron Brown's \$700,000 love affair with Hanoi, the communist concubine will offer herself to the highest bidder. Another atrocity: Clinton's POW/MIA mouthpiece is Asst. Sec. of State Winston Lord who played a large role in the 1970 cover-up of the loss, capture and holding of U.S. Special Forces, Air Force and CIA personnel in Laos.

Diane Palmer  
Gulfport, Mississippi

**DEEP SIX THOSE POW/MIA FLAGS**

Now that the president has lifted the trade embargo on Vietnam, it's time to remove all those POW/MIA black flags that blight so many public buildings across the nation. Government buildings that fly that flag are flying it in direct contradiction of the politically correct views that Americans have never been held captive in Southeast Asia and the whole MIA mystique is a myth. The

continued display of those offensive reminders of the "war to be forgotten" is a slap in the face of our president's magnanimous acquiescence to the interests of corporate greed.

As a nation we should follow the president's example by insulting and ignoring, even more than we already have, the surviving American veterans who foolishly served in the armed forces during that unfortunate police action. We should forget and dishonor those who gave their lives and abandon the few who may, despite the pronouncements of our infallible government, still exist in the living hell of jungle captivity.

It is far more important to America that a handful of multi-national conglomerates and billionaire lobbyists increase their profit margins. In addition, corporations will reap the benefit of a new source of cheap, expendable labor, eliminating the expense of cost-intensive, lazy American workers.

Steve Carlin  
Park Forest, Illinois

# NIGHT VISION

**AN/PVS-2B**

(GEN I)

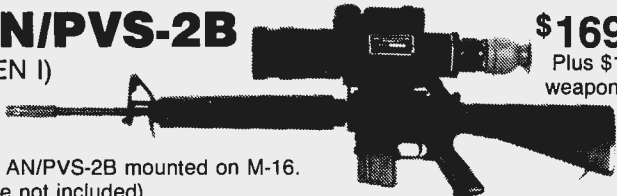

The AN/PVS-2B mounted on M-16. (Rifle not included)

**\$1695.00**

Plus \$100 for weapon mount

**AN/PVS-4**

(GEN II)

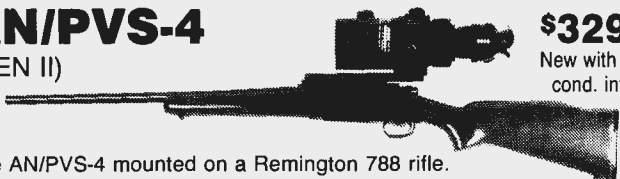

The AN/PVS-4 mounted on a Remington 788 rifle. (Rifle not included)

**\$3295.00**

New with excellent cond. intensifier

**NVEC 500 MINIATURE (GEN II) POCKETSCOPE with camera adapter!**

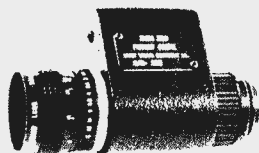

**\$3395.00**

Plus Shipping

**NIGHT VISION GOGGLES**

New w/Factory New Image Intensifier (1 yr. wty.) Operates on "AA" batteries!

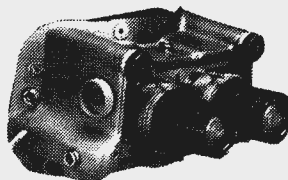

(GEN II)  
**NVEC 800 (AN/PVS-5C)**  
**\$5850.00**

Plus Shipping



(GEN II)  
**AN/PVS-7B**  
**\$3850.00**

Plus Shipping

**Excalibur Enterprises**

P.O. Box 400, Fogelsville, PA 18051-0400  
ph: 215-391-9106 FAX: 215-391-9223

**DEALERS! INQUIRE ABOUT OUR SPECIAL PRICING PROGRAM**

Night Vision goggles and viewers. Extensive parts inventory for both First and Second Generation Systems, plus reconditioning and general repair.

Send \$4 for our complete catalog  
**NO F.F.L. REQUIRED**  
COMPLETE LINE  
of individual & crew-served weaponsights.

# PNEU-GUN™

## Air Powered Ballistic Baton



The "PNEU-GUN" (pronounced *new-gun*) is a fistful of security. It is only 14 inches long when assembled and fires out a lead pellet filled "Shotbag" at a muzzle velocity of 250-300 f.p.s. One CO2 gas cartridge supplies sufficient energy

to knock down a 300 lb. assailant 20 feet away. The "PNEU-GUN" air powered ballistic baton is awesome! You have to see it in action to believe just how effective it really is. Don't confuse "PNEU-GUN" with old style "stun guns", "Un-Guns" or "Bean Bag Guns". There is no comparison in power, quality, range, effectiveness or sheer beauty of design. Keep one in your car, next to your bed or handy for that unexpected emergency. The "PNEU-GUN" air powered ballistic baton is the perfect alternative to a handgun. Legal, effective, yet safe to use.

**AG1 ... "PNEU-GUN" Airgun Kit ... \$169.95**

(includes Airgun, 4 Shotbags, 6 CO2 cartridges, 10 gas check, 10 white end caps, loading cartridge, instruction book)

### SAP GLOVES

Made of soft, pliable, long wearing leather. Has six ounces of powdered lead carefully inserted into the fist of each glove. High quality and available in three sizes, medium, large and X-large.

**DAM ... Sap Gloves ... \$44.95**

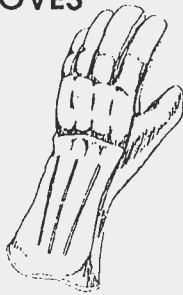

### PHONE CHECK

Telephone bug detector

This unit has both a light emitting diode and a meter read out. Will tell you if your line is interrupted while in use. Will also automatically shut down the line if a bug is detected or an extension is picked up.

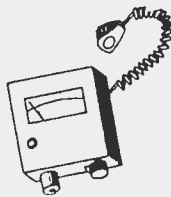

**ST1 ... Phone Check ... \$79.95**

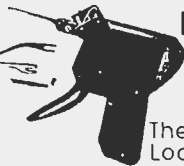

### LOCK PICK GUN

The famous Lockaid tool was designed for law enforcement agencies to quickly pick pin-tumbler locks. Unlike conventional hand picks that activate only one or two cylinder pins, this tool is designed to snap all the pins at once. This tool comes complete with 3 steel needles and tension wrench.

**AZL15 ... Lock Pick Gun ... \$59.95**



### DELUXE LOCK PICK SET

Our top selling pick set! This set has 16 pieces and comes with a handy shirt pocket sized case. The case is made of top quality leather and is zippered. Each pick is made of hard finished spring steel. Perfect for wafer tumblers or six or seven pin tumbler locks.

**AZL10 ... Pick Set ... \$39.95**

### BALLISTIC KNIFE

Congress outlawed the springs which enabled this knife to shoot its blade with deadly force. The Ballistic Knife was invented by Russia and issued to their elite "Spetsnaz" forces. This knife based on the original Soviet version which is able to fire its blade silently out of the knife handle with five times the force of a manual stab! This American made copy of far superior to the original and its unique firing ability was so effective, a federal law was made that out-laws any knife with a propelled blade.

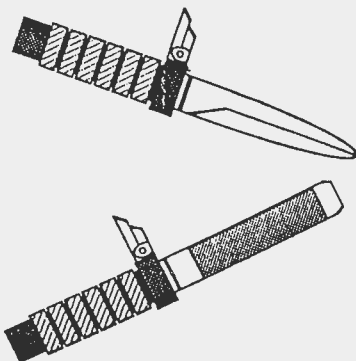

Now you can get this knife in kit form. The handle and sheath are made of aircraft grade aluminum. The blade is tempered out of 4140 steel with a rockwell hardness of 56!

**FCC1 ... Ballistic Knife ... \$139.95**

### NOVA XR5000 STUN GUN

This model is used by over 600 law enforcement agencies. The best quality and probably the "hardest hitting" stun gun around. The NOVA XR5000 has had more successful take-downs than all other stun guns put together. The NOVA XR5000 is the most widely accepted nonlethal defense device based on electronic pulse technology. Comes complete with NiCad battery charger, and belt clip holster.

**NV1 ... XR5000 ... \$79.95**

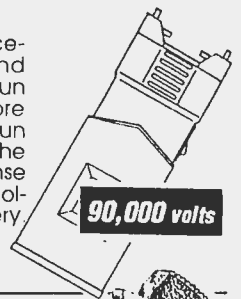

**90,000 volts**

Introducing --

### BODYGUARD 2000 DEFENSE PEPPER SPRAY

BodyGuard 2000 is the newest state-of-the-art self-protection product available. Easily controls drunks, psychotics, multiple attackers as well as drug abusers. Not a tear gas but a *natural red hot pepper*.

Formula used by police worldwide!

**BSD2000 ... BG2000 Keyring ... \$17.95**

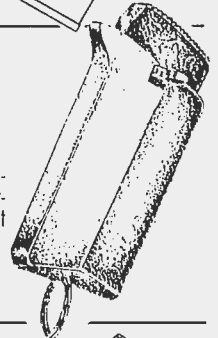

### BIONIC EAR

This sound amplifier system increase sound by up to 30 db. It comes complete with headphones, wrist straps that allow hands-free use and a 12 inch parabolic booster that makes the unit more directional. Automatic safety circuit prevents sound over 95 db from reaching your ears. Also has mono output jack for recording.

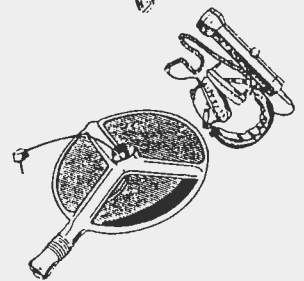

**SC11 ... Bionic Ear ... \$139.95**

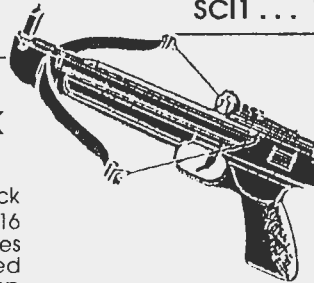

### PISTOL CROSSBOW

This compact pistol version of the deadly and silent crossbow is now available. This unit has fully adjustable sights, is amazingly accurate, comes in two different versions (50 lb. draw and 80 lb. draw) and comes with three practice arrows.

**PC1 ... 50 lb draw ... \$49.95**  
**PC2 ... 80 lb draw ... \$59.95**

### ORDERING INFORMATION

By Mail: Mail coupon or separate sheet with payment or credit card information to:

**SONIC TECHNOLOGY, Inc., 10105 E. Via Linda, Scottsdale, AZ 85258**

By Phone: Call 1 (800) 538-0787. Have all information ready.

Sonic Technology, Inc. does not warrant that you may legally possess or carry stun guns, pepper spray, etc. By ordering you acknowledge that you are an adult and there are no legal restrictions.

<b>SONIC TECHNOLOGY, INC.</b> 10105 E. Via Linda, Ste. 103-261			
<b>1 (800) 538-0787</b>		Scottsdale, AZ 85258	
Qty	Number	Description	Price
Charge My: Visa <input type="checkbox"/> MC <input type="checkbox"/> Amex <input type="checkbox"/>		Subtotal	
Card #:		Shipping	<b>\$5.00</b>
Exp. Date:		Total	
Name: _____			
Address: _____			
City/State/Zip: _____			
<input type="checkbox"/> Please Send New 1993/1994 32 page Catalog. \$2.00 Enclosed			

## SOVIETS TORPEDOED USS SCORPION

In reference to your February '94 article "Run Silent, Run Deep," I was a crypto and control supervisor in 1968 and recall when the *Scorpion* missed a sub check — the place went apeshit. I think that was in July of '68, though the wreckage was not found until early fall of that year.

I was on watch when the message was received that the *Scorpion* had been found near the Azores. In fact, I took the message off the teletype and to the watch officer and was told not to disclose the receipt of the message to anyone else in the watch section. Thereafter, all messages about the *Scorpion* were classified "Top Secret."

The *Scorpion* was a "spook" (spy) boat at the time. They were "spooking" a Soviet boomer (missile boat). This was done on an ongoing schedule to identify Soviet patrol patterns/routes. As you may know, a sub is blind to the

rear and turns frequently to listen to what may be following. During one of these turns *Scorpion* was discovered and a Soviet fast attack boat fell in behind her. *Scorpion* had originally been spooking the Soviet boomer in the Med, but followed her into the Atlantic. Some type of confrontation occurred and the Soviet fast attack boat torpedoed the *Scorpion*.

There were other incidents that occurred that would cause public panic. Man, does the government tell some lies to cover their asses or what?

"Bubble Head 68"

### DEGAN GOT HIS DUE

With regard to Marshal Degan, in the February 1994 issue's "Flak" column, Sergeant Butler states "his murder can in no way be justified." I want to point out that, in essence if not in fact, a jury of Randy Weaver, Kevin Harris and Marshal Degan's peers found that Degan's death was justified. Apparently, Degan was

killed in self defense by Harris or was killed accidentally by his own co-conspirators.

I say co-conspirators because a cursory review of the published facts in this case indicate the original incident that initiated the sequence of events eventually leading to the justifiable killing of Degan and the murder — yes, murder — of Sam Weaver and Vicki Weaver were the result of a conspiracy to coerce Randy Weaver to perform actions that were against his will and against his own perceived self-interest and conscience; in fact, a conspiracy to deprive Randy Weaver of his privacy, his freedom to act as he chose; a conspiracy to deprive Randy Weaver of his very basic constitutional rights.

Though he may have been in the past, in this scurrilous episode, Degan was definitely not "one of the good guys."

Robert Paul Johnson  
Powell, Tennessee ☞

# SKS and AK ACCESSORIES

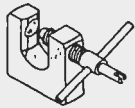

**AK & SKS FRONT SIGHT TOOL** all steel, adjusts windage and elevation (#G2033) \$29.95

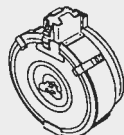

**AK COMMANDO 75RD DRUM** 7.62 x 39mm cal. These are the same drums used by assault teams world-wide. Also fits Valmet, Madi, Hungarian, etc. (#G2000) \$109.95



**SKS/AK STRIPPER CLIPS** These are new, no rust! 10 per pack (#G2013) \$6.95

**SKS DETACHABLE\* 30 RD MAGS** looks just like the AK mag. No modifications required for the weapon. (#G2092) \$29.95

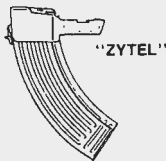

\*Detachable SKS mags are sold only for replacement on SKS's using detachable mags prior to 11/90 sec. 52(F)

**Get yours before these are banned!**

**AK or SKS STOCK EXTENSION** black rubber buttpad, extends the stock out an extra inch. Has hole for easy access to cleaning kit. AK Stock extension (#G2006) \$9.95 SKS Stock extension (#G2007) \$9.95



**AK CHEST POUCH** Holds six 30-round AK magazines, plus for small pouches for stripper clips, cleaning kit, etc. (#G1619) \$17.95

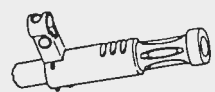
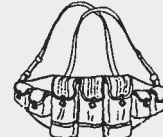

**SKS MAXI BREAK** provides excellent muzzle control, reduces flash and cuts recoil. (#G2055) \$34.95

**AK RECOIL COMPENSATOR** Based on the original Kalashnikov design, but made in the USA (#G2005) \$29.95



Exact copy of Russian Unit

**BEST SELLER!** **SKS & AK OWNERS MANUAL** a must for every SKS, AKS, or AK-47 owner or user. (#GB-896) \$3.95

**AK SPEED LOADER** original Chinese (#G2001) \$8.95



**SKS PISTOL GRIP** makes your SKS look and feel like the AK47. (#G2019) \$23.50

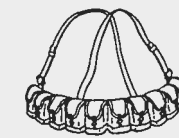

**SKS BANDOLIER CHEST POUCH** original Chinese, has 10 pockets, adjustable straps. Great for carrying ammo and stripper clips. (#G1631) \$14.95



**SKS FOLDING STOCK** fits both spike and blade bayonet models. (#G2064) \$79.95

**AK and SKS FOLDING BI-POD** all steel. Attaches quickly. (#G1790) \$46.95

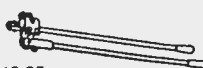

**AK VERTICAL FOREARM** offers more control and less heat buildup. Works on all Norinco or Polytech AKS with folding or wood stocks. Sturdy one-piece construction. (#G2039) \$24.95

**AK and SKS 5-PIECE COLORED FRONT SIGHT SET** Gives you a better sight picture than ever before. Red, white, yellow, orange and black. (#G1305) \$4.95 set



**ORDERS ONLY CALL**  
**1-800-239-7435**  
205-222-1931 / FAX 205-222-2309

SHIPPING CHART	ADD
0.00 - 35.00	4.95
35.01 - 60.00	5.95
60.01 - 100.00	6.95
100.01 - 150.00	7.95
150.01 or over	8.95

\*AK, HI, Canadian orders add \$4.00.

**CALL TOLL FREE TO ORDER**  
**OR SEND CHECK OR MONEY ORDER TO**  
**CROWN SPECIALTY CO.**  
DEPT. SF, P.O. BOX 488 • ANDALUSIA, AL 36420

# NIGHT VISION

Lowest Prices in the United States from \$249

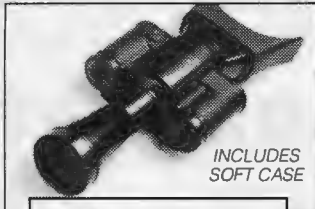

INCLUDES  
SOFT CASE

**B6 Starlight**  
GEN II PANORAMIC VIEWER

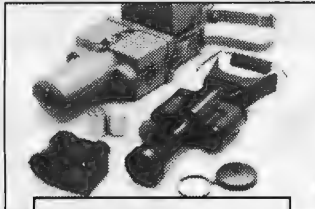

**1PN-50 Starlight**  
GEN II A+ MILITARY

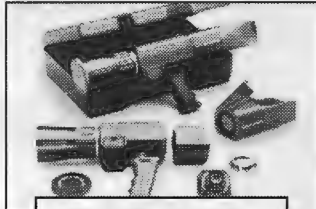

**B7 Starlight**  
GEN II CAMERA READY

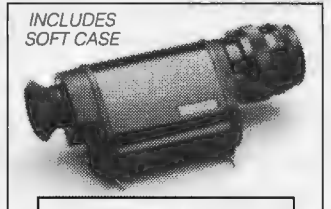

INCLUDES  
SOFT CASE

**Panther**  
POLICE MODEL w/ IR BEAM



INCLUDES  
SOFT CASE

**B12 Starlight**  
2.5x INTERACTIVE ICT



INCLUDES  
HARD CASE

**BN-453 Starlight**  
3.2x INTERACTIVE ICT

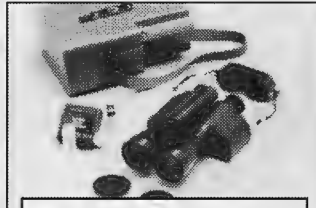

**B-336 Starlight**  
3.2x ICT A+ MILITARY



**PNV Night Hawk**  
2.5x INTERACTIVE ICT

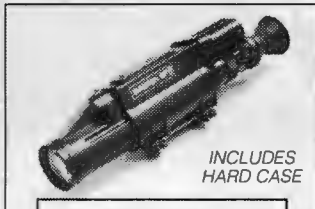

INCLUDES  
HARD CASE

**B-5P Starlight**  
GEN II RIFLE SCOPE

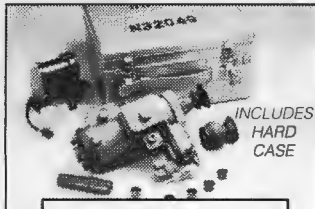

INCLUDES  
HARD CASE

**PN-51**  
GEN II 4x RIFLE SCOPE

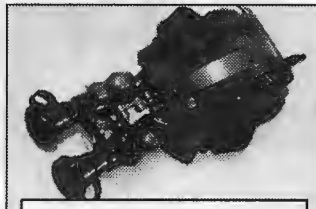

**PNV-57E Starlight**  
LONG DISTANCE GOGGLES



**B-20 Starlight**  
MACRO FOCUS



- Full 1-year factory warranty—ALL PRODUCTS
- 1<sup>ST</sup> 2<sup>ND</sup> & 3<sup>RD</sup> Generation Night Vision products
- FREE catalog of these and many other models
- Night Vision models as low as \$249!
- Call for our monthly special offers
- Largest U.S. supplier of Night Vision and other specialized optical devices
- Finest single source of daytime & Night Vision products for every application
- Rental and Leasing Available
- Major Credit Cards Accepted

## U.S. General Technologies, Inc.

145 Mitchell Avenue • South San Francisco, CA 94080

Orders: 800-445-3300 • Information: 415-634-8440 • 24-Hour Fax: 415-634-8452

# HANDGUN CONTROL

**ONE MILLION STRONG...working to keep handguns out of the wrong hands.**

*Notes and minutes of meeting of Friday, December 17, 1993 — rough draft proposal for internal memo and five-year plan.*

## WHAT IS PENDING NOW AND CAN BE LAW IN 1994

- Ban of all clips holding over 6 bullets
- Ban on all semiautos which can fire more than 6 bullets without reloading
- Ban on possession of parts to convert arms into military configuration
- Ban on all pump shotguns capable of being converted to more than 5 shots without reloading
- Banning of all machine guns, destructive devices, short shotguns/rifles, assault weapons, Saturday Night Specials and non-sporting ammunition
  - Arsenal licensing (for possession of multiple guns and large amounts of ammunition)
  - Elimination of the Department of Civil Marksmanship [sic], long considered a sacred cow and a dinosaur from the Cold War years (Thank you Mr. Clinton!!!)
- Ban on possession of a firearm inside a home located within 1000 feet of a schoolyard
- Ban on all realistic replicas/toy gun or non-firearms capable of being rendered realistic
- The right of victims of gun violence to sue manufacturers and dealers to be affirmed, and perhaps aided, with money from government programs
- Taxes on ammo, dealers' licenses and guns to offset the medical costs to society
- The eventual ban of all semiautomatics (regardless of when made or caliber)

## WHAT WAS ONLY A DREAM 10 YEARS AGO CAN BE REALITY AS EARLY AS THIS YEAR!

After the meeting, the following ideas were the result of a brainstorming session to guide the focus of gun

control initiatives over the next five years. These may not be politically feasible ideas for 1994, but we are confident that with continued pressure we can achieve most if not all of these goals within the next five years. The following list is condensed from our meeting in which we considered the best ideas for public safety expansion. The time is right for action.

## Five-Year Plan

### 1. NATIONAL LICENSING OF

# HCI's TRUE AGENDA?

# ELIMINATING ALL PRIVATE GUN

# OWNERSHIP IN AMERICA

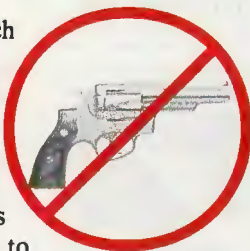

## ALL HANDGUN PURCHASES

This is at the top of our list, however, the political climate may be right to initiate this step immediately. Please refer to our memo outlining our ideas on how this should be executed.

**2 LICENSE FOR RIFLE AND SHOTGUNS** • We should take our cues from Great Britain. Strict licensing should be *mandatory* for all firearms, whether handguns or not.

**3 STATE LICENSES FOR OWNERSHIP OF FIREARMS** • We want to take a workable idea from Great Britain, whereas, we should require the states to issue strict licenses for possession and require the licenses to be signed by at least three public officials — the police chief, city attorney and the mayor, for example — to eliminate ownership by dangerous individuals. It is reasonable to require that all individuals must prove to the signers that they require a firearm.

**4. REDUCTION OF THE NUMBER OF GUNS TO REQUIRE AN**

**ARSENAL LICENSE** • Right now the proposed arsenal licenses which Sen. Feinstein should be pushing for, requires an "Arsenal License" for those people who feel they need more than 20 guns and 1000 rounds of ammunition. We feel that number is too generous, due to the fact that any number of guns constitutes a grave threat to the safety of the community; we suggest strongly that this license limit be reduced to possession greater than 5 guns and 250 rounds

of ammunition.

**5. ARSENAL LICENSE FEES**  
It is not unreasonable to require a yearly fee for an arsenal license to be at least \$300, with a cap of \$1000. The money collected can be used to defray the immense medical costs directly attributed to these deadly weapons.

**6. LIMITS ON ARSENAL LICENSING** • No arsenal licensing to be permitted in counties with populations of more than 200,000.

**7. REQUIREMENT OF FEDERALLY APPROVED STORAGE SAFES FOR ALL GUNS** • We should follow Great Britain's lead on this. All licensed gun owners should be required to have a storage safe which meets minimum federally mandated requirements. This step would reduce the tragic accidents that claim the lives of tens of thousands of children a year and make it more difficult for burglars to steal guns.

**8. INSPECTION LICENSE** • Another good revenue source would be

mandatory inspection licensing of all safes. Each safe would be registered with a specific serial number, and the serial numbers and types of weapons stored should be on file with federal and state authorities. Since unannounced inspections can insure that all declared weapons are being properly stored, all safe licenses should have an additional yearly fee to offset the cost of these spot inspections.

**9. BAN ON MANUFACTURING IN COUNTIES WITH A POPULATION OF MORE THAN 200,000** • Guns are being built all the time and the number of licensed manufacturers are too great to justify the threat to public safety. This is a small step to reduce the number of these shops where even machine guns are being built every day.

**10. BANNING ALL MILITARY STYLE FIREARMS** • The pending national ban on all assault weapons, based on a point system can be expanded to eventually cover any firearms with a remotely military appearance. We feel that this aggressive appearance appeals to the type of dangerous individuals who are a definite threat to public safety. We hope that this point system can eventually be expanded to high-powered air guns and "paint ball" weapons, which can inflict great damage, and with a little effort can be converted to real guns.

**11. BANNING OF ANY MACHINE GUN PARTS OR PARTS WHICH CAN BE USED IN A MACHINE GUN** • Periodicals such as *Shotgun News* particularly cater to individuals who wish to build illegal machine guns. If Sen. Feinstein's courageous section of the crime bill is successful in banning all machine gun parts except for police and military, then there would be no legitimate need for machine gun parts except to build illegal weapons.

**12. BANNING THE CARRYING OF A FIREARM ANYWHERE BUT HOME OR TARGET RANGE OR IN TRANSIT FROM ONE TO THE OTHER**

**13. BANNING REPLACEMENT PARTS EXCEPT BARREL, TRIGGER GROUP** • Thousands of people are building illegal weapons every day. We can put a dent in this by banning parts and parts kits, except those items like the barrel and trigger group, which are most likely to wear out due to use.

**14. ELIMINATION OF THE CURIO RELIC LIST** • A gun is a gun. Even an old gun can kill people. This is a loophole in the federal law which has allowed thousands of dangerous weapons to be distributed unchecked. This regulation, if enacted, would automatically eliminate the need for a curio or relic collector's license. All handguns, rifles and shotguns would fall into the same category as their modern counterparts.

**15. CONTROL OF AMMUNITION BELONGING TO CERTAIN SURPLUS FIREARMS**

**16. BAN ON HANDGUN POSSESSION**

This may be closer to reality than many of us think. Handguns are becoming increasingly unpopular and we think that within five years we can enact a total ban on possession at the federal level.

**17. BANNING OF ANY AMMO THAT FITS MILITARY GUNS (POST 1945)** • With the proliferation of high-powered weapons, including semiautomatics and automatics from World War II, we suggest following the lead of Mexico, by prohibiting the sale, manufacture, possession or transfer of any caliber fitting a military firearm in service with a recognized military force after 1945.

**18. BANNING OF ANY QUANTITY OF SMOKELESS POWDER OR BLACK POWDER WHICH WOULD CONSTITUTE MORE THAN THE EQUIVALENT OF 100 ROUNDS OF AMMUNITION** With the bombing the World Trade Center, it has been made clear that we must reinforce the above proposed regulation with this additional notation. It is arguable that no one has



**20. BANNING OF HIGH POWERED AMMO OR WOUNDING AMMO** • In addition to the banning of military calibers, there is a plethora of dangerous rounds which are too high powered for sporting use. This includes the highest calibers of pistol and rifle ammunition (of note are the monster calibers for rifles and pistols, like the .50-caliber Desert Eagle Bullet). We should not forget the lessons learned with the insidious Black Talon Ammo, hollow points, Glaser killing rounds and other types of ammunition designed specifically for maiming.

**21. NATIONAL LICENSE FOR AMMUNITION** • This is an idea whose time has come. We should look at a Federal License for purchasing of ammunition of all kinds. A special form should be forwarded to a new federal office to track those who are purchasing too much ammunition. Remember that a gun is useless without ammunition.

**22. BANNING OR STRICT LICENSING OF ALL RELOADING COMPONENTS** • Ammunition regulation laws can be regularly bypassed by home loaders, creating an underground cottage industry of ammo manufacture. Possession or purchase of reloading equipment and machines should be restricted and those who wish to use specially loaded ammunition can go to a federally licensed reloader.

**23. NATIONAL REGISTRATION OF AMMUNITION OR AMMO BUYERS** • Fees collected from the national licenses should go toward establishing a nationwide database for the purchasers of ammo with a possible background check to

HCI — Confidential Document

DO NOT DISTRIBUTE OR COPY/NOT FOR GENERAL CIRCULATION

any real need to have so much dangerous material on hand.

**19. BAN ON THE POSSESSION OF EXPLOSIVE POWDERS OF MORE THAN 1 KILOGRAM AT A TIME** • Gun nuts are notorious for circumventing the intent of the law, so we can reinforce the above proposed regulation with this additional notation.

eliminate felons or mental patients.

**24. REQUIREMENT OF SPECIAL STORAGE SAFE FOR AMMUNITION AND LICENSING** Like the storage safe for guns, there should be a national requirement for special safes to store ammo. These safes should be tamper-proof and fire-proof and be registered themselves so that on-the-spot inspections can



be held. Again, the costs for these inspections can be absorbed by the license fees.

#### 25. RESTRICTING GUN RANGES TO COUNTIES WITH POPULATIONS LESS THAN

HCI — Confidential Document

DO NOT DISTRIBUTE OR COPY/NOT FOR GENERAL CIRCULATION

200,000

#### 26. SPECIAL LICENSING OF RANGES

27. SPECIAL RANGE TAX TO VISITORS • Additional revenue can be a surtax on ranges, requiring the collection of a minimum of \$85 per visit per person. This can be in addition to required membership fees, from which state and local governments get a sizable portion, to help defray the immense cost of gun violence.

#### 28. WAITING PERIOD FOR RENTALS ON PISTOL RANGES •

It has been suggested in the past that felons can acquire pistols and other automatic weapons without a background check by renting a gun on a target range. Deranged individuals are basically being given a license to practice hunting humans at these so-called sporting ranges. We think that a national waiting period for gun rentals is yet another idea whose time has come.

#### 29. BANNING GUN SHOWS

30. BANNING OF MILITARY REENACTMENTS • The questionable "historical" value of these events has escaped public scrutiny for too long. Many of these so-called historical events are mere excuses for gun nuts to blast the countryside with automatic weapons. What is to keep them from loading live bullets and having those stray bullets kill innocent children? How many lives will be lost due to this paramilitary training going on right under our noses? We propose the prohibition of survivalist/paramilitary, World War I, World War II and Civil War Reenactments on federal land, and hope to encourage the states to prohibit them from state and county lands as well.

#### 31. MAKING UNLAWFUL THE ASSEMBLY OF MORE THAN 4 ARMED INDIVIDUALS

**WHO ARE NOT PEACE OFFICERS OR MILITARY** • Since most hunting parties consist of four, we recognize the need to eliminate the currently legal assembly of shooters for paramilitary training on private

lands. This is just one good suggestion for our elimination of the "gun culture" from the mainstream.

#### 32. BEGIN TO CURB HUNTING ON ALL PUBLIC LANDS

Blood sports are an anathema to a civilized society; however, it has been a political reality that hunters and their ilk have too strong of a hold on Congress. We feel that the impending defeat of high-tech "assault killing machines" will open the door to restrictions.

With the diminishing number of hunters, we feel that perhaps in five years we can open up much more of our country to campers and hikers, and eliminate the threat to families out camping, by looking at more restrictions as to what parcels of land will allow hunting. This will not infringe on sportsmen's rights to hunt on private land.

#### 33. MAKING GUN OWNERS' RECORDS AND PHOTOS PUBLIC RECORD •

We would have to assemble a legal team in order to investigate the balance of the right to privacy and the right to safeguard public. We fully endorse the photographing and fingerprinting of all gun owners, however, the records are usually relegated to law enforcement only. We think that it would be a

good idea to make these records public, so that the communities can have the knowledge of who poses a danger to their community before disaster strikes. We realize that this proposal would probably be controversial, thus a long public affairs campaign would have to be initiated in order to build public support and ease the transition of such an idea. We feel that this idea has merit, and can be justified via the past publication of the names of water wasters during the drought, customers for prostitu-

tion, and deadbeat parents who are delinquent on child support

34. RANDOM POLICE CHECKS FOR WEAPONS (LIKE SOBRIETY CHECKPOINTS) • Idea was floated before in California in 1989, where some thought it would be a great deterrent to gang-related crimes for police to do sweeps for gang weapons. Right now this idea may meet some resistance; however, the political climate can become right to initiate these random vehicle stops and checks at all levels and in all types of neighborhoods.

With all that is going on, who knows what is possible in the next few years? With murders in the streets, the public fed up, and the once mighty thugs of the gun lobby whimpering in impotence, we have an opportunity to change the face of America for the better!

Previously we thought that it would take at least a century to eliminate dangerous weapons and guns from public hands, but now with allies in the White House and Congress, we can accelerate this trend, and make the barbaric NRA extinct!!! Here are some ideas to consider for the long term:

BANNING OF MILITARY ACCOUTREMENTS • Essential to the Neanderthal gun culture are the typical military clothing, camouflage, pouches, boots and other combat gear. They euphemistically refer to this as "militaria." Elimination of the future sale of these items will cripple the culture of violence well into the 21st century.

STRICTER GUIDELINES FOR VIOLENCE IN TELEVISION AND MOVIES • We may have to eventually look at an independent branch of government to determine which scenes cause more harm than good to the public and regulate the numbers of violent acts portrayed.

THE TOTAL ELIMINATION OF ARMS FROM SOCIETY • We cannot survive into the 21st century unless we remember the need to expand our wave of new thinking to the total disarmament of America. With much of the public disarmed we can become more like Great Britain, where we can also eliminate the need for much of our police to be armed. This would take a long time,



however, a concerted public relations campaign can pressure local law enforcement to give up their arms when the time comes. Weapons would be available to special units like SWAT or the military.

### CONTROL OF DANGEROUS LITERATURE

Too much irresponsible material is covered by the 1st Amendment; however, the time will come when our nation has to agree that some literature does not belong in a safe society, like instruction manuals on how to kill, or how to make homemade explosives, or nuclear bombs. We must realize that there can be such as thing as too much freedom where such literature poses a serious threat to the public safety-

1994 sounds the death knell for the bully tactics of the NRA and the culture of violence in America!! We are pressing on all fronts and much of this can become reality sooner than we expect. With the loss of power and clout of the NRA and their various smaller crony organizations, we can eliminate a 200-year-old license to murder and enter the 21st century a safer place for our children and our children's children.

### Attachment 1 - Confidential Information for use by lobbyists or senior officers ONLY!

#### I. Proposed License Fees - 1994-1995 Gun Control Proposals

These listings and the documentation used to calculate these suggested fee schedules will be made available to federal law enforcement authorities and U.S. Department of the Treasury for review, when the time is right. Additional material will be made available to key politicians when proposing any fee-related legislation. These suggestions will be instrumental in determining the nature of future gun control legislation and proposals.

#### A) Handgun License Fees:

Year 1 to 2: \$50-\$75 annually.

Year 3 to 4: \$150-\$250 annually.

Year 5 to 8: \$550-\$625 annually.

#### B) Penalties for non-compliance:

- (1) failure to acquire license - \$1,000/6 months jail, revocation of ability to own;
- (2) failure to maintain license - \$5,000/12 months jail, revocation of ability to own;
- (3) failure to turn over guns for destruction after lapse of license - \$15,000/18 months

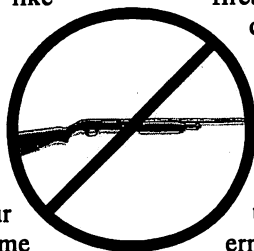

jail, revocation of ability to own.

Failure to renew license or notify issuing authority of change of status would be considered a felony. All firearms owned would be then considered contraband and confiscated. State or local authorities would be prohibited from retaining or reselling any confiscated firearms. Record of destruction to be issued to federal government not later than 60 days after confiscation.

### III. Estimate Of Fiscal Impact Of Licensing On Firearms Ownership:

	Worst Case	Best Case
Federal Handgun License:	\$50	\$625
Federal Rifle & Shotgun License:	\$30	\$148
State Gun License Fee:	\$74	\$150
Local Gun License Fee:	\$48	\$113
Arsenal License Fee:	\$300	\$1,000
Safe License Fee:	\$228	\$392
Ammunition License Fee:	\$55	\$117
Re-Loading License Fee:	\$130	\$175
Ammo Safe License Fee:	\$55	\$75
Ammo Inspection Fee:	\$588	\$678
Total Annual Cost:	\$1,558	\$3,473

This cost is not unreasonable, since it would offset considerably the estimated \$60 billion dollars in medical and social costs related to gun violence.

### IV. Reduction Of Gun Owner Population And Potential Yearly Revenue

The federal government estimates 65-75 million Americans own guns. These fees and the licensing requirements would allow us to take guns out of the hands of an estimated 30 million unsuitable or ineligible individuals. Fees for the remaining would reduce the number to about 14 million. Estimated revenue would constitute a minimum of \$21.8 trillion dollars (worst case) to an estimated \$48.6 trillion (best case) annually. Our eventual goal is to reduce the number of licensees to zero. The revenue itself can be utilized to achieve this goal.

### V. Possible Uses for the Revenue:

(A) Institute mandatory national, comprehensive educational campaign in schools (K-12) to deglamorize guns and gun ownership and tell the truth about the 2nd Amendment.

(B) A well-funded, concerted campaign to eliminate the 2nd Amendment via constitutional amendment.

(C) Provide revenue source for enforcement of new laws.

(D) Provide offsetting monetary fund for medical and legal services to victims of gun violence.

(E) Establish nationwide system of toll-free numbers for reporting violators of gun restrictions and non-licensees, a sum set aside for cash rewards for tips resulting in conviction.

Additional revenue sources listed:  
 Gun Related Activities: Range License: \$12,100 annually; Range Tax: \$85 per person, per visit; Gun Dealer License: \$600 annually; Title 1 Gun Manufacturing License: \$6,000 annually; Title 2 Gun Manufacturing License: \$13,400 annually.

Revenue calculations concerning the above fees will depend on how the numbers of gun ranges, gun range visitors, gun dealers and gun manufacturers are affected by increased fees. It is not unreasonable to predict a 40% drop by the end of the first year, another 35% drop the year after that.

### VI. Legal action and possible new revenue sources

Pending issues to be given at the appropriate time to the LCAV office for investigation as to feasibility, implementation and public reaction. At no time should these suggestions be made public before we can ascertain the current public reaction and provide the results of these studies to the LCAV attorneys.

There are some ideas which are ahead of their time and would only be feasible through a concerted PR campaign over time. A PR campaign includes press releases, press conferences, direct lobbying and constant pressure via the national media. We must change the way America thinks in regards to guns and gunowners in order to achieve a safe society for our children in the upcoming century. We realize that one cannot implement every good idea overnight, however, the following proposals have been forwarded for investigation as to possible enactment within

Continued on page 75

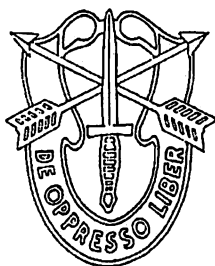

# Special Forces Involved In Waco Raid!

Text & Photo by James L. Pate

**George Washington** cautioned future generations against a standing army in peacetime. To Washington, the lesson of history was that if the military has no other enemy, it will eventually turn on the citizens by whose authority it exists.

The specter raised 200 years ago by Washington may, at last, be coming to haunt us.

As the social fabric of our nation frays, and traditions that have cloaked us in domestic security for generations gradually unravel, one of the patchwork solutions proposed is an increased military involvement in civilian law enforcement.

President Clinton was recently asked to muster troops to help beleaguered police in Washington, D.C. Drowning in a flood of illegal immigrants, the Border Patrol is moving closer to routine involvement of U.S. troops along the Mexican border.

But no issue has drawn the military into civilian law enforcement like "the war on drugs." Under that banner, the government has begun an orgy of seizures that make mockery of the supposed sanctity of private property and constitutional guarantees of reasonable search and seizure, and due process of law. Citizens are given assurances we must surrender a liberty here and a constitutional right there to regain domestic security.

While sifting the foul ashes of Waco, where power gone mad backed Lady Liberty into a corner and shot her in the head, *Soldier Of Fortune* has learned the "drug issue" may be more of a ruse than a reason for this march down the slippery slope toward martial law.

As the Waco trial slowly unfolded in federal court in San Antonio, testimony by Bureau of Alcohol, Tobacco and Firearms (ATF) agents — the gestapo of G-men — reluctantly revealed that ATF's raid training was

led by Army Special Forces. Reporters ran for the phones, and Army spokesmen confirmed involvement of Green Berets in training some 80 ATF agents, as part of final preparations for the bloody raid on the Branch Davidian's religious compound.

*SOF's* investigation, the results of which were shared with the *New York Daily News*, indicates Green Beret training for the ATF was far more involved than the Army will admit. Despite contrary claims, *SOF* learned through several interviews within the SpecOps community and Pentagon that Green Beret trainers violated their group's policy, and possibly federal law, with the type and scope of instruction provided the ATF.

Further increasing the official sensitivity over this ignominious incident are allegations that four Green Berets donned civvies and watched while their ATF protégés charged into the biggest disaster of American law-enforcement history.

Most disturbing, though, were revelations the training mission was not a rogue operation, but part of a sanctioned, ongoing program to more involve the military in civilian law enforcement, from federal agents down to Deputy Barney Fife.

The move began in 1989, when Congress approved a defense authorization bill directing the Pentagon to train and assist "to the maximum extent possible" civilian police engaged in drug interdiction. The law was partly a response to Defense Secretary Dick Cheney's earlier designation of drug trafficking as a national security threat. After the bill passed, Cheney announced activation of Joint Task Force Six [JTF-6] at Fort Bliss, Texas.

"JTF-6 support is intended to serve as a force multiplier to law enforcement agencies," states JTF-6's *Op-*

*erational Support Planning Guide*, obtained by *SOF*. It has "the potential to enhance [law enforcement] effectiveness or release significant resources to focus on [drug] interdiction/seizure actions... using a total force approach."

Located near JTF-6 headquarters is its civilian counterpart, Operation Alliance — a Justice Department entity accepting applications from civilian law enforcement agencies for military assistance in drug operations.

Although JTF-6's stated mission is drug interdiction, "the bottom line is that Operation Alliance will lie to JTF-6 [about drug allegations] in a heartbeat," said one DoD source familiar with the program. "The requesting agency, such as ATF, will tell Operation Alliance there's a drug angle — with a nudge and a wink — just to get what they want. And many times, JTF-6 doesn't even care."

The question of drugs in ATF's Waco investigation was raised early on. During ATF-FBI press conferences early in the 51-day standoff, four different press organizations, including *SOF* and *The New York Times*, asked: Was there suspicion of illegal drugs? Each time, the answer was no.

Two weeks later, when asked how ATF got permission to use National Guard helicopters, the story changed. Texas law requires evidence of illegal drugs before its aircraft are made available to federal agents. ATF spokesman David Troy, who later resigned when accused of lying about other aspects of the raid, suddenly recalled "evidence" of methamphetamine labs at Mount Carmel. Troy's claim was "made up out of whole cloth," said one ATF source in Texas.

In the subsequent trial, not one shred of evidence of illegal drugs was

introduced. Conversely, in a society where drugs are common, it is notable that toxicology tests on the remains of 81 Davidians who died in the 19 April holocaust revealed *not one body with a trace of illegal drugs.*

Even when drugs are involved in civilian law enforcement operations seeking military assistance, the law is murky on how far the military can go.

The JTF-6 planning guide states military forces "are precluded by the Posse Comitatus Act from performing search, seizure, arrest or other similar law enforcement activities." It then outlines which types of assistance it can and cannot provide, but notes ominously that "no list of military support capabilities is ever all-inclusive..."

Under "Political Sensitivities," the guidebook advises "employment of military force in such a way as to avoid any potential confrontation with the civilian populace ... Many operations are inherently sensitive and involve various risks which may be heightened by the release of information to the public."

Sources interviewed by *SOF* said both Operation Alliance and JTF-6 keep legal staffs busy, primarily finding legal loopholes to allow further military involvement in civilian law enforcement. The JTF-6 handbook acknowledges that in a roundabout fashion:

"Innovative approaches to providing new and more effective support to [law enforcement agencies] are constantly sought," the operational planning guide says, "and legal and policy barriers to the application of military capabilities are gradually being eliminated ... Pending legislative actions may soon alleviate some of these restrictions..."

Houston attorney Mike DeGeurin, defending one Davidian, got everyone's attention when he asked a government witness if he recognized any of five names that DeGeurin implied were present when Mount Carmel was raided.

Fort Bragg's personnel locator service confirmed that the five men listed



**Hargrove MOUT (Military Ops in Urban Terrain) facility at Ft. Hood, where Green Berets trained BATF agents before their disastrous raid near Waco. Military investigators are now looking into allegations that ATF training violated SF policy and/or federal law.**

XO); and battalion members Sergeant First Class Chris Dunn, Sgt. 1st Class Greg Handy, Staff Sergeant Jon F. Wilson and SSgt. Cordell W. Ackley.

*SOF* sources indicate the Mobile Training Team (MTT) meeting ATF's Waco raid contingent at Fort Hood also included Captain Clyde Moore (designated team commander), SSgt. Michael J. Dooney, SSgt. Steven M. Fitts, SSgt. Jay C. Burkhardt and SSgt. Robert R. Moreland — all of Company B, 3rd Battalion, 3rd SFG.

The 10 were among a company of Green Berets deployed in January 1993 from Fort Bragg to McGregor Range, New Mexico, a remote part of Fort Bliss. The Bragg-based troops were assigned a 90-day stint with the Rapid Support Unit (RSU) which responds to short-fuse requirements generated by JTF-6.

Once a civilian agency like ATF requests military assistance from Operation Alliance, the request goes to JTF-6, which has legal and public-affairs support. If the request passes muster, JTF-6 issues a mission order to the RSU, which assigns men to the task. Before deployment, however, a green light must come from Forces Command (FORSCOM). Then, the MTT deploys to a training site to meet the civilian lawmen it will train.

Mission JT002E resulted in an operational detachment from 3rd Battalion, 3rd SFG, deploying to Fort Hood to train ATF. On 16 February

by DeGeurin in court are members of the 3rd Battalion, 3rd Special Forces Group, headquartered at Fort Bragg as part of the U.S. Army Special Operations Command: Major Mark Petree (3rd Battalion

1993, Handy, Dunn and Ackley left Fort Bliss for Fort Hood to survey training sites. Next day, they met with Hood's range control office to secure use of Hargrove MOUT (Military Operations Urban Terrain) Training Center. They also met with ATF agents Kenneth King and Bill Buford, team leaders of Special Response Units assigned to execute forced entries through second-floor windows at Mount Carmel.

(King and Buford were both gravely wounded in the Waco raid; with Buford and another of his team probably hit by misdirected fire from ATF agent Keith Constantine, trial testimony indicated. Three members of their SRU teams — Conway C. LeBleu, Todd W. McKeehan and Robert J. Williams — were killed.)

Handy, Dunn and Ackley returned to McGregor Range 19 February. The entire detachment returned to Hood 22 February. Dunn and Wilson, two of the Green Berets who would later watch the disastrous ATF raid at Mount Carmel, went to meet ATF point-of-contact, agent Kris Mayfield.

The Green Berets and the approximately 80 ATF agents who would ultimately arrive were billeted in the bottom floor of Building 4424, the top floor of Building 4426, and Building 4462, Fort Hood sources said.

The following day, some Green Berets went with Mayfield to the Hargrove MOUT site and took measurements to

build a front-door mock-up of Mount Carmel. Mayfield accompanied Dooney, Burkhardt and Wilson to McCoy's Building Supply in Killeen for materials.

By 24 February, all ATF personnel, including raid leaders Charles Sarabyn, Phil Chojnacki (both now fired) and Ted Royster arrived. XO Petree flew commercial to Killeen, where

he was met by two members of the detachment. It was a mystery why a major would come to super-



**Joint Task Force Six logo, the multi-agency rent-a-troop instrument designed to provide military resources to civilian law enforcement in the war on drugs.**

*Continued on page 75*

# TERMINATE

With  
Extreme  
Prejudice

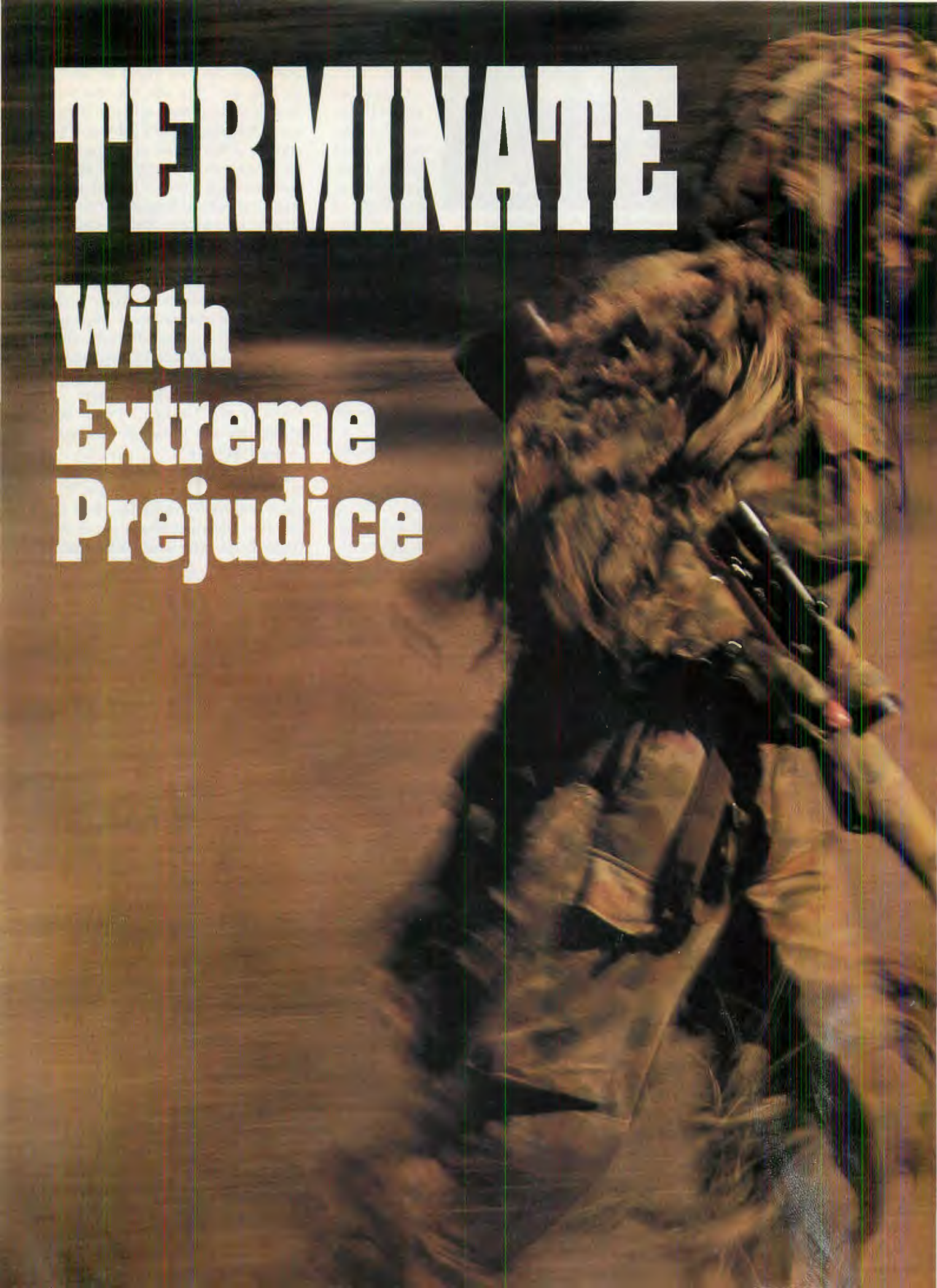



Practice range features man-size targets at varying ranges. Color-coding allows instructors to test trainees range gauging skills.



6x42 Kahles Helia ZF 69 telescopic sight with cross-hair reticle pattern is the standard issue scope for Australian army snipers.

*Snipers are one of the most maligned of all military occupations. Because they operate alone or in pairs, and are usually under direct command of the commanding officer, they are simultaneously glorified and resented by their own infantry. To the enemy, their work is considered cowardly, criminal and murderous, even in times of war.*

*Part of the malice snipers attract is due to their ability to take down anyone, regardless of rank. Evidently, during the American Revolution — the war that gave birth to sniping — an English sniper took a bead on the back of an American general's head. Because the general had his back turned, the Englishman let chivalry prevail and didn't pull the trigger. That general was George Washington.*

**Cameron “Yogi Bear” Innes is 19 years old.** If it wasn't for the huge brown knife strapped to his waist, the camouflaged uniform and the high-powered rifle in his hands, Yogi could be your average teenager. But Yogi isn't

---

## **Aussie Snipers Take Aim Down Under**

**by Todd Cole**

**Photos by Paul McIver**



**Left and Top: Every Aussie sniper individualizes his "yowie" suit and scoped Parker Hale Model 82 rifle to his own specs.**



**Sniper trainee uses his non-standard issue Rambo knife to clear brush for sniper hide. Maintaining concealment while spotting a concealed enemy are fundamental sniper tactics.**

your average teenager, he's a trainee sniper in the Australian army. And he's being trained to stalk and kill men from distances up to 1000 meters. He's just shot a bull's-eye at 800 meters — a remarkable shot in anyone's book and struts around like he's just won the lottery, full of bluster and disbelief. One of the instructors, Warrant Officer Sugg, bets him a rum and coke he can't do it again. Yogi lays down on the computerized firing range and squeezes off another shot. He stands up and says to Sugg, "So do you want that in a middie or a schooner?"

The average age of a sniper trainee in the Australian army is 21 and these men are a select group. To simply attempt the sniper course they have undergone a pre-selection at their battalion, often outdoing 20 or more candidates. Now they compete among 20 other candidates in a six-week intensive course with a failure rate often approaching 50% to become a sniper. Why?

"Most of them want the badge, the crossed rifles of a sniper, on their uniform," explained Sugg.

"Being a sniper is a stepping stone to the Special Air Service," noted

**During concealment exercise this sniper trainee awaits opportunity to "shoot" his instructor with a blank and thereby "win" the round.**



one trainee who refused to give his name.

"I'd like to be in the Special Police Group when I get out. I figure this will help," added another.

"I'm doing it for myself — for the challenge," said a man who is doing the course for the second time.

Their reasons are as individual as they are — and individual they are. Their operating uniforms, called "yowie" suits (Ghillie suits in the United States), are custom-made by each individual by sewing AUSpat camo — the camouflage uniform worn by the Australian army and designed specifically for the Australian bush — with torn hessian.

The yowie suit's purpose is to



**Trainee practices stalking. Described by participants as playing cat and mouse — except the mouse has a gun.**

break up the outline of the sniper from his prey. But seen all together, they are fashion statements. Leather gangland-style mittens, baseball caps (camouflaged, of course), and unique camouflage makeup all work to personalize each trainee.

But hold on, isn't this the army? Isn't "self" a four-letter word?

"A sniper must be able to operate

effectively by himself, so we don't discourage a certain amount of individuality. In fact that's the hardest part of the training," said Sugg. "These guys have been trained to operate as part of a big team for a couple of years. We have to partly remove that instinct and get them to think for themselves before they become effective as snipers."

The most individual part of the sniper is his weapon. The Australian army uses Parker Hale Model 82 7.62x51mm bolt-action rifles — a target rifle by design — mounting a 6x42 Kahles Helia ZF 69 telescopic sight with a cross-hair reticle pattern. It is an old weapon, first introduced in 1979, that has a hard time handling the rigorous conditions

imposed on it by sniping.

But soon, the sniping cell is told, the bureaucratic wheels will grind into motion and they will have a more practical weapon. Trials begin this year.

One interesting idea being considered is the introduction of a .50-caliber sniper rifle. The Parker Hale is to the .50 caliber, what a Chinese arm burn is to a kick in the nuts. One of the primary advantages of a .50-caliber bullet, which is a derivative of the round used by the Browning heavy machine gun, is that it has a flat, even trajectory. A .50-caliber rifle can hit a target at 1500 meters accurately, while the Parker Hale can only reach 800 meters with effective accuracy. A rifle with such distance would be ideal for dominating areas of open bushy plains, with only moderate cover — like much of the terrain in Australia.

The .50-caliber round is the size of two rolls of nickels stacked on top of each other and can penetrate the armor of most armored personnel carriers. What it does to the human body doesn't need describing.

But for the time being, trainee snipers carry the standard issue Parker Hale — not that it looks issue after each individual has personalized his weapon.

### How To Eliminate The Target

The first five weeks at sniper school are a repetitive grind to learn the six basic skills of sniping. First they practice camouflage and concealment. They conceal themselves in the bush in a given area and an instructor sits a distance away and tries to locate them with binoculars. If he can't, they can shoot him with a blank. If he still can't see them, they shoot again and then identify a number card, just to prove they aren't cheating. If they get the number correct, they've won.

Second, they judge distance from 100 to 1000 meters — self explanatory really, but a lot more difficult than it sounds. This is important for setting the range on their sights. One hundred meters off in judging distance over 500 meters and you're 10 centimeters off your target — a miss if you're aiming at someone's head.

Third, they practice observation. Objects are placed in a given arc and the snipers scour the landscape for them with a telescope. Sound easy? It's not. Pens are put in trees. Camouflage can-

teens are hidden in deep, long grass. "A sniper must learn to look for the unusual," said one of the instructors. "This is paramount because a great portion of their time is spent watching and gathering information."

Then they hone the navigation skills learned in the infantry. Should the day come when these guys are shooting for real on the two-way range, they must know where their target is and where they are. Later

It works the other way too. "Occasionally, some guy looks hopeless all the way through and then, on the day, he pulls it out of the bag. It's unusual, but some people handle pressure better than others."

The pressure shows. Ideally, a sniper must be a non-smoker. But when these trainee snipers come back from a two-hour stalk, most of them light-up, and then light another off the burning butt as they stand around



Sniper and spotter practice on target range. Monitor shows exact location of hits.

they must stalk the instructors. Stalking is essentially the culmination of all the skills into one exercise. It's really a game of cat and mouse, but the mouse has a gun.

The trainees are told to locate and eliminate a target — an instructor. If the failure rate of the stalks that I saw is any indication — about 80% — this is a very difficult exercise.

Lastly, shooting is practiced. Surprisingly, this skill is held as the least difficult to achieve. There's a saying that goes: All snipers are good shots, but all good shots are not snipers.

### One Moment Of Truth

After five and a half weeks of this, the snipers are tested for the coveted crossed rifles badge. It all comes down to one moment of truth, much like it would in reality.

"We've seen guys come in and do great all the way through the course," said Sugg, "and on the big day they fuck up big time. It's the pressure. But that's a part of the job."

in solemn deliberation.

Many snipers are from the country and have grown up with guns and the bush. Yet it's not unusual for a city bloke whose only hunting experience has been in nightclubs to excel on the course.

It's difficult to distill the essential personal attribute down to one quality. The army toes the party line citing intelligence, field-craft, fitness ... blah ... blah ... blah. But it was one of the soldiers in the back of an army truck bouncing along a road in the middle of nowhere at 0800 who gave the best indication of what it really takes to be a sniper. He was 19; the night before he'd been "socializing" until 0200.

So what's it take to be a sniper? "I don't know," he said looking off into the middle distance, "but whatever it is, I'm going to find it. If not this year, then the next. I'll find it."

*Todd Cole is a senior editor at the Australian edition of Penthouse magazine. Paul McIver is a freelance photo journalist. ✕*



# JUDGMENT DAY: THE WACO TRIAL

by James L. Pate

**The 51-day debacle** outside Waco, Texas, last year began and ended with unbelievable violence. Many saw it as a battle between good and evil. But which was which? That was the question a U.S. District Court jury in San Antonio began deliberating in February.

It started one Sunday morning with a hellish gunfight in a cold winter rain. Zealous devotees of a self-styled messiah shot it out with the decidedly secular, but no less ardent forces of earthly rule. Killed in the crossfire were six true believers of an apocalyptic sect that call themselves Branch Davidians and four agents serving the supposedly omnipotent U.S. Department of the Treasury. They fought toe to toe on the line between interpreting God's law and rendering unto Caesar a federal firearms tax.

The tragedy ended with even greater drama, on a spring Monday about high noon. Prairie wildflowers were crushed by tanks that assailed the walls of the religious refuge and belched poisonous clouds of gas inside. Fire broke out; clouds of smoke from the raging pyre reached hundreds of feet heavenward, consuming at least 81 people, most of them women and children — sooty smoke that blackened the integrity of a government which holds itself up as a beacon of integrity in a world darkened by oppression.

A 10-count indictment charged 12 surviving Davidians with federal firearms violations, conspiracy to kill the four Bureau of Alcohol, Tobacco and Firearms (ATF) agents who died in the raid, and with their actual murders.

To find any defendant guilty of conspiracy, jurors must unanimously decide beyond a reasonable doubt four factors: (1) Two or more defendants agreed to murder the ATF agents; (2) the defendant knew the agreement was unlawful and willingly participated; (3) at least one conspirator committed at least one of six "overt acts" listed in the indictment; and (4) there was premeditation.

Three defendants not present at the raid — Paul Fatta, Woodrow Kendrick and Norman Allison — could be found guilty of conspiracy if the jury found they were responsible beyond a reasonable doubt for any substantive offense committed by a co-conspirator: for example, making available a firearm, knowing it would be used for a criminal act.

Jury selection set a tone for the rest of the trial, namely one of public intimidation, which implied the government had much to hide. U.S. District Judge Walter S. Smith Jr., himself just cleared by Justice Department investigators of an allegation he gave perjured testimony against a

political opponent in a civil trial three years ago, ruled that jurors' identities would remain secret.

One San Antonio resident who objected, insisting she be admitted to a public trial in a public building, was arrested by U.S. marshals. Kelley Shannon, an Associated Press reporter, witnessed the arrest and remarked casually that "it is a public building." A marshal who overheard her comment forced Shannon to leave, plus a *Houston Chronicle* reporter who happened to be nearby. John Lumpkin, Texas bureau chief for AP, filed a protest with the judge, complaining that "from the beginning, federal authorities have ... inhibit(ed) the free flow of information."

During trial, Smith, an imperious, ill-tempered man with baggy eyes and a perpetually flushed face, ran the courtroom like a petty dictator. While Smith, marshals and prosecutors routinely chewed gum and sucked hard candy, such treats were taboo for others. Whispering to each other via microphones hidden in their shirt sleeves, courtroom marshals were ever vigilant against gum-chewers and slouchers. Another AP reporter, Jean Pagel, was made to spit out her Juicy Fruit, and Dick J. Reavis, of *Texas Monthly*, was threatened with expulsion for "undignified posture." Another reporter, believed (incorrectly) to have stiffed San Antonio on a parking ticket, was handcuffed exiting the courtroom.

In the opening day-and-a-half of testimony — so monotonous it threatened to put jurors to sleep and thinned



the ranks of reporters from as far away as Europe and Australia — prosecutors introduced more than 200 firearms. These included 48 automatic weapons, mostly AR-15s and AK-47s, alleged to have been illegally converted.

Davidian leader David Koresh did not survive to face an earthly judgment. Of his 12 disciples originally charged, only one turned state's evidence. But star government witness Kathryn Schroeder was not the Judas that many — including prosecutors — had expected. She threaded her way through two days of testimony without seriously incriminating any of the 11 remaining defendants. Like

tory, some of it plainly helpful to the defense. Notable by their absence as witnesses were ATF agents Davy Aguilera, who headed the original investigation, and Phil Chojnacki and Chuck Sarabyn, who commanded the botched raid and were ultimately suspended for lying about their mistakes. Nor was testimony heard from FBI agents Jeffrey Jamar, in charge of the standoff, or Dick Rogers, former head of the Hostage Rescue Team, whose precipitous action resulted in the final inferno.

Convincing testimony was heard that some Davidians discussed an act of collective suicide during the first week of the siege, a plan called off. Compelling evidence also shows some Davidians spread fuel around Mount Carmel on the final day. But that same evidence — conversations picked up by FBI eavesdropping devices — suggested that this final act was not suicidal, but a desperate defensive tactic aimed at setting the government tanks ablaze.

Unlike the government, which rallied a lackluster presentation by finishing with a flourish of electronic surveillance evidence, the defense surprised spectators with a disappointing anticlimax. The 16 defense attorneys rested their case after calling only eight witnesses.

Strained by weeks of successfully countering everything the government threw at them, the unity of the defense team unraveled as their day in court approached. Meeting with clients in the Bexar County Jail the night before they were to begin presenting their case, the defense team split along several lines. Some wanted to rest, others wanted a protracted defense. Norman Allison, against whom there was little evidence, wanted to personally deny charges against himself. Livingston Fagan, identified in court by ATF agent Eric Evers as the man who'd shot Evers, felt he had nothing to lose by testifying.

To the dismay of several colleagues, Allison's attorney, Tim Evans, said he intended to have his client testify. Allison, a British rap-music artist in Texas visiting a friend, Derek Lovelock, was not a Branch Davidian, but a hapless traveler in the wrong place at the wrong time. He had been sleeping in the Mag Bag, an automotive garage four miles from Mount Carmel. Allison surrendered to ATF agents in the woods behind the complex, hours after the shoot-out. An agent testified the .22-caliber pistol found in Allison's pocket, zipped in a leather pouch, was unfired. Moments before walking into court, Evans changed his mind and decided not to call Allison, calling it "the most difficult decision I've had to make..."

The decision to call it quits after a day-and-a-half of defense testimony "was the effect of a group trial wherein none of the defendants could safely take the stand without endangering one of the other defendants," one unidentified defense attorney told *The New York Times*. "We could not present our ... position, which [was] not that bad."

The defense team did put before the four-man, eight-woman jury several key facts: ATF's case agent, Davy Aguilera, who made himself most useful during the trial by running the prosecution's overhead projector, had refused an opportunity to meet with Koresh seven months before the raid. Koresh had voluntarily provided information for firearms records being examined by the ATF on 4 August 1992. The defense also countered government claims the raid was necessary because Koresh allegedly would not leave Mount Carmel, by presenting testimony



Protesters outside federal building in San Antonio, first day of Davidian trial. Photo: Rick Hunter

In a stunning defeat for the Justice Department, jurors in the Waco case acquitted all 11 Branch Davidian defendants of murder and conspiracy charges, which carry a mandatory life sentence without parole. These charges were the linchpin of the government's shaky case. Four defendants — Norman Allison, Ruth Riddle, Woodrow Kendrick and Clive Doyle — were acquitted of all charges. At press time, prosecutors had filed a motion to reinstate charges against Riddle, effectively blocking her return to Canada.

Five Branch Davidians — Livingston Fagan, Brad Branch, Jaime Castillo, Kevin Whitecliff and Renos Avraam — were found guilty of aiding and abetting voluntary manslaughter. To reach that verdict, jurors had to find that the five were provoked by federal agents and reacted in the heat of passion. Paul Fatta was found guilty of two federal firearms charges related to the illegal conversion of machine guns. Finally, Graeme Craddock was found guilty of possessing a hand grenade.

several other prosecution witnesses, including two ATF agents and two other Branch Davidians, she provided testimony indicating that ATF agents fired first (and recklessly), forcing Davidians to defend themselves.

The feds ultimately spent six weeks calling 125 witnesses, dozens of them gun and surplus dealers, not one of whom provided a single shred of evidence about an illegal purchase. At every opportunity, though, prosecutors implied something sinister about paying for purchases with cash. Much of the government testimony was contradic-



ATF agent Roland Ballesteros, left, was assigned to be "first through the door" during raid at Mount Carmel. Photo: Rick Hunter

he made business trips into Waco and elsewhere in the days just before ATF stormed the complex. Finally, there was strong evidence — part of it from a key government witness — that the Davidians' home was fired on from helicopters.

*Texas Ranger Captain David A. Byrnes:* He was in charge of the Texas Rangers

who processed the scene after the fire. Actions by the FBI during the 51-day siege were "obviously altering outside evidence ... I disagreed with that." (According to a Justice Department report citing Byrnes, "the Rangers' relationship with the FBI command post deteriorated rapidly. Numerous Rangers complained to him that FBI agent Jamar and others in the command post treated them rudely. The Rangers eventually pulled out of what they considered a hostile atmosphere ... Captain Byrnes said the incidents with Jamar and the FBI at Waco severely strained the relationship between the FBI and the Texas Department of Public Safety. He added that ... hard feelings would linger.")

On the witness stand, Byrnes also acknowledged the exclusion of ATF agents from the scene because "there had been some concern that people would think there had been a cover-up ... if the ATF was down there," and that ATF agents "might salt the scene" with bogus evidence. He acknowledged on cross-examination there were "a couple of hours" between the fire and when the Texas Rangers took control of the scene, during which time FBI and ATF agents "could have had access."

*Texas Ranger Sergeant Fred*

*Cummings:* Cummings inadvertently revealed that half of Mount Carmel's double front-door was missing — the half that had been publicly identified by one defense attorney as a key piece of evidence because the "spray pattern" of entry holes confirmed Koresh's assertion that one agent fired a burst of machine gun fire at him as he tried to talk to agents. Cummings also told defense attorney Jeff Kearney that "trash" was loaded into a dumpster by FBI agents even as the Rangers continued to process the scene for evidence.

*FBI agent James Cadigan:* The Davidians had completed 22 sound suppressors, according to evidence processed by Cadigan at the FBI's firearms laboratory. He acknowledged that of all the burned machine guns he examined, he could not say any of them had been used

against agents in the raid — or had ever been fired at all. He said 22 AR-15s, 20 AK-47s, two H&K SP-89s and two MAC-11s had been modified for full-auto fire.

*ATF agent Roland Ballesteros:* ATF's policy on knock-and-announce search warrants is that agents must knock and wait "a reasonable amount of time" to be permitted entry. Ballesteros testified, "The contingency plan was that if we received gunfire, we were to leave," but also testified on direct examination that he was told if he heard gunfire, "don't react to that." Assigned to "be the first one through that front door," he testified he heard shooting before he got there, but said he heard the first shots "to my left," where agents were piling out of two cattle trailers. The front of the building was to his right.

Ballesteros said he saw Koresh standing in the open door as he charged through the front gate with a Winchester 12-gauge pump shotgun at the ready, and that Koresh and two other people standing next to Koresh did not have weapons visible. "I looked up and yelled, 'Police! Lay down!' I yelled it pretty loudly. I yelled, 'Search warrant!' a couple of times. I kept running toward the front door. [Koresh] responded, 'What's going on?' I yelled, 'Search warrant! Lay down!'"

In cross-examination, Ballesteros admitted that in his statement to Texas Rangers 10 days after the raid, and in a preliminary hearing last fall, he made no mention of anyone yelling anything about police or a search warrant. His

first two accounts of the raid indicated his belief that the first shots were fired by ATF, probably by a team assigned to shoot dogs. (In an example of the contradictory testimony given by government witnesses, a three-man ATF team had been assigned to "neutralize" a bitch with four pups. At least one dog was found dead — and two different agents took credit for the kill. But dog-team members said they never shot a canine.)

Ballesteros said his front-door entry was rehearsed "two or three times" at Fort Hood. "No, we did not" practice a peaceful entry, he

said. "I was just instructed to enter that front door ... We'd hoped they'd surrender. Hopefully, they'd see who we were and do as we said ... [Sarabyn] did tell us, 'They know we're coming, let's hurry.' I did not worry about the loss of surprise. My adrenaline was pumping..."

Insisting the agents were "ambushed," Ballesteros was asked if he did not think it would be odd for Koresh to open the front door unarmed and initiate dialogue if people inside were already shooting. "No, it wouldn't be odd," he replied.

*ATF agent Eric Evers:* He was the second government witness to change his story about who fired first. Like Ballesteros, Evers told Texas Rangers in a tape-recorded statement made right after the shooting that the first shots he heard came from a member of the dog team.



ATF agent Davy Aguilera, left, who headed ATF's investigation leading to Waco raid, had so many credibility problems Assistant U.S. Attorney Bill Johnston, right, didn't dare call him as witness. Photo: James L. Pate



U.S. District Judge Walter Smith Jr. of Waco, left, and Assistant U.S. Attorney Bill Johnston, at U.S. courthouse in San Antonio. Smith ran the courtroom like Ferdinand Marcos ran the Philippines; his disdain for the defense team was thinly disguised. Photo: James L. Pate

in the wrist and right shoulder, he said he saw defendant Livingston Fagan shoot him as he rounded the north rear corner of Mount Carmel. On cross-examination, though, he admitted that he looked up after being hit and saw "a black male." In two subsequent statements, he did not claim to be able to identify the person who shot him. It was only after Fagan — one of 15 black males living at Mount Carmel, but the only one to exit during the stand-off — was seen on CNN that he was able to accuse Fagan.

It was during Evers' testimony that the first of several failures by the prosecution to turn over to defense attorneys key evidence came to light. A photo lineup shown to Evers — one the defense had not been shown — was handed over in court by Texas Ranger Sgt. Ray Cano, with the remark that "right is right." On the photo spread, next to Fagan's picture, Evers had written and initialed the comment that he was "unsure

In court, though, he testified the Davidians "ambushed" the ATF. Evers also admitted that Sarabyn warned that the Davidians knew the ATF was coming and that they had to hurry. Although he claimed to be surprised to see news media present at the raid site, he admitted the code word for going ahead with the raid was "Show time!"

Evers' testimony was important for two key reasons. Wounded

if I.D. is from TV or memory."

**ATF agent Dan Curtis:** Testified he could hear rounds fired by ATF snipers whickering overhead during the gunfight. He wept as he described the death of fellow agent Steve Willis, who was crouched behind the truck, facing the building when "I saw him jerk forward." The testimony suggests Willis may have been struck from the rear by ATF sniper fire.

**ATF agent Kris Mayfield:** One of several ATF agents who admitted he "had very little ammunition left" after the raid. He saw ATF agent Robert Williams killed as Williams faced the building, crouched behind an old safe: "His head jerked backward and he fell to the ground on his back." Mayfield's wife is an ATF agent, who was also on the raid.

**ATF agent Samuel Cohen:** Before he could get out of the trailer, Cohen said he heard fire from an MP-5 submachine gun and 9mm pistols — weapons carried by ATF agents. As he exited the rear of the trailer,

a .223 bullet struck his side arm. He told Texas Rangers after the raid that the first thing he saw on exiting the cattle trailer was the backs of ATF agents already shooting. Like other agents, Cohen said he could hear incoming ATF sniper fire overhead.

**ATF agent Kenny King:** King, who had never drawn or fired his weapon at a hostile target during 21 years in the ATF, was leader of one of two teams assigned to force their way into Mount Carmel through second-story windows. "Immediately after exiting the trailer, I heard gunfire," King testified. King said he headed for the side of Mount Carmel with his team and a ladder. Once on the roof, two members of King's entry team — Conway LeBleu and Todd McKeehan — were killed. King was shot six times. Three bullets are still in his body. He nearly died after rolling off the roof, unseen for more than two hours, pleading into his radio for help. "I was determined I was not going to die there," he said, "laying there" listening to blood from McKeehan's head drip off the roof "like rain." A white-haired



Houston attorney Mike DeGeurin, who defended Davidian Paul Fatta (not present during Mount Carmel raid) on charges he conspired with leader David Koresh to buy guns and convert them to full-auto for confrontation with feds. DeGeurin's brother, Dick DeGuerin, was Koresh's attorney until Koresh died in fire ending 51-day siege. Photo: James L. Pate

Rented building of Mag Bag, David Koresh's auto repair business, deliberately wrecked by ATF agents in Bradley fighting vehicle. Building's owner, banker Gary Welch, stood by with keys in hand, begging agents not to destroy his property. When he objected, he was arrested. Photo: James L. Pate



Continued on page 76

**Will Election Trigger  
Racial and Tribal  
Warfare?**



Photo: Henner Frankfeld/WYT PIX

# **SOUTH AFRICA'S BLACK HORIZON**

**by Al J. Venter**

**South Africa** is making history. Its all-white political establishment is about to be swept into oblivion by a general election that even optimistic observers fear will throw the country into ravaging turmoil. The outcome could be full-scale civil war, comparable perhaps to Bosnia — or even worse, because its impetus could be fueled by black-white racial hatred.

There are optimists, of course. Good potential exists in a country regarded, even by its detractors, as the most powerful economic power in Africa and one that has been blessed with a plethora of natural resources.

But that would disregard the fact that everyday violence in South Africa equals, or even surpasses, that of Yugoslavia on a bad day. Or that unemployment is nudging 50%, or that the majority of blacks in South Africa do not understand the basics of democracy, or even the vote.

Couple this witches' brew with a level of racial hatred that, as the Human Rights Commission stated in issuing its latest casualty figures, left 4,364 dead in political violence last year, and at least 14,000 people dead as a result of political differences since President F.W. de Klerk began dismantling apartheid four years ago, and the future looks bleak.

The scenario began with the release of Nelson Mandela, leader of the African National Congress (ANC), who is expected to be the

next president. Even the most sanguine observer would expect an ANC election victory, but Mandela and his followers do not have it all. The ANC is opposed by most South African whites, some 5 million strong and almost all armed, and by a majority of the 6 million Zulus.

Together, these are a minority in a community of about 35 million souls, but one with powerful clout, largely because whites still dominate the armed forces and South African Police, and history has shown that the Zulu nation is not one to trifle with. Add to that the fact white South Africans have recently emerged from a two-decade guerrilla war and have much military experience behind them.

Issues have become even more serious since de Klerk was warned in a meeting with his chiefs of staff in late January that if the violence continues to escalate, the army and the police "cannot and will not be expected to stand idly by." If this "threat" is not construed as a warning of some form of military rule, short of an outright *coup d'etat*, then one might well ask: What more does it need? Certainly, more effective rule of law is the most pressing need of South Africa, and is foremost in the minds of the majority of its citizens, black or white.

In recent months, numerous international observers have visited South Africa and the parallels with Bosnia and Georgia, or the violence in Afghanistan and Armenia has not been lost on them.

Similar circumstances prevail: the breakup of an established political system; ethnic dominance by one group that is better armed and equipped over another; real or imagined political grievances and, of course, the devastating racial issue that permeates all levels of society including schools, hospitals and social services as well as urban, regional and national government.

Outside the debating chamber, blacks and whites simply do not listen to each other. You need no better illustration to comprehend this hostility than to drive on the country's roads. Blacks and whites compete for space and distance at the wheel of their cars, with a vengeance that has resulted in South Africa having the highest road accident death rate in the world; *more than 700*

*killed during the last December holidays alone!*

Numerous factors have contributed to the breakdown of the political system in South Africa. Certainly, the South African government itself has played a crucial role in creating a climate of instability, at a time when strong action would have been a more appropriate answer to the nation's ills. In short, government in South Africa has lacked a coherent direction or genuine impact.

Decisions at cabinet level vary according to the moment. Increases on fuel or food taxes are made one day and withdrawn the next. Huge financial scams involving government departments are unraveled weekly — hardly the climate to inspire confidence, which is one reason why de Klerk (often compared to Gorbachev), though popular abroad, is reviled by many of every shade of the political spectrum at home.

Internal security is another example. Consistently, Mandela's ANC has berated security forces either for, or for not, taking a more active part in limiting violence, depending on the mood or circumstances. Each time a brutality occurs, ANC spokespeople lash out at the police or army, depending upon who may be present or in the area at the time. If the police were not in the area where a particularly horrific event, such as a multiple township shooting, occurred, they are accused of partiality, or of "inability or unwillingness" to react. If they *were* present, the cry goes out for them to be removed immediately. As one observer noted, the ANC speaks with many tongues, and evidences a lack of coordination at the highest levels.

A case in point is the ANC march on Bisho, the capital of Ciskei, in the eastern cape, scene of much recent violence. A year ago, the Ciskei army opened fire on marchers. There were numerous casualties, including some deaths. South African security forces had been warned by the ANC before

the event that the march had nothing to do with them, so they let the column of protesters pass. Once the shooting started there were bitter re-priminations about the "lack of police or army protection." Simply put, it is a no-win situation.

Another example is the internal security unit *Koevoet* that had previously seen brilliant service in the war against Swapo in South West Africa/Namibia. A peace treaty having been signed (and Namibia newly independent), *Koevoet* was relocated to South Africa and deployed in a bid to limit township violence. They were remarkably effective: Tough, well-



Zulu Inkatha Freedom Party supporters with traditional weapons, poised for battle in Johannesburg suburb of Soweto, during black-on-black violence between Zulu and Xhosa. Photo: AP/ Wide World

trained and disciplined, the unit brokered little nonsense from various dissident factions. Typically, their very presence limited violence.

This was not good enough for the ANC. Backed by South Africa's English newspapers, Mandela and his associates campaigned hard to have *Koevoet* elements withdrawn from the townships and disbanded. President de Klerk conceded: *Koevoet* became history and the level of violence, in areas where the unit had been active, spiralled.

It would be simplistic to define the current violence in South Africa in tribal terms. Basically though, the thrust of the "struggle" is linked to strong differences between the Inkatha Freedom Party — IFP (which is a Zulu, tribally orientated movement) and the ANC (which has always had its origins among the Xhosa people of the eastern cape).

While the ANC commands support from elements within all racial groups and tribal allegiances, its main strength lies in the Transkei,

Mandela's "homeland." In fact, the ANC's strongest military backing comes from General Bantu Holomisa, the Transkei military leader. Many of its office holders are Xhosas, although the ANC also has many followers who are of European, Asian and Zulu extraction. There are ANC card carriers in every one of South Africa's other tribes.

While that situation holds at present, critical observers are asking: What about tomorrow? The ANC has succeeded, brilliantly, in acting as an anti-South African catalyst for dozens of movements and organizations who have been, or still are, opposed to the South African government. But to most it has been an alliance of convenience. Judging by the fact that Mandela is no longer in prison and that universal suffrage elections are imminent, this "alliance" has been very successful.

But the coalition ignores one paramount constraint and one which is

Anyone who has observed recent developments is also aware that tribalism (ergo, tribal warfare) is the single biggest catastrophe facing independent black African states at the present time — from South Africa to the Sahara.

Currently, there is an ongoing tribal war in Burundi that has left several hundred thousand dead, and produced half a million refugees. Internal warfare is ongoing in Liberia, where the brutality has been even more severe. Most young people have never heard of Biafra, but that Nigerian civil war — between the Ibo tribes of the east, the western-region Yorubas and the Moslem Hausas of the north, ended with roughly 1 million dead, give or take a couple hundred thousand, many of them children.

Similarly, tribal conflicts have occurred elsewhere in Africa: in Uganda, Zaire, Zimbabwe, Mozambique, Angola, Cameroon, Togo, Ghana, Niger, Sudan, Rwanda,



Traditionally armed ANC supporters march through Soweto to attend commemoration ceremony for signing of Freedom Charter, considered cornerstone in struggle against white domination. Photo: AP/Wide World

the Central African Republic, Guinea (Conakry) and Equatorial Guinea. The list goes on. One may well ask, "What will make South Africa different after the elections? After the Xhosa have taken over?"

The answer, in a word: nothing. The Zulu nation, led by King

peculiar to Africa. It is accepted in Africa and abroad that most black people on the continent agree to the premise: "If your enemy is my enemy, then we are friends." But that only holds as long as the mutual enemy is active.

After South African elections in April, however, there will be no effective white government or white-dominated National Party in power or dictating policy, racial or otherwise. There will be only tribal factions and vested political interests, largely dominated by a Xhosa-led ANC. As we have seen elsewhere on this turbulent continent, the tribe comes before party, friendship, and often even ahead of family.

Goodwill Zwelethini and the head of the Inkatha Freedom Party, Dr. Mangosuthu Buthelezi, lead a proudly individualistic community that has always regarded the Xhosas and their associates with unbridled and undisguised contempt. A century ago, the only good Xhosa, according to Zulu tradition, was a dead one.

There is, of course, one other option for Zululand: unilateral direct independence, or secession from a united South Africa. King Zwelethini and Dr. Buthelezi may well represent the only black leadership who could count on the support of Zulus and Afrikaners. Such a breakout is a likely event within a year of the elections.

Meanwhile, everyone in the coun-

try is aware that de Klerk has worked a deal with Mandela to "reshape" South Africa. The old order will be replaced. In a succession of meetings — some of them secret — the two have planned a future order in the country that will guarantee jobs and positions for cronies and party members, and generally create a political establishment that, in a broad sense, is attractive enough to entrenched whites to garner their support. After all, it is the whites who voted on the issue — but both de Klerk and Mandela effectively ignored the main player, the Zulu nation.

The Zulus, guarding their own interests, want none of it. The new dispensation intends to abolish tribal traditions, homelands, figureheads and political leaders. It is not beyond the realm of possibility that it could put a Xhosa in charge of Zululand's ultimate destiny. This is why the Zulu leaders are skeptical, and they say so.

In 20 years, when some academic analyzes the history of these developments, he will reach an astonishing conclusion: that in planning for the future of South Africa, it was dangerous to ignore any major participant. It is even more absurd when one considers that Zulus are South Africa's largest tribe. Like the whites, Buthelezi fears a Xhosa-dominated South African government. Like many whites he also resists not so much the changes that abolished apartheid, but he is totally opposed to the socialist political mores and principals advanced by the ANC — a system likely to ignore private enterprise, emasculate big business (and the mines) and carve up centuries-old territorial boundaries and tribal traditions. They tried that in Nigeria in the early '70s, and we saw what happened.

It is interesting that much original ANC policy emanated from a group of hardline Marxists who had embraced ANC tenets to achieve their aims of creating a socialist South Africa. Some of these people, like Joe Slovo (who is likely to hold a cabinet post in the new government), were born in Eastern Europe. Before the changes in the Soviet Union, Slovo would spend part of each year in Moscow. He was "their man" in southern Africa.

And then there is the "right wing" bogey, an issue that remains current even though the radical Pan Africanist

Congress (PAC) and ANC associates have been the ones responsible for mass murders in churches and bars, and the ambushing of civilian buses on the country's highways.

Like many Western countries, South Africa has its lunatic fringe — groups of anti-semitic, neo-Nazi racists prancing about in khaki uniforms and saluting Hitlerite images. We have the same sort of thing with the British National Front and America's Ku Klux Klan. The only difference is that in South Africa, the Afrikaner Weerstandsbeweging (AWB) and related groups are ridiculously visible. The leader of the AWB is an alcoholic equestrian who keeps falling off his horse. As far as media copy goes, he's an easy and ridiculous cheap "touch." The trouble is, international TV and newspaper reporters tend to color many whites of South African extraction with the same brush: a bunch of semiliterate, pot-bellied, racist yahoos.

There is a great danger with this kind of caricature. It tends to lend the impression that those white South Africans who are demanding their "place in the sun" in the "New South Africa" are a cluster of ineffectual half-wits with little or no direction among them, who would be unable to look after their own interests if conditions in the country really deteriorated. No cognizance is taken of the fact that hundreds of families have been murdered in a bid to drive them off their land and that even more police have been killed.

Or that these "misfits," during the 21-year guerrilla war in South West Africa and Angola, kept the might of surrogate Cuban and Soviet forces at bay. Year after year they stymied just about every communist-bloc strategy for total military control of these embattled countries.

This was done in the face of billions of dollars' worth of investment in combloc weapons by Angola, as well as tens of thousands of Cuban troops, Soviet and East German advisers, coupled with a U.N.-imposed arms-trade and oil embargo against South Africa. The odds had not been stacked more heavily against any other country in any war this century, yet they prevailed.

Clearly, for white South Africa to take up arms to defend its real or imagined "rights" would be the final

catastrophe of the 20th century. A scenario of black forces pitted against white would loose a fire storm that could take a century to contain. The result would be South Africa — the powerhouse of Africa and one of the major economic factors of the southern hemisphere — being swept irrevocably into a vortex of carnage. Only a wasteland would result.

While black South Africans have a clear advantage in numbers, so, in turn, do whites have the preponderance of arms and expertise. The result, clearly, is another no-win situation for everyone. If anyone imagines that the United Nations might step in and bring a semblance of sanity to a crazy situation, then I suggest they think again: The United Nations can't even handle Somalia, a mere side-show by comparison.

Strangely, M a n d e l a touched on this issue on the afternoon of 30 January 1994, while addressing a crowd of supporters at the black township of Khuma. He referred to the "30-year guerrilla war" waged by the ANC in its bid for freedom, saying (the ANC) "knows how to fight."

Mandela and other black leaders have made this allusion repeatedly. There have been many claims about the military "ability" of the ANC. Yet no one in South Africa or abroad has had the courage to question this or related statements.

One might well ask: what military ability? In which wars have the ANC — or the PAC — been involved? What battles?

While in exile, the ANC did prove brilliant proponents of laying car bombs in front of supermarkets and limpet mines in post offices crowded with innocent women and children. They and the PAC have also been

remarkably successful at bombing bars full of innocent civilians, assassinating their political adversaries and executing dissidents, a crime of which the IFP is also guilty.

But when it comes to a full-blown conflict one needs to examine the record more carefully. War would be a disaster for everyone in the country. Many ANC cadres and PAC hot-heads advocate a military conflict as the final, intractable showdown. The loudest proponents of such actions, of course, are usually those with the least exposure to military matters.

The analogy definitely does not apply to the white community. Almost to a man, this society has seen military activity of some sort or an-

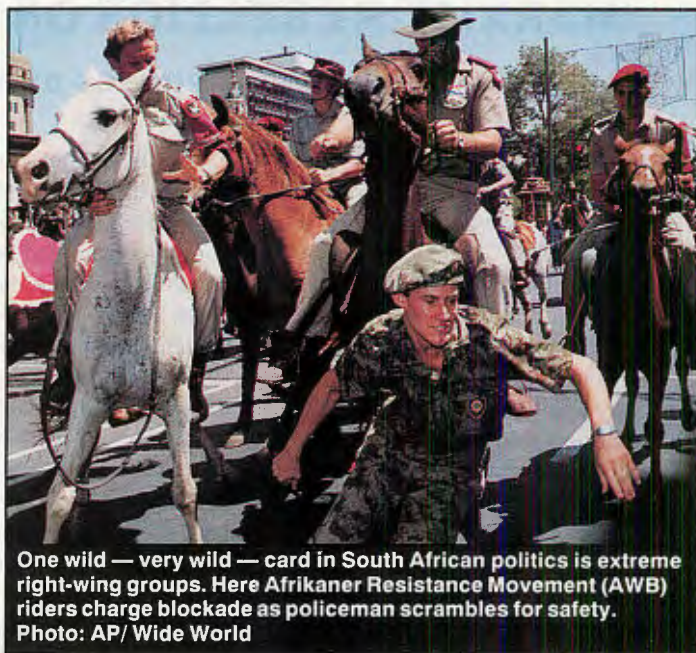

One wild — very wild — card in South African politics is extreme right-wing groups. Here Afrikaner Resistance Movement (AWB) riders charge blockade as policeman scrambles for safety. Photo: AP/Wide World

other. Many South Africans, English and Afrikaners, would react as a cohesive, disciplined and well-trained force if they believed there was simply no other recourse and that there was nothing to lose, since they were going to lose everything anyway. Irrational black demands would hasten that process.

The first shot of such a conflict would be dangerously easy. In contrast, once started, to end it all would be almost impossible.

The images of Yugoslavia loom larger.

*Al Venter is SOF's contributing editor for Africa, and author and producer of numerous books and documentary videos on African issues. ✕*



# MAYHEM IN MEXICO

## MARXIST REBELLION ON AMERICA'S DOORSTEP

TEXT & PHOTOS BY ROBERT WALCHLI

**W**edged in the back of a Mexican federal police helicopter while flying over a free-fire zone in the southern state of Chiapas, I knew we were in trouble when both pilots of our Vietnam-era Huey began pointing in different directions and yelling at each other in unintelligible Spanish. Alternately tapping the fuel gauge and studying the photocopied Rand-McNally road map, it was obvious they had absolutely no idea where we were.

Earlier the same week, with celebrations welcoming the New Year barely having subsided, a ragtag band of armed peasants calling themselves the "Zapatista National Liberation Army" (EZLN) after Emiliano Zapata, legendary hero of Mexico's 1910 revolution, surprised the world by occupying the mountain tourist center of San Cristóbal de las Casas. Armed with a "declaration of war," Marxist rhetoric and a motley collection of weapons, the Zapatistas seemed to have stepped from a textbook on Latin American insurgency.

Led by a hooded figure known only as "Commandante Marcos," the rebels met little resistance as they marched into San Cristóbal only an hour and a half into the new year. The duty officer at the nearby Rancho Nuevo military base received word of gunfire and explosions, but blaming it on leftover New Year's celebrants, merely logged the call.

By 0230 hours the rebels had attacked the San Cristóbal police station, and lead elements marched into the city square and seized the Palacio Municipal. Other units blasted trees down across the Pan-American highway, severing the region's outside ties.

As bleary-eyed tourists greeted the dawn that Saturday, hundreds of armed rebels were ransacking government offices and a few shops fronting the town square: in particular, a pharmacy (medical supplies) and appliance store (TVs?). Another

detail broke through the heavy steel doors of a warehouse, scooping up 500 pounds of dynamite.

Armed with aging Thompsons, .30 M1 Carbines and leftovers from the insurgencies in Guatemala and El Salvador, the rebels temporarily set up a command post in the town hall. But by nightfall the approximately 500 rebel troops occupying the town began pulling out, torching city hall and commandeering numerous vehicles. The main body headed for the military barracks and federal prison

Armored troops in Panhard ERC 90 F1 Lynx recon vehicle move into town in a show of force. Armored columns stretching the length of small mountain towns are a tanker's nightmare — fortunately EZLN showed no anti-armor capability.



at Rancho Nuevo, six miles away. They successfully attacked the prison — where guards decided they had urgent business elsewhere — and released 179 prisoners, some of whom joined the rebellion.

A pitched battle the following day cost the rebels at least 10 dead when, flush with success, they attacked the heavily defended army barracks. Five government soldiers and one Red Cross worker were also reported killed in the attack. Another 14 rebels died when their VW van ran into an armored relief column.

While all this was happening, separate elements of the EZLN, wearing the traditional red bandanas and mismatched military uniforms synonymous with Central American revolutionaries, stormed the towns of Ocosingo, Altamirano and Las Margaritas. Three policemen in Las Margaritas were shot defending the town against a rebel contingent of some 200.

Another unit kidnapped the former governor of Chiapas, Absalon Dominguez, from his ranch near Comitán de Dominguez. Apparently acting as point element in a pre-planned retrograde, the same unit then secured the village of Guadalupe Tepeyac, only 800 meters from the Guatemalan border.

After being repulsed at the Rancho Nuevo barracks, the main body of rebels headed by road to reinforce Ocosingo. Securing the nearby towns of Huixtán and Oxchuc, the Zapatistas soon controlled the entire 40-mile-long Ocosingo Valley.



Armed with license-built G3 rifle, Mexican infantryman guards building beneath rebel slogan. Some such graffiti spelled out G's intentions: *Gone to Rancho Nuevo, Tuxtla and Mexico City.*

Vowing a fight to the finish, the main rebel force, now approximately 800 strong, held Ocosingo through Sunday, skirmishing with Mexican government paratroops and mechanized infantry sent from Palanque. By early Monday morning, however, overwhelming government forces began arriving. Armored convoys clogged the roads as helicopter gunships roared overhead. Soon the estimated 3,000 government troops began overrunning guerrilla positions, with 25 rebels and 30 soldiers reported KIA in Sunday's fighting. By Monday the rebels were in full-scale retreat.

Gunships and aircraft strafed the retreating rebels, but the weather soon

turned overcast and grounded all aircraft, giving the Zapatistas two days to make good their escape. The main body of G's retreated through the rain forest toward the previously secured village of Guadalupe Tepeyac, but numerous smaller bands were absorbed by the towns and villages surrounding San Cristóbal and Ocosingo, as rebels simply returned to their homes and farms in the highland villages to lay low. Reports of armed men in the countryside shooting at aircraft prompted the army to saturate the area with ground troops.

The army blocked all roads. Checkpoints were everywhere. House-to-house searches were conducted for weapons. Over the next several days skirmishes were reported in the smaller communities of San Felipe, Chanal, Teopisca,

Cancun and San Andreas. Aerial bombing near several villages drove hundreds of refugees into shelters in San Cristóbal.

Stranded in the middle were hundreds of tourists visiting the area's quaint Mayan villages and nearby ruins. By attacking San Cristóbal, which hosts more than 1.2 million visitors each year, the Zapatistas gained immediate and extensive international media attention.

But that doesn't mean it was easy to get to San Cristóbal once the shooting started. As soon as I heard what was going down, I caught the next flight to Mexico, where I linked up with Frederico Martin of the Mexi-

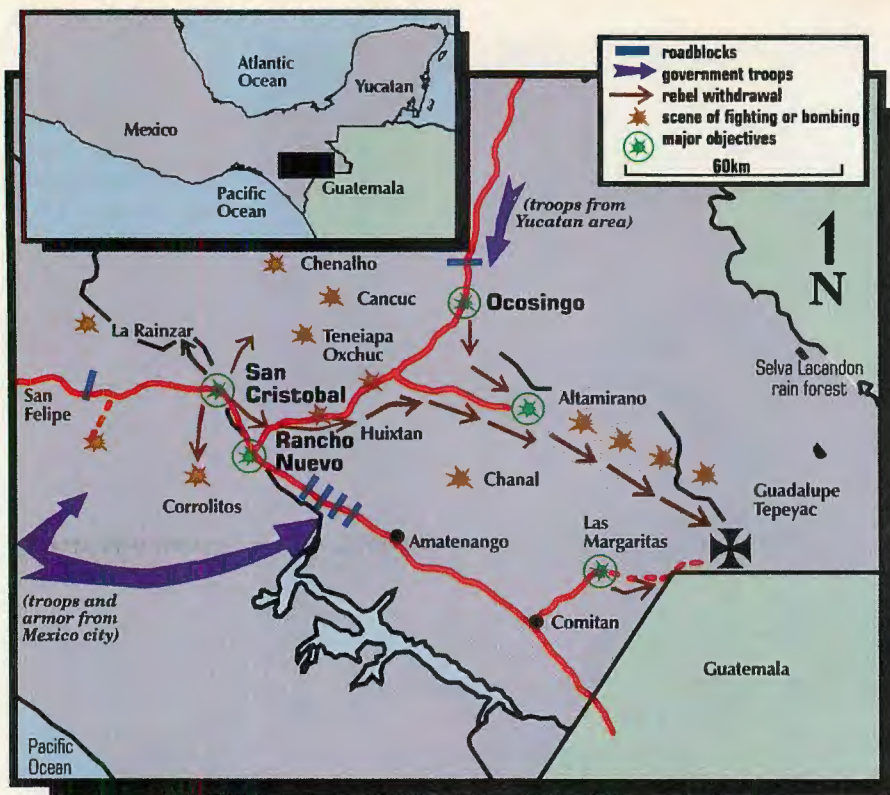

Zapatista rebels managed to briefly control 40-mile-long Ocosingo valley in southern Mexican state of Chiapas, before Mexican forces drove them into rain forest along mountainous border with Guatemala. Map: Kristine Anderson

can newspaper *La Reforma*, and we painted the requisite "TV-Prensa" on his car. Everybody in the war zone, including the guerrillas, paint their cars with "prensa" signs. So everyone still shoots at you, but it looks macho.

"*Journalista Americano muy importante*," I told the 16-year-old MP at the first roadblock, waving my impressive collection of press cards in his face. He responded by shoving his MP5 in mine.

"*Sube su manos!*" (Get your

hands up.)

These guys are a little paranoid, I thought as I carefully placed my hands on my head. We managed to convince the kid's sergeant that we really weren't Zapatista reinforcements, and they let us pass.

Several hours and checkpoints later, we were roadblock experts: There were two types. At one, they'd wave us through; at the other, they'd tear the car apart looking for anything illegal to pin on us, or steal. The trick was telling which kind was which. We figured out real quick that when the teenage guards racked a round into their FNs or H&Ks it meant "Stop!" It got to where we didn't bother repacking our stuff and just threw it all in the backseat. They never did find the dive knife I had strapped to my left calf.

By the time we arrived in San Cristóbal the Zapatistas had pulled back into the hills and the army was in control of the central city area. Signs reading "*Viva la EZLN*," were painted everywhere. On one building, the Zapatistas had outlined their intentions, "*Gone to Rancho Nuevo, Tuxtla and Mexico City.*"

The town square was cordoned off

Soldier with H&K rifle mounting 40mm grenade launcher stands guard in Ocosingo, scene of heavy fighting.

and ringed with armor of various types. Soldiers from the 83rd Infantry (mech) were setting up a perimeter, mounting 40mm automatic grenade launchers and .50-caliber machine guns in windows overlooking avenues of approach to the fire-ravaged Palacio Municipal, which the army was now using as a headquarters. The Zapatistas would have been crazy to try retaking the town.

### No Subversive Press Allowed

Later, we watched as several airplanes and helicopter gunships blew the hell out of something or somebody on a mountainside about three



Soldiers man defensive position near Rancho Nuevo. NCO in foreground has H&K MP5; his troops have G3 rifles, license-built in Mexico.

miles outside of Tenejapa. Trying to get closer, we pointed our car in the direction of the action and made good progress until we rounded a bend in the road and nearly hit an armored recon vehicle engaging unseen targets on a forested ridge a mile downrange.

From the car it looked like they were killing a lot of trees and not much else, but we jumped out with our cameras, and immediately found ourselves staring down the barrel of a .50-cal. machine gun.

Our impressive press credentials failed to impress, and since it was obvious the track commander didn't want us around to photograph any accidental shelling of some poor campesino's shack, we decided to try our luck elsewhere. Five clicks outside of San Cristóbal we hit another roadblock. "*El camino esta cerrado*," said a burly airborne officer, informing us that due to the media's "subversive campaign to discredit and embarrass the Mexican army," and

citing an accidental gunshot attack on a press vehicle the day before, we were persona non grata and expressly excluded from the war zone for our "protection."

So much for freedom of the press. This, we discovered, was the beginning of a series of incidents over the next few days in which the press and human rights observers, including the International Committee of the Red Cross, would be sanctioned and refused access to contested areas — often at gunpoint and under threat of arrest. The intimidation got so bad that photographers for major news organizations gave up in disgust and walked out on assignments, while American newspapers pulled their people out in frustration. I can't blame them, but they played right into the government's hands, allowing the authorities to successfully repress potentially embarrassing news — such as when a number of dead rebels (between eight and 10) were found by reporters Monday afternoon, hands tied behind their backs with gunshot wounds to the head.

The Monsignor Ruiz, bishop of San Cristóbal, publicly accused the army of executing prisoners, and reports of other army excesses were reported by the local AP press office. Ruiz, an ardent supporter of Indian rights, pointed out that a young Venezuelan scientist, who was working on a project for the Smithsonian Institution, had been arrested and interrogated for eight hours because he "looked"

Young men move about their business under the cover of white flags: This was not a good time to wear a red do-rag.



like Zapatista Commandante Marcos. Of course, nobody had ever seen Marcos without his hood, and he could easily have been sitting in a cafe having the laugh of his life as 15,000 troops scoured the countryside looking for him.

From what I gathered on the ground, the uprising is a classic peasant rebellion by a people fed up with centuries of oppression and discrimination, who see no future as their jungle habitat is raped by clear-cut logging and slash-and-burn agriculture. Discontent in the highlands of Chiapas state, home to hundreds of thousands of Indian descendants of the Maya, has been building for years, but reports of guerrillas were dismissed as narco-traffickers and bandits.

Meanwhile from a flourishing base of discontent deep within the impregnable Selva Lacandon rain forest, the Zapatista army was born. There, bordered by the towering volcanoes of Guatemala to the south, the Pan-American Highway to the west and the Rio Usumacinta to the east, a cadre of mostly young guerrillas was being trained, and a revolution formed under the noses of Mexican authorities.



Patrol, armed with G3 rifles, forms up. As army made initial sweeps, G's retreated to smaller villages, mountains and the depths of the rain forest.

As early as May 1991, reports circulated at high levels of government detailing unusual activity and sightings of armed bands in the Selva Lacandon. It was two years before any official inquiry was undertaken. Federal police began their investigation in Ocosingo, jailing 10 campesinos and two Guatemalans for the murder of a soldier. Satisfied they had foiled the revolution, they returned to Mexico City: The Zapatistas kept on training. Last November, Mexico's minister of the interior answered rumors with a media statement that, "In Chiapas, there are no guerrillas."

The 1910 goal of Emiliano Zapata, the popular revolutionary hero whose name they have borrowed, was to restore lands appropriated from the landowners to the dispossessed indigenous communities. He did not plan to take the capital nor introduce socialism. Leading the stated demands of current "Zapatistas" are land reform, better living conditions and democracy for impoverished indigenous Indians, followed by schools, medical clinics and opposition to NAFTA and growing foreign influence — in particular an end to U.S. training of Mexican military troops.

Along with the elusive Commandante Marcos, the Zapatista leadership appears to be professional, urban guerrillas with university educations. They are similar in profile to those in Central America or Peru. Some of them are probably veterans of these guerrilla movements who command arsenals no longer needed in their failed revolutions at home.

Although the indigenous people re-

cruited have suffered enough abuse to make them listen to revolutionary leaders, this is not a spontaneous, reactive uprising, but a carefully orchestrated campaign with an agenda beyond local agrarian reform. Commandante Marcos, who claims he takes orders from the Indian "High Command," admits to being from Mexico City, having come to Chiapas in 1988 after becoming disillusioned with Mexico's ruling PRI political party. (Which was accused of fixing the Presidential elections to maintain their 64 year grip on the country.)

The Indians, tired of watching their children die of preventable disease, of outside corporations raping their rainforest for lumber and of not having

stretched for blocks, all waiting for food. With stores closed since the fighting began, this was the first time many people had left their homes since New Year's Day.

The brother of a local restaurateur summed up the action: "It was bad, the Zapatistas ransacked several homes near the town square. I hope the army kills all the damn Zapatista sons of bitches," he told me, adding there were still rebel bodies lying in the marketplace.

His attitude seemed prevalent among the townspeople. A root cause of the uprising is the traditional racism directed against indigenous Indians. Several people commented that they felt the rebels were just good-

food and supplies, so the army had been ordered into the highlands — but the army didn't count on running into the independent Chamulans.

Direct descendants of the original Maya, Chamulans hate *everybody*: They hate the government, the Zapatistas, even the tourists who come to view their colorful market days. Arriving in town just minutes ahead of the convoy, we were confronted with the most incredible spectacle of the war.

Dressed in ceremonial robes and carrying brass-handled fighting sticks and machetes, the Chamulan "army" — about 40 elders and headmen — was marching in formation toward the crossroads to engage the Mexican army. Other groups were blockading the road into town with dump trucks. With my driver telling me I would be killed by the superstitious Chamulans, I took a few surreptitious photos. Apparently he was telling the truth: I later learned two German tourists taking pictures in the square had been murdered by enraged Indians.

I told you, Chamulans hate everybody.

A local explained the obvious: "We don't want the army here, and if they try driving tanks into our town, there will be bloodshed." *Yeah, I thought, yours, if you try fighting tanks with sticks and machetes.*

The army decided not to push the issue, at least not without orders from higher command, so they just set up a defensive position at the crossroads. The troops were still there days later, so I guess the Chamulans won. They're little people, but they've got some big *cojones*.

Ultimately, 17,000 troops were committed to quelling the rebellion. More than 100 pieces of armor and dozens of helicopters and planes were deployed. Though no stranger to violence due to frequent clashes with drug traffickers and dissident peasants, in Chiapas the Mexican army was out of its league going up against a mobile band who knew the terrain and enjoyed support in many of the villages.

By no means, however, did the Zapatistas enjoy overwhelming popular support: Many villages were neutral, or against the rebels. In occupied towns, feelings ran mostly



Chamulan "army" marches to engage the Mexican federal forces. It was a draw.

any political voice were ripe for revolutionary recruiters — they simply had nothing left to lose, but their lives. And in Chiapas, life is cheap.

So, though they fight to resolve concrete grievances concerning political oppression and social/economic inequity, they are guided and goaded by a cadre of liberation theology advocates who preach violence. They are being used, in other words, by those who have a larger agenda.

When I finally reached Ocosingo on Tuesday, the army was in total control. Signs of the previous day's battle, which ended while I'd been battling roadblocks, were still apparent. Heavily armed soldiers peered from the second-story balconies of burned-out buildings, and armored convoys cruised the surrounding countryside. A queue of women

for-nothings who wanted government handouts. "Let them go get a job," said the proprietor of one store — but I saw no Indians working in her establishment.

At the market, light infantry, covered by armored vehicles mounting everything from .50-cal. Brownings to 90mm cannons, were just finishing policing up bodies and loading them on a truck. Spying my cameras, several soldiers on guard duty intercepted me, their FN FALs at the ready.

"No photos! Fuerase!" — Get out of here!

I continued to chase reports of guerrillas in the hills, trying to outmaneuver the army's blockading of main roads. One day I raced an armored column toward the indigenous town of Chamula. Scuttlebutt was the rebels were coming in at night for

Continued on page 70

# Fighting FIRE Under FIRE

## Yanks Dodge Bullets And Backdrafts To Save Sarajevo

Text & Photos by Mark H. Milstein

It's doubtful John Jordan even heard the gut-wrenching whine of the Serb-fired 155mm shell that crushed the dilapidated house on the edge of Sarajevo and buried 6-year-old Elvir Adzamija and two other children under tons of concrete and wood.

However, Jordan — a seven-year U.S. Marine Corps veteran and Rhode Island volunteer firefighter — did hear the garbled, frantic calls for help radioed by New York paramedic Jim Schrang, busy digging bare-handed through the house's rubble in search of life.

The high-pitched crackle of Kalashnikov fire filled the cab of their Ford pickup as Jordan and fellow American fireman Captain Robert Triozzi both instinctively tightened fire-helmet chin straps and raced down Sarajevo's sniper-infested streets toward what they hoped would be just another routine rescue.

Routine, that is, for Bosnia's capital city — under siege for two years now — where some 10,000 civilians have lost their lives to sniper fire and shelling, where food is rationed by the gram, where electricity, water or gas might appear once a month and where firefighting under fire translates into a one-in-five chance of becoming a war casualty.

After watching videotape of firemen being hit by sniper and mortar fire during a two-alarm blaze at the city's arts academy, "I could no longer just sit back and watch these

guys fight fires without any equipment, in jeans and T-shirts," the 37-year-old Jordan told *SOF* recently from behind his cluttered desk in Sarajevo's main firehouse.

After long talks with his girlfriend Beth Hoban, Jordan decided one morning to take action. Armed with a sense of injustice and a will to help at any price, he visited Bosnia's mission to the United Nations and talked them into issuing him an I.D. card, then left his \$50,000-a-year construction job to walk into a city he described as "looking like something out of the first scene of *The Terminator*."

"No one knew who I was, and here I am going to the firehouse asking if I could help," Jordan said. "They looked at me like I was crazy." After nearly three weeks making contacts in Sarajevo, Jordan returned home to begin an exhaustive search for someone willing to give him 300 quality firefighters' suits on credit. He eventually located Globe Firefighters Suits of Pittsfield, New Hampshire, which

shipped him the uniforms at half-price — around \$77,500 — with no money down. Only one problem now stood between Jordan and helping out Sarajevo's firemen: getting the 4,000 pounds of NoMex suits into Bosnia.



Capt. Robert Triozzi in front of French VAB armored personnel carrier mounting Browning .50-caliber machine gun. This APC belongs to the French rapid reaction team, which provides covering fire/intimidation value allowing American and Bosnian firefighters to extinguish blazes without being gunned down in the street.

Enter the U.S. Air Force, which — after some skillful massaging and assistance from Rhode Island Sen. Claiborne Pell — agreed to ship Jordan's two-ton goodwill package free of charge. "There were big smiles all around when I came back to Sarajevo with all the uniforms," Jordan recalled.

Jordan's loyalty and doggedness soon earned him the respect of Sarajevo's fire department. But for

John Jordan digs through rubble looking for buried child. He heads up Global Operations Fire/Rescue Services and along with other American volunteers is making a big difference in Sarajevo.



Jordan, helping out Sarajevo's firefighters ultimately meant confronting deep inner emotions, as well as stretching his mental and physical skills to their limits while being pushed to the brink of bankruptcy.

"The first months were really tough," Jordan recalled with a heavy sigh. "We were losing trucks and men almost on a daily basis.

There was never enough fuel, and Beth and I were living on savings, a few small donations and our credit cards. Except for not having lost a fireman in some time, none of our other problems have gone away."

It would take months of persistence — along with the results of a stinging Serb tank barrage on a French marine compound — to get the United Nations to finally acknowledge Jordan's importance.

"The French had just taken up position at the old Olympic stadium site, when the Serbs dumped about 70 tank shells into their motor pool," Jordan said. "The place was a mess. Ve-



what arguably will be remembered as his greatest gift to the Sarajevo fire department — guaranteed U.N. military protection. Instead of firemen being passive targets for Serb snipers and gunners, Jordan now had the ability to call in elements of the French army's rapid reaction team, a newly formed unit designed

to extricate — with return fire if necessary — U.N. personnel pinned down by hostile forces.

Less than a week after receiving the U.N.'s security pledge, Jordan got his first chance to test the speed and resolve of a

United Nations that had finally realized what many already knew: Without Sarajevo's fire department and its determined American volunteers, the city would burn to the ground under the weight of incendiary shells and drown in its own blood.

A call to put out a smoky apartment fire near the old Olympic village seemed routine enough at first glance — in a city counting itself lucky if less than 100 shells land in its tight confines on a given day — but as Jordan recalled, events transpiring between the first burst of hostile fire and the French rapid reaction team's arrival finally proved the new U.N. security system had begun to work.

Within minutes

hicles were on fire.

"We responded, dismantled the .50s off of the burning APCs, took out the ammo, all the while under attack; it didn't matter that for all these months the U.N. didn't want to know who we were. It was a fire — we responded, that's all. We did our job."

Jordan's heroics that afternoon eventually translated into

after Jordan and a handful of firefighters geared up to enter the apartment building, Serb gunners in the hills overlooking Sarajevo trained an antiaircraft gun their way, forcing the firemen to take cover behind a low concrete wall. Five tense, critical minutes passed, with Jordan and

Firefighter/mechanic attempts to repair antiquated fire truck recently damaged by mortar fire. Note various bullet holes and pockmarks from negotiating Sarajevo's mean streets.



his men unable to stretch their hoses from the pumper truck to the fire — then starting to burn its way into a second apartment. Using his radio handle, "Voodoo One," Jordan was able to make contact with the reaction force and get a team sent to his location.

"Shooting at the local firemen ... we consider it not an act of war, but a criminal action," Jordan said. "We're just not going to have it. If you want to shoot them, you're going to have to shoot through us [American firefighters, paramedics and UNPROFOR troops], and most Serbs aren't willing to do that. Especially if the French show up with their own big guns. Whether the French will shoot back hasn't become an issue yet. Because, so far, every time they've responded, the [hostile] fire has gone off like a switch."

Jordan continued: "We make two calls when we come under fire. One is to the UNMOs [United Nations Military Observers], the other is to the reaction team. The reaction force does the physical act of coming out. The UNMOs, since they are very familiar with where the guns are, know who's doing the shooting.

"These UNMOs are pretty sharp. They generally know who the commander is. And since they have radio contact with each commander, they'll



American Jim Schrang and Bosnian firefighter dive for cover as they come under Serb machine-gun fire while answering a "routine" call.

literally call up and say, 'We've got some of our people under fire, we've determined there's no military target there and your boys are just shooting firemen. So, knock it off.' That has worked."

Since the first days of the war, a dozen Sarajevo firefighters have lost



their lives and nearly 50 men have been wounded trying to put out more than 1,900 major structural fires. "Half of the guys here who are wounded will never return to duty again," Jordan observed. "We're talking traumatic amputations ... I think I did a count a while back, and 60% of our injuries are from antiaircraft fire. It seems that the 20-millimeter, triple-barrelled piece of shit mounted on a flatbed truck is the weapon of choice against firemen."

The 20mm M55 towed antiaircraft gun was manufactured for many years in Yugoslavia under license from Hispano-Suiza and proved to be an effective weapon against slow, low-flying aircraft. Against firefighters and their non-armored equipment, it has proven devastating.

"The number of trucks we can field varies on a daily basis," Jordan said. "Before the war, they had 58 vehicles. We had 22 pumpers. Now, every day we've got to scrounge for parts. Every day something breaks down or gets shot up. Right now we've got 11 decent fire engines of varying sizes. We've got two more trucks that have been donated from New Jersey and Wisconsin. But any one of these trucks could go tomorrow. We need windshields, filters, hoses, belts and the wherewithal to buy them. We are under siege here."

Jordan's financial situation was supposed to have eased when the United Nations High Commissioner for Refugees [UNHCR] took his effort under its aegis, but yards of red tape and bureaucratic incompetence have thus far prevented his operation from getting out of debt.

"I was up in Zagreb [Croatia, site of UNPROFOR headquarters] talking with this guy about getting a vehicle down here," Jordan said. "And some woman, who I think I said hello to once, comes by and says, 'Oh, you're under us [the UNHCR's Department of Social Services].' I'm thinking, well, it's nice to be under someone who's being nice. But it hasn't turned out well."

The U.S. volunteer firefighters were earmarked for a \$200,000 UNHCR budget, covering everything from salaries to fuel. However, an omission on the complex U.N. funding application nearly left Jordan and his girlfriend homeless. "Beth and I had flown to Zagreb and filled out the necessary paperwork," Jordan said. "We explained to them that Beth had her house riding on this, that we were overdrawn on our credit cards, our donations had dried up and we desperately needed the money to pay back our debts. They said, 'Sure, alright, everything on the application is correct,' and we'd shortly get our money. Well, weeks went by, and nothing. I finally went back up to Zagreb to find out what was wrong, and this girl says to me, 'Oh, you made a mistake on the application and Geneva returned it a few weeks ago.'

"I thought I would kill her," Jordan continued. "This was the same girl who asked me to take a food package to her family in Sarajevo. I said, 'What? You talked to me a dozen times in the past six weeks and didn't tell me the paperwork

had been returned, knowing full-well I was bankrupt, my girlfriend was going to lose her house and all you cared about was getting some stinking food package to your family?' — That's what I'm up against."

That and the brutal reality of the firefighting business in Sarajevo. I was there when Jordan and Triozzi arrived at the collapsed house cited at the beginning of this article. It was pure chaos.

Schrag, a half-dozen firemen and 20 neighborhood men were clawing through a tangled web of steel rods and broken cement in a frantic effort to find the three children known buried there. As the designated incident commander, Triozzi immediately jumped into the breach and began coordinating rescue efforts.

Light machine-gun fire echoed off the nearby hills. Jordan, meanwhile, was on the U.N. radio net trying to draw elements of the rapid reaction team to the scene and requested a crane from the French engineer battalion. Dozens of onlookers, reporters, Russian army engineers and U.N. personnel crowded around the rubble.

Finally, after nearly an hour of digging, Triozzi came upon Elvir Adzamija's shattered body. It was too late for Schrag to begin resuscitation efforts, but with two more children trapped beneath the debris, there was little time for tears.

Hours passed. As darkness came the rescuers began openly wondering how much time it would take to find the remaining children. The large white U.N. crane had finally arrived. With the help of a translator, Triozzi directed the French soldiers on what exactly must be done to lift the larg-

*Continued on page 64*

Sniper strikes are a constant threat for Sarajevo's firefighters as evinced by the shattered windshield of this pumper truck.

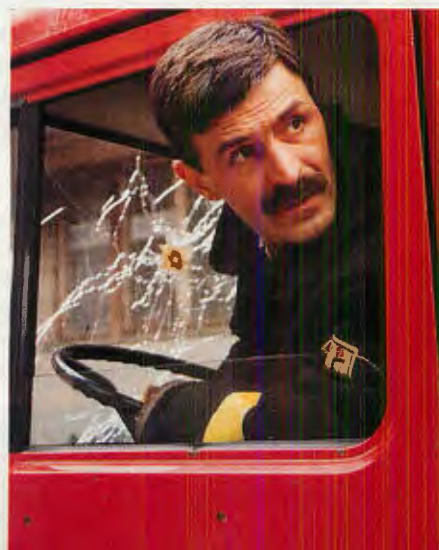



# BELLY

## **HALF-PINT WHEELGUNS FOR BACKUP AND PERSONAL DEFENSE**

**TEXT & PHOTOS  
BY PETER G. KOKALIS**

**Revolvers are a long sight** from moribund. They still have their aficionados and lethal applications — but no one can deny that they will rarely be found strapped onto the equipment belt of a police officer. Semiautomatic pistols, first in 9mm Parabellum and more recently in .40 S&W (Glock now sells two .40 S&W pistols for every 9mm), have pushed them off the belt and into ankle holsters and other concealment locations on the body.

Small-framed revolvers, usually chambered for the .38 Special cartridge, and with barrel lengths of mostly 2 inches (up to a maximum of 3 inches) are commonly known as “snub noses” or “belly guns.” They remain popular in law enforcement circles and with armed professionals, primarily as concealed “backups” to more serious ordnance. However, never forget that a belly gun you’ve slipped into your pocket is far more potent than the M1911A1 you left on top of the nightstand.

Let’s examine the top choices in this genre and the holsters, modifications, grips and ammunition that most professional gun handlers add to these half-pint wheelguns to enhance their hit probability and lethality. There are a number of excellent alternatives.

The epitome of the belly-gun type is the Smith & Wesson J-frame series. Designed as a five-shot .38 Special with the greatest emphasis on reduced weight and size, the first of this series, the so-called Chief’s Special Model 36, was introduced in 1950. While it still remains popular in blued-steel, stainless-steel and alloy-frame models, in my opinion, the concealed-hammer Centennial and Bodyguard models are the very best of the J-frames.

In 1952, during Smith & Wesson’s centennial year, they announced two new J-frame revolvers, each with a fully concealed hammer — thus combining the salient feature of the old Safety Model, introduced in 1887, with the two-year-old J-frame. Called the “Centennial” Model, the aluminum alloy-frame “Airweight” version (later called the Model 42) was the first to be produced. After the first 37 specimens were fabricated with aluminum-alloy cylinders (with a total weight of only 11.25 ounces), subsequent Centennial Airweights were equipped with steel cylinders and barrels for safety reasons, which increased the weight to 13 ounces. The all-steel version, known as the Model 40, followed shortly thereafter and weighed about 24 ounces. The Centennial revolvers were available with either a blued or nicked finish and were equipped with 2-inch barrels.

These revolvers were also fitted with a grip-safety on the frame’s backstrap. Many users contravened this dubious feature by pinning the safety lever in the depressed position.

# GUN INS & OUTS

Belly guns, in this instance the S&W Model 640 stainless steel Centennial, remain popular in law enforcement circles and with armed professionals, primarily as concealed "backups" to more serious ordnance.



Smith & Wesson's best belly guns, from top to bottom: M649 stainless steel Bodyguard and M38 Airweight factory-nickel Bodyguard, both with Craig Spegel "Boot Grips;" M642 Airweight Centennial and M640 stainless steel Centennial, both with Herrett's Detective stocks.



This round-butt Colt Detective Special with hammer shroud was manufactured in 1954 and rejuvenated 40 years later with Robar's NP3 process.

Because the hammer was concealed within the frame, the Centennial revolvers could be fired double-action only — an acceptable tradeoff for loss of an exposed hammer which all too often served only to snag on clothing during the drawstroke. Designed for close-range contact, those employing snub-nosed revolvers should, in theory, rarely require the enhanced accuracy potential provided by single-action operation.

### Sans Hammer Cult

During the 24 years of the series' production, sales of the Centennial revolvers were no more than mediocre. As a consequence, they were deleted from Smith & Wesson's catalog in 1974. Immediately after production ceased, a cult developed around the "hammerless Centennials" and prices for mint specimens began to escalate in an asymptotic manner — what people can't have, they want.

In 1990, Smith & Wesson reintroduced this so-called hammerless revolver as the Model 640, which blended the features of the previous Centennials, sans the grip-safety, with stainless steel construction.

The Model 640 weighs 20 ounces, empty, with an overall length of 6.25 inches. The frame is a mill-finished drop-forging. The barrel, frame and cylinder surfaces carry a moderately high-gloss polish. As with all J-frame revolvers, the cylinder holds five rounds and rotation is to the left (as it is with all S&W revolvers). The short ejector rod, which is not covered with a shroud, does not permit complete ejection of the empty cases. The cylinder latch is that of the entire S&W series and must be pushed forward to swing out the cylinder. The 2-inch barrel has five grooves with a right-hand twist of

one turn in 18.75 inches.

The sight system is simple and appropriate for the projected use of a snub-nosed revolver. A large square notch cut into the top strap complements a long, serrated ramp-type front sight blade. Both are fixed and neither have been

covered with any type of white or red dots or squares — an apparently never-ending and meaningless fetish. The front sight blade on the Model 640 is one-tenth-inch wide. The Model 640 is equipped with a smooth and narrow trigger. This is the preferred type for double-action shooting because it maximizes the trigger finger's sensory perception during the firing stroke. Wide target-type and even narrow-grooved triggers should be avoided on combat revolvers.

This model was shortly followed by the Model 642, a version with a lightweight, clear-anodized frame and a stainless-steel barrel and cylinder. Within two years this model was dropped. S&W claims that the steel and aluminum alloy finishes did not match closely enough to meet their standards.

There followed an almost confusing array of variants: the Model 940 chambered for the 9mm Parabellum cartridge, the Model 632 for the .32 H&R Magnum round and 3-inch types in both .38 Special and 9mm — with some available in blued, stainless steel or with factory satin nickel finish and aluminum alloy frames. My favorite remains the Model 640 with a 2-inch barrel.

In 1955, three years after introduction of the Centennial Airweight, the Model 38 Bodyguard Airweight was placed in S&W's catalog. It was developed for law enforcement personnel who perceived a

requirement for a concealable revolver with a protected hammer that would not snag on clothing, but could still be cocked for single-action firing. In no small measure this was also undoubtedly a response to the hammer shroud Colt introduced in 1950 for their Detective Special model.

In 1959 the Bodyguard was made available with a steel frame and catalogued as the Model 49. Both the Model 38 and 49 are still available with either blued or factory nickel finishes. A stainless steel version, called the Model 649, is also available. I frequently carry a nickeled Model 38 or a stainless steel Model 649. Although I have never had occasion to fire these revolvers single-action, the thought that they are capable of being fired in this more deliberate manner is a mildly comforting placebo.

### Maiden Belly Special

Introduced in 1927, Colt's Detective Special is the first of the modern belly guns. Through most of its production history, the Detective Special could be instantly distinguished by its completely exposed ejector rod. Its one advantage over the S&W J-frame series was a six-shot cylinder — an increase of 20% with very little increase in size or weight.

When chambered for the .38 Special cartridge, the six-groove barrel has a left-hand twist of one turn in 16 inches. Cylinder rotation is to the right (the direction opposite that of S&W revolvers — important to remember when reloading under stress with the Bianchi Speed Strip). The Colt cylinder latch must be pulled back to swing out the cylinder.

Over the years the Detective Special was offered in full range of .32 and



Charter Arms .44 Special Bulldog with bobbed hammer, barrel cut back to 1.75 inches and Tyler T-Grip installed.

.38 rimmed cartridges. There were both square and round-butt versions. The sights were almost always a halfmoon blade with a square notch in the frame just forward of the hammer as a rear sight. A serrated ramp was added to the front sight blade in 1948.

The lightweight version was the Cobra, which was introduced in 1950. The Aircrewman Model is rarer than a Walker Dragoon. It had an alloy cylinder and the entire lot of 1,189 revolvers were returned by the Air Force to Colt and destroyed. The Agent Model was similar to the Cobra, but featured a shortened and squared-off butt.

In the early 1970s, a completely shrouded ejector rod was offered as an option on the Detective Special. Within a short time it became a standard feature on the entire series. In 1984 the Commando Special was added to the line. It was nothing more than a Detective Special with fully-shrouded ejector rod, rubber grips and a phosphate ("Parkerized") finish. By the end of the 1980s, the entire Detective Special series was dropped from production. However, Colt has recently announced the revival of the Detective Special. How many, if any, will be produced, is a function of Colt's shaky financial status. Be that as it may, there were close to half a million of all variants produced and they're out there if you want one.

I have a round-butt Detective Special that was manufactured in 1954. It has an incredibly smooth double-action trigger pull. I had the trigger grooves removed and a Colt hammer shroud installed. The Robar Companies Inc. (Dept. SOF, 21438 N. 7th Ave., Suite B, Phoenix, AZ 85027; phone: 602-581-2648; fax: 602-582-0059) then applied their excellent NP3 process to the entire revolver.

NP3 is a surface treatment for metals and metal alloys that provides the appearance of satin electroless nickel by combining submicron particles of PTFE (polytetrafluoroethylene, i.e., Teflon) with autocatalytically applied nickel/phosphorus. The result is a very accurate, dry-lubricated, low-friction surface that is extremely resistant to wear. The PTFE is evenly distributed and locked into the nickel phosphorus matrix, so when wear occurs, fresh particles of PTFE are exposed to keep the surface lubricated. No lubricants of any kind are re-

quired, and powder residue and carbon fouling can be easily removed with a dry cloth.

The Colt Detective Special round-butt frame and factory grip panels fit my large hand perfectly. Unfortunately, the grips issued with S&W J-frame revolvers, until recently, exactly matched the contour of the bantam-sized round-butt frame and just would not do. Here also, there are a number of excellent alternatives.

### Custom Stockyard

Keep in mind, however, a set of grips that direct the bore's axis into alignment with the arm, fill the void between the trigger guard and the frame's front strap, and drop down below the frame to adequately conform to the dimensions of the hand, will, by definition, increase the overall package. The increase in envelope can be minimized if the grips are custom-made to the specific

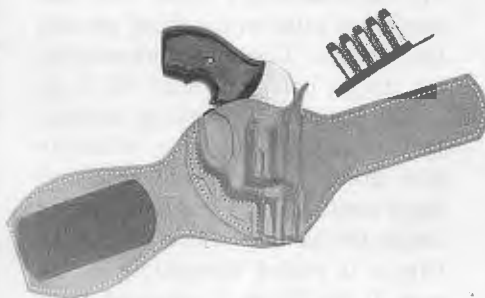

**Milt Spark's excellent Ankle Concealment Rig consists of a contoured leg strap, lined with sheepskin wool, and a holster hand-molded to the weapon it is meant to carry.**

shooter's hand and are, thus, no larger than necessary.

Herrett's Stocks Inc. (Dept. SOF, P.O. Box 741, Twin Falls, Idaho 83303-0741, phone: 1-800-635-9334) has been producing made-to-measure handgun stocks for over 40 years. I purchased my first set of stocks (for a Clark-customized Ruger bull-barrel .22 LR target pistol) from Steve Herrett more than 30 years ago.

Almost all (98%) of Herrett's stocks are made from American black walnut, noted for its strength, beauty and resiliency. A precise hand diagram is required to order stocks from Herrett's. I use their Detective stocks with skip checkering on my S&W Model 640, and without checkering on my Airweight Model 642. De-

signed to assist in the concealment of small-frame revolvers, Herrett's even requires information about the manner in which the weapon will be carried when hand-crafting a set of Detective stocks for your revolver.

However, the really hot grips for J-frames are those made by Craig Spegel (Dept. SOF, P.O. Box 108, Bay City, OR 97107; phone: 503-377-2697). His handmade cocobolo "Boot Grips" for round-butt J-, K-, L- and N-frame S&Ws are an outstanding example of equipment designed by an end user. Spegel, an IPSC competitor and Oregon combat master, specializes in custom grips that enhance control and natural aiming in as compact an envelope as possible.

The revolver's back strap is left exposed, so no extra trigger reach has been added. A slight, ambidextrous palm swell and comfortable finger grooves give a much firmer support than the usual factory grips. Unlike Herrett's Detective stocks, these grips do not extend below the frame's butt, so in most cases the little finger of the firing hand will extend below the grips. That's the tradeoff for increasing concealability. However, I have fired thousands of rounds with J-frame Smiths wrapped in Spegel's Boot Grips and have never experienced any problem with control or loss of accuracy, and they are light years ahead of the standard factory grips. They cost \$55 (plus \$3 shipping and \$5 extra for old model Centennials with a grip safety). More professional gun handlers carry J-frames with Spegel's Butt Grips than any other type. They are, at this time, so dominant in these circles as to almost constitute a fetish.

In fact, Smith & Wesson now issues synthetic Boot Grips with all of their Centennial-series revolvers. Injection-molded from Craig Spegel's original Boot Grip design, they are made by, and also available from, Michaels of Oregon Co. (Dept. SOF, P.O. Box 13010, Portland, OR 97213; phone: 503-255-6890). Steel-reinforced and molded from a tough, durable, specially formulated elastomer called Santoprene, they are lightweight and much firmer than ordinary rubber grips. This latter characteristic is important. As normally encountered, so-called neoprene rubber grip panels will absorb recoil better than any other material you can at-



Bruce Nelson's well-known No. 10 Summer Special remains the hallmark among inside-the-pants holsters.

tach to the frame of a handgun. But, if you should grip the weapon incorrectly during commencement of the drawstroke, their adhesive qualities do not permit rapid readjustment, with potentially fatal consequences. I have tried Michaels' Boot Grips and they are not subject to this criticism.

I can also recommend one other type of custom stock for J-frame revolvers. Bear Hug Grips Inc. (Dept. SOF, 17230 County Road 338, Buena Vista, CO 81211; phone: 800-232-7710) has designed their Coyote grip panels for all S&W round-butt J-frame revolvers. Made from StaminaWood — a resin-impregnated, hardwood laminate — they are available in walnut, rosewood, ebony, mesquite and cocobolo and cost \$49.95 (plus \$4 shipping). I think the mesquite grips are especially attractive; however, more importantly they redirect the bore's axis into alignment with the firing arm and fill the void between the trigger guard and the frame's front strap to reduce the tendency of these small frame revolvers to roll violently upward in recoil.

### Belt Vs. Belly

When equipped with round butts and 3-inch barrels, N-frame giants, such as the models 629 (.44 Magnum), 657 (.41 Magnum) and 624 (.44 Special) are significantly reduced in size. However, I own all of the above and they are still belt guns, not belly guns by any stretch of the imagi-

nation. Just imagine one of these brutes in an ankle holster strapped to your leg.

There is, however, one .44 Special revolver that qualifies as a legitimate belly gun. Eight years ago I obtained a Charter Arms .44 Special Bulldog. At that time it was available with a 2.5-inch bull barrel in a blued finish. Today it is manufactured by Charco Inc. (Dept. SOF, 26 Beaver St., Ansonia, CT 06401; phone 203-735-4686) and available only in a factory nickel finish with a 3-inch barrel.

Its five-shot cylinder rotates to the right (in the Colt manner) in a frame of high strength chrome-moly steel. There is no side-plate. Only the trigger guard is fabricated from an aluminum alloy. The coil-type main-spring provides maximum strength and longevity. An almost unbreakable beryllium copper firing pin can be dry-fired into infinity. When the hammer is cocked, firing either single or double-action, a small steel bar moves up between the firing pin and the hammer. Continued pressure on the trigger holds this steel bar in its raised position. The falling hammer then strikes the steel bar, which in turn strikes the firing pin, discharging a cartridge. The bar is not raised unless the hammer is cocked and the trigger is pulled completely to the rear. If the finger is removed from the trigger while the hammer is falling forward, the bar will drop downward and ignition will not take place.

I had the 2.5-inch barrel cut back (from the rear) to 1.75 inches. The front sight's ramp angle was altered and reserrated. The forcing cone angle was recut to maintain a cylinder-to-forcing cone gap of .005-inch (.003- to .008-inch is the usual range). These alterations dropped the weight from 19 ounces, empty, to only 17 ounces.

The double-action pull weight was reduced to a smooth 9 pounds with a crisp single-action pull weight of 3.25 pounds. The case-hardened hammer was bobbed with serrations cut to permit cocking for single-action firing, if required.

To all of this I added Charter Arms A17 unchecked walnut grip panels and a cast aluminum, black-anodized Tyler T-Grip (size No. 1) for \$7.50. Melvin Tyler Manufacturing (Dept. SOF, 1326 W. Britton Road, Oklahoma City, OK 73114; phone: 405-

842-8044) has been making this fine little accessory ever since 1940, and it has improved the qualification scores of many thousands of police officers during the years when service sidearms were still mostly wheelguns.

Chic Gaylord, a legendary figure in gunfighting circles — whose holsters are still highly prized and often copied — was convinced that in a holster, a 3-inch belly gun hugs the body far more effectively than a 2-inch snub nose. A coterie of pistoleros still adhere to this concept, preferring also the longer sight radius and superior balance of a 3-inch barrel on a small-frame revolver.

In my opinion, this has been best executed in the Ruger SP101 revolver chambered for the .38 Special cartridge. Made of 400 series stainless steel, the SP101 has an attractive

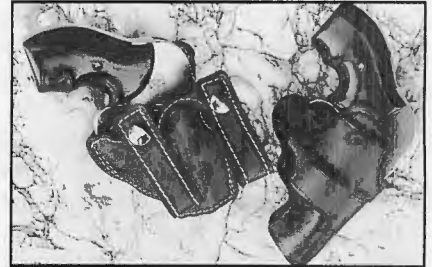

Safariland's synthetic holsters to a large extent look like leather, but wear like iron. Their inside-the-pants types include the Inside The Belt II (left) and the J Hook (right).

brushed stain finish. Its 3-inch barrel has five-groove rifling with a right-hand twist of one turn in 18.75 inches. The sights are conventional for this type of revolver: a serrated ramped front blade and an open, square-notch rear sight on the frame directly in front of the hammer. My specimen (Model KSP-183) is equipped with one-piece black Monsanto Santoprene with walnut side panels that permit the grip to be shifted during the drawstroke, if necessary.

Unbreakable coil springs are used throughout the SP101. The transfer bar trigger mechanism is coupled with a floating firing pin. When the five-shot cylinder (which rotates to left) is in the firing position, it's securely locked to the frame in two places — at the rear by the traditional cylinder pin, and at the front of the crane by a large, spring-loaded latch. Developed by Ruger, this mechanism ensures proper cylinder and barrel alignment.

It, together with the SP101's massive frame, certifies the Ruger revolver as the strongest ever built, with a tradeoff of slightly increased bulk.

I sent this revolver to Weigand Inc. (Dept. SOF, P.O. Box 239, Mountain Top, PA 18707; phone: 717-474-9804, fax: 717-474-9987) to be transformed by their "Tame the Beast" package (most often performed on .357 Magnum Ruger revolvers). The most salient feature of the custom modifications performed on the revolver was porting the top of the barrel with five nozzles. These tapered holes are calibrated using a formula that calculates propulsion thrust by means of a ratio between the available gas pressure and the size of the nozzles. The smallest nozzles are closest to the frame. While muzzle velocity is decreased only 50 to 65 fps, muzzle flip is reduced about 75%. There is a significant flash signature generated by barrel porting of the Hybra-port type. In my experience, however, the flash initiates well above the front sight and does not disturb the shooter's sight picture.

Because of the reduction in muzzle rise, Weigand lowered the front sight about .03-inch to raise the point of impact. Next, all of the action's moving components were carefully matched, altered and polished. Factory springs were not altered or replaced. Thus both the double- and single-action pull weights remain as before. The trigger was polished and rounded to provide a smoother surface for the finger during double-action firing.

The hammer was bobbed, but can be manually cocked by carefully rotating it rearward by means of the trigger until it can be grasped by the thumb of the firing hand. A double-action-only option is available.

The entire revolver was refinished by extra-fine glass-beading at low pressure to produce a frosty, no-glare surface. Some of the pin heads were polished to break up the dull finish. Price of the package is \$225, and S&W revolvers can be modified in the same manner. The package is not set in concrete and modifications can be added or deleted to suit the customer's specifications. I am very satisfied with this Weigand-modified SP101 and carry it frequently.

None of these revolvers, as issued or modified, respond to the problem of acquiring the target in subdued-light environments. No one installs better self-luminous sights on revolvers than Innovative Weaponry Inc. (IWI, Dept. SOF, 337 Eubank N.E., Albuquerque, NM 87123; phone: 1-800-334-3573). Their "BAR-DOT" night sights consist of a single green dot installed on the front sight blade and a horizontal green bar installed on the frame just under the rear



Ruger SP101 .38 Special with 3-inch barrel. Hybra-ported barrel, bobbed hammer and custom tuning by Weigand Inc.

sight notch. In the case of S&W Models 38 and 49 Bodyguard, IWI notches the hammer spur so the rear tritium sight bar is not blocked from view. These tritium-phosphormicrospheres are lightweight, insensitive to temperature variations and are always on. Decay of tritium H3 within the radioluminescent capsules creates soft beta rays that are converted to visible light when they strike the phosphor particles coating the inside of the glass microspheres. Tritium's half-life (the time required to reduce the illumination by 50%) is about 12.5 years, with a functional life exceeding 15 years. I know of no better method for delivering accurate fire at night and in low-light conditions than self-luminous sights, with the exception of cost-prohibitive passive night vision equipment — and those made by IWI are the very best, bar none.

### Bullet Abuse

The most important factor in this equation has yet to be mentioned. Nothing is more vital than the projectile your belly gun sends downrange. For all of its popularity, no cartridge has been subjected to greater abuse or more derision than the .38 Special. All of this tongue lashing would have been more justified had it been directed at the only bullet that was for so long the standard .38 Special loading with law enforcement agencies in the country.

The 158-grain .38 Special Lead Round Nose (LRN) bullet differs very little from that used in the .38 Smith & Wesson cartridge designed by Daniel Baird Wesson for the Model No. 2 Smith & Wesson single-action revolver, which was introduced in March of 1876.

Traveling at about 790 fps out of a 4-inch barrel, it does not expand, but will usually yaw 180 degrees in soft tissue and end its travel base-forward. Where the bullet yaw is at its maximum, 60 to 120 degrees, the height of the permanent cavity will

*Continued on page 66*



Gun Mate belt pack holster made by Michaels of Oregon is much smaller than most fanny-pack types and attaches directly to the belt.

# Foreign VENDETTA



Militiaman in Bosnia prepares to fire 81mm mortar at Serb hilltop positions; 60mm mortar sits unused in background.

## Bosnian Commander Crosses Legionnaires — Pays Ultimate Price

by Mark H. Milstein

Photos by Eric Micheletti

The weather report for the area around the Olympic bobsled run on Mount Trebevic was particularly dismal that Saturday morning in October — heavy lead, with intermittent artillery showers.

Lightly armed units from the much-vaunted Bosnian army's 10th Mountain Brigade were again working their way up Trebevic's steep, rocky slopes — inching their way to a break in the trees where they could set up positions to snipe and launch their 60mm M-57 mortars at a series of Serb redoubts 600 meters away.

Down the mountain, at the rear of the 10th's old-town Sarajevo headquarters, a small battery of 81mm M-31 and 120mm UBM-52 mortars was

blasting away at two well-known Serb artillery positions nestled along the road that cuts across the 5,000-foot-high mountain.

For three United Nations Military Observers (UNMOs) stationed by the Serb positions as part of their deployment in the former Yugoslavia, the incoming fire was becoming too dangerous and they radioed for an armored escort back to Sarajevo. Within 30 minutes two Renault Armored Personnel Carriers (APCs) and six legionnaires from the 2nd Foreign Legion Infantry Regiment (2 REI) arrived to accompany the UNMOs back across Bosnian-held territory.

But, as the APCs were crossing an open area, the two-vehicle convoy was set upon by heavily armed elements of the 10th, who threatened to fire at the lead vehicle with an RPG. The vehicles stopped and the militiamen pulled the observers and legionnaires from the APCs and drove off

with the two vehicles.

What occurred next is still a matter of much debate, but the end results are clear. The six legionnaires, shy two APCs, their weapons and two Browning .50-caliber machine guns, finally made it back to their barracks at UNPROFOR headquarters in Sarajevo.

### Legionnaires Robbed At Gunpoint

There, according to sources within the Foreign Legion, grumbling over the events eventually led to talk of unilateral action against the 10th and its leader, Musan Topalovic, who fights under the nom de guerre of Caco (pronounced ZAHT-so).

Topalovic — an ex-folk guitarist turned ultra-nationalist — first made headlines in the press earlier this year through his rather unorthodox methods of dealing with Bosnian draft dodgers and others he considered slackers and subhumans. As part of his efforts to bolster Sarajevo's defenses against the Serb aggressors, Topalovic ordered his troops to patrol Sarajevo's center and old town in search of those not in uniform.

When found, those unfortunate enough not to be able to produce the required papers were marched off to the front



lines of Mount Trebevic, given a shovel or pick and told to dig trenches until ordered to stop. Often those ordered to "dig for victory" became easy targets for Serb snipers hiding in the woods, many times less than 50 meters away.

Topalovic also found members of the foreign press and civilian employees of the United Nations prime targets for his campaign to provide topnotch



Bosnian militiaman armed with Yugo 7.62x39mm M59/66A1 rifle stands watch along supply road outside of Sarajevo.

# egion

Kevlar wear for his troops. Hundreds of bulletproof vests and flak jackets were robbed over the past year at gunpoint from those who made contact with elements of the 10th.

While Topalovic was suspected of being on a short leash that led directly back to the Bosnian presidency, the specter of a Foreign Legion-led lynch mob prowling the streets of Sarajevo in search of revenge may have been the event that triggered the end of his usefulness. As word of a possible revenge raid

on radio Sarajevo comparing his orders to actions against the population by the Nazi forces that occupied the city during World War II. But U.N. officers said that accepting the theft would have signaled to the gangs that U.N. troops and equipment were fair game.

## A Vendetta Is Born

"What we had at the legion barracks that afternoon was classic," said one Irish-born legionnaire who asked not to be identified. "My mates were at the breaking point because they had to surrender their weapons and vehicles to the Bosnians, and the rest of us wanted to destroy this guy [Topalovic] once and for all.

"Some of the officers were all for it," he contin-

Browning being returned the next day.

"Most of the legionnaires involved in the incident were still talking about finding this guy Caco, but our officers had their orders not to allow things to get out of hand," the legionnaire told me. "All of our escort duties were suspended that day, and we were ordered to stay put at the PTT [Post Telegraph and Telephone]."

As legionnaires' tempers flared to the boiling point, the Bosnian president — made aware of the legion's intentions to hunt down one of their top military commanders and exact some sort of revenge — decided to pull the plug on Caco and ordered his arrest.

On the following Monday evening, members of the Bosnian army general staff were called to a special meeting and a crack assault unit was assembled to carry out Topalovic's capture. Named along with Topalovic was Ramiz "Celo" Delalic, commander of the 9th Mountain Brigade and a close ally.

The 150-man special Bosnian army assault team — made up of members of the presidential guard, military police, the Bosnian army 101st Motorized Brigade and a newly formed special ops unit, each identified with a white armband — was assembled early on Tuesday morning near the city's center. The team came armed to the teeth with a wide array of weapons, including Yugo M59/66A1 (an SKS derivative) and Kalashnikov assault rifles, Yugo M53 (a replica of the German WWII MG-42) GPMGs, a 75mm recoilless rifle and a three-barrelled 20mm M-55 anti-aircraft gun mounted on the back of a

flatbed truck.

Sead, a Sarajevo policeman who manned a barricade less than 100 meters from Caco's fortress, described the assault to me. "One of the special army



Bosnian emblem worn by both Croats and Muslims early in the conflict, now largely replaced by insignia of various warlords and subfactions.

unit commanders called to Caco and Celo on the telephone and asked them to surrender," Sead recalled. "But they said they would rather die than give up, because for them there was no life after something like this.

## Bosnian Vs. Bosnian

"We could hear gunfire from across the river in old town, and from radio traffic knew our teams were killing a lot of Caco's soldiers," he said. "Many wouldn't give up. Then, all of a sudden, our units began using the 20mm gun on Caco's headquarters.

"The fire continued for a few minutes while about 15 of our soldiers started running toward the side of Caco's building," Sead went on. "Our soldiers started to launch grenades from their rifles, and Caco's men returned fire. A lot of our men were hit. When our commanders learned there were hostages in the buildings they decided not to use more heavy weapons; instead, we had to use tight rifle fire and grenades to get them."

Sead said the Serbs on



Anatomy of a bad move: Bosnian 10th Mountain Brigade troops robbed French legionnaires — at gunpoint — of two French Renault VAB armored personnel carriers, similar to the one pictured. Photo: Mark H. Milstein

began to slowly filter up through the U.N. chain of command, reports of the ambush and theft quickly found the ear of General Jean Cot, the overall U.N. commander. Within hours, Cot was airborne to Sarajevo, and while en route ordered the suspension of a wide range of U.N. activity in the city.

The French general's action set off a storm of protest, with commentators

ued. "They were out of their minds over the thing. They didn't like being here in the first place. We can't even operate like we were trained to. We are legionnaires, not peace-keepers. But some other officers from the U.N. command came down and told us to sit tight until something could be worked out." That something resulted in the vehicles, five of the six FAMAS rifles and one



# COUNTERFEIT GUNS

that are inexpensive to own and safe to display in your home. They are realistic, full size working metal models that look, feel, weigh and handle like the expensive originals. You can work the action, release the clip and dry fire these high quality models. **CANNOT BE FIRED!**

**ISRAELI UZI SUBMACHINE GUN**  
Used by Israeli troops in the historic 6-Day War, the Entebbe Raid. Adopted 30 other nations as the most successful sub-machine gun on the market today.

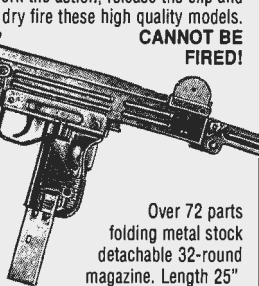

Over 72 parts folding metal stock detachable 32-round magazine. Length 25" Wt. 9 lbs. #01-705M.....\$310 PPD

**Exact Replicas in Metal.....**

**1921 THOMPSON**

as used by FBI & U.S. combat troops. Over 59 parts, including vertical foregrip, detachable wood butt-stock & 20-rd. magazine. Lgth. 35". Wt. 9.5 lbs. Disassembles like original.



#01-700.....\$299 PPD

**Full size (non-firing) models look, weigh, and handle like the originals.**

**M-16 ASSAULT RIFLE**

The ultimate defense arm as used by S.W.A.T. forces. Made famous by U.S. troops in S.E. Asia. Full size. Bolt functions like original—over 70 ABS plastic and metal parts. CANNOT BE FIRED. Lgth. 39". Wt. 5 lbs.

Declared "non-gun" by the Federal Gov't. #39-2707.....\$300 PPD

**FULLY ASSEMBLED**

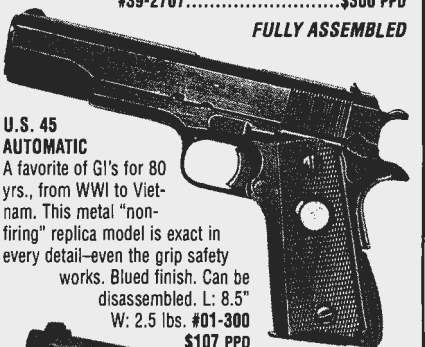

**U.S. 45 AUTOMATIC**

A favorite of GI's for 80 yrs., from WWI to Vietnam. This metal "non-firing" replica model is exact in every detail—even the grip safety

works. Blued finish. Can be disassembled. L: 8.5" W: 2.5 lbs. #01-300 \$107 PPD

**M92 AUTOMATIC**

This massive 9mm was chosen to replace the .45 auto. Made famous in Operation Desert Storm, this blued "non-firing" metal model actionworks like the original. Can be partially disassembled. L: 8.5" W: 3 lbs. #22-1254.....\$102 PPD

**COLLECTOR'S ARMOURY**

800 SLATERS LANE, DEPT. SO BOX 59, ALEXANDRIA, VA 22313

Not sold to Calif. except for theatrical use.

SEND: \_\_\_\_\_  SEND FREE CATALOG  
Credit Card Orders: 1-800-544-3456 Ext. 515

NAME \_\_\_\_\_

ADDRESS \_\_\_\_\_

CITY/STATE/ZIP \_\_\_\_\_

**MONEY BACK (LESS POSTAGE) IF NOT SATISFIED**

Mount Trebevic "must be laughing" watching all of this. Indeed, Serb artillery and sniper fire grew heavier by the minute as Bosnian went up against Bosnian. Sead claimed nearly 500 of Caco's troops gave up rather than fight as the morning progressed, eventually leaving the renegade leader alone in a basement bunker with six of his closest aides and his sickly mother.

As swarms of pro-government Bosnian special forces swept through the upper floors of the fortress in search of Caco, Celso, and their commanders, legionnaires talked bitterly among themselves about not having been given first crack at capturing Topalovic.

"We were a bit frustrated," one British-born legionnaire said. "He [Caco] was ours. We owned him. Believe me, if we had come knocking on his door there would have been no bullshit about it. The legion would have done the job right."

When the smoke cleared later that afternoon, more than 50 soldiers on both sides lay dead on the cool, wet streets of Sarajevo, and both Caco and Celso were on their way to a Bosnian military prison near U.N. headquarters.

Caco, however, never made it to his cell. In conflicting reports that became more muddled by the hour, the special police unit charged with taking both renegade leaders to prison claimed Caco was shot while attempting to escape.

Others I spoke with said Caco died from two point-blank pistol shots — one to the mouth, the other to his abdomen — fired by the commander of the interior ministry police unit charged with his capture.

Caco's mother, the source added, killed herself with an overdose of sleeping pills shortly after finding members of the special police unit responsible for his death kicking the crumpled body of her son as it lay on the blood-caked floor of his bunker.

"It was damn close," said a senior ranking military official attached to the U.S. Embassy in Zagreb, Croatia. "The information we got out of Sarajevo had a near break between the legion and the U.N. command chain over this flap. I would not have been surprised if they had gotten Topalovic first."

*Mark Milstein is a foreign correspondent for Atlantic News Service and frequent contributor to SOF. ✉*

# FIREFIGHTERS

*Continued from page 55*

est concrete slabs off the ruins' barely visible foundation.

Jordan had gotten someone to string a single 100-watt light bulb from a nearby house to the site. With the aid of three Sarajevo firemen, he crawled into a vise-like opening in the blocks of broken masonry. He could hardly see anything. Without a generator for high-powered rescue lights, Jordan relied on the light bulb, his flashlight and the uncanny ability to sniff out life that comes with being a fireman.

Triozi directed the crane to lift two more slabs of concrete from the ruins — nothing. But shortly thereafter, he and another fireman uncovered the second child, an 8-year-old boy, still alive. Schrang immediately moved to keep the child's barely functioning life signs going.

Less than an hour later, a 10-year-old girl was found. Again, it was too late for Schrang to do anything but take her crumpled body to the city's overflowing morgue. Yet for all the rescuers, saving one life that night meant their efforts were not in vain.

"This intervention was important," Jordan said. "For the first time since I arrived in November 1992, all the elements I had worked so hard to coordinate came together. The response team came, the engineers showed up — people from UNHCR, the Red Cross, the whole works. I guess I could do a little crowing tonight. Our efforts paid off, and we saved a life."

Anyone wishing to contribute to John Jordan's Fire/Rescue Services effort can contact Col. Alex McCoil at Refugee Relief International; phone: 303-449-3750; fax: 303-444-5617. *Every penny given for this cause will reach Sarajevo's firefighters.*

While some donations for Jordan's effort have begun trickling through the RRI office, McCoil notes that essential firefighting equipment is urgently needed, including:

- Small diesel generators in the 3- to 5-kilowatt range
- Space heaters that can plug into generators (to prevent freezing of pumper and tanker trucks)
- Flashlights powered by "D"-type batteries

# Professional Locksmithing Tools

## LOCKAID

Specifically designed to pick tumbler locks. Designed over thirty years ago to aid law enforcement agencies. Consists of tension wrench, three needles and Lockaid "Gun." Prices include a copy of the book "Lock Picking Simplified."

Lockaid \$69.95



## PIX MODEL 13

This deluxe yet compact kit features 11 of the most commonly used tools. Comes in a slim cowhide leather case for discreet undercover operatives. As a special bonus, a 5 piece set of warded picks is included. A 18 piece set total. Also included, a copy of "Lockpicking Simplified." Receive all this at a Low price of:

Pix 13 \$42.95



## PXP 8

- Shirt Pocket Size.
- Top Grain Cowhide Leather.
- Has 8 Picks, Tension Wrenches and Broken Key Extractor.
- All Picks with Metal Handles.
- Copy of Lockpicking Simplified.

PXP 8 \$24.95

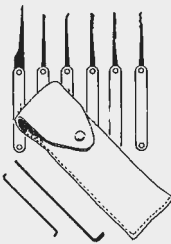

## PXP 10

- Shirt Pocket Size.
- Top Grain Cowhide Leather.
- Has 13 Picks, Tension Wrenches and Broken Key Extractor.
- All Picks with Metal Handles.
- Copy of Lockpicking Simplified.

PXP 10 \$34.95

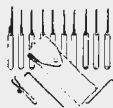

## PIX-EZ All-In-One Pick-Set

100% American Made! As convenient to carry and use as a pocket knife! Only 4 inches long, half inch square, weighs under five ounces, works fast and opens pin and water tumbler locks quickly, with very little effort. Six tempered spring steel picks, tension wrench.

\$34.95

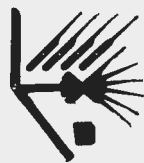

## WKS PICKS

Made of the finest blue tempered spring steel this 5 piece padlock pick-set is a must in every locksmiths' tool box. This set will pick open most every warded padlock made today.

\$9.95



## NEW MONTHLY SPECIAL

RECEIVE A COMBINATION SET INCLUDES — 5 ITEMS

1-MD-16 DELUXE SET .....	\$59.95
1-SCHALGE WAFER SET .....	\$27.95
1-SESAMEE DECODER .....	\$17.95
1-WKS PICKS .....	\$ 9.95
1-DOUBLE SIDED TUMBLER PICKS .....	\$27.95

A VALUE OF \$143.75

AT A LOW PRICE OF \$89.95

Lockpicking Simplified	\$8.50
Complete Guide to Lockpicking	\$15.00
Improvised Lock Picks	\$9.95
Tubular Locks	\$8.95
Lockout and forced entry	\$8.95
Involuntary Repression	\$10.95

Safe & Vault manipulation	\$9.95
How to Pick Pins & Wafers	\$9.95
Combination Locks	\$8.50
Keys by Impressioning	\$7.00
Key Casting Manual	\$8.95
Locks, Picks, Clicks	\$10.00

**NEW ITEMS**



## ESP-13

This handy new pick set is the most popular set among professional locksmiths today. This kit consists of 12 different tools housed in a handsome black leather case designed for a shirt pocket. Included in the price, you receive a 5 piece warded key set and a copy of "Lockpicking Simplified." 17 piece set total.

ESP-13 \$45.95



## KEY RING PICK SET



This unique design is ideal when low profile is required or to keep on your keyring for emergencies. Contains a tension wrench, three picks and the "Key Pick." Key Ring Pick Set \$27.95

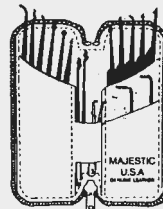

## MD16

Shirt Pocket Size, Top Grain Cowhide Leather, Zippered Case, has 16 Picks, Tension Wrenches and Broken Key Extractor.

\$59.95



## DOUBLE SIDED DISK TUMBLER PICKS

Set of 4 picks designed to be used on the most popular double-sided disc tumbler, showcase, cam and padlocks.

\$27.95

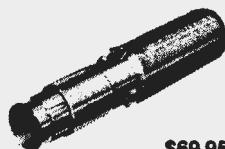

## MINI PICK TUBULAR

The most effective tubular pick on the market, unlike the larger picks with long handles or screwdriver handles. The longer the tool, the more pressure needed which causes easy breakage. The advantage of the Mini Pick is it is so short, you only use your thumb and index finger. With a little practice this tool will open a tubular lock in less than a minute. A. Your Choice: (1) Center (2) Offset left (3) Offset right; B. "Segal" 8 pin tubular; C. 5-pin Tubular; D. 6-pin Tubular; E. 8-Pin Ace.

\$69.95

## SESAMEE DECODER

This tool was designed to decode the exact combination of a sesame padlock without damaging the lock. Detailed instruction included.



\$17.95

## SCHLAGE WAFER

The most fantastic tool you will ever use. This set consists of two base keys and pick. Complete instructions included.

\$27.95

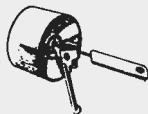

## MD32

Hip Pocket Size, Top Grain Cowhide Leather, Zippered Case, has 32 picks, Tension Wrenches, Broken Key Extractor.

\$69.95

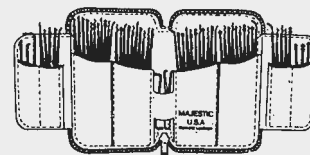
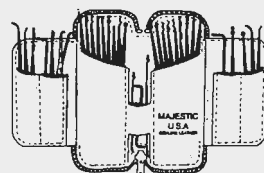

## MD60

Top Grain Cowhide Leather, Zippered Case, has 60 picks, Tension Wrenches, Broken Key Extractor and Warded Master Keys.

\$89.95

Orders over \$100  
Free Shipping  
Catalog \$2.00  
Free with order.  
Sorry, no credit card orders



The law requires all purchases be made in good faith, without make believe or fraud by genuine persons within this industry

Send to  
**Steve Arnold's Gun Room**  
postage & handling \$4.00  
Overseas Surface \$6.00  
Add 20% of total for overseas mail.  
Must be 18 years of age.

P.O. Box 68, Dept. SF05, Dexter, OR 97431; (503) 726-6360

# The Survival Armory

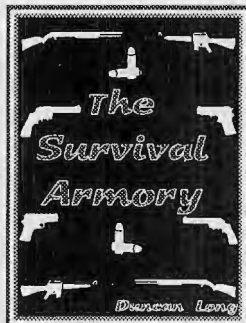

## The Survival Armory The Most Complete Book On Survival Arms EVER

Time and again, whether during a major crisis or a smaller emergency, people have discovered that the only protection available is that which they can provide for themselves.

In such situations,

you'll want the best firearm you can purchase. You can find all the information you will ever need to make that selection in this monumental treatise by Duncan Long. 8 1/2"x11" 270+ pages, illustrated. Shipping in April.

Item No. C-9139.....\$27.95

## The Smith & Wesson Autos From .22s to .45s & Everything In Between

Duncan Long has done it again! It's a comprehensive work on the famous Smith and Wesson automatic pistols.

The book is full of pictures and covers all generations of the automatic including limited production models. It features the latest accessories and enhancements that are currently available and list numerous manufacturers and distributors of the products. The disassembly of the center-fires and .22s are detailed. 8 1/2"x11", 128 pages, illus. Shipping in March.

Item No. C-9135.....\$27.95



## Live To Spend It A Mercenary Guide

For The 90s

In the 1980s there were a number of para-military schools in the United States. Two covert ops veterans started it all, Mitch WerBel with Cobray, and Frank Camper with the Mercenary Association. The "Merc School" was the associations's

training course. Merc School wasn't for wanna-be Rambo's. It was the real thing. Students came from all over the world. The course was mentally demanding and physically cruel. This book is from classes taught at Merc School. All that's missing is the smell of gun smoke and tear gas. 225 pages, 8 1/2"x11", illus., softcover.

Item No. C-9131.....\$29.95

## More New Titles

C-9146 Street Evasion & Escape .....\$16.00

*Evading, Escaping & Other Ways To Save Your Ass When Things Get Ugly.*

C-9145 Hardcore Hayduke .....\$19.95

*More Down & Dirty Revenge Techniques.*

C-9084 Assorted Nasties .....\$19.95

*The Ultimate Handbook On Poisons & Application Devices*

## USMC Training Manuals

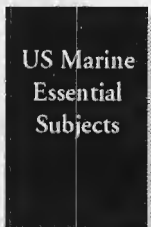

### Marines Battle Skills Training

The Commandant of the Marine Corps has directed that all Marines, regardless of grade, MOS or billet, achieve and maintain proficiency in certain battle skills.

We now have a very limited supply of this manual that contains those battle skills in massive 982 page manual. Covers everything from a proper hair cut to use of improvised explosives. 982 pages, 5 1/2"x8 1/2".

Item No. C-9138.....\$24.95

### U.S. Marine Corps Essential Subjects

Here is the ultimate Marine Corps manual. Covering everything from small unit tactics to advanced ambush techniques. This is the bible of the Corps. Everyone who has an interest in the Marine Corps or military science needs a copy of this almost impossible to find book. 5"x7", 370 page, illustrated.

Item No. C-794.....\$16.95

Credit Card Orders Only call our  
Toll-Free Order Line

**1-800-852-4445**

Customer Service

1-501-862-4984

Fax Number 1-501-862-9671

Allow 2 weeks for delivery



Sorry No C.O.D.'s

Add \$4.95 S&H to all orders plus an additional \$3.00 for orders to Canada.

Other foreign add \$12.00 for first item & \$2.00 for each additional item.

Send Check or Money Order to:

**DELTA PRESS**

P.O. Box 1625 Dept.-SF55

El Dorado, AR. 71731

Send \$3 for a 80 page color catalog (Free with order)

- Compressors capable of refilling firefighters' SCBA (Self-Contained Breathing Apparatus) tanks
  - Night-vision equipment (binocular-style, not rifle-scope-mounted) for spotting hostile gunners targeting firefighters
  - Modern-design (not traditional "Ben Franklin"-style) fire helmets
  - Demolition or concrete-cutting saws and extraction tools of any type
  - Firefighting boots
  - Combat field medical kits
  - Heavy wool socks, any sizes or colors
- Experienced firefighters or paramedics (with military experience and no dependents) can volunteer to assist Sarajevo's fire department by contacting Global Operations Fire/Rescue Services, 900 Second St. N.E., Suite 217, Washington, DC 20002; phone: 202-289-1010; fax: 202-289-1020. ☒

## BELLY GUNS

Continued from page 61

increase to about 0.70 inch (the length of the projectile). Otherwise the wound track is no larger than the bullet's diameter (.357-8 inch). This load has a reputation for overpenetration and it will usually pass through about 21 inches of soft tissue.

That's not effective performance, but there is an excellent and well-proven alternative. Federal Cartridge Co. (Dept. SOF, 900 Ehlen Drive, Anoka, MN 55303, phone 612-421-0646) is one of several manufacturers who produce a version of the so-called "FBI load." Federal's load No. 38G is a 158-grain SemiWadCutter (SWC) Lead Hollow Point (LHP) loaded to +P velocity.

From a 4-inch barrel this ammunition will average approximately 880 fps. Average velocity from 2-inch barrels is 830 fps — only 50 fps less, still moving out and not enough of a drop to alter the round's wound ballistics potential. This bullet will expand to .59 caliber and penetrate about 12.5 inches of soft tissue. Both expansion and penetration are adequate and this load, which recoils sharply, can be recommended without serious reservations for those packing revolvers in this caliber.

We could load this bullet into a .357 Magnum case, which is one-tenth-inch longer than the .38 Special case, and drive it at considerably higher velocities. However, its important to remember that if we drive a hollow-point bullet at too high a



## SWITCHBLADE - AUTOMATIC KNIFE COLLECTORS

### The Automatic Knife Resource Guide and Newsletter

A unique publication for the automatic knife enthusiast, NOW in it's THIRD YEAR! Terrific photos, in-depth articles, maintenance and repair tips, the LATEST trends, resources for ALL kinds of automatic knives, free classified ads and MORE! Send \$10. for single issue or \$30. (\$36. Foreign) for one year [4 issues] subscription to: "THE NEWSLETTER" 2269 Chestnut Street, Suite 212-A, San Francisco CA 94123, USA, Phone/FAX: 415 731-0210.

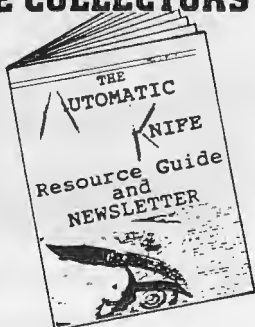

velocity, it will inevitably overexpand and reduce the penetration to an unacceptable depth. It may also fragment to an undesirable extent. There's a correct velocity for every expanding handgun projectile, and it is not the highest velocity possible. The velocity window for effective hollow-point bullet performance is actually very narrow.

Introduced in 1935 by Smith & Wesson and developed by Winchester (with input from Douglas B. Wesson of S&W and renowned reloading authority, Philip B. Sharpe), the .357 Magnum cartridge was conceived as a hunting round, a purpose for which it will sometimes suffice. Non-expanding, heavy bullets driven at high velocity provide the deep penetration required to drop large and often dangerous game animals. In fact, all three of the original bullets introduced with this cartridge were 158-grain solids driven at an astounding 1,450 fps: a round nose, metal point; a solid lead SWC; and a conical, metal-piercing bullet. It was undoubtedly this latter projectile that Dick Tracy employed to crack engine blocks.

With the possible exception of comic strips, .357 Magnum revolvers should never have been applied to law enforcement environments. They are unnecessarily heavy and their propellant charges invariably drive hollow point bullets at velocities which cause them to overexpand and underpenetrate. With properly designed hollow point projectiles, .38 Special velocities are adequate. If you want to increase handgun performance against human targets, then you need to increase the diameter of the bullet, not its velocity.

Federal's bullet seems to be a bit softer than the other makes of 158-grain SWC LHPs. While this assures expansion, and is thus preferred loading, it will cause moderate leading after no more than a box of 50. Bore leading in handgun barrels is best removed by means of a Lewis Lead Remover kit which can be obtained from Brownells Inc. (Dept. SOF, Route 2, Box 1, Montezuma, IA, phone: 515-623-5401).

I prefer the flat Bianchi Speed Strip for carrying an extra five rounds in the pocket, but these lead-alloy bullets deform easily and should be stowed, if possible, where they

**THE  
FIRST  
TEAM**



**OLYMPIC  
ARMS**  
INCORPORATED

620 - 624 OLD PACIFIC HWY SE • OLYMPIA, WA 98513  
TELEPHONE (206) 459-7940 • FAX (206) 491-3447

**NEW from  
OLYMPIC ARMS -  
The OA-93**



**THE FIRST  
TRUE AR PISTOL**

**with no buffer tube, no buttstock**

New from Olympic Arms, Inc., an AR-15 pistol in calibers .223 and 7.62x39mm (Russian short). Our patented design features a unique gas-operated pistol that has no buffer tube, stock, or charging handle.

The OA-93 is 15.75" long, weighs approximately 4.2 pounds and features a free-floated 6" match barrel, custom match handguards, and upper receiver with integral scope mount base. It has virtually **no** recoil or muzzle flash.

**Model OA-93  
in .223 shown  
with optional  
Tasco PDP-2**

***The Book That Could Destroy the Clinton Regime!***

SECRET

FBI Documents Link Bill & Hillary Clinton to Marxist-Terrorist Network



REWARD

\$1000.00 Reward to the First Person Able to Provide Sunset Research Group With Valid Evidence of Any Quotation Cited in This Booklet Being Materially False

problem" --that communist ideals will "absolutely" be instituted in the U.S.

\*Hillary funded Marxist groups under FBI investigation for assassination, espionage & revolution; as well as Marxist terrorists who deliberately maimed Salvadoran children, and traitors who helped the KGB kill our agents (photos of children/dead agent).

\*White House now loaded with Marxist activists. Examples: Bill's Education, Arts, Humanities and Labor leader was an officer in Castro's Venceremos Brigade. Bill's closest friend & advisor (a "Eurocommunist" who long conspired to elect a Socialist President) is now molding Bill's agenda. Plus, proof that U.S./ USSR Communist Parties campaigned for & support Bill.

\*Includes photocopies of Secret FBI papers & 333 footnoted documentations- which have *literally* caused Clinton supporters to break down and cry!

**RECOMMENDED BY SOF** (Oct. 93 SOF, p. 10), this profusely documented intelligence report is terrifying liberals nationwide. Written by an ex-Intelligence officer, it reveals:

\*Bill & Hillary were *both* trained by communists--which Bill insists is "no

**Sunset Research Group  
608 N. West St # 236--SOF,  
Wichita, KS 67203**

1 for \$10, 3 for \$20, 5 for \$25. Includes free P & H. KS res. add 5.9% tax.

# Your Survival Close at Hand!



The PROTEK RING is a new and unique piece of jewelry that automatically transforms into an effective personal self defense unit.

The PROTEK RING is 100% waterproof, dependable, long lasting and durable, meticulously handcrafted in classic sterling silver or vermeil (gold plated) to your ring size.

The PROTEK RING is reliable and easy to use by simply applying pressure to the spring loaded top, automatically arming a hidden, retractable, 1/4" surgical stainless steel blade.

The PROTEK RING gives the wearer a great advantage in case of attack by having the element of surprise on his or her side.

FOR YOUR SELF DEFENSE ORDER YOUR PROTEK RING TODAY. REMEMBER IT'S READY WHEN YOU'RE NOT.

Only \$79.95

Only available from The Goldminer. Satisfaction Guaranteed.  
For defensive purposes only.

#### ORDERING INFORMATION

Send cheque or money order to:

The Goldminer

P.O. Box 89006, 991 King St. West,  
Hamilton, Ontario, L8S 4R5

VISA & MASTERCARD ORDERS call

1-800-387-0523

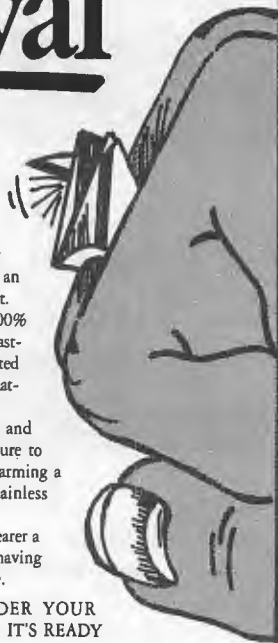

will not knock about.

Introduced in 1907, the .44 Special is an accurate and potentially powerful revolver cartridge which still remains quite popular, especially in the Smith & Wesson N-frame Models 24 and 624 series. The Bulldog can handle more bite than you can. But, remember you have to hit what you aim at; no one that I know of was ever killed by a loud noise.

I usually carry .44 Special loads developed by Black Hills Ammunition (Dept. SOF, P.O. Box 3090, Rapid City, SD 57709; phone: 800-568-6625; fax: 605-348-9827). They use a 240-grain SWC bullet cast from a hard lead alloy (92% lead, 6% antimony and 2% tin). Driven by a moderate charge of a fast-burning propellant (appropriate for short handgun barrels), this projectile will reach almost 700 fps in the 1.75-inch barrel of my modified Bulldog. This bullet does not expand, but it generates only mild recoil and penetrates deeply while making a .44-caliber hole.

Skeeter Skelton's favorite handloads for this caliber were the Lyman-Keith No. 429421 SWC bullet over either 7.5 grains of Hercules Unique or 17.5 grains of Hercules 2400. Both are stout loads, but the Bulldog can handle 7.5 grains of Unique, if the shooter can.

#### Stuff Not Into Lousy Leather

Nothing will compromise a small revolver's concealment potential or presentation into the firing position more quickly than stuffing it into a poorly designed holster. Or worse yet — as some gunwriters have suggested — no holster at all. For example, some of these armchair commandos have stated that because the Centennial's hammer mechanism is concealed within the frame, it is ideally suited to — and was in fact designed for — carrying loose in a coat pocket and, if the situation required, firing from that location. The fact that some brain-dead couch potato may have actually pulled off such a stunt without managing to set himself on fire doesn't make it any less ludicrous. In the real world, combat handguns should be fired from the Weaver position with emphasis on the flash front-sight picture. For those who have been properly trained for such confrontations no further elaboration is necessary. Others should seek

# TITANIUM

"The COMPETITIVE edge..."

\$21.95

Fits 1911 pistols  
.45 ACP &  
.38 Super

\$34.95 Fits AR-15 & M/16

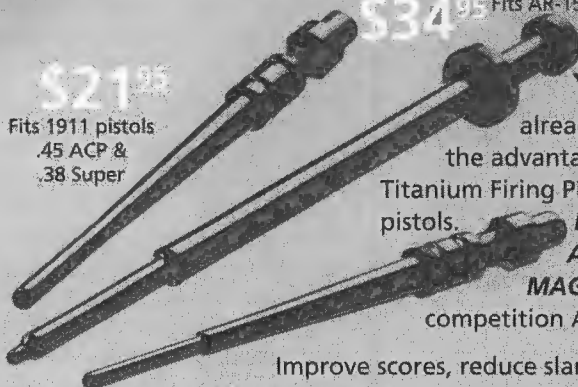

You have already discovered the advantages of our Titanium Firing Pins for 1911 pistols. NOW YOU CAN ADD THE SAME MAGIC to your competition AR-15® & M/16®

Improve scores, reduce slam fires, discover what QUICK really means!  
Cut lock time . . . & get on to the next target!

Proudly Made in the U.S.A.

Retail order desk:  
1-800-444-1911  
(Add \$3.00 S/H per order)



Quality Machining

INCORPORATED

"OUR NAME SAYS IT ALL"

P.O. Box 129 • Sherwood, Oregon 97130

24 HOUR FAX LINE FOR ORDERS & DEALER INQUIRIES: 1-503-590-1630  
(Product Information: 1-503-590-1630)

advice and training from instructors with the right credentials.

Small revolvers are best concealed by inside-the-pants or ankle holsters. In 1967, Bruce Nelson (Dept. SOF, Combat Leather, P.O. Box 8691 CRB, Tucson, AZ 85738, catalog \$3) designed his justifiably well-known No. 10 Summer Special. By now, a much copied design (both acknowledged and otherwise), it corrected problems inherent at the time in inside-the-pants types. A metal-lined top band permits reholstering with ease. The belt retaining strap is secured by a one-way "pull the dot" snap. Fabricated from thin leather and precision hand molded (as are all Nelson's holsters), the Summer Special minimizes bulk inside the pants while its "rough out" texture allows the leather to adhere to clothing for position stability. This is normally a strong-side holster, but it can be fabricated with the retaining strap in the vertical position and thus the holster can, in this instance, be worn cross-draw also.

Safariland's (Dept. SOF, 3120 E. Mission Blvd., Ontario, CA 91761; phone: 800-347-1200, fax: 800-366-1669) synthetic holsters to a large extent look like leather, but wear like iron. I have experience with two of their inside-the-pants type holsters that I can recommend highly, the J Hook (catalog No. 027) and the Inside The Belt II (catalog No. 21).

My favorite ankle holster is made by Milt Sparks Holsters Inc. (Dept. SOF, 605 East 44th, No. 2, Boise, ID 83714; phone/fax: 208-377-5577; catalog \$3), a small custom shop that has been highly regarded by such notables as Jeff Copper, Ken Hackathorn and the late Elmer Keith and Mel Tappan. Milt Sparks Ankle Concealment Rig consists of a firm, contoured leg strap to prevent shifting, which is lined with dense sheepskin wool that conforms to your ankle with use. The holster itself is meticulously hand-molded from top-quality cowhide to the weapon it is meant to carry to provide excellent retention without the use of safety straps. After 23 years, and now under the direction of Tony Kanaley, they are still doing it right. I use their ankle holster several times a week and it is the most comfortable I have ever worn.

Fanny pack holsters are now so ubiquitous that they actually focus

# NIGHT VISION



**MPN 95K Generation II Weapon Sight**  
3.5X Image Magnification • Automatic Brightness Control  
Bright Source Protection • 60,000X Light Gain (Max.)  
Uses standard 9 volt battery  
**\$1295.00**

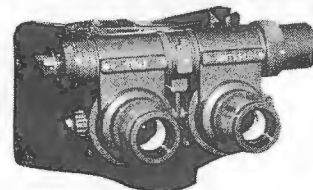

**MPN 50K Starlight Goggles**  
40° Field of view • Detachable Infrared Illuminator • 50,000X Light Gain (Max.)  
Uses standard "C" battery **\$1955**

**Moonwalker**  
Palm-sized viewer • 1 X Magnification.  
6000 X Light Gain (Max.) •  
Only 5" long • Detachable Infrared Illuminator **\$495.00**



**MPN 60K Generation II Plus Viewer**  
5.2X Image Magnification • Manual Brightness control • Bright Source Protection • 60,000X Light Gain (Max.) • Sharp, Hi-Contrast Image  
Uses standard 9 volt battery.  
**\$895.**



**30 DAY MONEY BACK GUARANTEE ~ ONE YEAR WARRANTY**

We carry the entire line of Russian Night Vision Systems, Goggles, Binoculars, Gyro Stabilized Binoculars and Weapon sights, call for information.

All of our Night Vision Systems are brand new, not reconditioned, with new Image Intensifiers for years of dependable service. All units include field cases, batteries and full instruction manuals. These units are made in Russia and are manufactured to Military specifications.

**CALL TOLL FREE 1-800-841-3245**

Or send check or money order plus \$9.00 S&H to:  
**Starlight Imaging Systems Inc.**

17027 West Dixie Highway Suite 103  
North Miami Beach, FL 33160

Phone: (305)949-0089

Fax: (305)949-0075



## Don't Miss A Single Issue SUBSCRIBE NOW!



Subscribe now and you can enjoy interesting and informative articles about machine guns and other Title 2 firearms but that's not all... **Machine Gun News** keeps you informed of recent federal firearms laws and rulings, and helps you understand the red tape and confusion surrounding them. Plus, whether it's differences in parts, sources for magazines, or functioning problems, **Machine Gun News** shows you how to find solutions. **Machine Gun News** also contains display and classified advertising which offer firearms, parts and accessories that you can't find anywhere else. This is a unique and indispensable magazine for the firearms enthusiast. Why not subscribe today?

The regular yearly subscription price is \$34.95. But, for a limited time, you can have a full year's subscription for only \$29.95. Don't wait. Mail the coupon below now! Or call (501) 525-7514.

Yes! Start my subscription to Machine Gun News. I'll receive 12 information packed issues for just \$29.95! (Offer good in U.S.A. only. Foreign subscribers send for rates.)

M/C, Visa, AmEx # \_\_\_\_\_

Exp. \_\_\_\_\_

Check/Moneyorder enclosed

To ensure your privacy Machine Gun News is mailed with a protective cover. Watch for your first issue in 4-6 weeks!

name \_\_\_\_\_

address \_\_\_\_\_

city \_\_\_\_\_

state \_\_\_\_\_ zip \_\_\_\_\_

**Send to:** Machine Gun News  
P.O. Box 759, Dept SF1,  
Hot Springs, AR 71902

**Or call:** (501) 525-7514

**Fax order line:** FAX5015257519

**\*\* THE \*\***  
**COMMON SENSE GUIDE**  
**FOR THE**  
**COMING STORMS**

**BAD TIMES**  
**Good News**

A Practical Guide To Preparedness  
 And Survival



BILL YATCHMAN

19 Topics Covered, Including:

**GOLD, SILVER, WATER STORAGE,  
 GASOLINE STORAGE, SOLAR,  
 EMERGENCY APPLIANCES, RURAL  
 RETREAT, COMMUNICATIONS,  
 MEDICAL, BURYING GOODS,  
 FIREARMS, CALIBER SELECTION,  
 & MUCH, MUCH MORE.**

**\$11.95 TOTAL**

Includes 1st Class Postage

**GREENTREE STOCKS**

2756 W. HWY. 89-A

SEDONA, ARIZ. 86336

1-602-282-6547

**NOTICE TO  
 CALIFORNIA RESIDENTS**

*Some firearms advertised in this magazine  
 may or may not be lawful for sale in California.*

*Those specifically not allowed for sale in California are:*

**A. All of the following rifles:**

1. Avtomat Kalashnikovs (AK) series
2. UZI and Galil
3. Beretta AR-70 (SC-70)
4. CETME C3
5. Colt AR-15 series and CAR-15 series
6. Daewoo K-1, K-2, Max 1, and Max 2
7. Fabrique Nationale FN/FAL, FN/LAR AND FNC
8. FAMAS MAS223
9. Heckler & Koch HK-91, H-93, HK-94 and PSG-1
10. MAC 10 and MAC11
11. SKS with detachable magazine
12. SIG AMT, SIG 500 Series, and SIG PE-57
13. Springfield Armory BM59 and SAR-48
14. Sterling MK-6 and SAR
15. Steyr AUG
16. Valmet M62, M71S and M78
17. Amalite AR-180 Carbine
18. Bushmaster Assault Rifle (armgun)
19. Calico M-900 Assault Carbine
20. Mandall THE-TAC-1 Carbine
21. Plainfield Machine Company Carbine
22. PJK M-68 Carbine
23. Weaver Am Nighthawk

**B. All of the following pistols:**

1. UZI
2. Encom MP-9 and MP-45
3. MAC 10 and MAC 11
4. INTRATEC TEC-9
5. Mitchell Arms Spectre Auto
6. Sterling MK-7
7. Calico M-900

**C. All of the following shotguns:**

1. Franchi SPAS 12 and LAW 12
2. Gilbert Equipment Company Striker 12 and SWD Street Sweeper
3. Encom CM-55

**SOLDIER OF FORTUNE MAGAZINE**

attention on that fact that you are packing a rod. I have recently been experimenting with the Gun Mate belt pack holster made by Michaels of Oregon. Much smaller than a fanny pack, it attaches to your belt and can be worn either strongside or in the crossdraw position. The handgun is held in a rear compartment sealed by a Velcro-type flap. The front compartment can be used for a wallet, handcuffs or other items. Both compartments are sealed by a double-pull zipper. A small front pocket with a Velcro-type flap will hold keys and other small items. Don't expect a "par" time drawstroke from this rig, but it provides excellent concealment.

These are the belly guns and the associated equipment most often carried by armed professionals. Don't expect me to select one of each for you. That's up to you. To one degree or another I have used everything mentioned. I've discussed nothing that is without merit. The losers have been left out of this article. You can read about how great they are in the popular gun press. ✕

**MEXICO MAYHEM**

*Continued from page 52*

against the rebels and the townspeople were happy to see the army, abuses notwithstanding.

Although claiming some 2,000 rebels, from all appearances the Zapatistas numbered about 1,000 trained, operational troops, many poorly armed, with little ammunition. One dead rebel was found armed only with a hand-carved wooden rifle, a bayonet strapped to the end — even though the rebels had good radio communications and many wore military style uniforms and combat boots.

The Mexican army, on the other hand, was very well-equipped. Mexico makes its own uniforms and LBE except for U.S. combat packs and helmets. Individual weapons were either H&K G3s, with M16s in evidence among the *federales* and a smattering of FN FALs. The predominant sidearm was the Beretta M92, with local police carrying assorted .38 revolvers.

As we go to press the rebels are holed up in Guadalupe Tepeyac. A

cease-fire has been declared and accepted by all parties. Mexican President Salinas has offered a general pardon and amnesty to all rebels who lay down their arms. Commandante Marcos replied to this by stating, to the press, "Pardon us from what? For not dying of hunger? For not keeping quiet in our misery?" Clearly, the two sides have a long way to go to resolve their differences. To that end, a peace commission has been appointed, consisting of special commissioner Manuel Camacho Solis and Bishop Ruiz. Preliminary dialogue addressing the guerrillas' demands is underway.

The government has met several of the Zapatista conditions by halting random bombing of the Selva Lacandon and recognizing the Zapatistas' right to exist — but stopped short of withdrawing government troops. Former Chiapas Governor Absalon Dominguez was released in mid-February.

The official casualty figures were about 124 rebels killed and 100-300 wounded; 178 were arrested on suspicion of involvement but all save 30 have been released. Additionally, 50 soldiers were reported killed and one Mexican journalist was shot.

Let us hope the Mexican government defuses the situation by addressing the legitimate grievances of the Indians. If they do not, continued fighting is inevitable as more Indians will take sides with the Marxist Zapatistas, seeing no other way to address the injustices they are subject to.

I wish I could report "and they all lived happily ever after," but the jury is still out on Chiapas, and the EZLN still has 500 pounds of stolen dynamite stashed somewhere.

*Robert Walchli is a California-based photojournalist and frequent photo contributor. This is his first article in SOF. ✕*

**I WAS THERE**

*Continued from page 14*

was a VC chicken, so we popped/plucked/boiled him in a steel pot, and voila: hot chow! Best chop chop in days.

Word came up to the point that a resupply chopper was inbound.

Soon came the *whop-whop-whop* of a slick, approaching low and hot. We popped smoke and as the ship flared for landing, Fee and I broke cover and headed for our resupply. We were about 10 meters from the Huey when *kaboom!* I felt myself tumbling, enshrouded in a cloud of acrid black smoke. Ah shit, I knew I was hit, but what about my *numba one* scout, Fee? As the smoke cleared and I regained some senses, I became aware of my friend Fee holding me, softly crying, "Sully, Sully ..." We had become tight and it hurt him deeply that I was hit, while right beside me he was unscathed. Fee helped me sit up, and I checked myself for damage. My right leg was shattered, the jungle boot blown nearly off my foot.

Hot frag and debris had peppered me. Soon Doc Anderson was applying compresses and I was placed into the supply slick for evacuation. I had only a brief opportunity to make one last connection with a few of the brothers ... a quick touch ... a word of encouragement ... see you back at base ... be back in a week or two ... But as the Huey powered up for takeoff, as I watched the best friends I'd ever known fade from view on my last hot departure from that terrible yet beautiful place, I knew it would be a long time, if ever, before we would meet again.

What I did not know was that after 25 years I still would miss that camaraderie, that sense of brotherhood, the love that only the fires of war can forge.

The 4th of the 39th had put it on the 261A big time, just like it was supposed to be done. We took four wounded, while killing more than 100 VC. Their base camp and combat effectiveness had been destroyed. Colonel Hackworth would later refer to that fight as the most satisfying operation of his career. In his five months of command, he had crystallized our once ragtag outfit into an effective counterinsurgency force.

It was my last combat operation. After 20 months of hospitals, surgeries and various repairs, I was retired in grade E4, but I had been at the top with the 4th/39th! ✕

"INCREDIBLE" Guns Magazine "ABSOLUTELY AMAZING" Guns & Ammo "BEST LEGAL FULL AUTO" Soldier of Fortune

**UNLEASH "HELL-FIRE"**

Do you own any Semi-Automatic and want to Rock 'N Roll! Well, the all-new "HELL-FIRE" Trigger System is here! You won't find anything closer to a "Select Fire" Conversion, and it's LEGAL! The unit is installed externally in seconds. It does not interfere with the normal operation of trigger. When engaged, you may fire bursts, to emptying complete magazines at a full automatic rate accurately and legally! Hurry and get yours now before it's too late! Minimum age to order - 18 years.

MODEL HFS (UNIVERSAL) FOR MOST SEMI-AUTOMATICS **\$2995** COMPLETE PREPAID

MODEL HFS 22 FOR 10/22 **\$1995** COMPLETE PREPAID

**PHONE ORDERS ONLY (303) 249-2694**  
OR SEND CASHIER'S CHECK OR MONEY ORDER TO:  
(PERSONAL CHECKS DELAY ORDER)

**HELL-FIRE SYSTEMS INC.**  
U.S. Pat. & Other Patents Pend. P.O. BOX 549, OLATHE, CO 81425  
Colorado residents add 4% Visa/MC

10/22 • TEC 9, 22 • SP 89 • M1 GARAND • MAC 11/9 • APS  
AR15 • MINI 14,30 • M1A • 30 CARBINE • AKS • DAEWOO • FNC • HK 91, 93, 94 • AT 9 • CAMP 9, 45 • SKS • FAL

"THE BEST" American Survival Guide LIFETIME WARRANTY

## WHEN YOUR TYPICAL DAY ON THE JOB IS ANYTHING BUT TYPICAL.

LONDON BRIDGE TRADING CO. IS A *manufacturer* OF TACTICAL LOAD-BEARING AND OTHER SPECIALIZED EQUIPMENT FOR: BUILDING ENTRY, SNIPER/COUNTER-SNIPER, SURVIVAL, ESCAPE AND EVASION.

OUR GEAR IS USED WORLDWIDE

BY MILITARY SPECIAL OPS UNITS, GOVERNMENTAL AGENCIES AND SPECIAL LAW ENFORCEMENT UNITS. RETAIL AND WHOLESALE ACCOUNTS. Send \$2.00 for our extensive catalog.

STORE HOURS: M-F 9:00-7:00.  
SAT. 12:00-6:00. • 804-498-0207



### LONDON BRIDGE TRADING CO. LTD.

3900 BONNEY RD., STE. 107  
VA. BEACH, VA 23452 USA

1-800-229-0207  
FAX 804-498-0059

## ADVERTISERS INDEX

Amazing Concepts .....	17
Automatic Knife .....	
Resource Guide .....	66
Collector's Armoury .....	64
Crown Specialty .....	28
Danner Shoe MFG .....	25
Delta Press .....	66
Doubleday Military Book Club .....	20-21
Excalibur Enterprises .....	26
Executive Protection .....	Cover 3
The Goldminer .....	68
Greentree Stacks .....	70
Intelligence Inc. ....	8
London Bridge Trading Company .....	71
Machine Gun News .....	69
Michigan Body Armor .....	17
National ID Center .....	13, 18
Olympic Arms .....	67, Cover 4
Optimum Training Systems .....	9-12
Orpheus .....	71
Pachmayr .....	17
Paladin Press .....	7
The Gold Miner .....	68
Quality Machining Inc. ....	68
S & K Products .....	17
S.T.A.N.O. ....	19
SOF Conventioneer .....	15
Sonic Technology .....	27
Southern Ordnance .....	Cover 2
Starlight Imaging Systems .....	69

Steve Arnold's Gunroom .....	65
Sunset Research Group .....	67
U.S. General Technology .....	29
<b>SUPPLY LOCKER</b>	
Cutlery Shoppe .....	74
David Steele Ent. Inc. ....	73
Delta Arms .....	72
Eden Press .....	74
Global Sales .....	75
Global School Of Investigation .....	75
Greene Military Distributors .....	74
Gun Parts Corporation .....	74
Hitek .....	73
JTR Labs .....	74
LA Law Enforcers .....	73
M.O.R.O. International .....	74
Matthews Police Supply .....	73
National ID Center .....	72
North American Integrated .....	72
Outback Mercantile .....	75
Politically Incorrect Graphics .....	72
Professional Career Development .....	73
S & K Products .....	72
Silvermans .....	73
U.S. Cavalry .....	74
USI Corporation .....	72
WW2 Products .....	72
Westbury Sales Co. ....	73

ADVERTISING POLICY: Publication of any advertisement in Soldier Of Fortune Magazine is not an endorsement of the advertiser of the product(s) or service(s) advertised, either by SOF Magazine or by the Editor and Publisher.



**PHOTO CARD KITS**

MONEY BACK GUARANTEE!

Our Professional quality, laminated photo cards will amaze your associates! We provide the cards, plastic laminate and easy instructions! You provide only a photo. Your photo Card can be finished in the privacy of your home! The result is a distinctive, professional system! The highest quality cards in the US! Lost your original card? Replace it now!

**BAIL ENFORCEMENT**  
SPECIAL IDENTIFICATION



**BAIL ENFORCEMENT AGENT**

No. 77903

**only \$4.95** C203 Bail Enforcement Agent

Select From These Kits:

- |   |   |
|---|---|
| C04 <input type="checkbox"/> Bounty Hunter          | C06 <input type="checkbox"/> Mercenary            |
| C13 <input type="checkbox"/> Special Investigator   | C41 <input type="checkbox"/> Intelligence Officer |
| C45 <input type="checkbox"/> MAC-V (CIA), #1        | C212 <input type="checkbox"/> Official Press      |
| C60 <input type="checkbox"/> MAC-V (CIA), #2        | C46 <input type="checkbox"/> Special Forces       |
| C14 <input type="checkbox"/> OCB                    | C47 <input type="checkbox"/> Seal Team            |
| C52 <input type="checkbox"/> Air America Pilot      | C18 <input type="checkbox"/> Pilot                |
| C01 <input type="checkbox"/> Press Card             | C03 <input type="checkbox"/> Security             |
| C50 <input type="checkbox"/> Phoenix Program        | C17 <input type="checkbox"/> Int'l Drivers Permit |
| C49 <input type="checkbox"/> Delta Force            | C11 <input type="checkbox"/> Private Investigator |
| C25 <input type="checkbox"/> Parachutist, Certified | C02 <input type="checkbox"/> Bodyguard            |
| C26 <input type="checkbox"/> SCUBA, Certified       | C12 <input type="checkbox"/> Security Consultant  |
| C07 <input type="checkbox"/> Weapons Specialist     | C51 <input type="checkbox"/> Special Operations   |

Any Three Only **\$11.95**

Any Six Only **\$19.95**

**NIC Law Enforcement Supply**  
500 Flourney Lucas Rd. Box 5950-SV  
Shreveport, LA 71135-5950

COLOR CATALOG \$2.00 OR FREE WITH ORDER

Name \_\_\_\_\_

Address \_\_\_\_\_

City/State/ZIP \_\_\_\_\_

Card # \_\_\_\_\_ Exp. Date \_\_\_\_\_

VISA M/C CHK MO 24-hour order No. (318) 688-1365  
FAX # (318) 688-1367

A SIMPLE REACTION TO AFFIRMATIVE ACTION



Show support for your heritage!  
Black T-shirt - high-quality design in full color  
S - XL \$15 / XXL \$17 / U.S. add \$3 S&H  
Foreign add \$6 S&H / Ca. res add 8 1/4% tax  
Catalog available / Send ck or money order to:  
**PIG (Politically Incorrect Graphics)**  
P.O. Box 2147, Orinda, CA 94563  
Ph: 510-531-5028 / Dealer inquiries welcome

**HK SPARE PARTS**



CATALOG \$2.00  
**DELTA ARMS Ltd.**  
Box 1100-F Delta, Utah 84624  
(801)864-3232 FAX 864-3331

**NIGHT VISION**  
ELECTROPTICS  
NEW THIRD GENERATION NIGHT VISION SYSTEMS

**SCOUT PVS-7B BLACKCAT**  
POCKETSCOPE GOGGLE GEN III 1X LENS I.R. LIGHT MINI-WEAPON SIGHT



**\$3,450. \$3,995. \$4,850.**  
RECONDITIONED UNITS AT OVER 50% SAVINGS

**PVS-5 NIGHT PVS-7A**  
GOGGLE GEN II 1X LENS I.R. LIGHT STALKER POCKETSCOPE GOGGLE GEN II AND III C-MOUNT I.R. LIGHT



STARTING FROM **\$2,495. \$1,395. \$1,995.**

(916)784-3316 / (916)774-7525  
SEND \$1.00 FOR A CATALOG TO:  
**NORTH AMERICAN INTEGRATED TECHNOLOGIES**  
1911 DOUGLAS BLVD., SUITE 85-104  
ROSEVILLE, CA 95661

Don't get fooled by Frauds  
100% GUARANTEED  
Anabolic Muscle Building

**STEROIDS**  
Replacement

This product is to be taken orally.  
No harmful side effects.

S&K Performance Product **Boron!**  
Can dramatically increase your  
**Testosterone levels up to 300%!**  
Higher Testosterone means faster, easier muscle  
growth! Greatly enhance your physical  
appearance literally sculpting your own body with  
huge healthy, hard muscle.

Get that lean awesome body builder physique  
now with one 3 month cycle for only **\$15.95!**

If you are not completely satisfied  
with the growth you obtain within 15 days  
return it for a full refund.

**Money back guarantee!** To get your  
super anabolic growth cycle from:  
S&K Performance Products

Order Now!!!  
**\$15.95+shipping** VISA

**1-800-398-6946**

24hrs. 7 days a week

C.O.D.'s welcome add \$4.00 shipping.

Check or money order send with

**\$15.95+shipping** and handling to:  
S & K Labs, 2637 E. Atlantic Blvd. Suite 101,  
Pompano Beach, FL 33062

**THE HOUND DOG**

**Sniffs Out Hidden Transmitters**

Throughout the world today, corporations, professional men, and businessmen are spending millions annually to insure privacy in their offices and homes where important plans and policy making decisions are discussed and formulated. The "HOUND DOG" is a wise investment for anyone who has reason to believe that an eavesdropping device is now hidden, or may be hidden in the future, in either home or office. No radio transmitter, no matter how well it may have been hidden, can escape detection by the "HOUND DOG".

The "HOUND DOG" is an advanced electronic instrument designed for the sole purpose of locating hidden transmitters. An average size office or room can be thoroughly searched in only a matter of minutes. The "HOUND DOG" sniffs out any transmitters hidden in pictures, walls, desks, chairs, etc., regardless of their operating frequency.

The "HOUND DOG" is simple to use. Single knob adjustment calibrates the meter and any transmitter signal received is indicated by the meter movement. By simply sweeping the probe past walls, chairs, pictures, desks, etc. the presence of any transmitter will cause a rise in the meter reading. The meter reading will continue to rise as the probe approaches the transmitter.

We believe you will find the "HOUND DOG" outperforms most other units selling for several times the price. This item has been built since 1962. Each one is backed by a 3-year warranty by us.

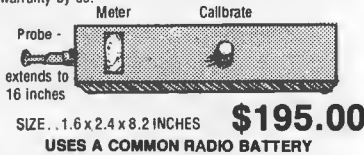

**Super Powerful FM TRANSMITTER**  
Many times more powerful than other transmitters.  
Transmits up to 1/4 mile to any FM radio — Easy to Assemble Kit — up to 9V battery (not incl.)  
**\$19.95**

Call 407-725-1000 or send \$195.00 plus \$5.00 shipping for Hound Dog and \$19.95 and \$1.00 shipping for FM Transmitter to USI Corp. P.O. Box SF-2052, Melbourne, FL 32902. COD's OK. For a catalog of transmitters, voice scramblers & other specialty items enclose \$2.00 to USI Corp.

See our collection on color VIDEO



**SUB IRON CROSS WOUND**  
Your choice any one-\$10.00 or all 3-\$25.00. All are full size, not miniatures. These made from originals. Your choice WWI or WWII (state choice). We have most complete stock of WWII German badges-caps, etc. in U.S.  
**WWII U.S. CAP**  
U.S. Officer's Cap (new from original U.S. maker). Tan with brown leather visor, chin strap and U.S. Eagle pin. State size S, M or L, \$68.00. Have few Olive Drab, Wool \$74.00

**GENERAL'S CAP**  
State S, M or L Size=\$88.00. Shoulder Boards, Set=\$31.00. Collar Tabs, Set=\$18.00. Complete, Knights Cross=\$21.00. The Complete Set, IN STOCK. ALL 4=\$137.00

**AFRIKA-KORP. CAP & GOGGLES**  
German 1942 Mfg. ORIGINAL sand & dust goggles. Still in their pocket pouch. Tan Ofc. caps-New REPLICA, State S, M or L size, Both Only \$39.00

**U-BOAT CAPTAIN'S CAP**  
White top Gold insignia and visor braid. Leather chin strap. State size wanted \$110.00 Knights Cross with ribbon and oak leaf with swords \$21.00

**PANZERFAUST ANTI-TANK WEAPON**  
Full Size Movie Makers Replica \$185.00+\$10.00 handling

For the back or your Jack-et...Flying Tigers BloodChit Patch 7" X 11" good reproduction-\$25.00 ("your choice of American or Chinese flag).  
VIDEO — our collection w/prices...on VHS VIDEO only \$20.00 postpaid.(Free w/any \$25.00 + order.

W.W.#2 Ltd. Box 2063-F St. Louis, Mo. 63158

# CAPITALIZE ON CRIME

**IT CAN PAY HUGE PROFITS!**

**EARN HUNDREDS DAILY!**

CRIME PREVENTION IS A MULTI-MILLION DOLLAR BUSINESS!!

OUR DEVICES SELL LIKE CRAZY!

**FREE WHOLESALE CATALOG**

WE SELL SECURITY PRODUCTS WORLDWIDE.

WE CARRY THE BEST LINE OF SECURITY SPRAYS, STUN GUNS, PERSONAL SOUND ALARMS, BURGLAR ALARMS AND MUCH MORE. WE SPECIALIZE IN OFFERING THE BEST SECURITY PRODUCTS AT THE VERY BEST WHOLESALE PRICES. \$3.00 S&H.

<b>KEY CHAIN SPRAYER</b> RETAILS: \$19.95 SAMPLE: \$9.95	<b>POCKET PEN SPRAYER</b> RETAILS: \$14.95 SAMPLE: \$6.95	<b>PERSONAL SOUND ALARM</b> 130 DECIBALS RETAILS: \$39.95 SAMPLE: \$14.95
<b>ELECTRONIC STUN GUNS</b> RETAILS: \$69.95 SAMPLE: \$29.95	<b>INFRASONIC BURGLAR ALARMS</b> RETAILS: \$429.00 SAMPLE: \$249.00	

**CALL OR WRITE TODAY!**  
WE ARE COMMITTED TO YOUR SUCCESS. CRIME DOES NOT WAIT! WILL YOU?

**L.A. LAW ENFORCERS**  
1005 No 1st St., Dept. SOF  
Yakima, WA 98901  
(509) 457-9033 FAX (509) 575-1875

## Become a gun repair expert!

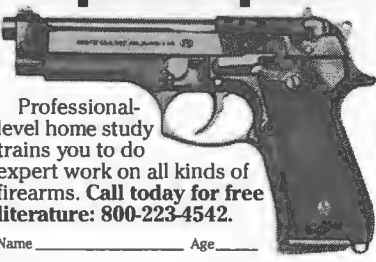

Professional-level home study trains you to do expert work on all kinds of firearms. Call today for free literature: 800-223-4542.

Name \_\_\_\_\_ Age \_\_\_\_\_  
Address \_\_\_\_\_ Phone (\_\_\_\_) \_\_\_\_\_  
City \_\_\_\_\_ State \_\_\_\_\_ Zip \_\_\_\_\_

School of Gunsmithing, Dept GF171  
6065 Roswell Rd., Atlanta, Georgia 30328

## LEGIONNAIRES SURVIVAL BOOT KNIFE

ONLY \$12.95  
Add \$1.05 Hndl.



Model K-99-A

Double edge 440 stainless steel blade. Full tang one piece construction. Leather sheath with quick release snap and metal boot/belt clip. **Money Back Guaranteed If Not Fully Satisfied!!**

WESTBURY SALES CO. DEPT BK-05-SF  
156 Post Avenue, Westbury, New York 11590

## GENUINE BRITISH MILITARY KIT

- BRITISH DPM SAS SMOCKS
- BRITISH DPM PARA SMOCKS
- BRITISH DPM JACKETS ('68 PAT)
- BRITISH DPM TROPICAL SUITS
- BRITISH WOOLEY PULLY'S
- BRITISH DENISON SMOCKS
- BRITISH WEBBING PLCE, '58, '37
- BRITISH DPM DESERT SUITS
- BRITISH RUCKSACKS
- BRITISH DRESS UNIFORMS
- BRITISH POLICE KIT
- BRITISH PARA/SAS BERETS/BADGES
- BRITISH G10 ARMY WATCHES
- BRITISH W.W. II KIT



Orders dispatched by air mail £17.99 per order Visa/MC accepted.

Send for FREE catalogue to: Silverman's (SOF), Mile End, London E1 4PS. England  
Phone 011-44-71-790-5257  
Credit card orders 0717-900-900  
Fax 011-44-71-791-0008

NAME \_\_\_\_\_  
ADDRESS \_\_\_\_\_  
CITY \_\_\_\_\_  
STATE/ZIP \_\_\_\_\_

## BULLETPROOF VEST

Will stop the .357 Magnum, 9mm and 00 Buck. Meets and exceeds "Threat Level II-A" tested in accordance with the NILECJ-STD-0101.01. Weighs 2¾ lbs. Fits easily under T-shirt.



Front & Back Protector \$220  
Detachable Side Panels \$45  
Chest Trauma Plate \$35

Officially tested by the U.S. Government Edgewood Arsenal at the Aberdeen Proving Grounds under the U.S. Department of Justice Standards. State height, chest and waist measurements.

**MATTHEWS POLICE SUPPLY CO.**  
(a division of David Matthews, Inc.)  
P.O. Box 1754 Dept. SF  
Matthews, N.C. 28105  
Ph. (704) 847-8793 FAX: (704) 847-4447

## THE BODY SCULPTOR

Develop the body you've always dreamed of having. Add inches to your chest, arms, and thighs. Sculpt your stomach, buttocks, and calves. The Body Sculptor tones muscles, and relieves stress and tension. Adjustable electrical impulses work your muscles more effectively than regular exercise. It's medically proven, effortless and safe! Use it at home, in the office, traveling, even while reading or watching T.V. Results guaranteed in 30 days or your money back!



Your unit includes the following: • 24 hr. customer service • Free AC wall adapter • Complete instructions • 5 year Iron-Clad warranty • Free Carry Case • 30 day trial period

A. BM-1004, 6-pad model w/AC adapter, \$219  
B. BM-1006, 8-pad model w/AC adapter, \$259  
C. BM-1008, 12-pad model w/AC adapter, \$359  
D. BM-1012, 16-pad model w/AC adapter, \$459  
E. BM-1014, 18-pad model w/AC adapter, \$499

\*Add \$10 for ship. & handling • CA res. add 7.75% tax\*

**Call Now For Immediate Delivery!**  
1-800-428-7825, Ext. 33 (U.S. & Canada)  
or send check/money order to: David Steele  
64 Lehigh Aisle, Irvine CA 92715

These Are The Finest Electronic Muscle Stimulators Available Anywhere!

## MILITARY NIGHT VISION RIFLE SCOPES

BRAND-NEW \$995! Plus \$12.00 S&H  
FROM ONLY

Compare with U.S. units selling brand-new at \$5,000.00 and more!

Own the Starlight technology used by the KGB, Russian Commandos and Military for night surveillance and combat! **Feather light; U.S. mount; adjustable windage & elevation; optional infrared illuminator pin-points targets with invisible light!**





Investigate our full line of superior-quality, low-cost Night Vision devices.

**30-Day Money-Back Guarantee!**

Use of this product for hunting & other activities may not be legal in your area

Californians add 7.75% sales tax

**Call Now: 1-800-54-NIGHT**  
**HITEK**  
490 El Camino Real, Redwood City, CA 94063

MasterCard  
VISA

# STEROIDS

## D-BALL TEST DECA JET

Anabolic Steroids increase Testosterone levels to Build Muscle Mass and Strength

Now there is a safe and effective replacement for steroids. Boron\*. Tens of thousands have used Boron from JTR Labs to successfully replace steroids without the harmful side effects. *Guaranteed.* Check out these results. All from Boron users.

"...20 pounds of muscle in three months..." Willie Beck III. AL  
 Terry Goetz. VT. Put 90 pounds on his bench. "...two inches in my chest..." J. Ramsey. TX  
 "...its the extra edge I needed..." Charles Walters, Military  
*All these amazing gains using Boron.*

For your own Huge Increases - Order your 3 month cycle of Boron today. Only \$19.95, shipping included. Blow away your competition and order now.

\*Boron is a safe, 100% natural nutrient

COD's, Credit Card, Catalog orders call: 1-800-962-4769....ask for dept.#606

Order lines open 24 hours 7 days a week  
 Send check or money order to:



**JTR LABS**  
 10230 Bach Blvd.  
 Dept.#606  
 St. Louis, MO 63132



HOME OF THE LIFETIME GUARANTEE

**WARNING:** Accept no imitations or copy cats. JTR Labs, gives you the highest quality Boron. For 5 years. Unlimited Guarantee.

# GUN PARTS CORPORATION

SUCCESSORS TO NUMRICH ARMS

## THE WORLD'S LARGEST GUN PARTS SUPPLIERS

PRESENTS ITS NEW #18 CATALOG

Featuring an inventory of over 450 million gun parts we have for sale. A 650+ page catalog with exploded drawings that are invaluable to the gunsmith or hobbyist. Commercial, military, antique and foreign gun parts (many exclusively available from us) are listed and priced along with accessories, surplus & specialty items. A veritable encyclopedia of gun parts, this catalog will pay for itself time and time again with information and time saved in identifying parts.

U.S. \$5.95 SURFACE FOREIGN - \$10.95  
 send AIRMAIL WRITE FOR QUOTE

GUN PARTS CORP. BOX SF0594, W HURLEY, NY 12491  
 914-679-2417 FAX 914-679-5849



# FREE!

## Discount Knife Catalog

- Save up to 50% or more
- Huge selection
- Top quality--no seconds
- Fast service
- Satisfaction guaranteed!

**Cutlery Shoppe**

5461 Kendall Street Dept. SF  
 Boise, Idaho 83706-1248  
 Phone: 1-208-376-0430  
 Fax: 1-208-376-7608

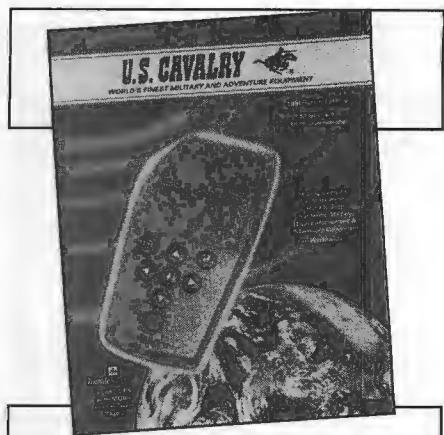

## Target to Adventure!

U.S. Cavalry has everything you'll need for your adventurous lifestyle! Over 100 full-color pages loaded with shooting accessories, knives, hi-tech optics, camping and survival gear, GPS's, official and tactical uniforms, communication equipment, flashlights, boots, military memorabilia, personal protection devices, target practice aids and much more. **Guaranteed 100% satisfaction!** For your catalog, send your name, address and \$3.00 to:

# U.S. CAVALRY



Dept. SF 2855 Centennial Ave.  
 Radcliff, KY 40160-9000

# PRIVACY ?

## Avoid BIG BROTHER.

### Best techniques for creating COMPLETE PRIVACY!

- Avoid Surveillance, Eavesdropping
- Become "Invisible" to Investigators
- Stop Generating Financial Records
- Communications Privacy . . Phone, Mail
- How to Stay Out of Government Files
- Begin Eliminating Negative Records
- How to Create Helpful New Records
- Generating Quick Cash Income
- Hiding Your Assets ■ Privacy Aloft
- Banking Alternatives ■ "Low Profile"
- Privacy from Taxes ■ Nomadic Living
- Multiple Addresses
- Hideouts, Deep Cover
- How to "Disappear"

**ALL THE PRIVACY YOU WANT — and MORE!**  
 Visa/MC: 800-338-8484

**ONLY \$18.95**



EDEN PRESS  
 11623 Slater "C", Box 8410-AP Fountain Valley, CA 92728

Your Choice  Regular P&H, \$3.00 (Please add)  
 **FIRST CLASS, \$6.00 to order.**  
 (California residents please add 7.75% sales tax.)  
 Send latest Book Catalog — FREE.

Name \_\_\_\_\_  
 Address \_\_\_\_\_  
 City \_\_\_\_\_  
 State \_\_\_\_\_ Zip \_\_\_\_\_

## Brand - New Military NIGHT VISION

FROM ONLY \$450.00!

*Great for hunting, boating, fishing, security, search & rescue and survival or just plain fun.*

- Military starlight technology
- Originally manufactured for the Russian KGB
- Full One-Year Warranty
- Immediate delivery available
- Compare our Low Prices!
- Call for a free full-line catalog
- Major credit cards accepted
- 30-day money back guarantee



**BN-453 Starlight**  
 (3.2x Magnification)  
 Only \$545.00!



**RN-M01 Starlight**  
 (2.6x Magnification)  
 Only \$795.00!

**Plus \$12.00 S&H. Californians add 7.75% sales tax**  
**Order Now: 1-800-424-8222**  
 or fax orders to: (714) 497-1270

**M · O · R · O INTERNATIONAL**  
 219 BROADWAY, SUITE 307 LAGUNA BEACH, CA 92651

*We offer the largest selection of BDU's of anyone!*

**100% Cotton Rip Stop: Navy Blue, Black, Grey, Olive Drab, Tiger Stripe, White, Woodland Camo — \$29.95 ea. 50/50 Fabric: Urban Camo (with white), Subdued Urban Camo (No White), Black, Navy Blue, 6-Color Desert, and 3-Color Desert \$29.95 ea. (Woodland Camo \$26.95 ea.) Brown Realtree with lead \$34.95 ea. Blaze Orange \$33.95 ea XXL add \$4.00; XXXL add \$6.00**

- Anorack/Pullover Parka: Woodland Camo, Tiger Stripe, Black, Navy Khaki, Off-White, Olive Green, Trebark, 6-Color Desert and 3-Color Desert ..... \$39.95 (Brown Realtree with Leaf Camo) ..... \$46.95
- Olive Drab Jungle Fatigues Cot. Rip Stop (Slant Pocket) ..... \$29.95
- Two Pocket Tuck-In BDU Shirt (Black, Woodland Camo, Navy, Khaki) ..... \$29.95
- Hi-Tec Super Magnum Boots (Black) ..... \$73.95
- Hi-Tec All Leather Super Magnum Boots (Black) ..... \$78.95
- Desert Storm Boot (Tan). Official Issue ..... \$49.95
- G.I. Quick Lace Combat Boot ..... \$58.95
- Speedlace Jungle Boot (Black) Official Issue ..... \$59.95
- Traditional Olive Drab Jungle Boot ..... \$56.95
- Commercial Jungle Boot (Black, Olive Green and Woodland Camo) ..... \$29.95
- Large G.I. Field pack with Frame ..... \$116.90
- Military Shorts — Seals, Army, Navy, AF, U.S.M.C. .... \$15.95
- Gerber Stainless Multiplier Tool ..... \$58.95 (Black) ..... \$63.95

Mail proper amount plus \$4.95 (double for Canada) (TN residents add 8.25% sales tax) for shipping & handling to:

**GREENE MILITARY DISTRIBUTORS, INC.,**







7215 Kingston Pike, Dept., SF, Knoxville, TN 37919  
 • ORDER TOLL FREE 1-800-521-7977 in TN (615) 588-5945 Satisfaction Guaranteed or Your Money Back

... "The right of the people to keep and bear arms shall not be infringed."

Do it for your country...*The Bill of Rights*  
**BURY A:**

## Patriot Safe <sup>TM</sup>

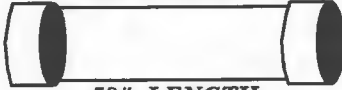
"Underground Burial System"  
**SALE!! \$65.00**  
Reg. \$ 89.95



58" LENGTH

8" Diameter

- \* Air and water tight
- \* Tactical black
- \* Heavy PVC construction with quality materials.
- \* Includes desiccant for added moisture protection
- \* Complete instructions **Do it NOW!!**
- \* **MADE in the USA**

We Accept MC, VISA, COD's or M.O's  
Add 12.00 for S&H 18.00 for AK or HI

## OUTBACK MERCANTILE

PO BOX 33614  
NORTHGLENN, CO 80233  
TEL(303)279-2571 FAX(303)278-7098

## AK SPARE PARTS

AND OTHER NEAT STUFF!



**CATALOG \$2.00**

Global Sales  
P.O. Bx 1000-F  
Delta, UT 84624  
(801)864-4402

### NOTICE TO SUBSCRIBERS:

From time to time, we make our list of customers' names and addresses available to carefully screened companies to send announcements of their products or services.

If you prefer not to receive such mailings, and want your name on our subscriber list only, please write us, enclosing your mailing label.

Please address your request to:

**SOLDIER OF FORTUNE**  
P.O. Box 348  
Mt. Morris, IL 61054  
Attn: Customer Service

## Be a DETECTIVE

**SPECIAL SOF PRICES!** AND EARN YOUR BADGE  
NO EXPERIENCE NEEDED



EST. 1973

**MEN — WOMEN**  
TRAIN AT HOME FOR AN EXCITING PART OR FULL-TIME CAREER AS A PRIVATE DETECTIVE. START YOUR OWN AGENCY OR WORK FOR OTHERS. LEARN ALL THE LATEST TECHNIQUES FROM THE EXPERTS.



WILL MAKE YOU

A

**PRIVATE DETECTIVE.**



"Now earning \$100,000 a year as a P.I. Thank you Global!"  
A.R. Texas

CALL NOW

**617-721-4292**

NO OBLIGATION • NO SALESMAN

**GLOBAL SCHOOL OF INVESTIGATION**  
171 S. PARK ST. STONEHAM, MA 02180

NAME \_\_\_\_\_

ADDRESS \_\_\_\_\_

CITY \_\_\_\_\_ STATE \_\_\_\_\_ ZIP \_\_\_\_\_

FREE INFORMATION

## HANDGUN CONTROL

Continued from page 33

the next few years. A continued PR campaign with the general public as well as the legal and judicial community, will enable us to finally get ground-breaking rulings which can change the violent face of the American landscape for years to come.

**Legal Point 1:** Making possible the suing of owners of guns, as a group, for monetary compensation for victims of gun violence:

Once gun owners in America have been identified through a verifiable source, i.e., the pending national computer registry, it would be possible to seek further compensation for victims of gun violence through legal means. As a group, gun nuts would constitute an identifiable entity for class-action suits and other legal actions for compensation to victims of gun violence.

**Legal Point 2:** Suing gun organizations under the RICO [Racketeer Influenced, Corrupt Organization] statute:

It would be expected that gun groups and lobbying groups such as the NRA would encourage non-compliance. Thus nationally recognized groups will be technically "organizing to break the law." Once this can be proven, these groups will be vulnerable to lawsuits based on the RICO statute and drained of their financial resources through repeated legal action.

**Legal Point 3:** Suing the makers of toy-replica guns, toy weapons and violent entertainment:

One of the purveyors of violence to society, companies which profit from violence would eventually be identified and made legally responsible for the violent acts inspired by their products. A study would have to be created to link these companies to those actions taken as a result of their products. Threat of legal action would convince many manufacturers and distributors that other nonviolence-related toys would be more worthwhile. Lawsuits against makers of violent entertainment and violence-related recreational materials and toys, would make them fiscally accountable for the cost to society in-

curred as a result of their merchandise. Items could include: violent video games, television shows, movies, videotapes, water guns, super soakers, electronic noise guns, replica guns, toy weapons like swords, batons, martial arts items.

Tort law as we know it may not have to undergo a change in order to facilitate these actions. As many people know, it is not necessary to actually win in order to affect change, since the constant threat of legal action will induce change in the way people do business. People all know that the real fiscal effect of repeated legal actions can bankrupt a peddler of violence just as well as winning a large settlement. ✕

## SF IN WACO

Continued from page 35

wise a training team already commanded by a captain.

Communications training began 25 February, while Handy, Dooney and Ackley built the door mock-up, and a

replica of Mount Carmel's front fence. A training schedule for the next day was developed, including live-firing.

Safety considerations forced the Green Beret trainers to get permission from Fort Hood Range Control for the ATF to train with flash-bang grenades.

Agents Buford and King put their forced entry teams through the mock-up several times on the 27th, at least once with two Green Berets acting as Davidians. Although the Army now denies it, sources tell *SOF* training included room-clearing, fire-and-maneuver and building takedown — subjects forbidden by SF policy for instruction to civilian lawmen, according to copies of the policy obtained by *SOF*.

No knock-and-announce entries were rehearsed, nor was a peaceful entry. Other SF trainers worked with ATF agents on the range, where AR-15s, MP-5 SMGs and the ATF's M24 sniper rifles were fired. Sniper rifles were zeroed for 260 meters, the approximate distance from the ATF's undercover house to Mount Carmel.

Agent King would later give testimony about that training, which was misleading — at best. King said under oath that Green Berets were “not involved in the rehearsals” for the raid, that the commandos merely stood by as “observers ... They offered some advice. One was a captain and there were a couple of enlisted personnel.”

Agent Buford acknowledged in testimony that “a detachment from one of the Special Forces units” assisted in ATF's Fort Hood training. “They were there to assist us primarily to make sure our communications system worked.”

Radio communications for the paramilitary-style operation broke down almost immediately, according to a Treasury Department investigative report and testimony from ATF agent Roland Ballesteros, assigned as first agent through the door.

Asked specifically what limits military participation in civilian law enforcement operations, Buford testified “I'm not sure where that line is drawn. I took what they had to offer and utilized it ... They mentioned the fact that they'd like to accompany us, but said they couldn't ...”

According to military sources interviewed by *SOF*, much of the out-

of-bounds training by Green Berets occurred after normal hours, in the barracks. This included Close-Quarter-Battle (CQB) and MOUT topics.

“Individually, they were pretty good at CQB,” said one troop familiar with the operation. “But as a 10-man team goes, they didn't click as well. And when you got three 10-man teams going at once, it was a real problem ... One thing we stressed and stressed was not to try an operation like they were planning during daylight hours. It would be suicide ... All of our guys were pissed off at having to be there under those circumstances.”

On 27 February, ATF agents left for their staging area near Waco. The Special Forces MTT cleaned up their gear and prepared to depart.

Or, *most* of them did.

Flight logs for two helicopters picking up the MTT at Fort Hood confirm four Green Berets did not depart with the rest. Two UH-60 Blackhawks assigned to the 160th Special Operation Aviation Regiment in Fort Stewart, Georgia — part of the secretive Task Force 160 — picked up six Green Berets and a load of gear at 2000 27 February at the MOUT facility. They flew to McGregor Range. Logs indicate the Blackhawks arrived before midnight, being temporarily grounded en route by rain.

Dunn, Wilson, Ackley and Moreland remained behind, *SOF* sources say, to observe the next morning's ATF raid. What they saw upset and scared them.

The Army strongly disputes their presence at Mount Carmel: “There were no Special Forces personnel present when the ATF conducted their raid on the Branch Davidian compound,” said Lieutenant Colonel Ken McGraw, a spokesman for the Army Special Operations Command at Fort Bragg. McGraw referred further questions to the U.S. Special Operations Command in Florida.

An Army spokesman in Florida, Lt. Col. Chuck Merlo, confirmed a Green Beret training detachment from Fort Bragg provided assistance to ATF in the days before the raid, but emphasized “none of our people were at the raid.”

“What we did do was set up some ranges at Fort Hood,” near Waco, and “assisted them in setting up and sight-

ing in their weapons, and provided some medical training,” Merlo said.

The Army refused to grant interviews with any members of the MTT. The ATF has also declined comment. But troops — and many people in ATF — remain outraged by what happened.

“Some of the ATF agents at Fort Hood, especially some of the older agents, privately questioned the wisdom of this whole goat-chain,” one Army source said. “Not only did they think the raid was unnecessary, but they felt the legality of that raid was vague, at best, especially after what happened at Fort Hood.

“Waco is the crowning fiasco of what a big lie JTF-6 is,” he said. “If one follows the philosophical premise of Operation Alliance and JTF-6 to a logical conclusion, Special Forces is being groomed to accept, unquestioned, a role in internal security operations against citizens of this country.”

“Are we worried about being found out?” asked another. “Of course we're worried. First there'll be denial. Then there'll be a search for the guilty parties. That's already started. The Army engaged in a cover-up on this from the moment the news hit the fan about that [ATF] raid. We have been ready to be subpoenaed since this happened. We've been prepared for it. We've been expecting it.” ✕

---

## WACO TRIAL

*Continued from page 43*

woman in the jury box began to cry.

*Watch for Part Two of SOF's detailed coverage of the Branch Davidian trial, including the verdict and what it means, in next month's issue. Part Two includes confirmation of friendly fire casualties among the ATF raiding party and testimony from the government's own witnesses that indicates gunfire from helicopters, and more evidence that ATF fired the first shots. Plus verbatim dialogue from the 911 call and FBI eavesdropping devices.*

Jim Pate covered the Mount Carmel standoff and subsequent inferno for *SOF* last year, and was present for the entire trial. ✕

# CLASSIFIEDS

**CURRENT REQUIREMENTS** — 2.00 per word per insertion — \$40.00 minimum. All ads **MUST BE PREPAID**. Ad copy must be typed or written clearly with authorizing signature, a telephone number (for our files) and full payment. Advertisers offering information packets for a fee must send sample of packet (packets will not be returned). Name, address and telephone number are to be included in your word count. **EXAMPLE:** P.O. Box 693 = 2 words; 80306 = 1 word. Abbreviations such as DI, SGT, 20mm, U.S. count as one word each. Hyphenated words and telephone numbers are counted as two words. No personal services ads accepted. We reserve the right to refuse, delete or change any copy which we determine to be objectionable. Mail classified ads with payment to **SOLDIER OF FORTUNE, Classified Dept., P.O. Box 693, Boulder, CO 80306.**

## NOTICE TO READERS

**SOLDIER OF FORTUNE Magazine** is a magazine of national and international distribution. There may be products for which sale, possession or interstate transportation may be restricted, prohibited or subject to special licensing requirements in your state. Purchasers should consult the local law enforcement authorities in their area

**READERS OF BOTH DISPLAY AND CLASSIFIED ADVERTISING ARE ADVISED THAT SOLDIER OF FORTUNE MAGAZINE DOES NOT VERIFY VALIDITY OF EVERY ADVERTISEMENT AND/OR THE LEGALITY OF EVERY PRODUCT CONTAINED HEREIN. SHOULD ANY READER HAVE A PROBLEM WITH PRODUCTS OR SERVICES OFFERED BY AN ADVERTISER, HE SHOULD SEEK ASSISTANCE FROM HIS NEAREST POSTAL INSPECTOR AND ALSO CONTACT OUR ADVERTISING DEPARTMENT. SOLDIER OF FORTUNE DOES NOT INTEND FOR ANY PRODUCT OR SERVICE ADVERTISED TO BE USED IN ANY ILLEGAL MANNER.**

**HOMEMADE ROCKET MOTORS**  
Make your own Commercial-Quality rocket propellants as well as simple sugar and fertilizer fuels. Explicit diagrams show you how to make motor casings, nozzles, electric igniters, rocket designs & recovery devices with a complete list of suppliers. Order your book Today and receive FREE Tennis Ball Cannon plans. Send \$15 to:  
**AEROTEK**  
P.O. BOX 57152, MILWAUKEE, WI 53237  
ORDERS SHIPPED IN 48 HOURS  
100% MONEY BACK GUARANTEE

**BETTER TO BE JUDGED BY TWELVE THAN TO BE CARRIED BY SIX**

**100% COTTON, BLACK SCREENED T-SHIRT**  
M, L, XL: \$15.00  
XXL, XXXL: \$20.00  
ADD \$3 P&H FOR FIRST SHIRT, \$1 ADD'L BUMPER STICKERS: \$1.00 EACH  
**VERDAMEN**  
P.O. BOX 20360  
NEW YORK, NY 10009  
NY RESIDENTS ADD 8.25% SALES TAX

## NEW TARGETS

**Make shooting fun!**  
Six military and combat style designs developed to make your shooting more fun.



**Develop a strategy** — Choose your plan of attack. Special scoring zones put you in the action. Standard size: 10 1/2 x 12 in. Works for both handgun and rifle. 36 targets for only \$9.95 plus \$2.00 postage.

★ **SEND CHECK OR MONEY ORDER TODAY** ★

## Now YOU can join

OPEN TO THE PUBLIC AS WELL AS TO PROFESSIONAL INTELLIGENCE MEMBERSHIP.



Receive membership card, newsletters, important reports, special product offers and some very interesting opportunities.

SEND YOUR \$28. CHECK, FOR ONE (1) YEAR'S MEMBERSHIP, MADE OUT TO OUR PROCESSING AGENT:  
**AMERICAN COMMUNICATION ARTS (DEPT. SFC-1)**  
1742 GARNET AVENUE - #144  
SAN DIEGO, CA 92109

### Telephone Listening & Recording Devices

**MA-100** Devices Hidden In Dual Modular Adapters!  
FM Transmitter  
Crystal clear reception on FM radio up to 1/4 mile  
SnapKif uses phone line for power & antenna

**DMR-20** Recording Adapter  
Starts & stops recorder when phone is used.  
Plugs into standard cassette recorder  
Works when any phone in house is used

\$25.95 free shipping Visa/MC (214) 255-7490  
Seymour-Radix Inc. Box 166055 - SF Irving, TX 75016

★ **MONEY BACK GUARANTEE** ★

**RATTLER RIDGE** 236 West Portal Ave. #324-B  
San Francisco, CA 94127

Name \_\_\_\_\_  
Address \_\_\_\_\_  
City \_\_\_\_\_ State \_\_\_\_\_ Zip \_\_\_\_\_

Prices **RK Enterprise** Check  
Include **P.O. Box 420482** M.O.  
S & H **Atlanta, GA 30342** C.O.D.  
**(404) 843-3114**

**GAS MASKS \$22.50**  
*W. German with Nato Filter*

**AK-47 30RND. MAGS. \$11.50**  
*E. German & Chinese*

**130,000 VOLT \$34.95**  
**STUN GUNS**

**BEAUTIFUL ORIENTAL LADIES**  
PENPALS, ROMANCE, MARRIAGE!  
Videos available! Details, color photos — \$1 to:  
P.I.C., P.O. Box 461873-SF, Los Angeles, CA 90046



**BEATING RETREAT (60 Minutes)**  
**VHS ONLY \$39.95**  
By the massed bands of the Royal Marines. A spectacular rousing performance.

**BRITISH REGALIA IMPORTS**  
Department 6  
P.O. Box 50473, Nashville, TN 37205

HAT PINS · PATCHES · FLAGS

**1500+ MILITARY DESIGNS**  
FREE 24 Page ILLUS. CATALOG  
WE DO CUSTOM WORK  
Dealer Inquiries Welcome

**HOOVER'S MFG. CO.**  
40155F PROGRESS BLVD.  
PERU, IL 61354  
(815) 223-1159, Ask For David

## APPAREL

**VIETNAM TIGERSTRIPES**, Thai/Vietnam Pattern worn by Special Forces & S.E.A.L.'s; NEW \$72.00 Suit; Matching Boonie Hat \$16.00. A.H.A., Box 21606, Denver, CO 80221. (199)

**FRENCH FOREIGN LEGION TEE SHIRT** with Legion Motto in French and Latin! \$10.00 each! WOLFGANG, Box 709H, Prudenville, MI 48651. (200)

## PHOTO ID CARDS

- Drivers Licenses
- Law Enf. Certificates
- Social Security Cards
- College Degrees
- Birth Certificates
- Military Certificates
- High School Diplomas
- Trade School Diplomas

**Free Information**  
Miller Publishing Co., Dept.SOF  
7850 White Ln. Ste. E330 BKFD. CA 93309

**MILITARY UNIFORMS FROM 50 NATIONS!** Newly Updated Catalog of Rare & Unique Military Camouflage Uniforms from around the World. \$1.00. A.H.A., P.O.Box 21606, Denver, CO 80221. (199)

**FOREIGN CAMOUFLAGE!** Austria, Germany, Swiss, Britain, France, Russia, WWII, Snow, plus more! Send \$1.00 for catalog. WWM, 13017 Wisteria Drive #331SOF, Germanstown, MD 20874. (199)

**CAMOUFLAGE AND MILITARIA** from over 50 countries. Send \$1.00 for New Spring Catalog. WORLD MILITARIA, P.O.Box 6022, Arlington, TX 76005. (199)

**"PHUQUE U."** T-Shirts. White. Blue lettering. 50% cotton. \$14.95 each. Three for \$30.00. Any size. FINEARTS, Box 3491, Knoxville, TN 37927. (199)

## AUTOMOTIVE

**CARS FOR \$200?** Trucks, boats, 4wheeler, motorhomes, furniture, electronics, computers, etc., by FBI, IRS, DEA. Available your area now. Call 1-800-436-4363 Ext. C-8258. (199)

## BOOKS & PUBLICATIONS

**MEN OF ACTION AND ADVENTURE** - Paladin Press has been described as "the most dangerous press in America." Millions of satisfied readers disagree. Outrageous and controversial books and videos on firearms, exotic weaponry, new identity, creative revenge, espionage and investigation, privacy, action careers, and more! To order our 56-page catalog send \$2.00 to: **PALADIN PRESS**, Box 1307-4AQK, Boulder, CO 80306, (303) 443-7250 (200)

**OFFICIAL SOF LOGO MAGAZINE BINDER.** Holds 12 issues. \$12.00 plus \$4.00 P&H. VISA/MC accepted. No COD's. **SOF BINDER**, P.O.Box 693, Boulder, CO 80306. (200)

**THE ANARCHIST COOKBOOK** is now available again! Complete, uncensored edition. Send \$25 to: **BARRICADE BOOKS**, PO Box 1401-Z, Secaucus, NJ 07096. (206)

**BOOKS ON AFRICAN WARS**, hunting, politics. Catalogue \$2 write: Lemur Books, P O Box 1645, Alberton, 1450, SOUTH AFRICA: Fax 011-869-0890 (205)

### BE A HOME INSPECTOR!

Train at home. Start a profitable business. Free literature: 800-223-4542.

Name \_\_\_\_\_ Age \_\_\_\_\_  
 Address \_\_\_\_\_  
 City \_\_\_\_\_ State \_\_\_\_\_ Zip \_\_\_\_\_  
 School of Home Inspection, Dept. PF171  
 6065 Roswell Road, Atlanta, Georgia 30328



### BE A PROFESSIONAL SKIPTRACER & MISSING PERSON INVESTIGATOR!

AMERICA'S FASTEST GROWING INVESTIGATION INDUSTRY! LEARN SKIPTRACING & MISSING PERSON INVESTIGATIONS. ATC'S IS THE NUMBER ONE PROFESSIONAL TRAINING PROGRAM: PROFESSIONAL TECHNIQUE TO TRACKDOWN FUGITIVES, SKIPPERS & MISSING PERSONS. THIS EXCLUSIVE PROGRAM HAS BEEN DESCRIBED BY PROFESSIONAL BOUNTY HUNTERS AS THE "1-2-3 HIDEOUT BUSTER". OVER 550 PAGES (7 PROF. BOOKS). INCLUDES COMPLETE US & CANADA SEARCH REFERENCES (800 PRIVATE & PUBLIC INFO. SOURCES). CHARTS, CHECKLISTS, ONLINE DATABASES. THE BEST TRAINING PROGRAM ALL AROUND!

DZ'S OF EXCLUSIVE INVESTIGATION FEATURES. STUDY TODAY, START TOMORROW! \$50-\$100,000 YEAR!!! START WITH MINIMAL INVESTMENT. PROGRAM COMES WITH "FASTRACK GUIDE TO SUCCESSFUL SKIPTRACING" FORMSETS AND MORE!!! TREMENDOUS OPPORTUNITIES TODAY "IN THIS FIELD OF THE FUTURE"!!!

SEND \$2.00 FOR 16 PAGES INFOPACK!

### ATC: PROFESSIONAL TRAINING IN TRACKING DOWN FUGITIVES!

**American Tracing Corp.**  
 289 College Street, Burlington, VT 05401-8320

### REGIMENTAL INSIGNIA & WEAPONRY

- SAS • RAF • BLACK WATCH
- PARA • AM • CAMERONS
- ASDG • AN • GUARDS etc.

Import Catalog \$6.00  
**BRITISH REGALIA IMPORTS**  
 Department-6  
 P.O. Box 50473 • Nashville, TN 37205

### WORLD'S FINEST SPY EQUIPMENT

#### LOWEST PRICES "NO JUNK"

Real smoke "BUG DETECTOR" totally covert! Continually sweeps for bugs and body wires. Ours is the best, adjustable sensitivity, extreme broadband. 10 MHZ — 2 GHz! Easy to install and use. Battery included. **Only \$149.95 + \$6.00 S&H.**

Spaceage RF BUG SWEEPER. Micro-size design to conceal in real cigarette pack. Very hightech! Adjustable sensitivity and bargraph display locates transmitters fast! Broadband 10 MHZ — 2 GHz! Battery included. **Only \$149.95 + \$6.00 S&H.**

Lowest prices anywhere!! Factory direct catalog from former intelligence agent!! Send \$5.00 to:  
**OPERATIVE SUPPLY 3111 ARENDELL ST. MOREHEAD CITY, N.C. 28557**

ENCYCLOPEDIA OF REVENGE — NOW IN SOFT COVER — The Most Devastating Manual Ever Published! Over 1000 Entries. Completely Cross-Referenced. It would take 15 books to Equal the Information Jam-Packed in this Giant 8 1/2 x 11 Volume. \$19.95 plus \$3.50 Shipping/Handling to: ANCHOR PUBLISHING, P.O. Box 2630-S, Landover Hills, MD 20784. Visa/Mastercard orders call 24 hours, (800) 448-6280. Dealer Inquiries Invited. (199)

UNDERGROUND SOURCEBOOK OF RARE DEVICES products and knowledge. The Underground arsenal has surfaced! Write (free info): Box 365-U5, Penfield, NY 14526-0365. (198)

WHO KILLED KENNEDY? Assassination research materials: Videocassettes, photographs, books, unpublished manuscripts. Catalogue: \$3.00. COLLECTOR'S ARCHIVES, Box 2, Beaconsfield, Quebec, H9W 5T6 CANADA. (204)

GAMBLING'S GREATEST WINNING SECRET revealed! Win consistently with flat bets. Scientific proof provided. Free report. PROSPER PUBLISHING, Box 7521-U, Dallas, TX 75209. (199)

### SAM ANDY FOODS

**FREE** SAM ANDY SURVIVAL TIMES NEWSLETTER & CATALOG

BE A SAM ANDY FOODS DEALER IN AN UNLIMITED TERRITORY IN YOUR SPARE TIME. OUR FOOD RESERVE SYSTEMS ARE THE FASTEST GROWING MONEY-MAKING PRODUCT LINES DEVELOPED IN THE DECADE.

"TWO NEW VIDEOS"  
 "THE MOST IMPORTANT INSURANCE FOR THE 90'S" GENERATES SALES FOR YOU. INSTANT CREDIBILITY.  
 "THE SAM ANDY OPPORTUNITY OF THE 90'S" TAKES YOU ON A TOUR OF OUR FACILITIES AND DEMONSTRATES THIS NEW MONEY-MAKING MARKET.

**ONLY \$29.00. SAVE! BOTH FOR \$49**

**WRITE OR CALL TOLL-FREE 1-800-331-0358**

DEPT. JB1 P.O. BOX 141741, IRVING, TX 75014  
 FAX: 214-869-2087 DEPT. JB1

**RECESSION PROOF BUSINESS**

### Las Vegas Showgirl Videos

**FREE!** BARGAIN VIDEO CATALOG with 3 FREE VIDEOS

Introductory Special Bonus Offer For All New Customers. Enclose \$3 shipping

10 VIDEOS \$10  
 20 VIDEOS \$20

VIDEO LIQUIDATORS Dept 5054  
 Box 85311, Hollywood, CA 90072

### MILITARY VEHICLES

**SUBSCRIBE TO THE MAGAZINE THAT MORE THAN 10,000 READERS TURN TO FOR ARTICLES, ADS & NEWS ABOUT MILITARY JEEPS, TRUCKS, TANKS & MORE!**

Full listing of upcoming rallies.

**MILITARY VEHICLES**  
 MAGAZINE

USA: 1 Year (6 Issues) \$15 • 2 Years (12 Issues) \$25  
 Canada: 1 Year \$24 • 2 Years \$44. All Others: 1 Year \$26 • 2 Years \$46

P.O. Box 1748-L • Union, NJ 07083

**THE MARKETPLACE FOR MILITARY VEHICLES**

THE POOR MAN'S JAMES BOND \$22. The Outlaw's Bible \$15. The Anarchist Cookbook \$25. Exotic Weapons \$15. Armed Defense \$15. Privacy \$18. Underground Book Catalog \$3. Visa/MC 916-725-0341. Checks and Money Orders Accepted. FS BOOK CO., P.O. Box 417457 Dept 5F, Sacramento, CA 95841-7457. (199)

GET THIS INFORMATION BEFORE GOVERNMENT Legislation Bans It! The International Encyclopedia of Improvised Munitions now available by sending \$25.00 check or money order to MORGAN ENTERPRISES, P.O. Box 83364, OKC, OK 73148. (199)

TOO MUCH BS SINCE ETS? Sound off! Your voice can be heard. "COMRADERY." New newsletter provides comms between vets worldwide. 6 months, \$25. KWPE, 2602 S. Husband, Stillwater, OK 74074. (199)

ANGRY WITH U.S. GOVERNMENT? Publisher seeks manuscripts exposing corruption, coverups, incompetence. Write for details, MAGIC BULLET, 1600 South Dixie, Suite 1A-622, Boca Raton, FL 33432. (200)

SIMPLIFIED CHEMISTRY FOR EXPLOSIVES. Simple methods for making C-4, TNT, more. Send \$9.95: ChemEX Development, Box 945, Gadsden, AL 35902. (204)

### BUSINESS OPPORTUNITIES

VOICEMAIL SYSTEMS for IBM-PC's from \$295. Useful for blind mailboxes, outboard dialers, Int'l callback, telephone conversion bugs or profit making ventures. Anytime 800-283-4759 or Demo 818-718-9560. (199)

LET THE GOVERNMENT FINANCE your new or existing small business. Grants/Loans to \$500,000. Free recorded message: (707) 449-8600. (KW5) (202)

### COLLECTORS

MILITARY COLLECTIBLES: WWII/WWIII/Korea/Vietnam. CURRENT: Patches/Badges/Rank Insignia/etc. Catalog \$3.00. CALL (408) 295-1136 or write: LEE-JACKSON MILITARIA, P.O. Box 8663, San Jose, CA 95155-8663. (200)

### NUDISM LIFESTYLE: FAMILY RECREATION

Publications • Videos

\$3 for details:  
 LIFESTYLES-SF  
 Box 661268, Los Angeles, CA 90066

### YOUR MILITARY MEDALS!



**LARGEST INVENTORY IN THE U.S.A.!**

- FULL SIZE US MEDALS • SKILL BADGES
- UN AND RVN MEDALS • DISPLAY CASES
- MINIATURE MEDALS • MANUALS ON
- OFFICIAL RIBBONS • CLAIMING MEDALS
- RANK BADGES • PATCHES... ALL GUARANTEED!

SEND \$2.00 TODAY FOR ALL NEW COLOR CATALOG!

**MEDALS OF AMERICA**  
 1929S2 FAIRVIEW ROAD  
 FOUNTAIN INN, S.C. 29644

### UNUSUAL BOOKS

MANY AVAILABLE NOWHERE ELSE  
 100's of Titles to Choose!

CREDIT • EMPLOYMENT • EXOTIC WEAPONRY • MARTIAL ARTS • PRIVACY • NEW IDENTITY • DISGUISES • SURVEILLANCE • FIREWORKS and Much, Much More!  
 Best Prices and Selection. Money Back Guarantee.  
 Catalog . . . . \$1.00

**ALPHA PUBLICATIONS**  
 PO Box 308-M Sharon Center, OH 44274

VIETNAM WAR INSIGNIA AND UNIFORM LIST. I mail a list of Vietnam War Militaria six times per year. Buyers receive a list free, others pay \$3 per list. Insignia are pictured so you know what you are buying. I always have a nice collection of original patches, insignia, books, maps, uniforms, field gear etc. Both U.S. and VC/NVA. I also buy singles and collections of Vietnam War souvenirs. 100% guarantee from me. Buy with confidence. Write or call. I always enjoy getting the straight skinny from the troops in the field. BILL BROOKS, P.O. Box 230832, Montgomery, AL 36123. (205) 244-1916. (205)

BRITISH/SCOTTISH MILITARIA COLLECTORS. Regimental insignia and accessories of elite Regiments; including SAS; Paratroopers; Royal Marines; Black Watch; Guards, etc. Import Catalog \$6.00. BRITISH REGALIA IMPORTS, Department 6, P.O. Box 50473, Nashville, TN 37205. (199)

UNITED NATIONS INSPECTOR'S CAP. Blue Baseball Cap with U.N. Patch \$20.00. UNITED NATIONS BERETS, Sky Blue Beret with Enamelled U.N. Badge Unissued \$30.00. UNITED NATIONS Patch \$5.00. A.H.A., Box 21606, Denver, CO 80221. (199).

WWII RELICS! Cheaper than certain "well-known" relics dealers! We beat their prices for flags, daggers, medals, helmets. Catalog, \$5 (refundable). Telephone: (612) 689-1146. MILITARIA, Box 261-D, Cambridge, MN 55008. (200)

RHODESIAN AND SOUTH AFRICAN BADGES. Medals and uniforms for sale. For a list send \$1 to KAPLANS, Box 890638, Lyndhurst 2106 South Africa. (201)

NOVELTY MILITARY ITEMS. Pins, patches, flags, unit bumper/window stickers, and more. COLOR BROCHURE \$2.00 each. D&G, P.O. Box 180, Salem, AL 36874. (199)

SELLING 5 ORIGINAL NAZI BOOKS, one rare and all published in Germany between 1934 and 1941. More information: POECKH, P.O. Box 8081, Lacey, WA 98503-0488. (199)

### EDUCATION

TERMPAPER ASSISTANCE. 19,278 topics available! 306-page catalog—rush \$2.00. Research, 11322 Idaho, #206EX, Los Angeles, CA 90025. TOLL-FREE HOTLINE: 800-351-0222 (California: 310-477-8226). (200)

### EMPLOYMENT

ALASKA OPPORTUNITIES HANDBOOK. Live, work & play in the "Last Frontier". \$10 booklet. Box 3025C, 2900 Boniface, Anchorage, AK 99504. (199)

OVERSEAS, STATESIDE. \$100-\$1,000 daily. Now hiring. FREE list. ZINCS 117, Box 585, Dearborn, MI 48120 (202)

Men & Women! Be A...  
**PRIVATE EYE**



Amazing one-of-a-kind home study course tells all! Want a life of intrigue, excitement, adventure?! Quickly learn from the experts:

- How To Earn \$100,000 A Year As Your Own Boss!
- How To Conduct All Types Of Private Investigations, Skiptracing & Surveillance!
- How To Start Your Own Private Detective Agency!
- How To Work From Home, Part-Time or FullTime!
- No Experience Necessary, No Investment Required!

**STATE APPROVED**

Located in the Entertainment Capitol Of the World! **(213) 879-1165**

FREE DETAILS

UNITED STATES ACADEMY OF PRIVATE INVESTIGATION  
P.O. BOX 2133 (SF)  
BEVERLY HILLS, CA 90213

**SKELETON KEY**

FITS MOST LOCKS

(bollocks, doorlocks, & some padlocks)

Amaze Your Friends

With A Lock Picking Demonstration.

You get 3 sized metal tension keys, the slide pick, precise instructions & more. Note: this device is to be used for demonstration purposes only! Satisfaction Guaranteed or Full Refund; 2 weeks delivery.

To get this exciting device. Send Now ONLY \$8.95 + \$2 S&H to: Safe Marketing \* 90 W. Montgomery Av No.366SF \* Rockville Md 20850

**WORK IN PARADISE:** Secrets of Overseas Employment. Tax Free Income. FREE info: IES, 15327 Sunset Blvd. #106, Pacific Palisades, CA 90272. (202)

**ALASKA—WORK WHERE YOU WANT TO PLAY—**Job Opportunities Booklet-\$10. Box 3025C, 2900 Boniface, Anchorage, AK 99504. (199)

**FEDERAL LAW ENFORCEMENT** Employment Guide. 37 page booklet detailing 33 Federal Agent/Officer Careers, job descriptions, qualifications, application procedures, salaries and more. Send \$9.95 to FCF EMPLOYMENT GUIDE. P.O.Box 2176, Brunswick, GA 31525-2176. (199)

**INTERESTING CAREER LISTINGS:** Police, security, investigation. Nationwide, some international. Executives to \$119,300. Positions explained. Four monthly issues. \$21.95. PSIC/F.O, P.O.Box 3831, Springfield, IL 62708. (199).

**FIREARMS - ACCESSORIES**

**NATIONAL MILITIA NEEDS YOU!** United States Special Force: Government chartered, needs leaders as volunteer officers in home town. Courageous, self-reliant 18 or older. \$5 brings information and application for commission. Write: GENERAL, Box 432, Camp Bradley, FL 32066 (200)

**\*\*\*MACHINE GUNS\*\*\***All models available, new and used. \$275-\$3500. (No Conversion Gimmicks!) All legal forms and applications! 1-800-759-5942. 24hrs. (199)

**FOR SALE**

**HUNTING RETREAT,** 34 room fully equipped, semi-isolated northern forest, Alberta, Canada, river, pavement. \$200,000.00. 1-403-927-4470. (199)

**20-40 ACRES-\$5,995 & UP. MONTANA LAND CO.,** Box 5237, Helena, MT 59604. (406)442-7496. (201)

**FREE**

**FREE CATALOG—Military/Education** Diplomas, Certificates, Awards; any High School, University, Government Dept, New European & Corporate coat of arms. COUCH POTATO PUBLISHING, 4211 Little Rd., Suite 9, New Port Richey, FL 34655. USA. (199)

**DRIVER'S LICENSE** (entire USA). Must be U.S. citizen. Free application, information. MAXSELL, Box 23021, Ft. Lauderdale, FL 33307. 305-568-1480 (24 HRS). (199)

**IT'S INCREDIBLE** how easy the original issue lenses are broken. Easily snap out the old lens. Then snap in place our polycarbonate lens, which is not bullet proof, but thicker and much stronger than the original lens. (250 times stronger than glass of the same thickness). Borech resistant and U.V. resistant, super hard polycarbonate anti-shatter, anti-scratch lens allows you to snap in your original issue lens and our lens for brightness control.

**A must for every soldier** (no matter how old) who wants to keep his eyes without any...  
rivers... paintballers, and shooters...  
Use...  
Use...  
Use...

The Sun, Wind and Dust Goggles are issued by the Armed Forces to use under the Kevlar Helmet.

**Z-Thru Products™**



Has formed lenses to fit.  
Call for group and quantity discounts. Dealer inquiries welcome.

8314 Greenwood Ave. Ste. F102, Seattle, WA 98103  
Pre-Paid \$29.00 inclusive shipping & handling.  
\$33.00 includes C.O.D.  
1 (800) 404-8478  
U.S. Funds only.  
cash, check, or money order.

**Russian Ladies, truly beautiful, want to meet you!**

260 Beautiful, Educated Russian Ladies are sincerely seeking friendship and marriage with American men of all ages.

We have selected these ladies from over 4800 applicants.

**FREE Color Photo Brochure**

**RUSSIAN CONNECTION**

Dept. 100 • P.O. Box 888851 • Atlanta, GA 30356

(404) 458-0909 (24 hours)

**EXCITING MOSCOW TOURS AVAILABLE**

**U.S. MILITARY INSIGNIA**  
1940 through Current  
Large Catalog, \$3.00  
**SAUNDERS**  
Box 3133 • SF • Naples, FL 33939-3133

**- COURSES -**

- COMBAT BROCHURE \$3.00 Cash
- RECONDO
- SPL OPS.
- SNIPER

**SPECIAL OPERATIONS GROUP INT.**  
P.O. BOX 94, TRADE, TN 37691 USA

**INSTRUCTION**

**SKS FULL AUTO CONVERSION.** No modification, alteration or deletion of original parts. Simple illustrated instructions \$10. SARDAUKAR, Box 38531-S, Germantown, TN 38138. All BATF Rules Apply. (204)

**FBI/CIA FILES!** Do they have yours? Find out and get copy! Guaranteed. \$4.00. SHESHAR RESOURCES, DSO1, P.O.Box 1170, Evanston, IL 60204. (199)

**KNIVES - BAYONETS**

**RUGGEDLY BUILT NAVY SEAL Diver's/combat knife,** \$44.95 ppd. Money back guarantee. WORKMAN'S, Dept SOF, Box 312, Edinburg, PA 16116. (199)

**COLD STEEL, SPYDERCO, GERBER, SOG and more.** Huge discounts! Free list. KNIVES PLUS, 2435 Interstate 40 West, Amarillo, TX 79109. (800)687-6202. (200)

**EZ-OPEN** Unique American factory made automatic folders. Satisfaction Guaranteed. Send stamped SASE. EZ-OPEN, 2472 Broadway, Suite 305, Dept SOF, New York, NY 10025. (202)

**MISCELLANEOUS**

**ADVENTURE, CAMPING,** finding the action. Use this protective vinyl portfolio containing U.S. road atlas, vacation guide, erasable marking pen for charting trip on clear receptacle. Another receptacle for records. \$10.95. BHG, P.O.Box 498, Dept SOF, Pine Beach, NJ 08741. (199)

**THE ULTIMATE KNIFE AND GUN LEATHER catalog.** \$4.00 refundable with order. Buy it Wholesale! THUNDERBOLT SALES, Box 1222SOF, Andrews, TX 79714. (199)

**"CLINTON BLOWS" T's**  
100% cotton T's (Hanes) • 50/50 sweats • multi-color on gray • "Fire the Laser" on front breast S, M, L, XL • (DOL, 300L add \$2.00)  
Price: T's \$14.99\* X  
Sweats: \$24.99\* X  
postage and handling • 3.50  
MD residents add 5% tax  
Specify T's or Sweats, quantities and sizes  
Send name, address with check or money order to:  
MD Industries, Inc. • P.O. Box 1687 • Ellicott City, MD 21041

**SURVEILLANCE & COUNTERSURVEILLANCE Electronic Devices**  
Bugging/Phone Tapping Detectors • Caller ID • Covert Video • Phone Scramblers • Voice Changers • Shotgun Mics • Vehicle Tracking • Transmitter Kits • Locksmithing • AND MORE!  
7 - Hour Telephone Recording System  
Tapes phone calls automatically. \$125.00  
**FOR CATALOG SEND \$5.00 TO...**  
**EDE**  
P.O. Box 337, Buffalo, NY 14226 (716) 691-3476

**AUTHENTIC SOVIET WATCHES, BINOCULARS, MILITARY CLOCKS**  
★ KGB Restricted-Issue MICRO BINOCULARS. New. Folds to fit secretly in pocket. For sports, concerts, and covert operations. Russian documents. \$49.95  
★ Red Army TANK CLOCKS. New. Limited Supply. Two button timer. Produced in Chelyabinsk. Russian documents. Mounted in lucite base. \$179.  
★ MIG 29 Fulcrum COCKPIT CLOCKS. Real time face & two inset faces (light time & stop watch). Individually numbered. 25-jewel. Internal heating mechanism. New. Mounted. Limited Quantity. \$389.  
★ RUSSIAN POCKET WATCHES. Cold War Era. "Loyal Comrade's Watch." Engraved with Hammer & Sickle. New. \$49.95.  
IMPORTED FROM RUSSIA. FREE SHIPPING. MONEY BACK GUARANTEE. VISA/MC ACCEPTED OR SEND CHECK OR MONEY ORDER TO:  
**HALL INTERNATIONAL**  
SUITE 4201-B, LYONS VIEW PIKE, KNOXVILLE, TN 37919  
(TN RESIDENTS ADD 0.25% SALES TAX.)  
**ORDER NOW: 1-800-960-6009**  
**OR FAX ORDER TO (615) 588-0853**

**BUSHPILOT WINGS**  
BADGE QUALITY — CORROSION FREE RHODIUM  
SEND \$6.95 TO: BUSHPILOT  
P.O. BOX 541384  
DALLAS, TX 75354-1384  
CATALOG WITH PURCHASE — ALLOW 4-6 WEEKS

**BE A PARALEGAL!**  
Attorney-instructed home study prepares you for an exciting future in America's hottest career. Free booklet 800-223-4542.  
Name \_\_\_\_\_ Age \_\_\_\_\_  
Address \_\_\_\_\_  
City \_\_\_\_\_ State \_\_\_\_\_ Zip \_\_\_\_\_  
The School of Paralegal Studies, Dept. LF171  
6065 Roswell Road, Atlanta, Georgia 30328

**"ALL YOU WANT TO KNOW ABOUT** Joining The Navy. That Your Recruiter Never Tells You." Send \$5.00 to NATHAN PYLES, 772 Woodlawn Ave #B, Chula Vista, CA 91910. (199)

**50,000 MAPS. TOPOGRAPHIC.** Tactical quadrants, travel, pallical (Vietnam, Shithatha, Ohio, ANYPLACE!). Catalog \$3.00 (refundable). MONARCH, P.O.Box 42003-203F, Phoenix, AZ 85080. (1-602-530-8687 "Beck"). (199)

**VANISH FROM POLICE RADAR!** Stealth/VRCed legal jammer reliably defeats police radar. \$595. License plate lens beats Photo Radar. \$89.95. JANNERS, INC. 800-451-4477. (199)

**NEW IDENTITY!** Everything included to completely change identity. Driver's license, Social Security, Birth Certificate, Identification Card, Complete Instruction Booklet. Send \$29.95 to "CAS", P.O.Box 2392, Redondo Beach, CA 90278. (199)

**BENEVOLENT KNIGHTS OF THE MILITARY** Order of the Tower (Military Knights of Charity). Free Information. THE GRANDMASTER, Chancery Office, 3310 Tyrone, El Paso, TX 79925. (199)



**ARREST Violators!**



**Wear the Badge of a DETECTIVE**

**NO PREVIOUS TRAINING NEEDED**

Your spirit of adventure, danger, and self reliance can lead you to an exciting career opportunity. Solve mysteries, bring criminals to justice, protect the innocent. Experts guide you every step of the way. Men and women needed to work in challenging situations, withstanding hardships, make on the spot decisions.

Learn the latest investigative techniques using special law enforcement equipment . . . the same equipment used by the FBI, the CIA, and the Secret Service. Start your own investigative agency. Save up to 25% and more on all equipment. Send for free details.

Approved by Calif. Dept. of Public Instruct.  
**THE ROUSE SCHOOL of Special Detective Training**  
 Dept. SG405 P.O. Box 25750, Santa Ana CA 92799

Name \_\_\_\_\_ Age \_\_\_\_\_  
 Address \_\_\_\_\_  
 City/State/Zip \_\_\_\_\_

**CHOOSE FROM HUNDREDS OF FASCINATING WOMEN**

**FANTASY ISLANDS**, America's only guidebook on meeting exotic women and international travel, is for the adventurer in search of romance or the man who wants to find a wife from a distant land. Free information package! Write or call:  
 World Community Publishing  
 734 Haight, Suite D(13), Alameda, CA 94501  
 510-769-6449 (24 hours)

**ROYAL CREST**  
 13 Blade — 16 Function **SURVIVAL KNIFE**

Be ready for any emergency or adventure. You are prepared with this 3 3/4" **Royal Crest** 13 blade, 16 function survival knife, made from the finest surgical stainless steel. Handle is made of durable

Leymar. Tools consist of cutting blade, scissors, fish scaler, cap lifter, corkscrew, hook disgorging, reamer, manicure blade, sturdy reamer, phillips screwdriver, wood/rope saw, slot screwdriver, key ring, toothpick, tweezers, and can opener. Thousands of uses. Satisfaction Guaranteed, or return within 30 days for a full, no questions asked refund. **Only \$9.95 plus \$3.00 S/H. FREE SPECIALS: #1 FREE** with every order - **THE PERMANENT MATCH** - instantly lights indoors or out, even in strong winds. Get unlimited lights. Great for camping. **#2 FREE** - \$5.00 certificate toward any purchase from our camping/sporting catalog. **ORDER NOW!** Send your check or money order today to:

**J. V. ENTERPRISES** - Dept. 1S  
 P.O. Box 1033 • Somerset, NJ 08875-1033  
 (NJ Residents, add 6% sales tax. Please allow 2-3 weeks for delivery. Allow 10 days extra for personal checks to clear.)

- MALE POWER PACK.** Creates/builds muscle, strength, stamina, endurance. Can elevate testosterone level 200%! Enhances vitality. Safe. ON SALE: 1-800-878-8844. (199)
- INTERNATIONAL MILITARIA & CAMOUFLAGE,** 1993 Catalog \$1.00. I.M.S., Box 21606, Denver, CO 80221. (199)
- BEAUTIFUL MEXICAN WOMEN** seek romance!! Free photos, full information. LATINS, Box 1716(TN), Chula Vista, CA 91912. (619) 685-5195. (199)
- ASIAN WOMEN DESIRE CORRESPONDENCE!** Overseas, sincere, attractive, traditional. Free details! SUNSHINE INTERNATIONAL CORRESPONDENCE, Box 5500-ZH, Kailua-Kona, Hawaii 96745 (808) 325-7707 (204)
- R & R FOR SINGLE MEN.** Dream vacation with beautiful, playful Filipinas, as featured on "Inside Edition". BIG APPLE ORIENTAL TOURS (SOF), 24912 Elkmont Ave., Bellerose, NY 11426 (199)
- VIETNAM FIREBASE/Agent Orange** maps free! Vietnam, Korea, "Storm" maps catalog free! Send SASE. MONARCH, Box 42003-203E, Phoenix, AZ 85080. (1-602-530-8687, "Beck") (199)

**Street Lethal SPEED KILL**

Can you hit a man 11 times or more in one second or less?  
 Can you drop a man to his knees with one blow?  
 Can you win a fight in 3 seconds or less?

**WE TRAIN PEOPLE WHO CAN! FREE DETAILS**  
 Warrior Publications  
 6252 Dark Hollow Rd., Medford, OR 97501 (503) 535-3188  
**CUT OUT AND MAIL THIS AD TODAY!**

**Display Your Patriotism!**  
 ★★★★★★★★★★★★★★★★

American Eagle with magnificent wing spread. Italicized U.S.A. Sapphire blue, ruby red & white sparkling stars.

T-shirts (Choice of 100% cotton or blend) ..... \$16.00  
 Muscle Shirts (100% cotton) ..... \$16.00 plus \$4.00 S&H  
 Check or Money Order Design Front & Back or Front Only Black, White & Ash S-M-L-XL-XXL

Allow 4 to 6 weeks for delivery

**Business Card/ Logo CLOCK**  
 • Solid Wood Frame  
 • Quartz Movement  
 • (3) Year Warranty  
 Now Only \$39.99  
 Made with your business card or business logo or the Patriotic design 14" x 8 1/2"

**PATRIOTIC EAGLE T-SHIRTS**  
 P.O. BOX 9785  
 TULSA, OK 74157

**Dysfunctional Veteran leave me alone!**  
 m-xl t-shirt \$15.00  
 xxl-xxxl t-shirt \$20.00

School of Hard Knocks  
 Box 181-SOF  
 Cut-N-Shoot TX 77303-0181  
 School of Hard Knocks catalog \$2.00

**.625 MAGNUM™**

**-BEWARE-**

The World's Most Powerful Blowguns are **DOWN & DIRTY!**  
 Write or Call For Immediate Info.  
**J.W. McFARLIN COMPANY**  
 P.O. Box 209, Lake Havasu City, AZ 86405-0209  
 Tel. (602) 855-8095

- RETIRE WITH BEAUTIFUL GIRLS** in tropical paradises! Live like a king on \$300.00/month! DREAMGIRLS, P.O. Box 914, Islington, MA 02090. (199)
- PHOTO I.D. CARD** (50 states). Send photo, eye/hair color, height, weight, birthdate. \$15.00. MAXSELL, P.O. Box 23021, Ft. Lauderdale, FL 33307. (203)
- TEENAGE ASIAN GIRLS** desire men over 40! Marriages! 250 girl video \$17.95. TOURS ROYALE, Box 957, Deerfield Beach, FL 33443-0957 (199)
- LOST DOCUMENTS REPLACED.** College Degree, High School Diploma, Birth, Baptismal, Marriage, Divorce, Discharge Etc. SASE to MAXSELL, P.O. Box 23021, Ft. Laud. FL 33307 (200)
- BEAUTIFUL RUSSIAN WOMEN!** through overseas correspondence! eager, sincere and faithful! FREE 32 page - 500 photo catalogue. CLUB PRIMA, 13164 Memorial Drive, #233DD, Houston, Texas 77079. (713) 973-1515 anytime. (203)
- BEAUTIFUL, TRADITIONAL, ROMANTIC** Asian ladies desire friendship and marriage. Free photo brochure. ASIAN CONNECTIONS, Box 1230, LaGrange, TX 78945. (409) 242-5820. (199)
- ADVENTURE IN PARADISE!** Beautiful South Pacific Islands can be acquired for as little as \$200.00. For info write or call PACIFIC ISLANDS CONSULTING, P.O. Box 1010, Dept. B, Blue Jay, CA 92317. 1-800-854-0866 (199)
- RUSSIAN LADIES**, truly beautiful, educated, want to meet YOU. Free color photobrochure. Russiad4, P.O.B. 888851, Atlanta, GA 30356. (404) 458-0909. Anytime. (203)

**Clinton Sucks**  
 Red, White & Blue Design

First Amendment Products, Inc.  
 486 New Park Ave., Dept. SOF-054  
 West Hartford, CT 06110  
 Please allow 1-2 weeks for delivery

**SPECIAL SPRING SALE**  
**Heavyweight T-Shirts**  
 Small - XL ..... \$12.50  
 2XL - 3XL ..... \$14.50

**Buttons & Bumper Stickers**  
 Buttons & 3x4 or 5x7 Bumper Stickers \$2 for 1 / \$5 for 3 / \$10 for 7

**Ceramic Coffee Mugs**  
 \$8.00 for 1 / \$25 for 4

All prices reflect FREE shipping & handling CT Res. add 6% Sales Tax on Bumper Stickers & Mugs  
 Check or Money Order / Visa or MC \$10 min.  
**FREE Catalog with order or CALL 203-232-1595**

**NEWMAN'S G I SUPPLY**  
 R.D. #10 BOX 10419, NEWTON, NEW JERSEY 07860

**COMBAT ASSAULT VEST**  
 Woodland Camo  
**\$89.00**

5.56mm/7.62mm/9mm SMG  
 6 large pockets hold 12 30 rd 5.56 mm magazines, 12 7.62mm or 12 9mm SMG 2 chest accessory pockets 2 large inside pockets hold 12 more magazines, knife, pistol, etc. Attaching points on back for Alice Gear Quack release buckles One size fits all

Send \$3.00 For 200 Item Catalog! SEE US SHIPPING!

ORDERING INSTRUCTIONS: Money Order, personal checks or Visa & MasterCard gladly accepted. NO C.O.D.'s. All merchandise is 100% guaranteed. Residents of Alaska, Hawaii and Puerto Rico add 5% for shipping.

CALL (201) 948-6280

**PHOTO I.D. (ALL STATES) COMPLETE**

**ID ILLINOIS ID**  
 Registration No. 75107  
 • Thomas Diabaco  
 • 2205 Cornick Road  
 • Chicago, Illinois  
 M 151 960 Bk Bk  
 01.11.92 06.23.76

SEND Birthdate, Address, Height, Weight, Hair-Eye Color, Head Photo  
 Sealed in Plastic • Also International Driving Permit, Valid 161 Countries  
**YOUR CHOICE \$15.00**  
**MAXSELL CORPORATION**  
 P.O. Box 23021 • Ft Lauderdale, FL 33307 • 305-568-1480

**ISRAEL MILITARY PRODUCTS**

AIRBORNE T-SHIRT S-XXI \$11+\$3 POST  
 IDF WEBBING, HELMET, INSIGNIAS, UNIFORMS, T-SHIRTS  
 CATALOG \$2 (FREE WITH T-SHIRT ORDER)  
 IMP P.O.B. 31006, TEL AVIV 61310, ISRAEL

- ORIENTAL WOMEN** in Asia seek husbands. English speaking. No bargains. Direct contact. PACIFIC INTRODUCTIONS, 1 Corral Lane SE, Ashland, OR 97520. (199)
- LIVE 24 HOURS/DAY!!** Talk to beautiful girls! 1-900-407-2273 Ext.8705, \$3.99 per minute. Must be 18 yrs. Procall(602)631-0615. (199)
- SUPPRESSED INFORMATION:** Cable & Satellite Secrets, Electronic Surveillance, Locksmithing Secrets, Weapons, Investigation, I.D., and more. Free brochure: MENTOR, Box 1549-G Asbury, NJ 07712. (199)
- UNIDEN BEARCAT SCANNER.** Model BC800XLT, receives police, fire, aircraft, ambulance, race cars, public service, plus cellular phone calls, 40 channel base, also runs on 12 v dc, one year factory warranty, the BC800XLT will not be manufactured in the future due to the federal law banning the manufacture of radio scanners capable of receiving cellular phone frequencies. MasterCard, VISA, COD cash only, \$229.99 plus \$8 shipping each. SCANNER WORLD USA, 10 New Scotland Ave, Albany, NY 12208. Phone (518) 436-9606. (203)
- WESTERN WARRIOR RELIGION.** Rather be a wolf than a sheep! Odin and Thor are our Gods; courage, liberty and individualism our values. Warrior Booklet: \$4.00; magazine sample: \$2.50. Write M. HUNTER, P.O. Box 445, Nevada City, CA 95959. (199)
- CONCEALED WEAPONS PERMIT!** If you're carrying only concealed weapons, this could save you from arrest! Send photo, desired name, \$15.95, to CAS, P.O. Box 2806-455, Torrance, CA 90509. (199)

**SECURITY PRODUCTS**

**FREEDOM TELEPHONE CARD.** Global Communications. No records. Untraceable. Private. No 900 number blocks. 800 number access. Only \$30.00 for 60 minutes. Cash, Check, Money Order. FREEDOM, P.O. Box 11114, Chattanooga, TN 37401. (200)

## SOLID BRASS PAPER WEIGHTS

Made from 1/2 lb of solid brass. Polished to a smooth finish.

**\$12.95 Each or 2 for \$22.50**

Send check or money order plus \$4.00 Shipping & Handling to:  
 Bud K World Wide  
 P.O. Box 565 Dept SF  
 Moultrie, GA 31776

MC or VISA call  
**1-800-543-5061**

## TELEPHONE LISTENING DEVICE

Record telephone conversations in your office or home. Connects between any cassette or tape recorder and your telephone line. Starts automatically when phone is answered. Records both sides of conversation. Stops recorder when phone is hung up.



542 1cu. in.

**\$19.95 EACH** Qty Disc Avail

## Super Powerful FM TRANSMITTER

Many times more powerful than other transmitters. Transmits up to 1/2 mile to any FM radio - Easy to Assemble KR - up to 9V battery (not incl.)

For catalog of Transmitters, Voice Scramblers and other specialty items, enclose \$2.00 to USI Corp  
 Call 407-725-1000 or send \$19.95 + \$1.00 shipping per item to: USI Corp, P.O. Box 8F-2052, Melbourne, FL 32902 COD'S OK

## World's Most Fascinating Police Catalog!

112 pg. Catalog  
 Badges; ID Cards;  
 Books; Clothing;  
 Ammo; Weapons  
 Spy Equip; Posters;  
 Hats & more!

World's Best Catalog!



Send \$3.00 for Catalog, or Call 1-900-226-2444 for RUSH shipment! FREE \$3.00 Coupon included with each catalog!

NIC, inc. Box 5950-FC, S port, LA 71135; (318) 688-1365

## MEET WOMEN WORLD-WIDE

FREE 32 page photo catalog from America's most respected correspondence service since 1974.

### CHERRY BLOSSOMS

190FT Rainbow Ridge  
 Kapaau, Hawaii 96755  
 1-408-980-7488



## NIGHT VISION EQUIPMENT

NIGHT VISION FROM \$279. Our prices ALWAYS lowest! Don't pay for their expensive picture advertising. Moonlight Products are BRAND-NEW, YEARLONG WARRANTY. Manuals, lenscaps, carrycases, batteries, included! Devices marked with "I" have Infrared Illuminators. SCOPES: MPN1000, \$279; MPN1400, \$349; MPN1500, \$389; MPN1000-I+, \$399; MPN1400-I+, \$399; MPN1500-I+, \$489. POCKETSCOPES: Moonwalker, \$349; Moonwalker-I, \$399. BINOCULARS GEN II: MPN30K, \$549. WEAPON SIGHT GEN II: MPN90K, \$1179. WEAPON SIGHT GEN III: MPN95K, \$1295. SCOPE GEN III: MPN60K, \$895; Illuminator, \$79. New! State-of-the-Art Gen III Goggles/mask: MPN50K-I \$1695. Visa/Mastercard accepted. Cash Methods 2.25% discount. BOEKE, 407 Melbourne, Columbia, MO 65201. Card orders, Catalog, 1-(800)-55-BOEKE. Call for latest pricing. (199)

## REMAILING SERVICES

CONFIDENTIAL ADDRESS. Mail received here, then forwarded to you worldwide. Valcemail, Tool MAILPOST, 2421SOF Pratt, Chicago, IL 60645 (312) 764-0100, (800) 890-3199. (199)

## SURPLUS

MILITARY CLOTHING, GEAR, BOOTS, JACKETS, Collectibles, etc. Call (408) 295-1136 for FREE catalog or write: LEE-JACKSON MILITARIA, P.O.Box 8663, San Jose, CA 95155. Foreign catalogs are \$3.00. (200)

MILITARY SURPLUS & SURVIVAL ITEMS; Large Inventory, new and used. Mail \$1. (refundable) for price list: HUGH WADE'S, 2120 West Reeffoot Ave., Union City, TN 38261-9732. (199)

MILITARY SURPLUS. New and used, also survival items. Send \$2 for catalog. REMA MILITARY SURPLUS, P.O.Box 7039, Canton, OH 44705. (199)

GOVERNMENT SEIZED Security Equipment, Tents, Cars, Trucks, Boats, Computers. Surplus Bargains Galore! Your Area. Toll Free information: 1-800-601-2212. SP7770. (199)

## Need NEW ID ? CREDIT • PRIVACY

OUR BOOKS HELP YOU GET: New identity & credit.  
 • Jobs in 48 hours. College degrees. ID by mail.  
 • Cash income. Private loans. Asset protection.  
 • Offshore banking. Foreign passports & MORE!

FREE 40 pg. PRIVACY CATALOG: 800-338-8484  
 EDEN PRESS • Box 8410-PS • Fountain Valley, CA 92728

## Genuine RAMBO® Knives

Each only **\$88.50** plus \$4 shipping & handling



The only LICENSED reproductions. Each blade is 1/4" thick. Rambo I & II have hollow handles complete with survival kits, liquid filled compass on inside of butt cap, saw teeth (that really work) on backside of blade and bladeguards that feature phillips head and standard screwdriver points on each end.  
 Rambo I measures 14" with a 9" blade.  
 Rambo II measures 15 3/8" with a 10" blade.  
 Rambo III measures 16" and features full-tang construction and an anti-glare sighting slot in its 11" blade. The superior design of its hardwood handle fits beautifully in your hand. Each comes with a top-grain leather sheath and a full-color gift box. Money-back if not completely delighted. Send check or money order to:  
**SPOTLIGHT SPORTS CO.**  
 P.O. Box 1050  
 Saugus, MA 01906

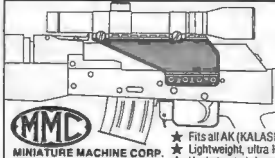

## MMC UNIVERSAL AK SCOPE MOUNT 39.95

- ★ Fits all AK (KALASHNIKOV) type firearms
- ★ Lightweight, ultra low profile & rigid
- ★ Unobstructed view of iron sights over mount
- ★ Field stripping capabilities retained with scope and mount in place

MINIATURE MACHINE CORP.  
 508 Grace Avenue Dept. SOF  
 Ft. Worth, Texas 76111  
 (817) 831-0637

## PISTOL CROSSBOW

- Very Powerful • Portable
- Pinpoint Accuracy
- Outstanding Performance



Features: Diecast Gun Body, Polyester String, Adjustable Sights (wind, elev), Suspension Steel Bow, 5 Aluminum Tipped Bolts, EZ-Hand Cocker target included and 45LB draw  
 Spare String \$5.00; Spare Bolts (10 pack) \$7.00  
**\$34.95 or 2/\$31.95 Ea.**  
 Ck/MO plus \$5.00  
 S/H Guaranteed

S.R. BARCLAY, P.O. Box 370024, Denver, Colo. 80237

G.I. SURVIVAL VESTS, ammo vests, WWII snow shoes, 1944 medical dept wool creme color blankets, Korean War mountain mess kits, G.I. field tents, camo net systems. In continental U.S. write for free catalog. Foreign catalogs send \$3.00. AA SURPLUS SALES, 2940 E. Olympic Blvd., Los Angeles, CA 90023 USA. 1-213-526-3622. (199)

## SURVIVAL

SMOKE BALLS, CARTRIDGES, Candles, Bombs, Pots, Grenades. Largest selection anywhere. Write for 56-page catalogue of 500 products. U.S.-\$3.00, Canada-\$5.00, Others-\$10.00. SIGNUS, Box 33712-W51, Phoenix, AZ 85067 (199)

WANTED: Bushwackers, Revolutionaries, Pirates, Bounty Hunters, Soldiers, Men who are TRULY TOUGH! you NEED our book catalog! Mail \$1.00 to: GADDIS PUBLICATIONS, P.O.Box 411746-SOF, Los Angeles, CA 90041. (199)

## TRAINING

BOUNTY HUNTER TRAINING by professionals; on-site in Florida or at country-wide seminars. Details. NABEA, P.O.Box 6757, West Palm Beach, FL 33405. Phone: (407) 547-3630. (199)

RANGER, AIRBORNE, Bodyguard Training. Catalog and Information \$7.00 (\$12.00 Foreign). USTC, 2024 N. Broadway, Suite 205, Santa Ana, CA 92706-2623. (714) 547-2567. (199)

## EMERGENCY PASSPORTS

TRAVEL INCOGNITO

AFRAID TO TRAVEL AS AN AMERICAN? NEED ALTERNATE IDENTIFICATION? FOR TRAVELERS AFRAID OF BEING SINGLED OUT BY TERRORISTS, HIJACKERS OR KIDNAPPERS, WE OFFER PASSPORTS FROM SIX COUNTRIES. "AN AMERICAN - NOT ME!"

CUSTOM MADE LEGAL SECOND PASSPORTS WITH YOUR PHOTO AND PERSONAL INFO PLUS TWO BACK-UP I.D. CARDS - \$125.00

## SAFGUARD SERVICES

P.O. Box 689-F Ely, NV 89301  
 (702) 289-4229

## CANADIAN VIETNAM VETERANS QUEBEC MEMORIAL NEEDS YOUR SUPPORT

T-shirts (black or blue) \$18.50  
 Sweatshirts (black or blue) \$27.00  
 Patches (Vet or supporter) \$5.50-Plus \$6.00 (all pdd)

Address your donations to the CVVQ and your orders to: ROVEND, 5740 Coolbrook Avenue Montreal, Quebec, Canada H3X-2M1

## CUSTOM PATCHES, PINS, DECALS, CAPS

CUSTOM PATCHES PINS DECALS CAPS



HIGHEST QUALITY LOWEST PRICES

## FREE CATALOG & SAMPLE

STADRI 71SF Tinker SL, Woodstock, NY 12498  
 914 679 6600 Fax 914 679 6649

## FREEDOM COUNTRY



20 BIG acres in WESTERN MONTANA, starting at \$9850. Trout fishing, backpacking, camping. Elk, deer, moose, bear. ADJACENT to National Forest, near established towns. Yellowstone and Glacier National Parks nearby. GUARANTEED ACCESS, INSURED TITLE, WARRANTY DEED. FREE color brochure, photos, maps.

FULL MONEY-BACK GUARANTEE  
 "Video Available"  
 CALL TOLL FREE 1-800-592-5990  
**TREASURE STATE RANCHES**  
 210 Milwaukee Street, Dept. 8  
 Deer Lodge, Montana 59722 - (406) 846-1000

## THE SPOOK BOOK

A Strange & Dangerous Look at Forbidden Technology

Mick Tyner

The book that blew the lid off Forbidden Technology! Building Teflon-coated bullets, re-arming inert grenades, secrets of titanium warheads, hyper-secure encryption, rocket weapons, clandestine pyro oxides, wearing a wire, defeating alarms, forbidden tech marketplace, surveillance photography, computer viruses, scrambling/decrypting, ultrasonic weapons, much more! 8.5x11, 258 meaty pages, a fresh & lucid look at Forbidden Technology! \$33 domestic postage paid. Registry Distributing, 200 Union Blvd, Suite 430, Denver, CO, 80228. Sold only to inform.

NAVY SEAL FITNESS PROGRAM. Gain strength and self-confidence. Get in shape using the methods of the world's most elite combat unit. Send \$10.95 to T-N-S ENT, P.O.Box 16297, Seattle, WA 98116. (202).

## VIDEOS

YOUNG VOLUPTUOUS NUDE Models. Videos from Russia, Asia, Latin America, Europe, Scandinavia, Arab@ll "Cherry Girl Series". Sample \$19.95. 37 Country PhotoLog \$1.00. T.L.C. Box 330, Deerfield Beach, FL 33443-0330. (199)

## WANTED

PROFESSIONAL BODYGUARDS & INVESTIGATORS! If you feel you have the potential to earn \$80 per hour. If you are professional and can assimilate confidential information. ACT NOW! Send \$10 for full information package to B.A.S.E.C., P.O.Box 147, Convention Station, NJ 07961-0147. (203)

# PARTING SHOT

Just Duel It

by Steve McCue

Now that capital punishment, that politically correct euphemism for execution, has made a stunning comeback in American society, it's time we reviewed some of the other past traditions for controlling the aggressiveness of unruly citizens.

Some have proposed that public executions would impress the reality of death on the cretin consciousness of would-be criminals. Others hold that TV already makes death all too popular and common, and think a public execution channel would draw fewer viewers than C-Span. Personally, I can't speak to punishments and deterrents; I was so bad at spanking my kids they usually laughed when threatened. But I can propose a long-forgotten custom that might have real appeal to a nation hungry for just retribution as a good deterrent.

Dueling, that lost art, could once again fit comfortably into the fabric of modern America. I'm not talking about those dumb Western shoot-outs in Deadwood or Durango. I mean classy, formal dueling, with a glove across the face, at the crack of dawn with seconds, etc. For those who think it's inconceivable to envision such a revival, let me just ask: Did you ever think high school Home-Ec teachers would hand out condoms on Friday night and urge kids to have a good and/or safe time?

The possibilities are endless: Teddy Kennedy calling out Rush Limbaugh. Bill Clinton calling out ... Well, he could have Hillary handle it.

Dueling could bring fairness back to homicide. Gangs could pick their best shots, take over Yankee Stadium and televise the event. Feral carloads of punks protecting their turf with UZIs — a distinct public hazard — wouldn't be necessary. Plus, cops could become heroes by teaching dueling in gyms much as they now teach boxing through the Police Athletic League.

Even though the country has a proud history of dueling — with President Jackson a veteran survivor of several, and our first secretary of the treasury being killed by a potential presidential candidate (Aaron Burr shot Alexander Hamilton) — I would bring the practice up-to-date. Women would be afforded equal opportunity with a special affirmative action program to encourage intergender dueling. Actually, such a program may not be necessary.

Dueling could be offered as an alternative to divorce courts. The results would be so much clearer to the surviving kids, and the tykes wouldn't have to worry about which parent to choose to live with. Problems with child support would be resolved, since the departed parent's life insurance would take care of the kids and send them to the college of their choice. Property division would be simple: Winner takes all.

As with any innovation, there would be some

segments of society that would not do as well under the dueling system. Lawyers would tend to lose control of adversarial cases, but what they lost in civil cases could be made up in building an entire new body of dueling case law. After all, what happens if one party is only maimed in the duel? Whose "deep pockets" would maintain life for a disabled dueler? What about stray shots that nail a spectator? I don't know what the personal liability section of my homeowner's policy says about dueling, but I do know it covers me if I sock some guy in the snoot, so it ought to cover me if I shoot someone in a duel, too. I believe it wouldn't take long before attorneys of all sorts would be earning just as much, if not more, than they did before dueling was reinstated.

I would put *some* limits on dueling: Weapons must be government inspected and carry caution labels stating that dueling could be dangerous to your health. Also, pregnant women and children under 16 (save members of a gang with written parental consent) would be barred from the activity, as would the visually impaired.

Dueling should be discouraged between siblings and in fact *any* blood relatives: Normal murder would still suffice to resolve intrafamily disputes. As I said before, dueling ought to be encouraged among the married. Also, admission charges should not be allowed — after all we wouldn't want a real good shot going 'round calling out everybody in town: Professional pistoleros would do to judicial duels what lawyers have done to trial courts. Also, dueling should not be allowed on holidays or prior to church services on Sunday. Wagering would only be allowed on Native American reservations and Donald Trump would not be allowed to participate except as a dueler himself. Provoking speech and gestures, such as "Make my day" or the Rockefeller salute would be disallowed and a penalty of one free shot levied against the perpetrator.

There would be some exceptions regarding charging for admission. If any politicians (to include zoning and school board members) are involved in a duel, admission should be charged and the revenues applied to reducing the deficit, whether it be local, state or federal. In an instance where both politicians get off a lucky shot, their combined insurance assets would go to government debt reduction. Also, on the international scale, heads of state who quarrel would be encouraged to duel before declaring war. In fact, the U.N. charter should be amended to assure that such contests take place — no stand-ins accepted.

Details that need to be orchestrated are legion: the regulation of dueling weapons, life insurance considerations, the effect on any national health plan and so on. Eventually it would all work out, I'm sure. ✕

**The possibilities are endless: Ted Kennedy calling out Rush Limbaugh. Bill Clinton calling out ... Well, he could have Hillary handle it.**

# SURVEILLANCE

## Pinhole CCTV Camera System

Complete pinhole system includes; 4mm pinhole lens, mini-CCD camera, mount, B&W monitor, cable, power supplies and a 24-hour time lapse VHS recorder. Retail \$3,650. **SALE \$2,495** (ship/ins \$35).

**Disguised cameras from \$495.** (Smoke detector, emergency lights, etc.)



**COVERT VIDEO SPECIALISTS**

Wireless Video Transmitters & Receivers. Call.

Complete CCTV system design and installation available worldwide.

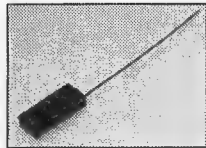

## Match Box Transmitter

**TK-100 Tuneable FM Transmitter Kit\* with matching receiver \$199** (ship/ins \$7).

**TK-500 UHF Crystal Controlled Professional Transmitter Kit\* \$349** (ship/ins \$7). Available

on two frequencies. Extra lithium batteries \$8 each. **Professional High Gain Two Channel Receiver \$1,200** (ship/ins \$20).

## Telephone Transmitter

**TK-200 FM Tuneable Transmitter Kit\* with tunable receiver \$199** (ship/ins \$7).

**TK-600 UHF Crystal Controlled Professional Quality Transmitter Kit\* \$399.** Two frequencies available. Works with scanner or professional high gain receiver.

**\*NOTICE: Transmitter kits require simple (10 minute) final assembly.**

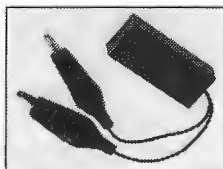

- **Body Wire and Receiver Set \$299** (ship/ins \$10)
- **Body Wire Detector \$695** (ship/ins \$10)
- **Complete Basic Countermeasures Kit \$1,495** (ship/ins \$35)
- **Tap Nullifier. Jams telephone taps. \$695** (ship/ins \$10)

## Audio Surveillance Kit

Includes;

Body wire and receiver,  
VHF crystal controlled  
Telephone recording system  
Mini microphone w/amplifier  
and 25' cable  
FM Match Box Transmitter Kit  
FM Telephone Transmitter Kit

Receiver for FM Transmitter  
Touch Tone decoder  
Call Logger  
Lineman's handset (telephone)  
Contact microphone  
Telephone Infinity Ear  
Taps & Bugs Video

Assembled in a briefcase. **\$1,495** (ship/ins \$25).



## Telephone Recording System

Complete system includes; extended play recorder, 140 minute cassette, power supply, telephone interface for standard single and multi-line telephones, alligator clip adapters for attaching the recorder anywhere along the telephone line. Includes everything you need to record your calls.

Starts and stops automatically. Voice activated. Optional "beep" mode. **EP-500 Telephone Recording System \$195** (ship/ins \$7).

Record for 12 hours with EPPI's **Professional Model Pro-12 Telephone Recording System \$399** (ship/ins \$19).

- **Call Logger II** - keeps an electronic record of all OUTGOING calls (phone numbers) made from any single line telephone. Even shows local numbers that your phone bill won't. Attaches anywhere along the line. **\$189** (ship/ins \$10).
- **Telephone Taps and Room Bugs.** How they're done and how to defeat them. Surveillance expert reveals trade secrets, step by step. Shows many of the actual devices. One hour VHS **\$49.95** (ship/ins \$4).
- **Israeli Instinctive Combat Shooting Method.** One hour step by step lesson. Filmed in Israel. VHS. Retail **\$49.95 Limited Offer \$29.95** (ship/ins \$3).



## KGB Photo Sniper System

Camera, shoulder stock, 300mm lens, filters, carrying case etc. A tremendous value. **Only \$599** (ship/ins \$25). This is THE system used by surveillance teams in former East Block Countries.



## Night Vision

### WARNING!

**Not all Russian night vision is equal. Don't get burned buying cheap junk or units that produce dangerous x-rays.**

- Binoculars
- Riflescopes
- Handheld viewers
- Complete camera systems

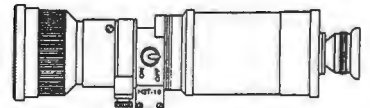

**Invest in quality at excellent prices. Call EPPI.**

NOTICE! These products are intended and sold only for the purposes of testing and experimentation and training in electronic countermeasures. Any other use may be illegal. FCC licensing may be required prior to assembly. Not to be used for surreptitious interception of oral communications. All equipment is sold subject to public law 90-351, title III, 18 U.S.C. Section 2511. All local, state, and federal ordinances, rules, regulations, etc. It is the sole responsibility of the buyer (not the seller) to consult legal counsel for interpretation of any laws applicable to the area of intended use.

Catalog  
\$5



## Surveillance/CounterSur.

Hands-on Seminars

Two days - held bi-monthly

**\$495**

**Call for dates and reservations**

**Executive Protection Products, Inc. - The Professionals**

1325 Imola Ave. W. #504S, Napa, CA 94559 707-253-7142 FAX 707-253-7149 MC/Visa



**NO POSTAGE  
NECESSARY  
IF MAILED  
IN THE  
UNITED STATES**

**BUSINESS REPLY MAIL**

FIRST CLASS MAIL

PERMIT NO. 8

MT. MORRIS, IL

POSTAGE WILL BE PAID BY ADDRESSEE

**SOLDIER OF  
FORTUNE**

PO BOX 348

MT MORRIS IL 61054-9817

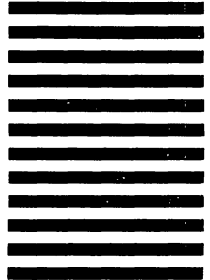



CAR-15



Photo by Stan Trzoniec, Harris Publications

ULTRAMATCH™

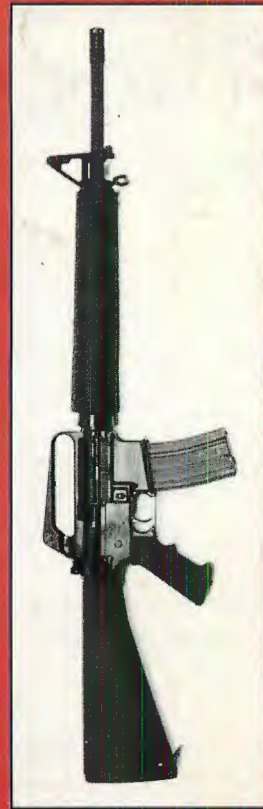

AR-15

**Unequaled Quality in  
12 Interchangeable Calibers  
• Originators of the Tactical Pac® •**

*Manufacturers of America's Best —  
for America's Best*

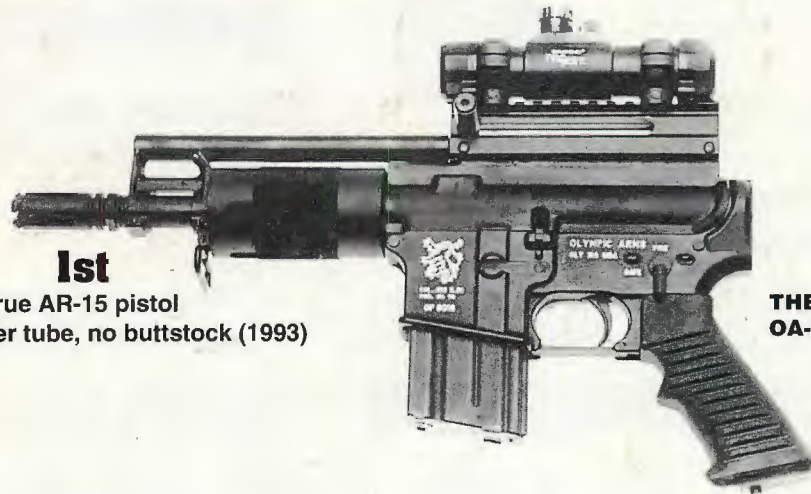

**1st**  
true AR-15 pistol  
with no buffer tube, no buttstock (1993)

**THE  
OA-93™**

**Quality for the Professional at a Reasonable Price**



***Olympic Arms / Safari Arms / SGW, Inc.***

624 OLD PACIFIC HIGHWAY SE

OLYMPIA, WA 98503

Phone (206) 456-7940 • FAX (206) 491-3447