

JANUARY/78

\$2.00

SOLDIER OF FORTUNE

THE JOURNAL OF PROFESSIONAL ADVENTURERS

SOF Exclusive:
NEW SIDEWINDER SMG



Exclusive:
**AFRICA IS
BURNING!**

SPOTLIGHT FRIENDSHIP TOUR No. 2

This time we take you to southern Africa

... with optional side trip to Rhodesia

... and home via Rio.

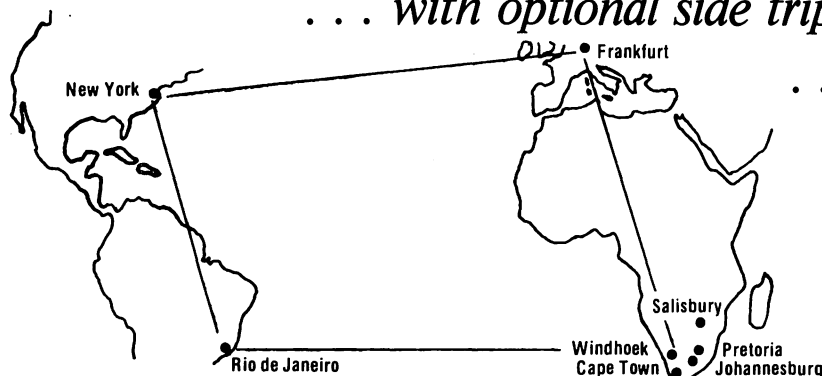

And away we go . . . once again!

Here is an incomparable **20-day luxury tour to South Africa, Rhodesia and Rio de Janeiro!**

We are scheduled to depart from **New York for Frankfurt November 4.** Our first stop is **Windhoek, South West Africa**, an isolated area rarely seen by tourists. South West Africa has been recently much in the news because of the demand of the UN that it be taken away from the South Africans.

Few people realize that this area has more diamond mines in it than any place else in the world and that its population, composed of many divergent races and groups, had always been an anthropologists's bonanza. You will meet friends in Windhoek and after two days will leave for **Johannesburg, arriving on the 9th.**

Then—if you are up to it—you can take an optional spur to Salisbury, Rhodesia and participate in their UDI freedom celebration November 11. You will meet some of the finest and most courageous people in the world fighting for their liberty.

Those who stay in South Africa will also have a full itinerary to points of interest, including famous **Krueger**

Park. On November 14 the tour will assemble in Johannesburg and board the famous and luxurious Blue Train for a ground-level flight to **Cape Town.** After a day in **Cape Point** on **November 17** the group will go to Johannesburg again—this time by airplane for **Pretoria**, the capital of South Africa where many interesting events are planned.

On Monday, November 21, we will take South African Airlines across the rolling South Atlantic Ocean to **Rio de Janeiro**, arriving at 4:15 p.m. Two days are planned in Rio to add to your suntan and to your friendships because you will be meeting leading Brazilian patriots. The return trip to **New York** via Pan Am will follow with arrival **Wednesday morning, November 23.**

Spotlight Friendship Tours are designed not only for fun and recreation to give you a vacation you can remember the rest of your life but also to establish friendships between patriots of all nations. They also provide The SPOTLIGHT with the means of finding facts, creating a valuable background against which news can be interpreted for 250,000 American readers.

Here's your chance of a lifetime! Take a well-earned 20 days next November and join us on the second Spotlight Friendship Tour! To assure your reservation, a \$200 deposit is required on the \$2,436 package price which includes deluxe hotel accommodations, continental breakfasts, gratuities, bus and train tickets and all meetings and receptions. Your reservation is fully refundable up to six weeks before departure time.

And don't forget to make sure that your passport is valid

Spotlight Friendship Tour #2
300 Independence Ave., S.E.
Washington, D.C. 20003

I'm interested in the 20-day luxury tour to South Africa, Rhodesia and Rio.

I'm ready to go. Here's my \$200 deposit (per person) which I understand is refundable at any time up to six weeks before the tour leaves.

Please rush me full information before I decide.

Name _____

Address _____

City _____

State _____ Zip _____

My phone is: (____) _____

THE SURVIVOR Volume I — \$6.00

Now in one bound volume, the first year's issues of THE SURVIVOR. Includes survival, back to the land, cottage industry, improvised weaponry, kitchen chemistry, 19th century science and mechanics. This is a wonder book of modern survival knowledge combined with 19th century techniques for doing just about everything for yourself. Whether you are a craftsman, artisan, tradesman, or are unskilled at anything, THE SURVIVOR will show you how to become independent and self-sufficient. Build a workshop out of scrap, a mad scientist's laboratory with odds and ends, cut your food bill, and free yourself from our tottering parasitic system.

If you have more confidence in yourself than in politicians or in "patriotic" organizations, THE SURVIVOR is for you. It cuts through all the garbage you read about what "we" can do for the world and this country. It puts YOU in the center of the picture and tells what you can do to insure the survival of yourself and those closest to you in the coming chaos. Completely indexed.

GRANDDAD'S WONDERFUL BOOK OF CHEMISTRY—\$10.00

Cottage industry is the way for you who have given up on our sprawling, mindless, polluting industrial complex. But methods of home manufacture are hard to find and generally inadequate to the needs of the beginner.

Families of the last century could make, in their own homes and shops, nearly everything they needed, so why can't you? The reason is simple. Their methods were largely lost as fast as industry took up the mass production of the people's needs. The old formularies also had their drawbacks for today's reader. Their terms were archaic, even medieval. (This book defines up to 2500 obscure trade, chemical and technical terms.)

Atlan Formularies has made a breakthrough with GRANDDAD'S WONDERFUL BOOK OF CHEMISTRY. Reading this book is not only like going into the past, but it's putting you there, with all the independence from the establishment that Granddad had. You can make anything he made, just as good or better. Plus complete laboratory glass blowing course.

Four New Tools For Your Gunbench!

**From
ATLAN**

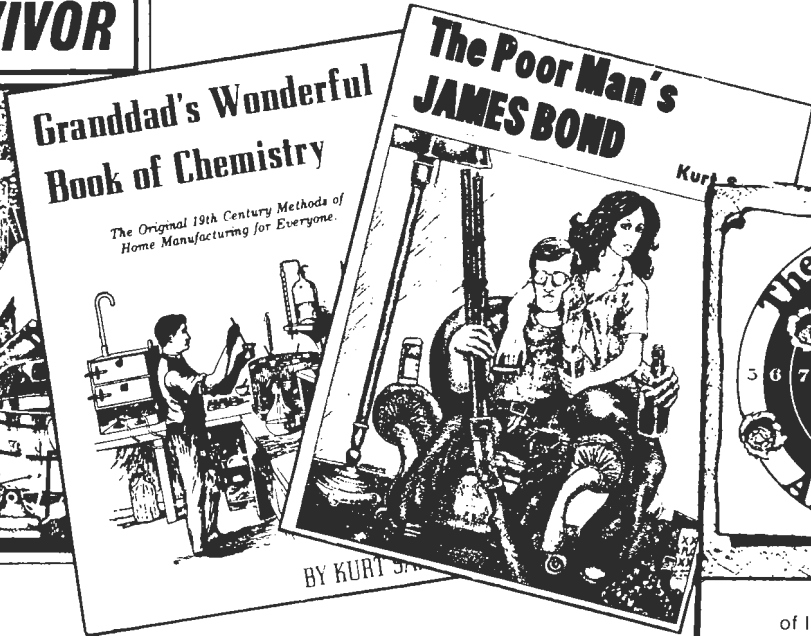

**YOUR WORKSHOP IS A GOLDMINE WITH ATLAN PUBLICATIONS!
MAKE YOUR OWN WEAPONS, TOOLS, AND CHEMICAL PRODUCTS.**

Our line of books is not for armchair adventurers or gunshop commandos. ATLAN is for gunsmiths, weapons makers, kitchen chemists, home mechanics, and ANYONE determined to SURVIVE in our shaky and uncertain future!

THE POOR MAN'S JAMES BOND —\$10.00

THE POOR MAN'S JAMES BOND is the undisputed leader in the field of books on improvised weaponry and do-it-yourself mayhem. It gives full and simple instructions for making tear gas, explosives, firearms, silencers, poisons, zipguns, grenades, knock-out drops, flame throwers and a wide variety of weapons. It also tells you how to buy most of the needed chemicals from your grocery and garden store. Includes: FIREWORKS AND EXPLOSIVES LIKE GRANDDAD USED TO MAKE. This book has hundreds of formulas and processes for making fireworks, blasting compounds, gunpowder, nitro, guncotton, etc. The material was gleaned from formularies written from 1872 to 1907. Plus: George W. Weingart's classic on fireworks, PYROTECHNY. This is the simplest and most comprehensive book on actually making fireworks. It is heavily illustrated in how to make Roman Candles, Shell Cases, Fuses, Colored Fires, Explosive Powders, Rockets, Mortars, Firecrackers, Torpedoes, etc. Plus: the complete text of EXPLOSIVES, MATCHES AND FIREWORKS by Joseph Reilly, 1938. This is a rather technical work on the analysis and testing of explosives. All these combined make THE POOR MAN'S JAMES BOND invaluable for survival.

THE POOR MAN'S ARMORER — \$10.00

The Only Magazine of Improvised Weaponry

Silencers, Rockets, Mortars, Automatic Weapons, Bazookas, Armor Piercing Ammo and much more are easy to make at home with simple hand tools and the PMA. We don't print gun control sob stories, product reviews of \$1000 rifles or mercenary fantasy tales; only simple easy-to-understand articles on homemade weapons. All projects can be done in your own home workshop or even at the kitchen table. Most materials needed are available at the local hardware store or hobby shop. Each issue also contains information or sources for gunparts, chemicals, books, tools, and other hard to find materials.

These articles appear in Issue #1:

THE COMBAT PISTOL TARGET, LADIES' CHOICE—SELF DEFENSE FOR WOMEN, THE WALKING STICK SHOTGUN, BAZOOKAS—PART I, SILENCED BRIEFCASE PISTOL, THE CO2 BOMB, HOW TO MAKE NUNCHAKU STICKS, BARGAIN BUGGING, FIVE DOLLAR BOOT KNIFE OR PUSH DAGGER, 1890's BODY ARMOR, THE GUNSHOP—PART I—SIMPLE GUNSMITHING TOOLS, IMPROVISED SILENCER MOUNT FOR ALL GUNS, GRENADES.

California add 6% Sales Tax	
The Survivor—Volume I	\$ 6
Granddad's Book of Chemistry	\$10
The Poor Man's James Bond	\$10
The Poor Man's Armorer	\$10
Total Enclosed	

Order From:
ATLAN "G" FORMULARIES
P.O. Box 438
Eureka, California 95501

Name	
Address	
City	State
Zip	

MERCENARY'S MANUAL

MERCENARY'S MANUAL PART TWO

By Terry P. Edwards. Edited by Robt. K. Brown.

Photos by Gary Flanagan and Al Venter.

300+ pages, 150+ photos, dozens of illustrations.

5½ by 8½. \$8.95 plus 75¢ postage.

Books don't make soldiers. And no one can sell you all the stuff that does. But these days it takes more than guts and muscle to win battles. Mercenary's Manual Part Two gets to the details; the how-to-do-it side of urban war, anti-tank fighting, mortars, missiles, climbing, tracking, and more. There is more on demolitions, small-unit amphibious and air operations, weather predictions, mines, and much more. Part Two is over 300 pages, with dozens of line drawings and over 150 photos by Gary Flanagan and Al Venter. It does not deal in entertainment, politics or terrorism, just down-to-earth proven methods and techniques. It's plain know-how . . . dedicated to winning. It costs \$8.95 plus 75¢ for postage. This much we can sell you. The rest is up to you . . .



PART TWO

- **URBAN WARFARE** — The hows and the whys of a deadly business. Tactics, tricks and facts on attack and defense in street fighting.
- **ANTI-TANK WEAPONS** — The specifics on operating the Carl Gustav RCL, TOW, RPG-2, RPG-7, Dragon, Sagger, 3.5 RL, 57 & 106-mm RCL, PZK-44, Strim, Entac, and others. The information you need to get them into action and on target.
- **ATTACK AND RETREAT** — Methods of control, phase lines, checkpoints, etc. Assault drills, vehicle drills, principles of success, operating with tanks, and more.
- **WEATHER** — How to predict what's coming; essential knowledge for anyone concerned with operations.
- **TRACKING** — What to look for, where to find it and what it can tell you.
- **MINES** — How to employ them, how to lay them, how to find them. How mechanical, chemical, pneumatic and hydrostatic fuses work. Countermeasures. Includes identification of 72 different mines.
- **CLIMBING** — A review of the tools and techniques to get you up, over and down: Alive.
- **COMMUNICATIONS** — In one place, morse, semaphore, emergency panel codes. Improvised antennas, how to extend your radio range, how to operate the sets you may encounter.
- **RECON** — How to do it right; covering route, bridge, cross-country and target recon. Determining range, corner radius, and more.
- **ANTI-TANK** — Tackling tanks without the proper AT weapons. Not recommended practice; but, if your back's to the wall . . .
- **IMPROVISATIONS** — Page after page of tricks and expedients from hardening soft vehicles to making an improvised AT discriminator.
- **FINANCIAL SELF-DEFENSE** — Identifying gold, diamonds and counterfeit currency. The ins and outs of "odd" methods of payment, Swiss banks, etc.
- **AIR OPERATIONS** — How to pick, measure and mark a drop zone, create a forward or clandestine airstrip, or helipad. The facts and formulas you need to figure it all out. Even a section to help the novice jumper through his first jump.
- **MORTARS** - How they work, how to set them up, how to direct their fire. Operating details for the IMI 50-mm, the Tampella and Hotchkiss-Brandt 60-mm, the M-19, British 2-inch and others.
- **AMPHIBIOUS OPERATIONS** — From patrolling rivers and streams to open water landings; the tactics and methods. Mounting weapons on a small craft, safety, and even details on wave and tide characteristics.
- **TANK RECOGNITION** — Photos and facts covering the major tanks, APCs, armored and scout cars in use around the world today.
- **DEMOLITIONS** — Ditching, breaching, cutting . . . steel, concrete or earth. Buildings or bridges. The formulas you need, the details in your pocket.
- **FIELD FORTIFICATIONS** — Construction of shelters from foxholes to bunkers. How to lay out your defenses, tank stoppers and more.
- **NBC** — The bomb, biological war and chemical attacks. What can be used, how to avoid being affected and what to do if you are caught in an attack.

This is only a partial listing of what the sections cover; there is too much to list. A bibliography is provided to direct the reader in further study. The concept of the Mercenary's Manual is simple: Cram in enough facts to make it work!

THE ORIGINAL MERCENARY'S MANUAL

The most compact guide to combat survival is still available at the same price, \$4.95 plus 60¢ for postage.

Part Two tells you how to carry the war to the enemy, but Part One is intended to keep you alive to do so. It's concise: 130 easy-to-read pages packed with tips, photos and illustrations. Operating instructions for a dozen small arms and over a dozen grenades are included. If you're serious about the business, you need this book.



UPCOMING TITLES

FIGHTING PATROLS — Gary Flanagan takes an in-depth look at the essence of modern war: the fighting patrol.

GUNS IN A HURRY — World War Two turned firearms production upside-down and no guns epitomized the new techniques like the submachine guns. This is the story of guns in a hurry: the Stens, the Grease Gun, the MP-40 and the PPsh. G. N. Dentay and T. P. Edwards.

UNIT NINE
1110 FINCH WEST
DOWNSVIEW, ONTARIO
CANADA

All orders are mailed first class. Those outside North America please include additional postage. Satisfaction or money back. Allow 30 days delivery for Part Two.

STOP AN ATTACK INSTANTLY!



WITH CHEMICAL SHIELD NON-LETHAL WEAPONS

- Contains the most effective chemical repellent on the market.
- Completely incapacitates one or a number of attackers.
- Contains an ultraviolet light sensitive dye for police suspect identification.
- Made of the finest aerosol hardware components available.
- Genuine suede or leather holsters.

DEALERS AND DISTRIBUTORS WANTED!

- Enter this mushrooming business with the leader and founder of the industry.
- Offering the finest and most extensive product lines.
- Adding exotic products, new to the marketplace, every 6 months.
- Dynamic marketing program includes selling aids and leads for both direct and conventional marketing.
- Work at your own convenience and save tax dollars!

PRODUCTS SHOWN
1/3 ACTUAL SIZE



Weapons Corporation of America
P.O. Box 681
Marietta, Georgia 30061

404-427-8018



Gentlemen,

I am interested in earning additional income, saving tax dollars, and protecting my family, friends and neighbors. Please rush details to:

NAME _____

ADDRESS _____

CITY _____ STATE _____ ZIP _____

P.S. I need immediate protection. Please send me _____ Professional models at \$14.95 each and/or _____ Pocket Shields at \$9.95 each and/or _____ Mini Shields at \$9.95 each and/or _____ Midi Shields at \$12.95 each, postpaid. I understand that if I later become a resale dealer that my retail purchase amount will be applied against my wholesale order.



January/78

Vol. 3, No. 1

SOLDIER of FORTUNE

The Journal of Professional Adventurers



TABLE OF CONTENTS

Full Auto	Chuck Taylor	8
Flak		10
Steele on Knives	David Steele	14
In Review		16
Bulletin Board		18
Terrain & Situation	Jerry Ahern	20
Africa Is Burning	Al J. Venter	22
And They Were the Pros? A Professional Soldier Evaluates CIA/Cuban Exile Operations	Bradley Ayers	28
Free-Lancing in Cambodia: Low Pay/High Risk	Daryl Tucker	31
Silent Death in Vietnam	LTC Robert Brown	37
The New Sidewinder: Tomorrow's SMG Today	Chuck Taylor	43
Great Expectations—the AR-10	Terry Edwards	48
Blackjacks and Billies	David Steele	53
Sentry Removal	Art Gitlin & Mike Echanis	56
Home Drying Journey Food: For Mercs & SOFers on the Road and in the Bush	Edward Brown	58



EDITOR/PUBLISHER
Lt. Col. Robert K. Brown

ASSOCIATE EDITORS

M.L. Jones
Major G.C. Nonte
Thomas McGregor
N.E. MacDougald

CONTRIBUTING EDITORS

Combat Pistol Craft
Lt. Col. J. Cooper

Automatic Weapons
Chuck Taylor

Martial Arts

Art Gitlin

Mike Echanis

Handguns/Handgun Hunting

Lee E. Jurras

Military Affairs

Alexander McColl

Guns

Major G.C. Nonte

Sniping/Counter-Sniping

Capt. J. Leatherwood

Paramedic Operations

Dr. John Peters

Knives/Police Weaponry

David Steele

Terrorism/Latin America

Jay Mallin

Africa

Al J. Venter

Survival

N.E. MacDougald

Aviation

Rocky Kemp

Walt Darran

Dana Drenkowski

Special Weapons and Tactics

Ludwig Nicholas Ladas II

Robert Allman

Explosives/Demolition

John Donovan

EXECUTIVE CO-ORDINATOR

Thomas D. Reisinger

BUSINESS MANAGER

MaryJane Webb

ADVERTISING DIRECTOR

Wm. Garey

ART DIRECTOR

L.J. Mulligan

SUBSCRIPTION MANAGER

Kristi Tamm

STAFF CHAPLAIN

Father Douglas D. Hodges

SOLDIER OF FORTUNE is published by Omega Group Ltd., 1728 1/2 28th Street, Boulder, Colorado 80306. (303) 449-3750. CONTRIBUTORS: submitting manuscripts, photos or drawings, do so at own risk. Include return postage. Second Class Postage is paid at Boulder, Colorado 80302 and additional mailing offices. Copyright 1977/78 by Omega Groups, Ltd. All rights reserved.

**PALADIN
PRESS**



NEW EXCITING TITLES!

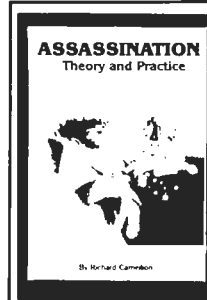

**Assassination,
Theory and
Practice**
by Richard Camellion
"The inside story on
the history of assas-
sinations, including
Russian, German
and our own — plus
sections on the
weapons, methods
and politics."

\$6.00

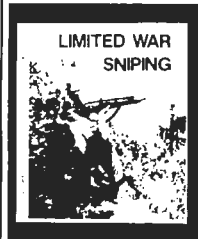

**Limited War
Sniping**
By Peter R. Senich
"The first detailed
history of modern
sniping techniques
and weaponry."
Available December
First.
Clothbound \$15.95

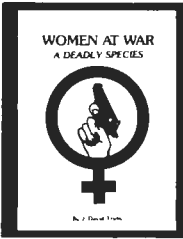

Women At War
by J. David Truby
"Women as soldiers?
Some say go, some
say no!" Many rare
photos.

\$4.00

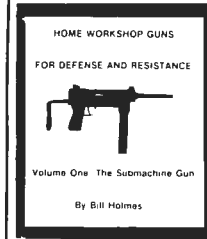

**Home Workshop
Guns for Defense
and Resistance,
Vol. 1, The
Submachine Gun**
by Bill Holmes
"So you'll be
ready..."

\$6.00

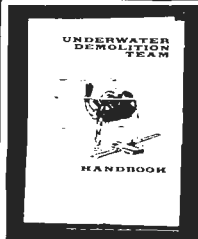

**Underwater
Demolition Team
Handbook**
"Once again avail-
able, the formerly
restricted Navy
'bible' for frogmen
and SEALs."

\$9.95



Kill or Get Killed
by Col. Rex Applegate
"The classic text on
close combat, com-
bat shooting and riot
control."

clothbound \$15.95



Below the Belt
by Bradley Steiner
"The first book that
deals effectively with
rape defense."
Many photos,

clothbound \$9.95

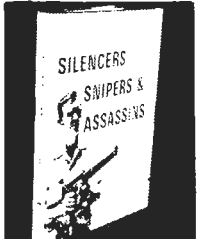

**Silencers, Snipers
and Assassins**
by J. David Truby
"The shadowy world
of intrigue and
silent death fully
revealed at last."

clothbound \$15.95

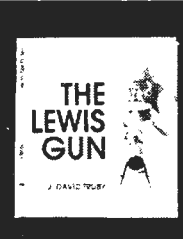

The Lewis Gun
by J. David Truby
"Unusual combat
photos depict over
40 years of land, sea
and air warfare."

clothbound \$25.00

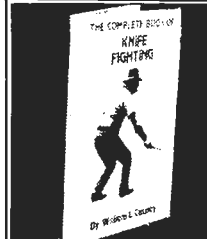

**The Complete
Book of Knife
Fighting**
by William L. Cassidy
"The only book in
print written on this
deadly subject in
the last 20 years!"

clothbound \$10.95

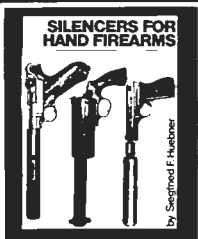

**Silencers For
Hand Firearms**
by Siegfried F. Huebner
"Comprehensive
techniques, draw-
ings and photo-
graphs compiled
from secret
sources."

clothbound \$9.95

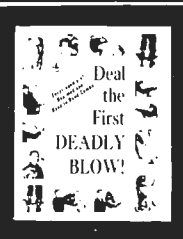

**Deal the First
Deadly Blow**
"Newest available
edition of this ency-
clopedia of unarmed
and hand-to-hand
combat."
New lower
price

\$9.95

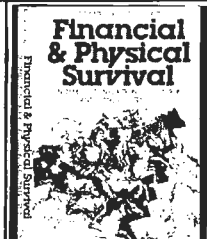

**Financial and
Physical Survival**
by Deane E.
Kogelschatz
"This book may not
only save you
money, it may save
your life."

clothbound \$9.95

OTHER TITLES OF INTEREST

- Ranger Handbook \$ 5.00
- Handbook on Anti-Mau Mau Operations \$ 8.00
- Mechanics of Subversion \$10.00
- Physical Security, FM 19-30 \$ 7.00
- Medical Advisor's Handbook \$ 6.00
- Survival, (Airforce Manual 64-5) \$ 4.00
- Small Arms Ammunition
Identification Guide \$ 6.00
- U.S. Army Sniper Training Manual \$ 8.95
- Special Forces Combat
Firing Techniques clothbound \$12.95

DEALER INQUIRIES INVITED



PALADIN PRESS
P.O. Box 1307 — SS
Boulder, Colo. 80302

ORDER NOW!

Please Rush Me The Following Titles:

Send \$1.00 for the Fascinating
NEW PALADIN CATALOG

NAME _____
ADDRESS _____
CITY _____ STATE _____ ZIP _____

Please include \$1.00 per order for postage and handling charge.

PALADIN

ARMED FORCES
JOURNAL
INTERNATIONAL



INVITES YOU TO
SUBSCRIBE

Why We're UNIQUE

- The independent defense monthly
- Covering timely issues, and issues that are timeless
- Written for senior leaders of the Armed Forces, defense industry, and decision-makers in Congress and the private sector;
- A magazine which is as likely to prod its friends in Defense and the Services as to pat them on the back, because
- It is free of any association or industry affiliations or allegiances.

SATISFACTION GUARANTEED

if not completely satisfied, we will refund your money.

MAIL YOUR ORDER—DO IT TODAY

PLEASE PLACE MY ORDER FOR:

- \$12.00, 1-yr. subscription
- \$19.80, 2-yr. subscription
- \$25.80, 3-yr. subscription

I enclose \$ _____

Print name _____

Address _____

City _____

State _____

ZIP _____

Mail To: Armed Forces Journal, Dept S
1414-22d St., NW, Washington, DC 20037

FULL AUTO

ECONOMICAL CAR-15
and XM-177E2 Conversions for
AR-15/M-16A1 Now Available

During the time I was stationed in Southeast Asia, the M-16A1 rifle was getting to be quite prolific. The U.S. Army was already fully equipped with '16s, the Marines were in the process of swapping their M14s for them and the ARVN's (Army of the Republic of South Vietnam . . . now defunct!) were beginning to receive the M-16.

While it's no secret that I am a critic of the M-16, primarily because I do not feel that the 5.56mm/.223 is adequate for reliable combat use, I do recognize the fact that it is a very prolific weapon/caliber, both in military and civilian circles. Millions of M-16s, and their civilian-legal counterpart, the AR-15, can be found from the jungles of Zaire to the shores of Japan. Therefore, in view of the M-16/5.56mm's availability and almost universal recognition, one would be well advised to have one in his battery of "business" weapons. Though I prefer the AR-10, FN/FAL, CETME (G-3), or M-14 as a battle rifle over the M-16, I must admit that I do have one in my battery and periodically train with it to maintain my skill levels, as do I with my other weapons.

Under certain circumstances, i.e. terrain, vegetation, or vehicular use, the battle rifle, including the M-16, is unsuitable because of its bulk. In such situations a weapon of smaller size and/or weight is more appropriate. If you have a choice of weapons, you are in good shape; however, in combat this is generally not the case and one must choose the most suitable weapon he can find from the spectrum he has available.



Many claim that they prefer a sawed-off shotgun or pistol under such circumstances, but I submit that a shortened version of whatever weapons-system is standard in your area of operations might well be the most suitable answer to the problem. As an example, if the FN/FAL or G-3 is the issue weapon in your area, then a folding-stocked para-FAL or SMG version of the G-3 (MP-5/HK-54) would be a more logical choice. You will avoid the problem of unfamiliarity with a newly acquired weapon, since it is essentially the same in operation technique as the battle rifle model, and, in addition, preclude the problems of parts and ammunition availability that accompany the use of a non-standard weapon in your particular theater of operation.

The U.S. Army's approach to the problem in Vietnam was to adapt the CAR-15, the shorty version of the basic AR-15 system, for specialized use. Thus the SM-177E2 was born, with a telescoping buttstock that reduced the overall length of the '16 four inches, a 12-inch barrel with short handguards that further reduced the weapon's length another 11 inches, and a four-inch long flash/sound suppressor to make it bearable to shoot, since it fired a full-powered high-intensity rifle cartridge!

The "XM" (or CAR-15 which it continued to be called by many) served its intended mission as a compact, lightweight, special-purpose weapon even though it was handicapped by the fact that, although the U.S. Army erroneously classified it as a SMG, it fired the full-powered 5.56mm service cartridge which

(continued on page 72)

XM177E2/CAR-15 SMG

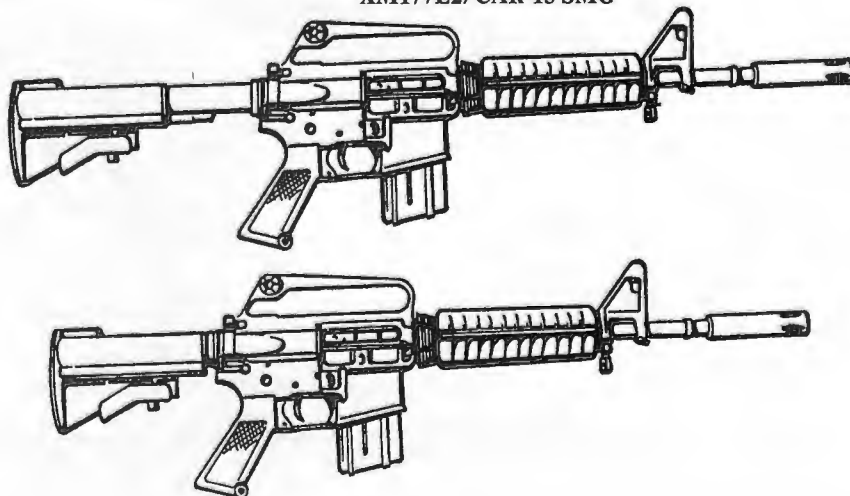

BUY DIRECT AND SAVE MONEY



"ADVENTURER'S" CAMOUFLAGE JACKET

Brand new foreign government surplus. Pullover style with epaulets on shoulders. Features 2 roomy breast pockets and 2 big waist pockets. Rugged 100% cotton. Great for hunters. Sizes: S, M, L. Only \$9.95 plus \$1.50 shipping.



BRITISH COMMANDO BATTLE JACKET

This attractive jacket is brand new British government surplus. A rugged, all-purpose jacket made of O.D. color, heavy-duty denim. It features epaulets on shoulders, 2 roomy breast pockets with flaps and an adjustable belted waist. Ideal for Spring, Summer or Fall. May never be available again! Sizes: XS, S, M, L. Only \$9.95 plus \$1.50 shipping. Please send height, chest and waist measurements for an exact fit.

BRAND NEW, FACTORY FRESH, COMBAT & TARGET MAGAZINES

- Colt .45 Auto, all models: 7-shot \$4.00
 - Colt Commander 9mm, Standard \$7.50
 - Colt Commander, .38 Super, \$7.50
 - Browning High-Power 9mm 13-shot . . \$12.00
 - German Luger 9mm, Standard \$7.50
 - Walther PPK .380 cal., Standard \$7.50
 - Walther PPKS .380 w/fingerrest . . . \$8.50
 - Colt M-16 & AR-15, 30 rd. G.I. . . . \$6.95
 - G.I. Nylon M-16 Magazine Pouch - (holds 3-.30 rd. mags.) \$5.95
 - Colt M-16 & AR-15, 20-rd. G.I. . . . \$3.95
- (Add 50¢ per magazine for shipping.)



NEW PARATROOPER FOLDING STOCKS

for the M-1 Carbine and the Ruger 10/22! Walnut with blued ordnance steel. ready to install. \$37.95 plus \$2.00 shipping. (Specify M-1 Carbine or Ruger 10/22)



New! Rare!

Quick-Release Vietnam Issue Pistol Belt. . . . \$4.95 plus 75¢ shipping.

SPECIAL SALE! "THE LITTLE BLACK BOX"



Warning! This device is not to be used for surveillance! Automatically starts recorder when telephone is picked up. Records entire telephone conversation . . . Then automatically stops recorder when telephone is hung up! Can be attached anywhere along the line. If you want to record both sides of any telephone conversation AUTOMATICALLY whenever a call comes in, this unit is for you. This amazing device plugs into ANY cassette or reel-to-reel recorder and causes absolutely no interference or noise on the phone. Extremely useful around the home or office for making ACCURATE and PERMANENT records of all incoming and outgoing calls. MINIATURE! Only 1" x 2" x 3". Now only \$29.95 plus \$1.00 shipping.

NO FFL OR PERMITS REQUIRED TO ORDER ANYTHING FROM THIS AD

- LOW . . . LOW . . . PRICES ON TOP QUALITY MERCHANDISE TO EVERYONE! ● YOU MUST BE SATISFIED WITH EVERY ORDER!
- ORDER WITH CONFIDENCE!

BRAND NEW! MILITARY EQUIPMENT!

1. Genuine British Commando Knife \$12.95
2. M-16/AR-15 Mag. Pouch w/3-30-rd. Mags. \$19.95
3. USAF Flying Jacket MA-1, Fully reversible, O.D. and International Orange. Sizes: S, M, L, XL. \$34.95
4. USAF Pilot's Survival Knife w/leather sheath and sharpening stone . . . \$9.95
5. USMC Combat Knife w/leather sheath, 7" blade, 12" overall . . . \$10.95
6. USMC Stainless Steel Pocket Knife, \$4.95
7. NEW! Camouflage Duffle Bag, regulation size: 21" x 36", . . . \$8.95
8. Nylon Parachute Cord, 100', . . . \$2.95
9. G.I.O.D. "T" Shirts, Sizes: S, M, L, XL, 6 of same size for . . . \$12.00
10. Genuine G.I.O.D. "T" Shirts w/Original U.S. Marine Corps Emblem or U.S. Army Emblem - (please specify). Sizes: S, M, L, XL. . . . \$4.95
11. G.I. Plastic Canteen, O.D. . . . \$1.95
12. G.I. Current issue Nylon Canteen Cover \$2.95
13. M-1 Carbine Mag. Pouch w/2-15 rd. mags. \$3.00
14. Genuine G.I. M-1949 Mountain Sleeping Bag, the finest available at any price. 50% feather filled/50% down, mummy style, over 6-1/2' long. . . . \$49.95
15. G.I. Jungle 1st Aid Kit, all emergency items in O.D. case that fits on pistol belt. . . . \$3.95
16. G.I. Flashlight w/extra bulb & lens filter, O.D. . . . \$4.95
17. Genuine U.S. Army Short Sleeve Chino Shirt w/epaulets. Khaki Color. Sizes: S, M, L, XL. . . . Only \$6.95
18. G.I.O.D. Nylon Poncho, 66" x 80" \$12.95
19. G.I. Pineapple Grenade w/detachable lever & pin (Inert). . . . \$6.95
20. .45 Auto Clip Pouch w/2 G.I. .45 auto mags. . . . \$8.95
21. MP Nightstick w/leather thong. . . \$3.95
22. U.S. Coast Guard Issue Survival Pocket Knife \$9.95
23. MP Peerless Handcuffs, . . . \$14.95
24. Leather MP cuff case . . . \$5.95
25. G.I. D3-A Glove Shells, Black leather, pair. . . . \$7.95
26. G.I. wool glove liners, O.D., pair . \$2.95
27. Genuine U.S. Army Blankets, 100% wool O.D. in color, Size 66" x 84" \$12.95
28. Vietnam Jungle Hat, O.D., or Camo. Sizes: S, M, L, XL. . . \$4.95
29. G.I. M-65 Field Jackets, complete w/hood. Newest issue. Sizes: S, M, L, XL Olive Drab . . . \$34.95
- Desert Tan . . . Post Paid . . . \$37.95
30. G.I. M-65 Field Jacket Liners, Sizes: S, M, L, XL . . . \$14.95

Do not confuse these genuine items with cheap, inferior imports offered elsewhere. All items — Brand New (ADD 75¢ shipping per each item ordered)

"THE BLACK BOOK OF DIRTY TRICKS"

"Improvised Munitions Handbook", is the most sought-after, here-to-fore impossible to obtain Army manual. Includes revealing chapters on: Improvised Explosives and Propellants; Mines & Grenades; Small Arms Weapons & Ammo; Mortars & Rockets; Incendiary Devices, Fuses, Ignition & Delay Mechanisms. Plus how to manufacture Rocket Launchers, Pistols, Shotguns, and Recoiless Rifles from easy to obtain materials and much, much more! Limited Number Available!
ORDER NOW! — \$10.00 postpaid

BRAND NEW M-1 CARBINE ACCESSORIES

- 5-Shot Magazine \$1.50
 - 15-Shot Magazine \$1.75
 - 30-Shot Magazine \$3.00
 - 60-Rd. Jungle Clip — (Clips 2 30-rd. mags. together) . . . \$2.95
 - Sling & Oiler \$1.95
 - Mag Pouch - holds 2 15-rd. mags. . . \$1.50
 - Mag Pouch - holds 2 30-rd. mags. . . \$4.95
 - Flash Hider. . . . \$9.95
 - Muzzle Brake \$9.95
 - Lo-Profile Handguard \$2.95
 - Ventilated Steel Handguard . . . \$3.95
 - Piston Nut Wrench - (Double-ended) . \$2.95
 - Scope Base, no drilling or tapping . . \$9.95
 - Carbines, Cal. 30 Technical Manual . . \$5.95
- (Please add 50¢ per item for shipping.)

8 SHOT TEAR GAS REVOLVER

With crime on the rise, this is a must for everyone! Fires 8 - .22 cal. tear gas cartridges or blanks in seconds. Heavy-duty metal construction with one-step ejection. Checkered grips. BLUE — Reg. Price \$11.95 Now Only — \$6.95 CHROME — Reg. Price \$12.95 Now Only — \$7.95 Hip Holster \$1.50 Tear Gas Cartridges-(10 per pack) . . \$1.50 Extra-Loud Blanks-(100 per pack) . . \$2.50 (Add \$1.00 per order for shipping.)



U.S. ORIGINAL G.I. .45 AUTO HOLSTER

This is the standard G.I. holster used in both World Wars. Fits .45 auto and other large frame autos. Black leather. \$11.95 plus \$1.00 shipping.



ORIGINAL G.I. M.7 SHOULDER HOLSTER

Black leather, fits 45 Auto. and other large frame Autos . . . \$14.95

W.W. I KNUCKLE KNIFE

Exact reproduction. brass handle 6" blade. Truly a collector's item. Check local laws before ordering. \$14.95 plus \$1.50 shipping.



"PARALYZER" TEAR GAS WEAPON

The most powerful CS* Military Tear Gas available. You simply point the "Paralyzer" at the attacker and press the fire button. A heavy shotgun spray of tear gas shoots out to a range up to 18 feet, completely disabling the assailant for 10-15 minutes. Causes a tremendous burning sensation to the eyes, nose and throat and skin. "Paralyzer" will stop even a 300 lb. man.

POCKET MODEL — \$4.95, POLICE MODEL — \$6.95 + \$1.00 shipping.

PLEASE NOTE: We usually ship 95% of our orders within 10 days. Money orders and cert. checks shipped first; personal checks held 3-4 wks. But because of the unique service we provide and the new law requiring us to state specific delivery times, which in some cases we cannot do . . . we can only accept orders with the buyers understanding of an unspecified delivery date and the buyers waiver of an exact delivery notification. We will advise you on any backordered items and will refund you immediately upon your request. Thank You. Add 40¢ per order for insurance to avoid postal thefts. Ill. res. add 5% sales tax.

ORDER TODAY! American Colonial Armament, Inc. Dept. S1, P.O. Box F Chicago Ridge, Ill. 60415 - Phone (312) 598-4466

FOR YOUR CONVENIENCE
Please charge to my BankAmericard No.
Master Charge No.
Exp. Date _____
Signature _____

U. S. Military Knives

Brand new! Made for the U.S. Armed Forces — not foreign copies. Satisfaction or your money back.



Marine Corps Combat Knife: The blade is parkerized; the handle and sheath are treated with preservative to prevent fungus, rot, etc. This combat knife has a 7" blade so strong that 3/4" of it can be clamped in a vise, and a 185 lb. man can sit on the handle without breaking the tip. Order No. 5684. \$11.95 each.



Air Force Survival Knife: 5" saw-backed blade of tough parkerized steel, leather handle and hammer butt. Metal-tipped sheath with lanyard and sharpening stone. Order No. OKP-1. \$10.50 each.



U.S. Army Machete: Right out of the factory wrap. Made by Ontario for the U.S. Army, the parkerized blade measures 18". Marked with the manufacturer's name and the letters "U.S.". Order No. OKM-1. \$6.50 each.

G.I. Utility Pocketknife



Stainless and with 1000 uses. Ask any boy. Order No. 1760. \$5.95 each.

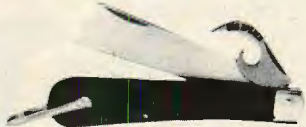

Coast Guard Knife: Current Issue No. 160.043/1/0. Blunt-tipped 3-1/8" blade (just like the old style Coast Guard jack-knives), can opener, shackle and original issue 6' lanyard. Order No. CUT-160. \$9.50 each.

COMMANDO!

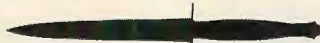

Limited supply from British Military contract overrun. NATO contract number stamped on the guard. These brand new knives are the genuine, original British Commando pattern designed by the famous Captain Fairbairn. Comes with original metal tipped sheaths. Order No. CDO-1. \$16.95 each.

Norwegian Laminated Steel



Finished 4" hunting knife blade, suitable for slicing and skinning. Designed for flexibility — razor blade hard center couched in two softer layers of steel. Just waiting for you to design the rest. Order No. N-10. \$3.50 each. No. N-11, 4 1/2" blade. \$4.00 ea., No. N-15, 6" blade, \$5.00.

We ship your order same day received.

*Please add \$1.00 per order
for shipping and insurance.*

Atlanta Cutlery Corporation

Box 33266 • Decatur, Ga. 30033

Order anytime — (404) 636-7556

FLAK

AIR AMERICA VET WRITES . . .

Dear Sir:

Regarding your questions about Air America. By the time I got interested in them (around 1965-66), they had pretty well gotten out of the really spooky stuff that they were supposed to have done prior to the U.S. military buildup in SEA. I was in the Navy at the time, flying AD "Skyraiders." I sent them several letters and went to Taipei on my own to see them. They weren't encouraging. I had heard rumors that years before, they had arranged "early outs" for pilots who wanted to join, but that wasn't the case when I talked with them. By then, their main mission was the logistical movement of people and supplies, the "hard rice" delivery taken over by USN/USAF. Of course, there were many enthusiastic pilots that volunteered such personal efforts as dropping grenades on unfriendly grunts, etc., but those games were officially frowned upon, mainly because Air America and Continental Air Service were nominally in business to make a buck, and most of the birds we lost (at that time) were due to such shenanigans.

Anyway, Air America said to keep in touch and when I finally said I had a firm release date from the Navy, they hired me on the spot. I flew for then for 8 months in Udorn before quitting to go to work for Continental in Vientiane (quicker check-outs and better pay).

As you're aware, there were a lot of heroics, but most of them had to do with defending buddies or friendly forces, as best we could with unarmed birds — attempting pickups or acting as a diversion. We weren't supposed to, but most of the guys carried weapons, more as an ego boost than anything, since few of us had any training as grunts. Probably the only result of an active defense would have been to piss off the other guys.

There were some interesting exceptions, however, such as when a couple of Russian-made "COLT" biplanes attacked a nominally secret Tacan site in Northern Laos. A civilian version of the Huey was just lifting off their helipad as the Russkies started depositing bombs

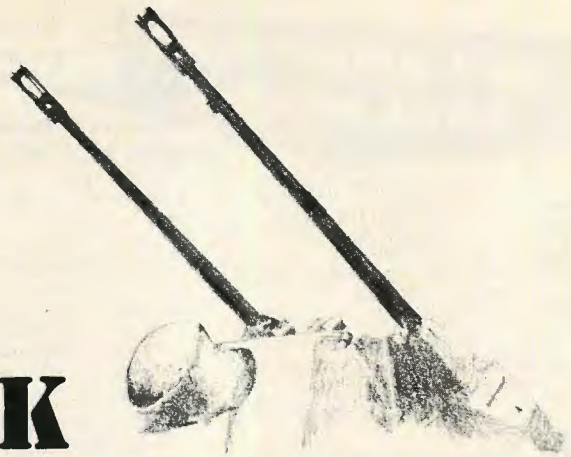

and rockets on the site. The guys on the ground shot down one of the attackers with small arms. Then, the helo pilot suddenly discovered he could outrun the Colt. Being a typically dingy AAM pilot, and seeing as his crewchief was carrying an AK-47, he gave chase and caught the Colt. After a few passes — zap! the enclosed swatch is a piece of the wing of the only fixed-wing ever downed by a chopper. That story was written up in the Bangkok Post but to my knowledge never made the U.S. papers.

W.D.

Pocatello, ID

Let's hear from more of you Air American types, so we can give credit where credit is due!

PMRS SUPPORTER . . .

Dear Sirs:

I just finished reading the letter to Bob Brown in the Spring edition of S.O.F. from Skip Cheal down in sunny Honduras. I had read the article "Honduras Jump" and could relate to the conditions that he and the other PMRS members encountered during that mission. The idea of the PMRS is, in itself, commendable; however, Skip's decision to return to Honduras and continue helping the people is the kind of thing that keeps my head on straight each day. In this upside-down negative world, I believe you can understand my statement.

When I first read S.O.F., I found it informative and somewhat unique. As a city cop who has spent 15 years on the bricks, I could relate to the "shoot first, ask questions later" format. Much of the hardware and security procedures exhibited were relevant to my profession. I have been involved in the department's bomb disposal team, S.W.A.T. and sniper counter-sniper activities and other fun and games. Your publication is a valuable addition to the man on the line. It is also worth noting that your magazine offers professional police officers a vehicle to further express skills and training.

But let me say, that what really turned me on are the Ops of the PMRS. The article on Guatemala by Dr. John Peters was of special interest to me. I was a member of an "expedition" to Guate-

'IT MUST BE TRUE, I READ IT IN THE PAPER'

Remember when you could settle an argument just by quoting the newspaper? It doesn't seem to have the ring of authority it once had, does it?

Or remember when the editorial page was the **only** place where editors expressed their views and opinions? Nowadays it seems one-sided editorializing runs through the entire paper.

HERE AT LAST The Newspaper You Can Trust

Now there's a newspaper that digs for the truth . . . a paper you can rely on for the facts. If you're looking for behind-the-scenes coverage of today's headline stories, you'll find The SPOTLIGHT on target every week.

The SPOTLIGHT is written for the consumers, taxpayers and voters who realize that something is radically wrong with America . . . and are fed up with platitudes from political leaders and coverups from the liberal press.

Recent issues of The SPOTLIGHT alerted readers to these inside reports:

- **How Your Taxes Support Illegal Aliens**
- **Use of Cocaine plant in Processing Coca-Cola**
- **Justice Dept. Covers Up Mafia Murder on Capitol Hill**
- **Media Ignores Adverse Effects of "Pot"**
- **Prostitution Scheme Exposes Union Corruption**

- **Drug Industry Distorts Laetrile Tests**
- **Coffee Price Increase Spurred on by State Department**
- **Election Finance Law Viewed as Fraud**
- **Sex Deviates Exploit "Human Rights" Issue**
- **How the Israeli Lobby Manipulates Congress**
- **Carter Fakes Oil Gap**
- **How Tax Rebels Don't Pay**
- **U.S. Moving Toward One-World Government?**
- **Panama Canal Giveaway Serves Goal of Soviet Navy**
- **New Facts About the Mysterious Bilderbergers**
- **Instant Registration Bill Would Raise "Born Again" Voters**
- **U.S. Violates UN Drug Treaty**
- **Urban Renewal—Nation's Biggest Graft**
- **Why the Grim Truth On South Korea Was Covered Up**
- **How Congress Sneaked a Pay Raise For Themselves**
- **Universal Price Code Stalled at Checkout Counter**
- **How Nader's Consumer Campaigns Cost You \$\$**
- **Methods Used by Bureaucrats to Snoop Trap and Smear**
- **How Carter Used the Bureaucracy to Axe Critics**

This is just a sampling of the **exclusive** news and features you'll find in every issue of The SPOTLIGHT.

Subscribe today and see for yourself what you're missing.

YOUR WEEKLY NEWSPAPER FROM WASHINGTON



To: The SPOTLIGHT 300 Independence Ave., S.E. Washington, D.C. 20003

Dear Sirs: Please send me _____ subscriptions to SPOTLIGHT as indicated below.

(Please list additional names and addresses for gift subscriptions on a separate sheet of paper and attach.)

20 weeks at \$4.95 52 weeks at \$12.00

Name _____

Address _____

City _____ State _____ Zip _____

Your first issue will arrive in about three weeks—watch for it!

mala a short time before the disastrous earthquake. We spent time in the mountains, eating and sleeping in the same crude conditions as the people. We stayed a few days with a Peace Corp volunteer, in the small village of San Lucas Toliman and observed his work. We then walked, rode in jeeps and trucks all over the south/central mountain regions of that most beautiful Latin land. It was my first introduction to the people of Central America and to abject poverty, malnutrition and hopelessness. It made quite an impression on me and I will never forget it. After reading of the Guatemala operation by the PMRS, I wish now I could have gone in with them. If I had the training and flexibility to do so, I would jump in a minute.

I might point out at this time, for any of your readers who are so locked into the "kill for thrill/die in a whorehouse" mentality, that every mission has an objective. And above all, remind them that if you have won the people, you have won the war.

Officer K.B.
Toledo Police Department
Toledo, Oh

FROM THE DISTAFF SIDE . . .

Dear Sir:

As politicians attempt to maintain the status quo, with our freedom as the expendable commodity, I would appreciate

the opportunity to say something through your magazine.

As an American woman, I appreciate the freedom American fighting men have bought for me. Men who have killed the enemy in hand-to-hand combat, who have lain in muddy swamps on traditionally emotional holidays, who have concentrated on killing the enemy over the infinite number of things that can distract the soul . . . they pay the real price of national freedom. I don't understand all such men have done, because they did it. I couldn't. But I can appreciate it and respect it, and would appreciate the privilege of expressing this to such rare men in a nation of abundant boys." A number of them may read S.O.F., so that's why I wrote you.

Mary Ann
Bryan, TX
P.S. It's refreshing to read your magazine.

MORE ON PETROGUARD . . .

Dear Colonel Brown:

As a handwriting analyst, I was immediately drawn to the "chicken scratching" of a supposed "D.C. Dungan, Col. (Ret.)" that accompanied the Petroguard, Limited, letter on page 38 of the September 1977 issue of SOF.

Even without having read the material or knowing just what the score was, my first reaction upon examining the signa-

ture was, "Man, I wouldn't trust that character as far as I could throw him!"

The predominant feature of the signature is its illegibility. One who signs his name in this manner does not really want the world to know him too well. He may have something to hide, or he may not really care what others think about him, or whether or not they understand him. When a signature is so complicated or involved that it isn't legible, one may be certain that the writer has an involved and complicated personality.

A candid, open, aboveboard individual has nothing to conceal, and will thus write in a plainly legible manner, as he wants to be understood.

One's signature is his individual stamp, and reveals what one thinks of himself and also how he desires to appear to the world, whether a plain, uncomplicated person or an ostentatious egotist.

The signature of the only commanding officer in naval history to surrender his command without a show of force also reflects this illegibility, along with a circle enclosing the signature, indicative of a protective nature that shuns responsibility, and is only concerned with his own comfort, safety, and hopeful safe retirement.

I feel that SOF is packed with good stuff. Keep up the good works. Were I younger, I'd hightail it for Rhodesia in a minute, but am nearing 70 and retired on

(continued on page 68)

NEW

FROM IMPOSSIBLE ELECTRONICS

MOST ADVANCED NIGHTSCOPE/ WEAPONSIGHT IN THE WORLD TODAY



- totally anti-blooming
- 80,000/1 ~ minimum gain
- totally passive & covert
- high performance optics
catadioptric & refractive
- high resolution
- weaponsight models,
externally adjusted
reticle for rigid mounting
to any weapon

**IMPOSSIBLE ELECTRONIC
TECHNIQUES, INC.**

BOX 232 WAYNE PA. 19087
(215) 687-5400 TWX: 510-668-2373
CABLE: IMPOSSIBLE ADRP

Without a doubt the world's most advanced technical library of sophisticated fire-power available today!

SPECIAL WEAPONS



... and there's a lot more! We've got an unbelievable collection of some really great, never before published, advanced, technical studies.



**MILITARY - HUNTING - AMMUNITIONS
CHEMISTRY FORMULAS - FIREARMS
SCIENCE - LASERS - SPY ELECTRONICS
SPECIAL LOCKS - ENERGY - DEFENSE
WEAPONS - EXPLOSIVES**



SEND FOR OUR ILLUSTRATED 150 PAGE CATALOG \$1.00

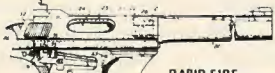

RAPID FIRE AUTOMATIC WEAPONS

Thorough introduction into the principles and operation of the latest special automatic weapons. FIRING MECHANISMS, EXTRACTOR DESIGNS AND DOUBLE ACTION HANDGUNS reveals what information is on file. Brand new and richly illustrated reference guide. For the one who seeks to extend his knowledge and skills.

78 PAGES - 117 ILLUSTRATIONS. . . . \$4.75

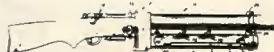

HOME DEFENSE WEAPONS - NON-LETHAL

An up to date account on the latest in weapon technology. This classic work, incorporates RIOT CONTROL WEAPONS, GOLF BALL and RUBBER BULLET PROJECTILES, VEHICLE THEFT and ROBBERY DETERRENTS. Highly readable and concise. You will enjoy a fantastic journey through this wide ranging collection. Crime, rape and assault are on the rise! You have a legal right to protect yourself and loved ones.

75 PAGES - 125 ILLUSTRATIONS. . . . \$4.50



THE MUZZLE BREAK HANDBOOK

An up to date account, complete in every aspect on how to counteract muzzle recoil. STABILIZERS, ANTI-CLIMB DEVICES, & NUMEROUS CONTROL SYSTEMS will be truly indispensable knowledge for the hunter or marksman. Probably the best book ever done. Explains in full illustration, every trick of the trade.

105 PAGES - 146 ILLUSTRATIONS. . . . \$6.25

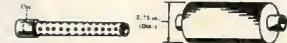

TECHNICAL SILENCER REPORT

Informative, technical data and drawings on the operating principles of handgun and rifle silencers. Modern, complete, detailed construction plans for the amateur and gunsmith alike. Theory and simplified drawings provide a convenient basis for reference. A precisely documented account, thoroughly reviewing all fundamental skills and knowledge.

DESCRIPTIVE METHODS AND TECHNIQUES. . . . \$2.00



TELESCOPIC SIGHTS

To be an expert in a particular field an individual must have every bit of technical information available. Detailed internal and external exploded view drawings will help you understand every aspect in design and construction. ILLUMINATED RETICLE, VARIABLE RANGE SETTINGS, RANGE FINDERS, and COMPENSATING TRAJECTORY SYSTEMS puts you right on target.

74 PAGES - 63 ILLUSTRATIONS. . . . \$4.75

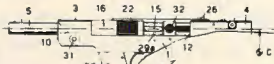

THE MATCHMAKERS

Features for the marksman and experimenter spotlight details and explanations on match-pistol designs. An unusual and stimulating new book presents all the elements needed for the target shooter. ELECTRICALLY FIRED PISTOL, BREACH LOADED LONG-BORE and SELF-LOADING HANDGUN are just some of the stuff you've been looking for.

34 PAGES - 44 ILLUSTRATIONS. . . . \$3.00



COMBAT, ASSAULT AND INFANTRY WEAPONS

A very definitive work, done on a unique subject never before published in such a clear and concise manner. Discusses component parts and closely kept secrets. Does a better job in explanation than most other textbooks on weapons. SUBMACHINE PISTOLS, AUTOMATIC WEAPONS, INFANTRY FIRE PISTOLS, DUAL-MODE RIFLE and a lot of other hot little items that are sure to be fascinating as well as educational.

137 PAGES - 154 ILLUSTRATIONS. . . . \$8.25

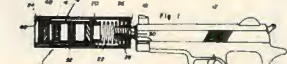

SILENCER CONSTRUCTION GUIDE - PART I

A brand new, richly illustrated guidebook for the serious minded gun enthusiast or hobbyist. It has everything you need; operating theory, detailed drawings, and construction procedures, for twenty of the most popular silencer designs. Don't be fooled by look-alikes. This is the original. Comprehensive in every aspect. Combines new and old techniques.

80 PAGES - 108 ILLUSTRATIONS. . . . \$5.00



HI-SPEED MACHINE GUNS

The military aspect of these weapons and the fire-power they possess, can classify them as the world's most deadly firearms. With a fantastic amount of devastating accuracy, a person with this knowledge can become an expert in sophisticated weaponry. MULTI-BARRELED MACHINE GUNS, SEMI-AUTO and FULL-AUTO, MECHANISMS and COMPACT HI-SPEED MACHINE GUNS, covers every phase of operation and design.

49 PAGES - 58 ILLUSTRATIONS. . . . \$4.00



SPECIALIZED WEAPONS

A brilliant investigation into HYPERVELOCITY RIFLES & PROJECTILES, LIQUID PROPELLANT WEAPONS AND CASELESS AMMUNITION & THEIR FIREARMS, highlights a dynamic book. All the basic techniques and hard to find equipment keep the pace with fast changing designs. Explore these pages and you may very well discover a new world of some really fascinating weaponry.

105 PAGES - 146 ILLUSTRATIONS. . . . \$8.00



HOMEMADE GUNS AND SILENCERS

The world has never seen such a perceptive book. You will be fascinated with the ingenuity in which these weapons are put together. There is no other publication like it on the market today. These guns can be assembled from hardware store materials right in your home workshop. WATER PIPE RIFLES & PISTOLS from .22 - .45 CALIBER WITH HOME-MADE SILENCERS are described in every step of construction.

35 PAGES - 107 ILLUSTRATIONS. . . . \$3.50



SILENCER CONSTRUCTION GUIDE - PART II

A continuing study into the fascinating world of silenced firearms. Nineteen more designs are explained in this exciting back-up publication. Contains some of the newest silencers ever made; thorough and up to date essential information. This could be the one revealing book that can make you an expert on silenced weapons.

77 PAGES - 102 ILLUSTRATIONS. . . . \$5.00

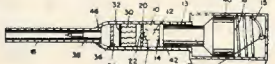

ULTRA-SILENT WEAPONS

A book that is, for sure, to be one of the most interesting additions to your technical library. Compiled from a variety of special devices, SILENT FIREARMS, GUERRILLA WARFARE, SPRING-ACTUATED HAND WEAPONS, HIGH POWERED CROSS BOWS, FINGER KNIFE SLING SHOTS and some HIGH POWERED LASERS should capture your imagination.

69 PAGES - 89 ILLUSTRATIONS. . . . \$4.75

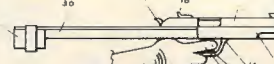

FIREARM IMPROVEMENTS AND MODIFICATIONS

One of our greatest achievements and a penetrating study, which incorporates the latest research in weaponry and hardware. Described for the general reader wanting to learn more about some handy new items. ILLUMINATED and LOW-PROFILE GUNLIGHTS, STABILIZERS FOR HANDGUNS, & BEER CANNJECTOR TARGET SHOOTING only begin to cover a full range of some really extraordinary subjects.

74 PAGES - 101 ILLUSTRATIONS. . . . \$4.50



ROCKET LAUNCHERS AND GRENADE THROWERS

A brand new, very well organized guide to operation covers everything you need to know and is easy to read. The first book that puts it all together in one complete package. The militant enthusiast will be delighted with the materials and how they are explained. AIMING DEVICES, LAUNCH TUBE DESIGNS, and SMOOTHER TARGET PROJECTILES are all here.

42 PAGES - 24 ILLUSTRATIONS. . . . \$3.00



IMPROVED SILENCERS

An effective silencer, for a rifle or handgun, can be put together in an hour or so from parts found at the hardware store. BOTTLECAPS, STEEL WOOL WIRE, PIPE FITTINGS, TAPE and a FEW HANDTOOLS should be just about all you need for a variety of applications and designs. Ideal for the home experimenter.

A CONCISE SUMMARY. . . . \$3.00



THE GREATEST GUNS IN THE WORLD

A superbly researched account covers the origins, specifications and illustrations of some of the most fantastic guns ever invented. Reprinted from actual documents and original drawings, this book will complete your technical library. LUGER, BROWNING, COLT, SMITH, and WESSON and others; these are the names and the guns that made them great.

94 PAGES - 104 ILLUSTRATIONS. . . . \$8.00

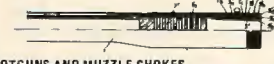

SHOTGUNS AND MUZZLE CHOKES

One of the very few books that tell the beginner exactly what he wants to know. Top sheet of hunting, this covers it all, from the simplest operation to the most complex designs. Offers the most complete definitions; ADJUSTABLE AUTOMATIC CHOKES, ANTI-FOULING DEVICES and SHOT PATTERN CONTROL offer a first hand account in this most remarkable presentation.

116 PAGES - 180 ILLUSTRATIONS. . . . \$7.00



CONCEALED WEAPONS

Ingenuous examples and somewhat unorthodox designs make these two books useful guides for the home experimenter and gunsmith. No effort has been spared in giving the craftsman startling illustrations and accurate, essential information ranging from theory to application. A study into WRIST-GUNS, BELT-BUCKLE FIREARMS and other assorted weapons disguised as CAMERAS, BALL-POINT PENS, FLASHLIGHTS, ROCKET-WATCHES, etc.

PART 1 - 72 PAGES - 98 ILLUSTRATIONS. . . . \$4.50
PART 2 - 80 PAGES - 145 ILLUSTRATIONS. . . . \$5.00

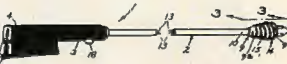

ELECTRIC WEAPONS

The alternative to killing. Self defense weapon systems that can be used to discourage attack by assailants or vicious animals. STUN GUNS, HOME PERIMETER PROTECTION, FENCE CHARGING and TOUCH WEAPONS provide a non-lethal approach to protecting your life and property. Never before published study puts together all of the little known materials available.

64 PAGES - 72 ILLUSTRATIONS. . . . \$5.00

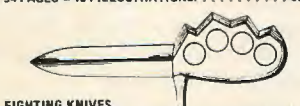

FIGHTING KNIVES

If you enjoy reading about hunting and fighting blade designs as much as we do, you will be fascinated with the illustrations of THROWING DAGGERS, ORNAMENTAL AND SPECIAL HANDLE DESIGNS, COMBAT-HUNTING, and a sharp KNEE-MOUNTED BAYONET really set off this one of a kind addition to your technical library. Sharply illustrated and detailed.

64 PAGES - 208 ILLUSTRATIONS. . . . \$4.25



UNDERWATER WEAPONS

An unusual, stimulating, one of a kind publication; packed full of information on underwater weaponry. GAS GUNS, SHARK DARTS, IMPACT WEAPONS, and UNDERWATER PISTOLS, diving bombs, and other underwater weapons of fire power in a very well organized and put together handbook. Some of the POWER-HEAD designs can be used for personal protection as devastating contact weapons.

78 PAGES - 83 ILLUSTRATIONS. . . . \$5.00

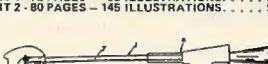

FLAME THROWERS

A subject shrouded with mystique, information and technical data is so scarce, we dare you to find anything quite like this book. SHARPER, MORE EFFECTIVE, and PORTABLE FLAME THROWERS highlight a really hot piece of investigative work. There is much to be learned and we feel this is one of our finest, most devastating books.

81 PAGES - 75 ILLUSTRATIONS. . . . \$5.50



POLICE WEAPONS

Our little does not necessarily reflect the only use for these weapons. They are unique, sophisticated in design and highly detailed. They are the most advanced in their field. Applications including guerrilla warfare and combat - military applications. COMBAT HAND FIRE WEAPONS, CLOSED BREACH-ROCKET GUNS, MACHINE PISTOLS, MUZZLE COMPENSATORS and a HIGH POWERED WATER CANNON should bring you some interesting reading.

82 PAGES - 86 ILLUSTRATIONS. . . . \$5.50

All orders are shipped in 72 hours - 4TH CLASS MAIL TAKES 3 TO 6 WEEKS MAXIMUM FOR DELIVERY. Notify us, not magazine publisher, if you do not receive your books within that time.

FOR FASTER DELIVERY
1ST CLASS POSTAGE, IN THE U.S.A., 75¢ EXTRA PER BOOK.
FOREIGN ORDERS, AIR MAIL-PRINTED MATTER, \$1.50 EXTRA PER BOOK.



AVAILABLE EXCLUSIVELY FROM
CASHIER PUBLICATIONS
INDUSTRIAL 791 DEPT. SF
HILLSIDE, NEW JERSEY 07205 U.S.A.
(201) 686-1818

GERBER MARK II SURVIVAL KNIFE

• **BRAND NEW** Hand-crafted from a special alloy tool steel. Is not chrome-plated and can be blued. Scabbard complete with hanger for regulation web field belts and regular belts. 36" leather thong ties scabbard to leg. Double-edged blade for defense and survival.

ONLY \$37.50 plus 70¢ p&h

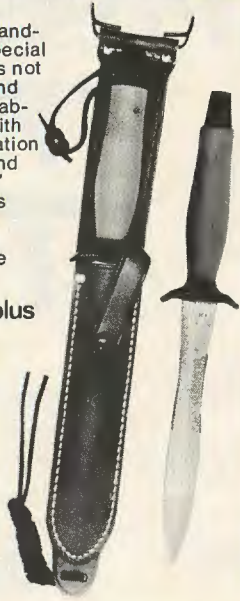

SEND CHECK/MONEY ORDER TO:
PHOENIX ASSOC.
P.O. BOX 693
BOULDER, COLORADO 80306

How'd you like your Buck 110 Folding Hunter to cut like this?



Supersharp will slim down the blade of your Buck for easier resharpening, then we'll finish and polish to a hair-splitting edge and have it back in the mail to you within 5 days. The Supersharp edge is easily restorable by conventional means.

Introductory price: \$5.00 plus \$1 handling.

Send \$1.00 for Illustrated Brochure of special knives, modifications and prices.

Supersharp

Rt. 2, Box 253, Scott, La. 70583

STEELE ON KNIVES



Q. I'm glad to see that you are now doing a column for SOF. It's one of my favorite magazines.

Although the recently liberalized "concealed-carry" law here in Georgia permits almost any law-abiding citizen to carry a concealed firearm, I have always preferred an edged weapon. Besides, with my build (5'7", 200 lb.) it is difficult to unobtrusively carry a 6-inch S&W M-19.

I have been looking at the various commercial folding hunters with an eye to rapid one-hand operation. I have a Gerber Mark 1, but the thought of perhaps ditching a \$35 knife makes my Scots ancestors visit me at night with much rattling of Claymores and Targes.

So I decided on a lock-back folding knife for full time carry. The Gerber Mk. 1 and S&W M-19 are to be held in reserve for any excursions into doubtful territories.

I am now the proud owner of some 12 lock-back folding knives; none cost more than \$25. All are of fairly good to excellent quality, both U.S. and Solingen.

Of all these knives, the one that I have found most suitable for weapon use is the Gerber FS II. Mine has the original swept point blade, and I keep it sharp and lube the pivot with Gunslick.

After a close examination of this knife I have come to think that Al Mar (Gerber's designer) had more than "safety" in mind when he came up with the hesitation notch idea. With the exception of a custom-made "semi-gravity" knife that I saw recently, the Gerber is the easiest of all the folding knives that I have ever examined to operate one-handed. Simply "thumb" the blade out to about 25 degrees, and it springs into the hesitation notch. A simple wrist flick and it is locked open. In order to assure rapid operation under all conditions I added a "Flicker". After a few minutes with a file I reduced the Flicker to just a rounded tab. This prevents excessive wear on my pockets and still provides a bearing surface for my thumb.

After some thought I have come up with an idea. After much sketching of button and lever gravity knives, I decided that "more is less" and turned toward

the simplest concept for a one-hand lock back that I could come up with. Here it is: a pin through the handle of the knife which limits the inward travel of the rocker, and the tang of the blade ground so that the blade will swing freely from 20 degrees to 160 degrees of its 180 degrees travel. A knife made in this manner can still have a strong spring and be easily operated with one hand. As soon as I can find someone who will either modify a production knife or make one at a reasonable price, I'm going to try my idea and see if it works.

R.W., Harlem, Ga.

A. *Your conclusions are sound. I carry a Gerber Folding Sportsman II more than any other knife. It is slender, easily carried, and takes a great edge. It is, as you say, very easy to open one-handed (readers should refer to my book, Secrets of Modern Knife Fighting, for photos of how this is done). It always seems to be the knife I have with me, whether walking the streets of Los Angeles or fishing in the Gulf of Thailand.*

If there is anything that my book added to the literature on knife fighting it was the emphasis on folding knives. The older books, like those by Biddle, Fairbairn, Styers, and Applegate, dealt with the sheath knife exclusively. The sheath knife is the weapon of choice for military combat, where extreme strength is necessary and concealability is not an issue. In street combat, on the other hand, the folder reigns supreme, though the boot knife and belt buckle knife are also quite popular among aficionados.

I have suggested to Pete Gerber and Al Mar that the FS II be produced in a model with a V-point, with grooves along either side of the blade replacing the nail-nick for easier thumbing. Whether they take my suggestions would depend on several factors, not the least of which would be whether local ordinances directed against it might curtail its market.

Q. I have been looking around for a particular item for some time now, and after reading your articles on knives I feel that you may be the one to help me. I am looking for a knife with qualities that I

have been unable to find in any sporting goods stores here in Toronto. These qualities should be:

1. Balanced — suitable for throwing in emergencies.
2. Double-edged blade — keen enough for skinning animals and yet robust enough for general camping use.
3. Fairly heavy.

If it is not possible to purchase a knife such as this, who would I contact (U.S. or Canada) to have one custom-made? I would like to emphasize that this knife would be used strictly for hunting/camping and is not intended for offensive or defensive use against another person.

L.R., Toronto, Ont.

A. Your query presents several problems. In sum, I would have to suggest you buy two, perhaps three, knives to do what you want. First, throwing knives are usually made softer (on the Rockwell C-scale) than hunting knives, in order to resist breakage; they will not hold a hunting edge long. Second, a double-edge blade does not make a good skinner because it tends to slit the game accidentally on the backstroke. Third, a "fairly heavy" knife does not usually "pay its weigh" in the field, adding an excessive burden to the bedraggled hunter.

The best compromise I could think of would be the Bowen Model 114 "Wilderness Knife." This knife has a six-inch 440C blade with solid integral handle, balanced for throwing (in emergencies only). Remember that throwing a knife is not likely to protect you from a man or a dangerous animal, better to throw rocks and save the knife for close combat. Bowen Knife Company's address is Rte. 3, Box 3245A, Blackshear, GA. 31516.

Q. How do you stand on switchblades? I know a friend who bought a 12 inch job in Chicago but refuses to part with it. Are there any states where they are not illegal? Do you know of any other good quick-action folding knives?

M.S., Columbus, Ohio

A. The federal government, under a law passed in 1968, made it illegal to manufacture, import, or transport across state lines any switchblade or gravity knife. Simple possession of them is a matter for local and state ordinances; check with your local D.A.'s office.

There have been some high quality switchblades made in Germany, England, and the United States, perhaps also in Spain and Italy (though I've seen only second-rate examples). However, none of the ones I've come across, including the 6-inch Italian stiletos, are really first rate as fighting knives. They are usually weak in the tang/lockback juncture, possess flat springs which weaken with time, and are made of cheap steel that will not hold an edge. I could not recommend to anyone that he risk a felony charge by carrying a weapon that might fail him in any case.

(continued on page 74)

THE NEW RS-1 SURVIVAL KNIFE:
NOW AT THE INTRODUCTORY PRICE OF \$50. BROCHURE FOR \$1. BROCHURE & SAW—\$3.

NOT JUST ANOTHER KNIFE BUT A TOTAL WILDERNESS SURVIVAL PACKAGE! • SEMI-DROPPED POINT FOLDING KNIFE DESIGNED FOR HEAVY DUTY USE ★
 ★ CONTAINS A 16 INCH RETRACTABLE WIRE SAW
 ★ APPROVED BY THE U.S. MARINES FOR COMBAT AND SURVIVAL USE ★ BLADE IS 1/4 INCH THICK OF 440c STAINLESS, TEMPERED TO ROCKWELL 58-60 ON THE "C" SCALE ★ COMES WITH A HEAVY STITCHED BELT LOOP SHEATH OF BLACK STEERHIDE. SHIPPED IN A 606-T6 ALLOY ALUMINUM TUBE WITH END CAPS FOR STORAGE OF GEAR REQUIRING WATER-PROOF PROTECTION



ORDER THE NEW RS-1 FOLDING SURVIVAL KNIFE WITH WIRE SAW BY SENDING PAYMENT TO **THE REMOTE SURVIVAL COMPANY,** P.O. BOX 523, NEW HAVEN, CONN. 06503

ARE YOU MAN ENOUGH?

for the **Wilber X-1.**

Handcrafted of the finest materials for the discriminating professional, the Wilber X-1 is not to be taken lightly. The Wilber X-1 is clearly a knife for the man that knows what he wants and how to go about getting it. Orders accepted only from qualified professionals. Write or cable for further details and price.



W. C. Wilber, Maker
 400 Lucerne Drive
 Spartanburg, South Carolina 29302

INDISPENSABLE!

Have you seen the FLICKET?

It attaches to single lock-blade knives to give you one handed access to your blade with a flick of your thumb!

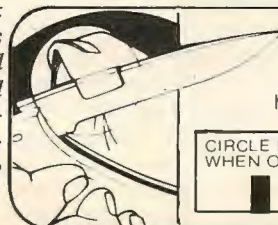

CIRCLE BLADE THICKNESS WHEN ORDERING BY MAIL



ASK YOUR DEALER OR WRITE OR CALL:

C K C. Mfg. Co. • 404-963-3570 **\$295**
 110 Crogan St., Dept SF
 Lawrenceville, Ga., 30245 ea. ppd.

**COMMUNICATIONS
THE VITAL KEY
TO COMMAND!**

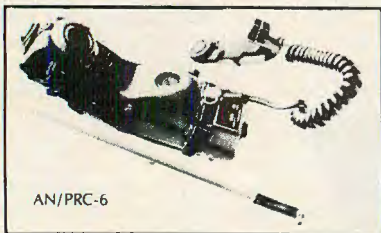

**NOW FOR YOU, SUPERB
COMMUNICATIONS AT A
FRACTION OF GOVT. COST**

This lightweight (Magnesium Alloy Case) FM radio is built to take roughest use, has 2 Km range. Any crystal channel from 47 to 55.4 MHz. Comes complete with auxiliary handset, aerial, carrying strap . . .

USED SURPLUS, \$ 35.00
REM'FG TO GOVT. SPECS \$ 150.00
TESTED SURPLUS BATTERY \$ 7.00

**ALL ITEMS SHIPPED PREPAID; LARGE
PARTS STOCK ALWAYS ON HAND
AN/COM
ELECTRONICS**

**5521 Cleon, No. Hollywood, CA 91601
(213) 769-5518**



RUGGED ORIGINAL

**FALLSCHIRMSPRINGERSTEIFEL
GERMAN PARATROOPER BOOTS**

Now available for custom orders. Prized jump boots for all Airborne personnel. Rugged beyond compare. Smooth black leather with a patented lacing system. Lined with supple calfskin and padded for protection. Closed tongue. Waterproofed. Double-stitched. Non-slip rubber heel and half-sole over leather base. European sizes 39-47 (US 6-12) Narrow, regular & wide. Shortages require 10 weeks delivery. MC, BAC accepted. Phone 404-943-9336 today! U.S.A. & A.P.O. Addresses only. Or send payment to:

BRIGADE QUARTERMASTERS LTD.

P.O. BOX 108-L POWDER SPRINGS, GA., 30073

INTRODUCTORY OFFER.. \$88.95 PPD

IN REVIEW



**THE CARLOS COMPLEX: A STUDY IN
TERROR** by Christopher Dobson and
Ronald Payne. G.P. Putnam & Sons, New
York, 254 pp., \$8.95.

"The Carlos Complex" takes its name from the world's most famous practitioner of international terror but it ventures beyond merely detailing the biography of just one hijacker and kidnapper and provides a lucid, compelling, intelligent and fascinating look at the whole network of global terrorism from Black September to the Japanese Red Army to the West German Baader-Meinhof gang — and the support governments from Moscow to Aden to Tripoli to Havana have provided it.

"Carlos" himself is in reality Ilitch Ramirez Sanchez, the womanizing, slightly pudgy (he was called "El Gordo" — "The Fat One" — long before he became "Carlos") son of a millionaire Venezuelan Communist Party member. He claims to have begun his activist career at the age of 14 in a series of riots that swept Caracas in 1963. Trained in Cuba and bounced out of Moscow's Patrice Lumumba University "for anti-Soviet provocation and leading a dissipated life" (the authors feel the expulsion was a KGB contrivance), he very quickly settled down in Paris and London as a key operative of Wadi Hadad's Popular Front for the Liberation of Palestine.

In London he personally attempted the murder of a prominent Zionist, Teddy Sieff. In Paris he hurled grenades into a crowded drugstore, killing two. He plotted and supplied the Japanese Red Army's seizure of the French embassy at the Hague.

It was Carlos who led the 1975 raid on the Vienna OPEC conference and seized such prominent hostages as Oil Minister Sheik Yamani of Saudi Arabia. It is suspected that he masterminded the Entebbe hijacking of 1976.

Carlos himself is an intriguing figure, tough, brutal, resourceful, but of still greater fascination are the interlocking relationships of today's worldwide terror network. At Vienna and Entebbe many German nationals were involved in a supposedly Palestinian operation. Carlos himself is, of course, South American.

The Japanese Red Army in 1972 committed the bloodiest of PFLP terrorist actions at Tel Aviv's Lod airport. Libya's Colonel Quadafi has funneled arms to the Provisional IRA, Philippine separatists, and Lebanese leftists — and over \$30 million to El Fatah.

An Iraqi diplomat sent to mediate at Vienna was puzzled to find that while the operation was being carried out for the Palestinian people, mostly non-Arabs were involved. "We," said Carlos in setting the man straight on what their aims were, "are working for revolution all over the world."

Quadafi is as key a figure as Carlos if not more so. He has plotted the overthrow of Presidents Sadat of Egypt, Numairi of the Sudan and Bourguiba of Tunisia plus the late King Faisal of Saudi Arabia. He has, with the aid of the oil money his once poverty-stricken nation now possesses, instigated and financed an extraordinary variety of terrorist operations including a 1973 attack on the Rome airport in which 32 were killed and 18 injured to a projected assassination of Henry Kissinger to Entebbe. The limits to which he will go were revealed by Anwar Sadat, who has stated that in 1973 Quadafi ordered two Egyptian submarines on loan to Libya to sink the liner Queen Elizabeth II as it steamed toward the port of Haifa to celebrate the 25th anniversary of the state of Israel.

The former bedouin Quadafi may be excused for his actions because of a basically unstable personality, but other governments are implicated just as much in the "Carlos Complex." The People's Republic of Yemen (formerly Aden) offers refuge to hijackers for a cut of the ransom money. Cuban diplomats in Paris were in frequent collusion with Carlos and three were expelled from France for it. The Soviet-influenced government of Somalia has been implicated in the Entebbe plot — as were, of course, the minions of Idi Amin's regime.

Western nations have also failed to live up to their responsibilities vis-a-vis the terrorists. Paris was for years the center of West European PLO activities and it

(continued on page 76)

SOLDIER OF FORTUNE

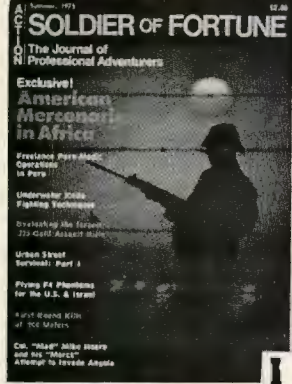

ISSUE NUMBER ONE \$2.50

American Mercenaries in Africa/Underwater Knife Fighting Techniques/Israeli Galil Assault Rifle/First Round Kills at 900 Meters/"Mad" Mike Hoare and His "Mercs" Attempt to Invade Angola/Jeff Cooper on Rhodesia/Flying F-4's for the U.S. and Israel

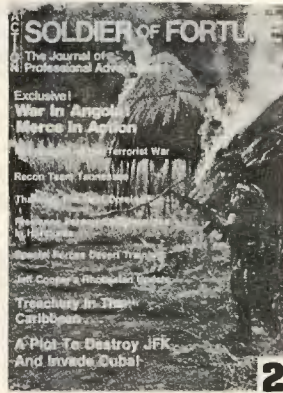

ISSUE NUMBER TWO \$2.50

War in Angola/Mercs in Action/Recon Team Tennessee/Special Forces Desert Training/Jeff Cooper's Rhodesian Update/Bayo-Pawley Affair A Plot to Destroy JFK and Invade Cuba/Mythologies of the Terrorist War/Free Lance Paramedics Jump into Honduras



ISSUE NUMBER THREE \$2.50

SOF Interviews a Nam Vet-FNLA Merc/Angola Flashbacks-Operation Diablo/"Mad Dog" Callan A Merc Runs Amok/Rhodesia Is Ready/Arrest in Zaire/Murderous Skies of Mozambique/Vietnam Disaster/Challenge of Deep Sea Diving/Evaluation of the Bushmaster and S&W M-76 SMG

READER SERVICE



ISSUE NUMBER FIVE \$2.50

Terror in Beirut An Inside Look at the PLO/Mercs of the American Revolution/Evaluation of the American 180 and Star PD 45/War in Rhodesia/Snake Bite/Spinning Death/Ralph Thorsen Modern Day Bounty Hunter/Murder in Luanda/SOF Interviews Sir Robert Thompson

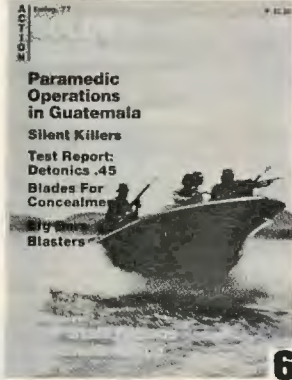

ISSUE NUMBER SIX \$2.50

SOF Interviews Rhodesian Army Recruiting Officer/SOF Recon Action in Southern Africa/Blades for Concealment/Black Water. Bodies & Bombs/Detonics 45 Auto Test and Evaluation/NRA Survival School/160 Hours Beneath the Mississippi/Paramedics in Guatemala/Big Bore Blasters

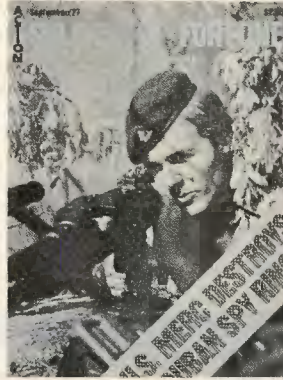

ISSUE NUMBER SEVEN \$2.50

Betrayal in Vietnam/American Merc Destroys Cuban Espionage Ring/Rhodesia - "Castle Keep" Operation Linebacker II Part I/R-76 Submachine Gun/M-16 Terror or Toy?/Sentry Removal

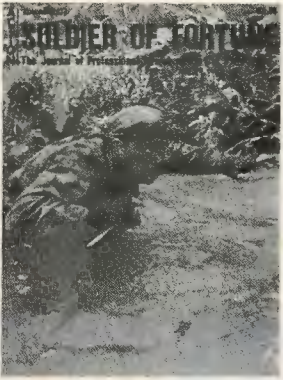

ISSUE NUMBER EIGHT \$2.50

Carter's Korean Sellout?/Nightwatch/Let's Print the Truth About Rhodesia/Israeli Defense Force/The Kill/South African Army Prepared for War/Objective Cotonou/SOF Interviews Mike Echanis/Sentry Removal/NRA Shakeup/Reloading for the M1A/The Best Combat Shooters in the U.S./Linebacker II Part 2/Adventure Quartermaster

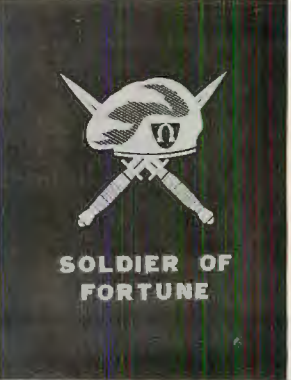

SOF BINDER \$5.95

Preserve your Issues of SOLDIER OF FORTUNE in this specially designed, attractive black with white logo, six issue binder

SOLDIER OF FORTUNE BACK ISSUES

- #1 \$2.50
 #2 \$2.50
 #3 \$2.50
 #5 \$2.50
 #6 \$2.50
 #7 \$2.50
 #8 \$2.50
 ALL SEVEN BACK ISSUES FOR ONLY \$14.00

SOLDIER OF FORTUNE BINDERS

PLEASE SEND ME (NUMBER) _____ SOF BINDER(S) AT \$5.95 each

SIX ISSUE SUBSCRIPTION TO SOLDIER OF FORTUNE - \$10.00

YES! I WOULD LIKE A SIX ISSUE SUBSCRIPTION TO SOLDIER OF FORTUNE

PLEASE CHECK NEW RENEWAL

NAME (PRINT) _____

ADDRESS _____

CITY _____

STATE _____ ZIP _____

PLEASE AFFIX OLD ADDRESS LABEL HERE

MY PAYMENT IS ENCLOSED. AMOUNT \$ _____

(PAYMENT WITH ORDER REQUIRED FOR BINDERS, BACK ISSUES)

PLEASE BILL ME (APPLIES ONLY TO NEW SUBSCRIPTION ORDERS WITHIN THE U.S.)

PLEASE ALLOW UP TO SIXTY DAYS FOR FIRST COPY OF YOUR SUBSCRIPTION

SOF-3/1

Bulletin Board

BOUNTY HUNTING IN RHODESIA

Special report from Rhodesian correspondent, John Kelley:

Ranchers in Rhodesia are offering \$1,600 a head for dead cattle rustlers. And if the rustler happens to have been a guerrilla, the Rhodesian government will match it.

More than 150 men are standing by in Britain waiting for security clearance to chase the rustlers. Soon they will be employed by ranchers to patrol areas of 90,000 acres and upwards. They will be expected to operate almost 24-hour watches and lay booby-traps together with their African trackers.

The government supplies the arms and grenades for the traps.

First man to tackle the job is 40-year-old Mike Prior, former British Army non-com who fought in Cyprus and who admits to "being in Africa before." He said, "Sure, I have a license to kill. There'll be no messing about. Any rustler gets it between the eyes.

"I haven't killed one yet, but the other day I just missed 12 of them. I was real mad about that because it would have been a nice few bucks."

Prior, of Nottinghamshire, England, said he did not regard himself as a bounty hunter. He is also paid a small salary and said he would still get a bonus if he killed nobody—provided no cattle had been lost.

Rhodesian ranchers have lost millions of dollars worth of cattle in recent months. Many of them have been forced to quit and leave ranches deserted after losing nearly all their stock. At Hammond Ranch near Mozambique, where Prior operates, owner Douglas Lilford lost \$22,000 worth in one month.

Rustlers tend to be tribesmen living in nearby reserves, whose own cattle have died because government agricultural workers cannot get in to treat them against diseases. The guerrillas ruthlessly refuse to help them by allowing a temporary truce. Guerrillas also insist tribesmen supply them with meat on pain of death or mutilation.

Other raiders are the Frelimo army of Mozambique, who are also starving due to lack of supplies.

Said Prior, "Pity the poor tribesman. If he fails to get the meat, he's dead. If he

comes on this ranch looking for it, he's also dead. The poor blighter cannot win.

"I stopped six men yesterday and made them strip. If I had seen a weapon or anything suspicious I'd have shot the lot."

Is there not a temptation to shoot almost anybody and claim the \$1,600?

"Certainly there is," admitted Prior. "But one has to resist that."

An Australian and two Rhodesians are to take up the rustler-hunting job soon. But there are none from the United States—so far.

Ranchers near the Botswana border on the other side of the country are going across the line themselves after stolen cattle. Police are forbidden to violate the border.

Said one, "To hell with borders. I can't afford to go broke through thievery, wherever it comes from."

GAMEWARDENS OF VIETNAM . . .

All personnel that served with Naval Task Force 116 in Nam are invited to join the Gamewardens of Vietnam Assn., Inc., P.O. Box 5523, Virginia Beach, VA 23455. Membership fee is \$3.00.

SAVE MORE THAN 90% IN AMMO COSTS!

... and PAY FOR THIS DEVICE before 300 rounds are expended!



The Atchisson Mark II .22 rimfire converter.

Duplicate the firing capabilities of the Ar 15 or M-16 A1 without duplicating the costs! This device enables conversion in seconds without the use of tools.

- Eliminates overpower & needless expense when training in indoor or outdoor ranges!
- Ideal for special military missions or police swat team operations!
- Comes in handy, sturdy, compartmentalized molded plastic case useful for storage between training sessions!

- Decreases "Weapon familiarization training time!"
 - Not a firearm—may be shipped or carried without restriction!
 - Allows 12 times the practice for the same costs!
 - Entire unit has only 10 parts, sans magazine!
 - Uses easily available .22 I.r. ammunition!
- Brochure Available on Request

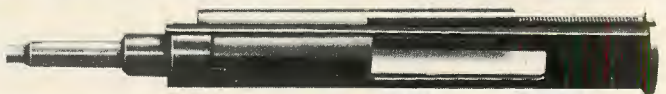

KIT AVAILABLE TWO WAYS:

KIT No. 1—Mark II semi-automatic 10rd. magazine (standard) **\$79⁹⁵**

KIT No. 2—Mark II selective fire 30rd. magazine (standard)* **\$99⁹⁵**

* (30 round magazine standard equipment with selective fire device only)



SHOOTS 12 ROUNDS OF .22 I.r. RIMFIRE FOR THE COSTS OF ONE 5.56 mm. COMBAT ROUND!

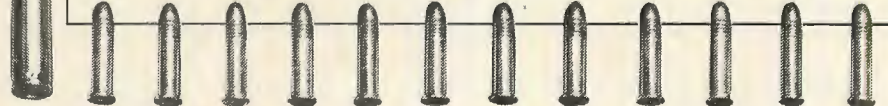

INTERNATIONALLY DISTRIBUTED BY:

BINGHAM I.L.D.

1775-C WILWAT DR
NORCROSS, GA 30093
ph 404/448-1440

RHODESIAN CONTACTS . . .

Many SOFers have requested we print the addresses of the Rhodesian security forces. For those interested, write to:

Recruiting Officer
British South Africa Police
General Headquarters
P.O. Box 8007
Causeway
Salisbury, Rhodesia

Recruiting Officer
Army Headquarters
P.O. Box 7720
Causeway
Salisbury, Rhodesia

Correspondence should be sent airmail as surface mail will take two months.

PARAMILITARY MARKETING . . .

We at SOF have received many complaints concerning Paramilitary Marketing's ability to complete order transactions. This may be due to a mistake in one of their ads. Their address should read, P.O. Box 662, Rosemont, IL 60018. If those of you who have not received their products could resubmit your order with your cancelled check, Paramilitary will process your request. Thank you.

COMMITTEE TO HELP THE FBI . . .

Herbert Philbrick is leading a drive to raise funds for those FBI agents who are being prosecuted by the Carter Adminis-

tration ("a born-again turkey is still a turkey"). Mail contributions to Committee To Help the FBI, P.O. Box 50147, Washington, D.C. 20004.

U.S. STATE DEPT. INFORMS ON CUBAN EXILES . . .

U.S. State Dept. admitted it gave Castro information on a projected invasion attempt by Cuban freedom fighters this summer. No comment.

TASER RESTRICTIONS . . .

The ATF has determined that the TASER is a "firearm" within the purview of 18 U.S.C.921 (a) (3) (A). It is also an "any other weapon" under the National Firearms Act 26 U.S.C.5845(c).

Weapons manufactured prior to May 1, 1976, will not be treated as subject to Chapters 44 & 27 of CFR Part 178. Weapons manufactured on or after May 1, 1976, are subject to all provisions of the National Firearms Act and 27 CFR Part 179. (ATF Rule 76-6).

27 CFR Part 179.82 imposes a \$5.00 transfer tax on each TASER subject to its control, and such weapons may only be purchased from an individual possessing a Class 6 FFL.

(continued on page 71)

SPECIAL OFFER TO SOF READERS FROM LOST WAX PRODUCTS, THE PRODUCERS OF THE SOF BELT BUCKLE: PERSONALIZED BELT BUCKLE

Have your own handle, call number, club, nickname, or ANYTHING YOU WANT cast in bronze or aluminum for your own personal, one of a kind, Belt Buckle. Only \$20.00, including p&h. Buckles are approximately 2 1/2"x 3 1/2", varying to fit the letters of your handle, etc.

OR, send us your design and for just \$40.00, including p&h we will HAND CARVE your buckle in bronze or aluminum.

LOST WAX PRODUCTS will cast anything in bronze or aluminum. IF THIS WOULD INTEREST YOU CONTACT US AT THE ADDRESS BELOW:

Send Check or money order to:

LOST WAX PRODUCTS

P.O. Box 4351

Boulder, Colorado 80306

NAME (PRINT) _____
ADDRESS _____
CITY _____
STATE _____
ZIP _____
I WOULD LIKE _____ ON BUCKLE
PLEASE CAST IN BRONZE _____ ALUMINUM _____

Get Free Facts! We Pay Postage

Start at home in spare time

When you become a Gun Pro Trainee at North American WE SHOW YOU HOW TO APPLY FOR A FEDERAL FIREARMS LICENSE!

PROFIT-ABLE HOME BUSINESS



LEARN GUN REPAIR

Top-Flight Gun "Pros" Tell You What To Do, How To Do It, Guide You Every Step of the Way. Start right now with no previous experience — You'll see how to take apart and repair almost every well-known rifle, shotgun, pistol and automatic. We take the mystery out of ballistics. Show you how to smooth up actions, fit and repair stocks, rechoke shotguns, customize handguns. Includes bedding techniques, stock inletting, how to buy and sell new and used guns. Big profit opportunities for the expert. Now at home in your spare time, you can learn the basics you need to become that expert and make the kind of money you deserve.

If you qualify otherwise, you may obtain a Federal License to buy and sell guns, ammunition and accessories without inventory . . . while you are still a student at North American.

This means you can begin making extra cash almost immediately — ordering guns for others on a cost-plus basis. It also helps you get started toward a business of your own . . . if that is what you want after you graduate.

No Previous Experience Needed.

First and Only Complete

Course of its Kind. You get it all!

How to buy and sell guns . . . customize, repair and accuzize them . . . fit and finish stocks . . . do handloading . . . zero-in scopes . . . understand ballistics . . . restore antique firearms . . . use black powder weapons . . . import guns . . . adjust chokes . . . and answer every question about almost anything in the field of guns, ammunition or shooting!

Because you study at home, you can go as fast as you want . . . or take it as easy as you wish. Set your own pace. Finish the course in months . . . or take up to two years. You are guided each step of the way by our expert faculty . . . and tested to make sure you understand each lesson before you go on to the next.

When you complete the course, you will be awarded a handsome Diploma that proclaims you a "GUN PRO." It's suitable for framing, and you can proudly display it in your own shop or wherever you work.



SPECIAL TOOLS AND EQUIPMENT INCLUDED. Everything explained in easy-to understand language. We send you tools so you actually learn by doing as you follow the lessons. You receive catalogs, bargain bulletins, requirements for Federal Firearms License.

North American School of Firearms, 4500 Campus Dr., Dept. RS0A7, Newport Beach, CA 92663.

WE PAY POSTAGE! Follow these Instructions: Paste, staple or tape label to upper right hand corner of any envelope. Enclose coupon and mail.

IN YOUR FIRST LESSON we reveal a secret of ballistics that can increase your hunting accuracy so dramatically . . . ALL YOUR FRIENDS WILL BEG YOU TO SHOW THEM HOW TO DO IT!

Mail Coupon in your Postage-Paid envelope

FIRST CLASS Permit No. 363 Newport Beach, California

BUSINESS REPLY MAIL

No Postage Stamp Necessary if Mailed in The United States

Postage Will Be Paid By:

NORTH AMERICAN SCHOOL OF FIREARMS
4500 Campus Drive
Newport Beach, CA 92663

Dept. RS0A7

CUT OUT COUPON — PLACE IN ENVELOPE.

North American School of Firearms, Dept. RS0A7
4500 Campus Dr., Newport Beach, CA 92663

RUSH ME INFORMATION telling how, for just a few dollars a month, I may learn to become a GUN PRO. NO COST . . . NO OBLIGATION. No salesman will call.

NAME _____ AGE _____

ADDRESS _____

CITY _____ STATE _____ ZIP _____

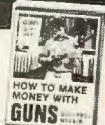

Ninja Training Equipment

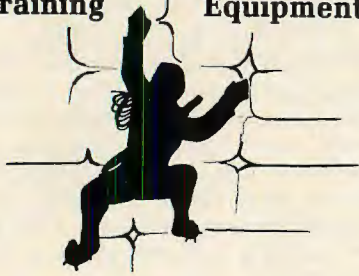

Uniforms

Black jacket with hidden shuriken pocket. Black pants with leg ties. 2 arm guards and headband.

Small \$35.00
Medium \$37.50
Large \$40.00

Tabi (shoes)

Black hitop cotton canvas with special sole and toe grips.
Sizes 7-11 \$27.50

Ninja Combat System
(A Training Manual)
\$5.00

Shuriken
\$2.50 each or 3 for \$6.50

Ninja
P.O. Box 28222
Atlanta, Ga. 30328

TERRAIN AND SITUATION NO. 6

BY JERRY AHERN

A few years back, Charter Arms (430 Sniffens Lane, Stratford, Conn. 06497) introduced the first commercial .44 Special revolver to come down the pike in a good two decades. It was the three-inch barrel .44 Bulldog, a fixed sight five-shot cylinder gun with beefy wooden grips and lightweight construction. Yet, though occasionally some screws started working loose, the little gun seemed capable of digesting moderately hot handloads within the recoil capacity of a 19-ounce gun. It would be extremely unwise and masochistic to run .44 Special loads that would make a Model 29 or a Ruger Super Blackhawk twitch through such a lightweight gun.

Even with factory loads, the big (246-gr.), slow moving bullet had a lot to be said for it in knockdown power. The continued popularity of this pint-sized blaster has now led to still another .44 Special from Charter, this Bulldog sporting a four-inch tube and fully adjustable rear sights.

Firing the new .44 was quite an experience. To begin with, in such a lightweight, arm recoil from a four-inch tube was definitely challenging, and there is no way I could see myself standing around for hours, plinking away with such a gun. Yet, recoil was manageable and not so unpleasant as to be painful. Functioning of the .44 was reliable and smooth, the single-action pull breaking well and the DA pull even and not overly heavy. One difficulty of little consequence except to someone who likes to pattern load was the binding of the cylinder which occurred with the gun fully loaded, cylinder out. Apparently, the case rim closest to the frame made contact with the frame itself with the cylinder positioned for reloading. This in no way hampered closing the cylinder, nor proper indexing. Cylinder lock-up was tight when I started and tight when I finished shooting. And, on this gun, no screws seemed to have loosened.

What the new .44 Bulldog with longer barrel and better sights offers is quite a lot. For the police officer who must carry

a revolver and feels a big bullet is the answer, the new gun, with well-constructed handloads, might well be the answer. For the homeowner, looking for a revolver spitting sizable chunks of lead without sufficiently high velocity to drive the projectile through several walls in the event of a miss, it is a marvelous solution. In the field, it obviously does not compare to a .44 Magnum, yet packs sufficient punch to knock down most men and beasts with a solid hit. The .44 Bulldog was a compromise gun in its original form and with the new barrel and sights is still that, but much more viable. For those needing a big bullet in a revolver that is easy to conceal and light enough to carry all day with comfort, the Bulldog .44 from Charter Arms is the only game in town. And, with the quality of construction evinced in my test sample, the new bigbore Charter is a fine, well-made gun to boot. Learning to handle the Bulldog is not difficult, either. After a few rounds for familiarization, my nephew, George Smith, who'd never fired a handgun before in his life, was keeping everything in the chest area of a Colt Silhouette at a rough 25 feet. If a bigbore DA revolver is what you're looking for, check out the new Charter.

The Barami Corporation (6250 E. Seven Mile Rd., Detroit, Mich. 48234), much to my consternation and with my definite approval, has put me in the awkward position of wanting to use two pairs of grips for the same gun. For quite a few years, these folks have been marketing a replacement right-grip panel for Smith & Wesson and Colt revolvers, as well as the Charter Arms guns. The device was made of high-impact resistant black ABS plastic and featured a shelf extending from the uppermost portion of the grip and slightly away from the frame. Known as the Hip Grip, it allowed a revolver packer to stuff the gun in his pants sans holster and know that regardless of what physical activity he engaged

THE COMPLETE CIA & SPECIAL FORCES

• IMPROVISED MUNITIONS •

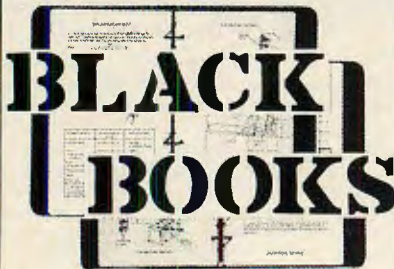

These books were originally developed by the FRANKFORD ARSENAL for the CIA and SPECIAL FORCES. They are the most detailed and comprehensive works ever done on the subject of improvised weapons. For years they have been the most sought after and secretive books ever published by the AMERICAN MILITARY. Only after lengthy and extensive research have we been able to acquire these complete original books and are now making them available to you. Anyone who can foresee the troubled times ahead should not be without the knowledge contained in these books.

— Improvised Munitions Black Books —

(BB-1) Vol. 1, 147 Pg. \$9.95
(BB-2) Vol. 2, 141 Pg. \$9.95

DESERT PUBLICATIONS

P.O. Box 22005 Phoenix, AZ 85028

I have enclosed \$_____ Please Rush me:
____ copy(s) of BB-1
____ copy(s) of BB-2

NAME _____

ADDRESS _____

CITY _____ STATE _____ ZIP _____

in, short of hanging upside down, the gun would still be there. That little shelf worked like a hook to hang the gun on the trouser waistband or belt and did away completely with the need for a holster under conditions of extreme concealment. In addition to this, it was a damned sight nicer looking than a lot of rubber bands wrapped around the butt to add friction to hold a snubby revolver in place.

I used one of these little devices from time to time with great satisfaction. Yet something about it offended my aesthetic sense. The black plastic right-grip panel looked terrible with the brown wooden grip on the left. Yet when ultimate concealment was required, on went the black plastic Hip Grip.

Now, Barami has met the challenge. Though still providing the replacement right-grip panel only, they also offer a matched set, with the actual Hip Grip as the right panel and an identical black ABS plastic grip, sans shelf, for the left side. Now my aesthetics are satisfied, as will be those of a lot of handgunners, I'd bet. And, at a price of \$10.95 for such a truly useful device, plus considering how well the panels mate to the metal, the new double Hip Grip should cause quite a stir.

But my problem still remains. It is threefold. The grips presently on my little S&W Model 60 stainless are truly sensational. And as the author of a column on holsters in another magazine, I feel a certain loyalty to packing handguns in leather. But the undeniable facts are that when it comes to concealing a J-Frame S&W or similar sized revolver—and the Hip Grip is for revolvers only—nothing does it better. So, looks like I'll just have to get out the old screwdriver and keep switching grips or buy a second short-tubed wheelgun.

The Flicket, made by C.K.C. Manufacturing, P.O. Box 308, 110 Crogan St., Lawrenceville, Ga. 30246, is one of those handy little devices you probably never thought about, then saw it and realized you couldn't live without it. And at a price of \$2.95, the investment is such that it seems almost foolish not to buy one. What is it? The Flicket is a chrome-plated steel device which pinches firmly onto the spine of a lockblade folding knife, comes in three different sizes to work with most knives, and has a tiny shelf extending from it. The shelf, extending about 1/4 inch to the right of the blade when the knife is closed, point toward the user, allows the thumb to push the blade open in one smooth motion, just like the fastest one-hand opening techniques, and without all the practice. The Flicket is as simple as that. It works, is reliable and highly practical. For fast field use of a lockblade folder, it works so well it will probably become habit forming.

As this is written, a very sick man has just been apprehended in New York City, after a series of murders with a large caliber revolver. This case as well as many others where mentally unstable people use firearms to kill, will like as not be used by the anti-gunners some time soon to exemplify handgun use and as one more reason why private ownership of handguns should be abolished in the United States. Just as most anti-gun arguments, this doesn't wash. Demented minds have been with us long before handguns were invented and will be with us forever, barring medical breakthroughs we cannot yet envision. Criminal minds will also be with us, using guns, knives, or anything else to force their will and deprive others of life and property. Thankfully, criminals and the mentally aberrant are a minority. They get great press coverage—especially when armed with a gun—but what is un-

sual or bizarre is always news. Taking an average year's murder rate and figuring it against the estimated number of handguns in private ownership, it works out to significantly less than one per cent of privately owned handguns killing anyone. The actual number is below two-hundredths of a per cent. Question: Has the United States really gotten to the point where it will deny a fundamental liberty to the great mass of the population in order to ineffectually attempt to prevent the unconscionable acts of the few?



MODERN - OBSOLETE - FOREIGN
DOMESTIC - MILITARY - SPORTING
WORLD'S LARGEST SUPPLIER
GIANT CATALOG 7
\$2.00 PPD
GUN-PARTS
NUMRICH ARMS CORP.
Box SF 8, W. Hurley, N.Y. 12491

CAMOUFLAGE TIGER STRIPE

FIELD JACKETS

M-65 STYLE
100% COTTON
VELCRO TAPS
ZIPPER & SNAP FRONT
FOUR LARGE POCKETS
HOOD IN COLLAR
AMERICAN MADE
SIZES: XS-S-M-L-XL*
PRICE: \$34.00 & \$37.00*
PLUS \$2.00 SHIPPING & HANDLING

JUNGLE HATS

G.I. BOONIE HAT STYLE
100% COTTON
NYLON MESH LINING
BULLET CARRIERS
ADJUSTABLE CHIN STRAP
MADE TO GOVT. SPECIFICATIONS
ALL AMERICAN MADE
SIZES: S-M-L-XL
PRICE: \$5.00
PLUS 50¢ SHIPPING & HANDLING

TIGER STRIPE FATIGUES

EARLY VIETNAM STYLE

100% COTTON - VAT DYED
TOP QUALITY - AMERICAN MADE
JACKET SIZES: SMALL, MEDIUM, LARGE, EXTRA LARGE
PANTS SIZES: 30" WAIST THRU 44" WAIST - ALL BOOT LENGTH
PRICE: \$20.00 PER SET PLUS \$2.00 SHIPPING & HANDLING
ALSO AVAILABLE IN LEAF PATTERN.

Rocket Surplus Sales

2229 VANDALIA • COLLINSVILLE, ILL. 62234
PHONE 618-345-0890

NAME _____

ADDRESS _____

CITY _____ STATE _____ ZIP _____

PAYMENT BY: CASH MONEY ORDER CHECK* MASTER CHARGE

MASTER CHARGE ACCOUNT NUMBER _____

CARD EXPIRATION DATE _____

(*ALL CHECK ORDERS HELD 3 WEEKS)

PLEASE SHIP ME THE FOLLOWING —

M-65 FIELD JACKET(S) _____

JUNGLE HAT(S) _____

FATIGUE JACKET(S) _____

FATIGUE PANT(S) _____

SORRY NO C.O.D. ORDERS

SOF EXCLUSIVE: AFRICA IS BURNING

BY AL J VENTER



African troopers are armed with a variety of weapons which vary greatly in effectiveness.

EDITOR'S NOTE:

After this article was prepared, certain events occurred in Africa with such rapidity that it was necessary to add this update.

During the last week of July, Egypt and Libya conducted a minor war against one another, involving large numbers of armored equipment and war planes. A shaky truce was negotiated, while Egypt used the incident to press for new military equipment from its new ally, the U.S. The American government refused to give or sell Egypt any fighter planes to replace the Russian-made Migs owned by Egypt, many of which were grounded by lack of spare parts, due to the severance of military agreements between Egypt and the Soviet Union. Instead, the U.S. government announced arrangements to retrofit Egyptian Mig aircraft with English jet engines — American engines would have been more suitable, but the idea was too politically volatile for the Carter Administration — said to provide better performance than the original Russian engines.

An even more ironic situation is developing in the Somalia/Ethiopian conflict, where Ethiopia is using its entirely American-equipped army to fight the Russian-equipped Somali army. However, the Russian government is now backing the Ethiopians, while the U.S. has switched its support to the Somalians. The result is that the U.S.-supported side, Somalia, is busily shooting down American-made F-86 and F-5E jet fighters with its Russian-made Mig fighters, all with the blessings of the American government, while the Russians are encouraging their side in its destruction of Russian equipment given to the Somalians. Machiavelli would be proud of African politics today.

To date, Ethiopia's "proletarian army" has not shifted the balance of power from the Eritrean rebels in the northern portions of Ethiopia. The Marxist Ethiopian government is learning the lesson the mercs taught in the Congo in the 1960s: that poorly-trained masses cannot succeed against lesser numbers of better-trained (and motivated) soldiers.

It has taken exactly three years for the focus of international attention — where war, insurrection and revolt are concerned — to switch from the carnage of Vietnam and Cambodia to the African mainland.

Like a modern tragedy unfolding on a dingy stage, these have been an eventful 36 months for what has overnight become the world's most turbulent continent.

It is all the more distressing for those with a stake in the African future when one is aware that the apogee of bloodletting has not yet been reached. There is more murder and mayhem to come.

The period has spawned the specter of aggressive Soviet involvement in the affairs of a number of black states and witnessed Cuba's unheralded implication in the military stakes of several African nations.

There has also been an escalation in the level of hostilities in Southern Africa, the bloody overthrow of several respected African Heads of States — including those of Nigeria, the Congo and Ethiopia — as well as border disputes between a number of countries which these days seem more bent on using force than mediation in a quest for a solution.

More ominous still, it would appear that the day of the mercenary has not yet ended, for there are still mercs active in Angola.

Apart from the use of these dogs of war to ill effect during the Angolan debacle, mercenaries subsequently appeared in an abortive invasion of the miniscule west African Marxist Republic of Benin. The attack by hired guns — apparently with French backing — lasted about 48 hours, after which most of these adventurers climbed back onboard their chartered DC-8 jetliner and left for destinations unknown.

Another startling development during this unhappy phase of African history was the involvement, for the first time, of a white, Southern African state — this time South Africa — in the military affairs of a black state to the north: in this instance, Angola. South Africa has since withdrawn, but left some of her men behind as prisoners of war. These POWs are still being held in Luanda.

A succession of flashpoints have ripped entire regions of Africa apart. Not limited to any one area, brutal and oft-time gory rebellions have encompassed the affairs of more than a dozen states, and about the only thing that is certain is that more blood will flow in the immediate future.

For while most of the world's attention has been focused on military developments in Angola, and, more recently, the invasion by Cuban-backed Katangese rebels into Southern Zaire (a conflict which now threatens to develop into a



full-scale guerrilla war where once again the influence of Moscow is manifest) hostilities are a daily event elsewhere.

In the extreme western corner of Africa, a fairly substantial war is being fought in the arid wastes of what was once known as Spanish Sahara. Here several countries are involved: Morocco and impoverished Mauritania, on the one hand, backed by the West and an army of Algerian-supported Polisario Front guerrillas, on the other, armed and aided by the communist powers.

Clearly, a long term affair, the war in the Western Sahara has already developed into a full-blown ideological conflict. The most recent event in early May was the murder of several French expatriate workers and their families in a Mauritanian mining village by Polisario insurgents. The gesture was a bid to deter further French involvement in hostilities and has severely strained Franco-Algerian relations.

In Ethiopia, developments have been even more drastic. Recent events included the slaughter of more than 300 university students at Addis Ababa University, also early May.

All these youngsters were diametrically opposed to the tyranny of the Ethiopian leader, Major Mengistu Haile Mariam (now known as the butcher of Addis Ababa). They were massacred by the vanguard of a radical "People's Army" which has been formed specifically for the purpose of countering the Eritrean Liberation Front insurrection on the Red Sea, a guerrilla war which has been simmering for a decade and a half.

According to sporadic reports filtering out of the Ethiopian capital, the massacre can be regarded as little more than a preliminary for what is still to come.

One East African source quoted by Nairobi's *Daily Nation* maintained that once Ethiopia's "proletarian army" of about 200,000 peasants (the majority of whom have received only one month's military training at the hands of Cubans and East Germans and have been armed with Soviet ordnance) is let loose against the Eritreans in the north of the country, the slaughter which is likely to result will be the bloodiest annihilation of one people by another in contemporary African history.

He phrased it this way: "It will make military events in both Biafra and Angola look like an afternoon's military maneuvers on Canterbury Plain."

Long term portents for East Africa are ominous. With the independence of the Territory of Afars and Issa imminent (the French colony, the last in Africa, was formerly called French Solmaliland), Ethiopia and Somalia are preparing for a major military showdown. Both nations claim that the tiny Red Sea enclave which is only a little bigger than Swaziland and includes the modern harbor of Djibouti, is theirs by traditional historical right.

While Somalia reckons that the desert territory has always been part of Greater Somalia, Afars, linked by rail to the Ethiopian capital of Addis Ababa, has overnight become a pawn in the Big Power stakes for this corner of Africa.

Issues are further complicated by the fact that Ethiopia, for long the major recipient of American military aid in Africa, has overnight switched allegiances to Russia.

President Mengistu, a Marxist, has recently returned from a state visit to Moscow. On his return, he denounced what he termed "American Imperialism" and has embraced the Soviet Bear as the benefactor of all things bright and beautiful, including huge quantities of sophisticated war materials.

The problem, essentially, is that while Ethiopia is a newcomer within the ranks of Soviet recruits, Somalia has been a staunch Russian ally for most of this decade.

During this time, Moscow has helped build up the Somali military machine into one of the most formidable on the continent; in return, the Mogadishu government has granted Soviet Russia unlimited defense facilities on her soil, including, it is reported by Western intelligence sources, missile bases along the Somali coast.

What makes the Ethiopian-Somalia confrontation particularly hazardous to this part of Africa is that both nations are armed with modern destructive weapons.

Ethiopia (according to London's International Institute of Strategic Studies) has a regular army of about 50,000 men backed by battalions of tanks (mostly American) and an air force of 36 combat aircraft including US-supplied F-86 and F-5 fighters and Canberra bombers. Ethiopia also has a sizable navy by African standards, again, mostly American issue.

In contrast, Somalia, with a defense establishment half that size, is far better equipped and trained.



Notorious English merc, Col. Callan, armed with CIA-provided M-2 carbine, executed in Angola in July '76. Opportunities for mercs will continue as long as Africa "burns."



Above: Rhodesian terrorists training in Mozambique during early phase of terrorist/guerrilla war. Now terrs are well equipped with modern communist-made arms.

Below: Zairean troops at assembly area, prior to battling Cuban-directed Katangese mercs in southern Shaba Province. U.S. refused to ship M-16 ammo for Zairean troops.



The Somalis are able to field six tank battalions, nine mechanized infantry battalions and 13 other battalions, including two specializing in commando work. These units are supported by 250 Soviet T-34 and T-54 tanks, together with more than 300 armed personnel carriers and other vehicles of war. Somalia also has on hand almost 500 pieces of artillery and, according to recent reports, her forces know how to use them.

Coupled with this is the Somali Air Force, fielding 70-odd combat aircraft which include Mig-21 fighters and Ilyushin-II-28 bombers.

Somalia's territorial claims do not only extend northwards into Ethiopia. Kenya has also been a target over the years with Mogadishu claiming parts of Kenya's Northern Frontier District as its own in much the same way as Somalia has laid claim to Ethiopia's Ogaden Province. Several times Somalia's claims have been backed by force in allowing Shifita guerrillas to strike across the border.

For its part, the Nairobi government has entered the arms race somewhat belatedly, for while the Kenya defense establishment numbers less than 10,000 men, President Mzee Kenyatta has launched a crash training program, involving the help of Britain and the United States. Fox scout cars are on order from Britain and a dozen F-5E fighters have arrived from the United States.

While politics in East Africa remain in a state of flux, pending the final dismemberment of the East African community (Kenya, Tanzania and Uganda), the potential for real military involvement in one territory or the other remains.

In this capacity, Uganda continues to stir unrest with several of her neighbors, notably Kenya and Tanzania. Also, it is no accident that with the help of the Soviets and several Arab powers (including Libya and Algeria) President Idi Amin has built up a sizable defense force in his otherwise economically crippled nation.

Uganda's total armed forces at present number somewhere in the region of 25,000, including a variety of specialized infantry and commando battalions as well as an air force composed of two squadrons of Soviet Mig fighters. Amin also boasts an anti-tank missile capacity (Sagger-guided missiles), helicopter squadrons and more armor than any other country in what was once known as British East Africa, Zambia included.

Nor has this military force been inactive. Following a spate of claims and counter-claims, Uganda is known to have launched at least one invasion force into Tanzania; this was across the narrow stretch of territory which separates Lake Victoria from the former Belgian colonies of Rwanda and Burundi.

In a saber-rattling bid to back his claim for territory which he maintains is rightfully his, Amin has also moved some of his armor to the Kenyan frontier. This is

one of the reasons why Kenya last year hastily approached a number of Western powers in a bid to raise the level of fighting power of her armed forces.

More recently, Field Marshal Idi Amin has had a hand in developments in Zaire. Following the Angolan-backed Katangese invasion of Shaba province, the erratic leader committed a section of his "Suicide Battalion" to help oust the invaders.

Recent reports emanating from Central Africa indicate that the fighting prowess of the Ugandans in Zaire, despite the presence of their supreme commander for a short period, leave much to be desired. In one onslaught west of Kolwezi, Moroccan troops had to spend time regrouping a Ugandan "suicide" contingent after they had dropped their weapons and fled into the bush following a brief Katangese rocket attack.

While conditions along Uganda's borders remain unsteady, there are several other states where internal dissension threatens more drastic action.

We have the People's Republic of the Congo where political dissidents assassinated the president earlier this year. This was followed by brutal recriminations at the hands of mobs who roamed the streets looking for the killers. Among those hacked to death were a former President of the Congo and the Roman Catholic Archbishop of Brazzaville.

One can only speculate what the international reaction would have been had one of the Rhodesian or South African religious leaders died under similar circumstances.

Southern Sudan, for long a region nurturing its own civil war, remains in the political wilderness with the former Anyanya guerrillas once again threatening to take up arms to drive out their Arab overlords from the north. In the past, Anyanya — supported by the West and Israel, while the Sudanese obtained the bulk of their succor from the Egyptians and communist sources — spent almost two decades fighting for liberty.

Recent months have seen several southern separatist leaders making clandestine claims that this war is likely to erupt again.

Resenting Khartoum's largely Arab-orientated control of a basically Christian and animist region bordering on Kenya and Uganda, rebel leaders have again made a call of war. Among the states approached for weapons are the United States, Israel, and certain European powers, including France.

Developments are interesting within the context of inter-African power play. Because Sudan has sided with the Anti-Ethiopian Eritrean rebels for so long, Addis Ababa now also has a hand in fostering revolt in Sudan's southern Equatoria Province: An eye for an eye . . .

A similar state of affairs holds for Burundi, further to the south where the



Above: Zairean troops prepare for battle near Angola border in Shaba province formerly known as Katanga. Note Moroccan advisor with beret in center.

Below: Mercs will continue to play significant roles in African conflicts as majority of black troops are poorly trained, disciplined; have little technical expertise. Note DShK 38/46 12.7mm heavy machine gun mounted in Land Rover with anti-aircraft sights.



minority Tutsi tribe have waged a series of murderous tribal campaigns against their diminutive fellow-countrymen, the Hutu. Time was, only two years ago, that tens of thousands of Hutu were being exterminated like vermin wherever they were found. Rivers and ravines in this part of Africa were choked with bodies; the Hutu people who survived ran for their lives into any neighboring territory that would have them. The majority still live as refugees in Tanzania, Rwanda and Zaire.

Observers who were present at that time noted that the Burundi massacres were among the most vicious and systematic displays of genocide Africa has seen since the Biafran debacle. The killings went on for months, and they were documented by the international community.

But the world did nothing. The issue did not even rate a mention in the United Nations.

Another brutal dictatorship where there has been huge loss of life during the past 12 months is Equatorial Guinea, once a colony of Spain on the west coast of Africa.

This state is composed of a tiny sliver of territory on the mainland together with an island, formerly known as Fernando Po.

It is not for nothing that the region was known to travelers of old as The Armpit of Africa, for it lies only 20 minutes by air from the steamy Nigerian and Camerounian coasts.

Equatorial Guinea, like Burundi, has seen a program of orchestrated violence which holds few pangs in the twentieth century.

Anyone who is regarded as a threat to the security of the state — suspicion is enough to draw the maximum penalty — is liquidated by as efficient a bevy of security cutthroats as can be found. A score of cabinet ministers are numbered among those who have been murdered by the oligarch Macias Nguema, the man who came to power and then killed the majority of those who brought him there.

No journalists have been allowed into Equatorial Guinea for years; all reports of events on the island come by word of mouth from survivors who are prepared to paddle 50 kilometers by dug-out canoe through shark-infested waters to the African mainland.

But it is in Southern Africa that the turbulence that is now sweeping Africa is really making itself felt. Here, in a string of countries stretching from the South Atlantic to the Indian Ocean, a spate of military conflicts threatens to set the entire sub-continent alight.

Apart from Angola, wars — fired and fueled by the Soviets — are being fought along the South West African frontier with this former Portuguese colony. There are regular clashes in Rhodesia, in Zaire and in certain parts of Mozambique, where anti-Frelimo dissidents have recently made their military presence felt.

It is in Angola where the fiercest fighting in Africa's current phase is to be seen. The war continues on several fronts in spite of denials by the Luanda regime of President Agostinho Neto and the presence of almost 18,000 to 25,000 Cubans in the country.

Military operations are at present being conducted in the southern and south-eastern provinces against Unita; in the north against Holden Roberto's FNLA and in Cabinda.

In thimble-sized, oil-rich Cabinda where Gulf Oil continues providing the Marxist government with valuable revenues, the anti-MPLA liberation group which calls itself FLEC has made valuable gains since early 1977. The strength of this organization — which has French mercenary backing from at least one Biafran and Congo veteran, Bob Denard, and operates from Gabon — stems from the fact that Cabinda lies across the Congo River and the war there presents the MPLA with huge logistical problems. Most equipment has to be flown there or shipped to the enclave by boat.

There is also the Maiombe Forest, reckoned by naturalists to be equal to the most densely foliated equatorial regions of the Amazon basin.

This is the country that FLEC knows and where it has made its most substantial gains. Twice I have visited this area during the course of the past decade. Twice I have been awed by this incredible dense jungle where it seems impossible for man or beast to survive.

But they do, for FLEC has become a serious impediment to President Neto normalizing relations in this part of his domain.

In Northern Angola, the rebel FNLA movement which is headquartered in Zaire (thus Neto's backing the Katangese invasion into Southern Zaire) continues its probing guerrilla thrusts against combined Cuban and MPLA forces.

In recent months FNLA fiber has been stiffened by the recruitment of fairly large numbers of American mercenaries (almost all ex-Vietnam vets) who are now waging long-range strike operations against the Luanda Government. The system, basically, is one or two experienced veterans working closely with a 10 or 12-man FNLA "stick" behind enemy lines. This long range jungle penetration operation has had a severe effect on MPLA and Cuban morale.

Cuban casualties have also been a significant factor. Although only a few Cubans die each week, these figures mount up over a year, presenting Castro with his biggest problem since he allowed his forces to enter the African theater of operations. Cuban casualties since the start of operations are reckoned to be well into four figures.

Observers who are familiar with developments in the north maintain that the FNLA operation is the first clandestine policy gesture by America's Central Intelligence Agency since Watergate.

Nor is Dr. Jonas Savimbi of Unita any less active in Angola's southern regions. Despite massive onslaughts — backed by tanks, armored cars and Mig fighters — in a bid to flush out Unita fighting elements from their traditional Ovimbundu tribal areas, success has been marginal. Huge numbers of innocent civilians, including women and children, have died at the hands of government troops; others have fled as refugees to South West Africa. But Unita fights on, and judging by admissions made recently by Neto in Luanda, with some success.

It is axiomatic that in order to fight a guerrilla war, the rebel army needs support. It has puzzled observers where Unita obtains its logistical support, for ostensibly no African state is prepared to help a secessionist movement.

The truth is that much of the support needed by the Unita army still enters southern and eastern Angola from Zaire and, surprisingly, Zambia. Unquestionably, Unita elements who have crossed



A F.N.L.A. Panhard armored car is wheeled aboard a Zairean C-130. F.N.L.A. troops were no match for Cuban regulars in Angola. Mercs arrived too late.

the border southwards are also providing what assistance they can.

Further to the east, Rhodesia continues its own form of guerrilla war with casualties being released to the Press on a daily basis. Conditions within the operational areas — there are now four: Hurrricane, Repulse, Thrasher and Tangent — have deteriorated somewhat during the past year, but the Rhodesian High Command has somehow managed to stay abreast of the problems.

But Mr. Ian Smith's problems are not only military. Following his acceptance of the concept of majority rule during the visit of former American Secretary of State Dr. Henry Kissinger, most Rhodesians now accept that they are no longer fighting for the Rhodesian homeland, but rather for the means of hand-over to a black majority.

The issue now, basically, is whether the whites hand over power to black political moderates amenable to their presence, or to Marxist hardliners such as Robert Mugabe who ultimately sees Rhodesia — or Zimbabwe as it will be called — as a communist state invested with the task of continuing the black military revolution southwards.

The Rhodesian Government in its efforts to contain terrorism is not helped by the daily departure of about 50 of its white nationals, nor by pressure which has in the past been exerted by the South African Government.

The Rhodesian economy is also feeling the pinch. Industries are running at the lowest level of capacity ever, and farms are affected by continual call-ups. Recent reports indicate that groups of farmers in some of the worst disputed areas are now leaving the land and heading southwards. Among these numbers are some second and third generation Afrikaans-speaking agriculturalists.

The majority of Rhodesia's problems stem directly from Mozambique's involvement in the war, for without active participation from Samora Machel's radical Maputo government, Rhodesian forces would have flushed out the enemy long ago. All Soviet, East European and Chinese military aid to the Zimbabwe People's Army is channelled through Mozambique's two ports of Beira and Maputo (formerly Lourenco Marques).

But everything is not well in Machel's backyard either, for following his harsh Marxist-Leninist decrees which have made Mozambique a carbon-copy of a Comintern state, there have been rumblings of discontent from many of the traditionalists, including most of the larger tribes. In parts of the northwest there has been open rebellion.

Machel's biggest mistake could well have been his declaring Mozambique an atheist communist state, especially since a large proportion (between 50 and 60%) of its 10 million people follow the Islamic faith. Here the Macondes and coastal Makuas, both traditionally from the north, have reacted strongly, in some cases backing their sentiments with military action.

The rebels have no shortage of weapons. Following the end of Frelimo's war against the Portuguese, many of these insurgents buried their guns and ammunition in the forest. Much of this hardware has been retrieved and used to excellent effect in the present dispute, so much so, in fact, that President Machel has had to admit that a large proportion of his militia is now engaged in a form of protracted guerrilla warfare similar to that engaged by the Portuguese in the Mweda and Cabo Delgado regions of Northern Mozambique during the past decade.



A tyrant on his throne. Dictator and President-for-Life Idi Amin, his chest bedecked with self-awarded medals, reviews a parade in Kampala, Uganda. Third World nations refuse to condemn this bloodthirsty killer.

There is more anti-government activity in the south from an organization which calls itself FUMO.

Restricting its military activities to the Gaza Province adjoining Maputo Province and the region near the Rhodesian frontier, FUMO has been successful in a number of two and three-day engagements against Frelimo government forces. First hand reports from this region maintain that many of Machel's claims that Rhodesian troops have engaged his forces are, in fact, admissions of FUMO's military activities.

It is significant that when the Rhodesian army goes into Mozambique on retaliatory strikes, they go in, do their business, and get out. Any such operation in the past has rarely taken longer than a few hours.

FUMO, on the other hand, lacking the training of the average Rhodesian
(continued on page 68)



The face of war in Southern Africa. This white was executed and burned by insurgents in southern Angola. Both blacks and whites are victims of mutilations and

out-of-hand executions in most war zones. If captured, you don't have to worry about hiring a lawyer.

AND THEY WERE THE PROS?

A Professional Soldier Evaluates CIA/Cuban Exile Operations

by Bradley Ayers

At the age of 18, Bradley Earl Ayers enlisted in the U.S. Army paratroopers. In his 12 years of military service he was promoted through the infantry ranks from private to captain. He is qualified as a master parachutist, underwater demolitions swimmer, mountaineer, aircraft pilot, and flight instructor. He has received various awards and decorations for his military exploits.

In early 1963, Ayers was selected by the Department of Defense for a sensitive, undercover assignment with the U.S. Central Intelligence Agency. Upon completion of this top secret mission in late 1964, he resigned his Army commission. He was honorably discharged and in 1965 organized his own air charter company. He has been active as a real estate broker and private investigator.

Captain Bradley E. Ayers was serving as the Executive Officer of the U.S. Army Ranger Training Camp at Eglin AFB, Florida in the spring of 1963 when he was ordered to the Pentagon for a secret assignment. He and an Engineer Officer-demolitions expert, Major "Wes" Westrum, after undergoing extensive security screening, were given an opportunity to "volunteer" for undercover

Crew member of CIA mother ship *Leda* ducks from photographer as he works on a V-20, a high powered speed boat used to carry Cuban exile command teams to their objectives. Note MG stanchion (see arrow) for .30 cal. Browning. V-20's

also carried .50 cal. Brownings, emplaced at sea on mounts bolted into plates embedded in fiber glass. Armor plating was embedded in fiber glass to protect fuel tanks and personnel. Each cost over \$30,000.

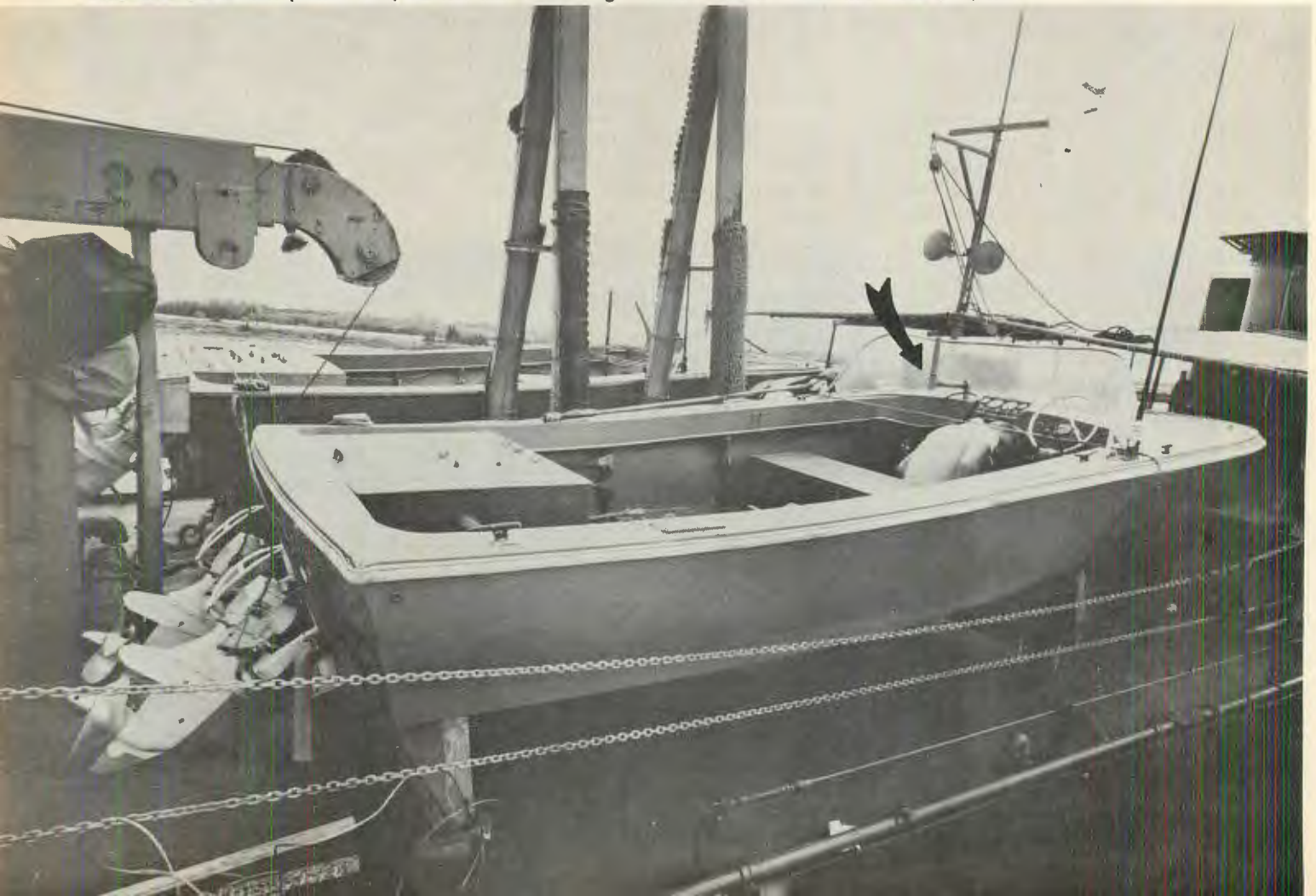



This CIA raider/mother ship was photographed anchored within eyesight of former President John F. Kennedy's West Palm Beach retreat in October 1963.

The CIA had several such vessels which were recon-ditioned WW II U.S. Navy Patrol Craft. They were equipped with sophisticated communication and navigational gear, but lightly armed.

assignments with the CIA. Both officers were subsequently placed on "loan" to the agency and were assigned to JM-WAVE, the Miami CIA Station, in connection with the CIA's intense covert paramilitary war against Fidel Castro.

The Kennedy Administration had been sponsoring paramilitary and espionage operations, under the supervision of the Central Intelligence Agency, designed to harass, disrupt, and weaken Cuba since shortly after the Bay of Pigs in April 1961.

In the spring of 1963, following the Cuban missile crisis and supported by the Administration's Latin American policy, these actions received increased attention under the direction of the newly formed "Standing Group," also known at that time as the Special Group, and the National Security Council. Attorney General Robert Kennedy, the director of the CIA, and the Joint Chiefs of Staff were the principal voices of the Standing Group.

The CIA's secret war against Castro was not limited to clandestine paramilitary activity. Code named "Operation Mongoose," the CIA focused its efforts on every aspect of Cuban communist life and included international economic and trade boycotts, penetration and subversion of Latin American political and labor

organizations, and infiltration and coercion of cultural and academic circles. The objective: destroy Castro's hold on Cuba.

Results of the CIA's covert paramilitary actions against Cuba had not been encouraging. Principally a "cloak and dagger" intelligence-gathering organization, the CIA could not handle offensive combat operations, as was shown very clearly at the Bay of Pigs. The Standing Group decided to strengthen the Agency's paramilitary capability by providing two "advisers" from the regular U.S. armed forces, on an undercover basis.

Captain Ayers has now given an account of this mission in his hardcover book, The War That Never Was, published recently by the Bobbs-Merrill Company (and to be reviewed in the next issue of SOF). Portions of the following article (which will appear in two parts, in successive issues of SOF) are condensed from Captain Ayers' book.

I came well prepared to my assignment with the CIA, from a professional standpoint. As a Regular Army airborne infantry captain with prior enlisted experience, I had accumulated just about all the qualifications for my unconventional warfare mission. Ranger qualified, psy war, mountaineering, air-ground ops, specialized training with Special Forces,

command and staff assignment as a junior officer through regimental level, instructor-briefing officer experience at higher command echelons; at age 28, with ten years of active regular army duty behind me, I hadn't missed much. It was with this background that I enthusiastically embarked upon my undercover mission with the Agency.

After all, they were supposed to be the pros in clandestine paramilitary warfare. Drawing upon former OSS personnel and experience, the Agency had the best my country could put forth, I thought. Unlimited resources, latest techniques and skills, the most sophisticated equipment, the best in training and tactics, tops in organizational efficiency and operational planning. As the Eastern Airlines Electra touched down at Miami International I could scarcely repress my excitement.

However equipped I was professionally for my mission, I was not mentally prepared for what I found. It soon became apparent that my preconceptions and expectations were quite unrealistic. The first real jolt came when, shortly after my arrival in Miami, I was taken on a tour of CIA undercover training bases in the Florida Keys.

One of the "outside" agents¹ took me to the Homestead Marina, where I met Turk MacPhail. I'd already heard many stories about the tall, rawboned man and his daring escapades at the Bay of Pigs. Turk, in his mid-forties, was a contract employee of fairly long standing with the CIA and was held in high esteem by almost everyone. Like Dave, the chief of operations to whom he was directly responsible, he was said to be stubborn, independent, and jealously protective of his men, who, from what I had read and heard, performed well under his supervision.

Turk apparently had not been told about my military background. I had been instructed to use an operational (Paragon Air Service) cover, and Turk didn't ask any questions. As the tour began, Turk briefed me on the V-20 boats used in the commando strikes. Their 20-foot V-shaped hulls had been extensively modified and reinforced—at a cost of more than \$30,000 each. They were made of double-thick fiberglass to withstand the beating of high speeds on the open seas and to resist damage from coral and objects submerged in shallow water. Armor plating was embedded in the fiberglass to protect the fuel tanks and the occupants. Plastic foam and rubber, installed in critical places, added protection against bullets and afforded the crew some cushioning within the open cockpit. Equipped with twin "souped up" hundred-horsepower Greymarine inboard engines with retractable outdrives, the boats could travel 35 miles per hour while using no more than 75% of their full power.

I boarded one of the "sanitized" V-20s; that is, all suspicious-looking gear, such as machine-gun mounts, towing shackles, and special electronic equipment, had been removed or disguised so that the boat appeared to be a common pleasure fishing craft. Two wiry, dark-skinned young Cuban men climbed aboard dressed as fishermen. Turk ordered the operator to open up the boat full throttle as soon as we reached open water, and with that we were on our way.

I had brought a marine chart of lower Biscayne Bay and tracked our course from Homestead Marina to the west shore of Elliott Key. The water was very shallow—with jagged coral a few feet down—but we skimmed high over it, and the spray soaked our clothing. Turk told me that on the open sea, even on a calm day, the powerful boat skipped like a flat stone from the top of one swell to another, landing each time with a bone-jarring smack, only to launch itself in the air again. From the moment I saw the boat and felt it under me, I knew I wanted to handle one myself.

It took us about forty minutes to reach Elliott Key. We pulled into a small dock, partially concealed in the mangroves, near the center of the island. Two unshaven young Cubans met us there with a rusty old homemade car. One man stayed to guard the boat, and the rest of us piled into the makeshift vehicle. With Turk behind the wheel, we bumped over a narrow coral road through the mangroves and stopped in front of an isolated, ramshackle old house surrounded by palm trees and dense vegetation on the ocean side of the Key. Turk ex-

plained that this was the safehouse and base of operations for his commandos. The team lived and trained here and were allowed to go ashore to see their families and friends only once every week or two.

Turk showed us through the old building, which was set up like a military barracks. In the large kitchen, an elderly Cuban cook was busy over steaming pots that gave off spicy but appetizing odors. We proceeded to the equipment shed, and I saw that the group was well supplied with weapons, outboard motors, rubber boats, packs, green fatigue uniforms, and various military hardware. Turk pointed out that everything on the island could have been purchased in most civilian-military surplus stores; theoretically, therefore, the commandos' equipment could not be attributed to direct U.S. military support.

After lunch I went for a long walk on the beach. I saw no other dwellings or signs of civilization. Elliott Key was an ideal site for a training camp. Turk had said that the only intruders were weekend beachcombers and occasionally someone seeking help in a boating emergency. Aside from that, the only security problem lay in the island's logistical support: Everything—fuel, bottled gas for cooking, fresh water, food, and other supplies—had to be transported from the mainland, and I could see the difficulties involved in shipping without creating suspicion.

It was very peaceful in the old house that night. Limited electrical power was furnished by a noisy generator and the dim light was supplemented with old-fashioned gasoline lanterns. In one
(continued on page 60)

CIA also used converted oil rig "crew" boats like one shown right of center to transport infiltrators, weapons. Each boat was assigned a CIA case officer who was res-

ponsible for paying crew, coordinating logistics for operations. Case officers were not supposed to go on ops, but did so occasionally.

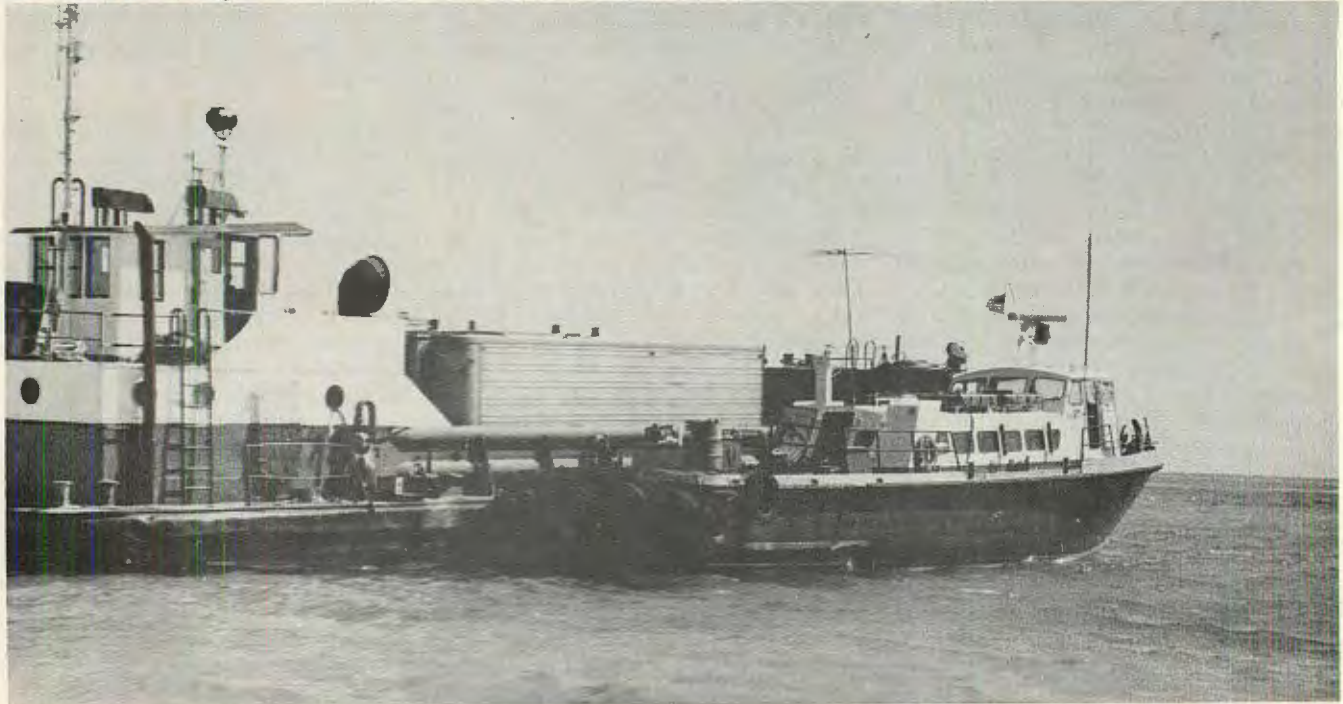

HIGH RISK/LOW PAY: FREELANCING IN CAMBODIA

BY DARYL TUCKER



Cambodia, 1974 — The Cambodian soldier in front of me flicked the selector switch on his M-16 to rock and roll and, kneeling, fired a burst toward a treeline about 100 meters away. His firing was the only sound. He didn't look more than 12 years old.

I was with two infantry squads, crouched in a dry paddy south of Phnom-Penh. The young rifleman let go with a couple more bursts and then eased back behind me, obviously scared.

An elderly lieutenant with a M-79 grenade launcher said something to the kid and motioned for him to move back up. He shook his head and replied in Cambodian, which I didn't understand. But I do understand "Fuck you, lieutenant" in any language.

The lieutenant slid a round in his grenade launcher and fired toward the treeline. He fired a few more, the rounds smacking into the trees.

As I was checking out my camera, the insurgents opened fire. When I looked around to see what the troops were doing, they were running to the rear like striped-assed apes. All I could see was assholes and elbows. One had even run out from under his helmet.

I leaped up and did a not-too-subtle imitation of the troops, as AK fire cracked, whined, and zinged around me. I caught up with the sprint commandos and threw myself behind a bladed parapet. Welcome to Cambodia. It was my third day in country.

And how did I find myself in this situation? A month after I was discharged from the army I bought a ticket for Saigon, to work in Vietnam or Cambodia as a free-lance photographer. I had spent two tours in Vietnam as an army photographer, and knew the country fairly well.

I had tried to get letters of accreditation in Oregon and California from weeklies and dailies, and from a newspaper I had worked for in Arizona, but was not successful.

A letter of accreditation would state that I might be submitting work to a

publication that recognized my professional status. With two or three letters, I would be able to obtain a press card in a foreign country and a work visa, which would enable me to stay beyond the time allowed for a tourist visa (usually 30 days or less).

The papers which I contacted denied me any support, generally for three reasons:

1. The editors didn't know me, didn't trust me, and were afraid I might run up bills in their names.

2. They preferred to get their stories and photos from the wire services and had no interest in any other sources.

3. S.E. Asia, at the time I wanted to go there (in 1970, and then again in 1974), was not considered big news as it was earlier in the war. Pack journalism decrees what is news and what isn't.

A couple of months before I got out of the army I wrote to the AP bureau chief in Saigon and asked about the possibility of free-lancing in Vietnam. He replied that it wasn't easy working in there at that time but he wouldn't try to discourage me totally.

Since there wasn't any work in Arizona or California, I figured it wouldn't be any worse in S.E. Asia. I had heard that Mike Hoare, the Congo mercenary colonel, was in Cambodia, and hiring. If journalism didn't pay I figured I could always fall back on merc work. As it turned out, he wasn't even in the country.

And so, after a flight through Hong Kong, there I was, back in fun city—Saigon. With all the GIs gone Tu Do Street was quiet. Most of the bars were closed or converted to restaurants. The Eden Roc was no more, but the Saigon Bar was still open. Naturally a girl asked, "Honey, you 'member me?"

The taxi girls were hungry and ready to follow somebody home for the price of a dinner. They had sad stories: "My boy-



Career hazards of a free-lance combat photographer are aptly illustrated as arty rounds impact. Author's camera was up and ready for this action shot.

3rd BDE troops of Cambodian Army, armed with AK-47s, leisurely survey artillery impacting on Khmer Rouge positions about 400 meters away, eight miles north of Phnom Penh.



friend fini Vietnam, no marry with me, souvenir me one baby-san."

A talk with the Saigon bureau chief convinced me that it wasn't easy to get a press card in Vietnam and that working in the country was difficult in the absence of the U.S. military and its accommodation, no matter how grudging, of the press.

A photographer was apt to be turned away at checkpoints before he could get to a possible story. Also, communist zones had been established, and it was possible to wander into one by mistake. The communists may or may not have minded but the ARVNs certainly did, and would arrest anyone re-entering their side.

The bureau chief suggested I try Cambodia, where things were much more casual. So a short flight on a DC-3 brought me to Phnom-Penh.

Cambodia, in April 1974, had a year before the fall of its government to the Khmer Rouge. To an observer in the field, however, a collapse seemed possible any day.

The insurgents controlled all major highways leading to Phnom-Penh and had moved their captured artillery close enough to shell the city and cause numerous civilian casualties. There was fighting a mile from Takhmau, a suburb to the south of Phnom-Penh. Government troops had been falling back a kilometer a day for almost two weeks and had recently left a large stockpile of 104mm artillery shells to the Khmer Rouge.

There was another front eight miles north of Phnom-Penh along Highway 5, and one to the southwest. The north and south fronts were only a few hundred yards wide, even when insurgent posi-

tions across the rivers were counted. The government position at Takhmau consisted of a perimeter around a shelled house by the road.

There were said to be 74 Khmer Rouge battalions of 300 men each in the Phnom-Penh area, yet little more than a battalion of government troops were engaged at each front. They were barely holding on when they weren't falling back.

In the miles of uncontested country north and west of the city life went on as usual.

The war was, to say the least, bizarre, as I would soon find out.

Since I was carrying material for AP and CBS in Phnom-Penh, it had been arranged for someone to meet me on my arrival. Chhay Born Lay, AP's number-two man, sped me through customs and drove me downtown. During my stay in the country he proved a real gentleman. I hope when things went to hell a year later he was able to get out.

Matt Franjola, the bureau chief, said he would grant me accreditation and that AP would supply me with film. They would return any negatives they didn't buy. A letter was typed up, acknowledging my status as a professional photographer.

That was the easy part. Getting a press card and a work visa through the government was a hassle. Bureaucrats are self-important morons anywhere, but were especially so in Cambodia. Mr. Cheng, the official I had to deal with at the Information Ministry, began by sending me to the Immigration Ministry for a form which he knew had to be supplied by his office. Of course, I was sent back.

M-60 machine gun crew fires at Khmer Rouge positions eight miles north of Phnom Penh several months prior to the fall of Cambodia. Large quantities of weapons utilized by friendly forces were abandoned or sold to Khmer Rouge by corrupt government officials.



And so it went—waiting, walking between ministries, being ignored by arrogant little bureaucrats, enduring the insolence of office. I wasted a couple of days a month, getting my visa renewed.

When I first got to Phnom-Penh I lived for a while in a warehouse hotel that had been recommended for its low rates—\$1.50 a day. For another dollar the toilet had a seat. Sometimes in the morning I could hear a whore retching in the hallway.

My room had an overhead fan that worked sometimes. Its walls were decayed yellow, the ceiling grimy pink. With only a weak fluorescent bulb for illumination, the room was never light enough. It was a hell of a place to have a fever in.

When I heard of a Brit who had a room to rent in a villa, I went to have a look. It was right next to the Defense Ministry. Since Phnom-Penh was often hit by artillery and 122mm rockets, the location was a bit downrange. But the room was only \$30 a month. Such a deal.

Groups of people often stood in the street, watching the house, either because they were paid to or from curiosity. Probably one guy was assigned by the police to keep an eye on us, and while he was standing there, another bunch would stop and stare too.

Cambodians loved to stare, just stand there with their mouths open. They especially liked to stare at Americans, and we could draw a crowd just by walking down the street.

In my case, it was suggested that since I looked so cadaverous because of my fevers, the crowds were waiting for me to drop so they could loot my body before I hit the ground.

One morning I noticed a particularly large group, staring at the house.

“Hey, Tony, look at this,” I called to one of the pilots who lived in the house. He walked out to the balcony, surveyed the situation, then bent over and pulled his pants down. Hare Khrishna! The street cleared as if he had thrown a grenade.

Another time a pretty girl in a police uniform sat outside the gate and kept looking up where I was reading on the balcony.

I went down to talk to her with my maid to interpret. The girl didn't speak a word of English but was quite interested in who I was and what I did. She asked if I was an American officer. I decided that if the police were going to ply me with women I was going to hold out as long as possible. After a while she said she had to go, and I never saw her again. Sorry, no James Bond-Kissy Suzuki stuff.

The room I had rented was unfurnished, and after sleeping on the floor for a week, I decided to buy a bed. John, my British landlord, knew of a shop near the central market, so we hopped on his Lambretta motor scooter and went shopping. I saw a bed I wanted, paid about 10 dollars for it, and we loaded it on a cyclo. John wanted to look at some other stuff.

“Uh, John, the cyclo driver is peddling away.”

“No sweat, Mate, we'll catch up with him.”

The cyclo driver went around a corner, pedalling like crazy, with the double-wide bamboo bed in the passenger seat. By the time I got the Brit on his scooter and moving, the cyclo, driver, and bed were gone. The bastard had stolen my bed.

Two, and then later three, American pilots lived in the house. They were part of a colony of adventurers who flew 30-year-old DC-3 cargo planes in a combat zone for \$600 to \$900 a month, flying supplies and troops into beleaguered cities like Battambang and Kampot.

They were ex-CIA, ex-Air Force, ex-Marine, ex- a lot of things. I never asked too many questions, just let them tell me what they wanted.

They hung out at the Khmera Cafe on Monivong Street, a real hole, with a certain depraved style, like an elderly prostitute who used to have some class. The pilots liked to stomp and holler, and their vitality horrified effete Cambodians and French.

I was walking along the street one morning, when a pilot told me I had just missed a good show at the Khmera. Three Cambodian soldiers had walked in, one with an empty sleeve, one with a leg missing, and a third with his very own hand grenade. He had a finger in the pin. They wanted some food and they got service in a hurry. The pilot said he was crouched for one hell of a sprint to the door.

Never a dull moment at the Khmera. Usually there were hot-eyed women, quite pretty ones, of mercenary graces. Occasionally a waiter would slither up to one's table and whisper, “Monsieur, can change money?”

If a customer needed some *Riel* (Cambodian currency) and the black-market price was right, a transaction would be made by hands transferring funds under the table. I tried to time my transactions after the government had



A Cambodian soldier under fire happily poses for the camera during a stand down.

A 12-year-old Cambodian soldier points toward elements of the enemy force about 100 meters away. "Beau-coup VC." Children were used as soldiers on both sides.



lost another battle, so the rate would be higher.

I never saw journalists in the field, just photographers. A journalist can do his stories in a hotel room, but a combat photographer must go where the action is.

The Cambodian photographers in particular did excellent work, of great power and poetry, at considerable risk. In a two-month period, six of eight photographers working out of the AP office were wounded. A few months after I left, Lim Saveth, a fine photographer who was always in the middle of a firefight, was killed near Kompong Chang.

AP told us they couldn't guarantee medical expenses if we were shot up, as several photographers had already been. And also, "please don't use up so much film." AP and UPI graciously paid their Vietnamese and Cambodian staff photographers about \$30 a month.

Combat photographers operate as staff or free-lance photographers or stringers. In Cambodia a stringer received \$3 a day in the field plus cash for any negatives sold. A free-lancer is paid by the negative. 1974 prices in Cambodia were \$20 per negative. If you could sell two or three negatives a week, it was possible to live in Phnom-Penh, especially if you were an accomplished moocher. In the 10 weeks I was in Cambodia I sold one whole picture.

While the photographers were helpful and friendly, the journalists generally weren't, perhaps fearing competition, or seeing photographers as a bit below their station. They could usually be seen lolly-gagging around the pool at the Hotel le Phnom or sipping Cambodian coffee of half sweetened-condensed milk, half coffee at the Information Ministry (also known as the Ministry of Truth). The ministry never had any information of worth.

No journalist ever offered to show me the things I needed to know in order to

survive or work efficiently, such as where the fronts were, which units were liable to take a powder under fire, or if the insurgents had just cut a road. I had to wander around on my own to find out where everything was and how things were run.

I learned to watch what I said around journalists. Since stories are their trade, often obtained second-hand, an ordinary recounting of a day's adventures can give a journalist something to run with. I once joked that it would be amusing if an American were able to pose as a U.S. Army officer and get an attack going, so naturally it got around that I had been passing myself off as an officer.

I learned that the war ended every day at five in the afternoon, a phenomenon I observed numerous times north of Phnom-Penh. Each day, Cambodian government armored personnel carriers gave covering fire to infantry as they pulled back from skirmish positions. The recoilless rifle on an APC was armed and fired point blank at Khmer Rouge positions about 200 meters away. Muzzle flame flashed against smoke, and ringing pillars of dust from impacting mortar shells burst among the vehicles. Communist Kalashnikov AK-47 rounds zinged through the leaves of the trees, and ricochets whined low over the dry paddies.

When the APCs had pulled back far enough, the infantry climbed on board and the battalion rumbled and clanked back to 3rd Brigade headquarters for the night, leaving a few people behind to hold the line; the communists obligingly stayed where they were. Next morning they'd be at it again, standing there blasting away at each other.

This had been going on for several weeks. The front about eight miles north of Phnom-Penh was about 300 meters wide where the 7th Brigade was in contact with a Khmer Rouge unit about the size of a company, some 60 to 100 men. The APCs (M-113s) could have turned the enemy flank in a minute or two, but their commander wasn't aggressive enough.

One Sunday when I had a fever, a government battalion, under the five-o'clock-quitting-time ruse, pulled back, and then made a flank attack that rolled the communists back two kilometers.

Next morning there wasn't much to see—cratered earth, burnt trees, and Khmer Rouge dead sprawled here and there, as if some Grendel had torn them apart and flung them to the ground. The bodies were close to the bunkers, a few still in them, and flies buzzed drunkenly. It was doubtful that many prisoners had been taken, since that was not the custom.

On a similar occasion all surviving wounded had been shot. All of them. Moving grass gave away a wounded man trying to crawl to safety. A kid with a lemon grenade ran over and threw it at him. He was on his knees, covered with blood, his hands together in supplication, when it went off in his face.

There were a number of children among the dead. A 12-year-old soldier floated face up in a flooded shell hole. Using children for soldiers was also a custom of the country. Another custom was to cut the liver from a dead enemy and eat it, but there did not seem to be any mutilations of that sort.

No papers or weapons lay around. Everything but the bodies had been po-



Members of Cambodia's 3rd BDE react as hostile fire rudely interrupts a smoke break in the war. Note the M-79, M-16, and, in the background, the APC with mounted .50 cal. machine guns.

liced up, and a few days later they were dumped in a hole somewhere.

The small U-shaped bunkers were barely large enough for two short men. Lightly covered, they could not withstand a direct hit from 105mm artillery or even a heavy mortar. Those hit were usually near a prominent terrain feature such as a small stand of trees that gunners could use for a target fix.

These Vietnamese-designed bunkers were carefully built into the low paddy walls without disturbing their contours. Because there were no firing slits, defenders had to rise from bunker entrances to fire their weapons. Due to a slight rise of elevation behind them, they did not present silhouettes.

A Phnom Penh bar girl strikes a pose and smiles happily despite the desperate war situation. After the Khmer Rouge takeover, girls of her occupation were systematically annihilated along with over 1½ million Cambodians.



Since the paddies sloped gradually, the bunkers looked down on government positions. About 30 meters apart, they were usually dug in against the corner of two paddy walls. The communists were better concealed in an open field by this effective use of terrain than were government troops, who occupied a tree line.

From these bunkers, the Khmer Rouge had held off a superior, mechanized force for days, enduring constant artillery barrage before dying at their positions when finally overrun.

Since the government fought from the road, and road interdictions are easy missions, it made no sense for these lightly armed troops to make themselves static targets for artillery and armored vehicles. All they had to do was shoot up a truck once in a while to block a road for days. They could have pulled back any time, or attacked the 3rd Brigade's lightly held nocturnal positions. Instead they dug in. A rearguard holding action was a possible explanation, but stupidity was equally probable.

Khmer Rouge positions should have been attacked before there was time to build bunkers. Finding the enemy was no problem in Cambodia. That's what bothered government officers. They may have been more stupid than cowardly, but their cowardice was considerable. All they could do was line up their troops as if they were on police call and let them blast away, hoping they wouldn't have to close with the enemy.

Officers were stupid and cowardly because the feudal ruling class that produced them was enervated and degenerate. Competent soldiers could not become officers without the proper social background. Since social mobility did not exist in the culture, it could not exist in the army. As in Vietnam, the army could not be changed and made effective without first changing Cambodian society, something the United States couldn't do, and had no business trying.

How many Ph.D.s does it take, asked I.F. Stone, to figure out that we can't win a war in a peasant country on the side of the landlords?

Government officers were trying to compete with an insurgent cadre recruited from the peasantry and promoted because they could fight, rather than for loyalty. They often did dumb things but didn't lack for courage. Light infantry armed with AK-47s, some rockets and mortars, had held off a mechanized brigade supported by 105mm artillery and occasional air strikes. The unit was probably an understrength company, for I counted about 30 two-man bunkers. Their low rate of fire indicated insufficient ammunition supplies, something the government brigade commander confirmed.

Yet when the insurgents were finally overrun they died at their positions.

Government enlisted men could hold a line too and frequently displayed the qualities of good soldiers, but they were often hungry and lacked motivation. Lack of motivation was understandable in the absence of leadership and a positive cause. Frequent examples of poor morale and discipline, especially fire discipline, were indictments of government leadership.

Soldiers were often hungry because they were paid through their battalion commanders, who had a habit of pocketing their pay. They also appropriated the pay of missing soldiers, as well as the death benefits, a year's pay, of soldiers killed in action.

When soldiers did get their pay it was only eight dollars a month. An Australian mercenary who had fought with the 3rd Brigade told me he was paid eight dollars for three months.

It wasn't unusual for officers to be blown away by bitter soldiers. When a finance officer showed up empty-handed at a unit that had not been paid for three months, he was shot and eaten, chomp, chomp.

An infantryman's life is short, nasty, and brutish enough without the callous disregard of his government. Many soldiers simply gave up, as did the entire 3rd Brigade toward the end of the war. They sold their weapons on the black market for dope and booze, and tried to forget about the mess. In 1974 M-16s were selling for \$15 apiece. Everything else was for sale, too, up to and including M-113s.

Cambodian officials were involved with Vietnamese naval officers in the heroin traffic. American aid for refugees was stolen by officials, and I saw American-aid rice being unloaded at the Information Ministry, and distributed among officials, as Mr. Cheng supervised.

A *New York Times* article by Sidney Schanberg catalogued the sale of 105mm artillery shells, rice, gas, and medicine to the Khmer Rouge by government officials. It was believed that many shells that fell on Phnom-Penh, killing and wounding nearly 1000 people, had been supplied to the insurgents by corrupt officials.

Inability to adapt or to accept new ideas to meet changing conditions were also factors in Cambodia's defeat. I was personally involved in an incident that illustrates government narrow-mindedness. I had never seen a spotter plane in use to locate enemy positions and direct artillery fire. An observer with a camera in a spotter plane could easily pinpoint the location and number of Kmer Rouge bunkers. Communist bunkers, while difficult to see on the ground from only 30 meters distance, were easy to find from the air because their entrances stood out dark against the lighter paddies.

An 8x10 print from a 35mm negative shot at a low altitude (1200 feet) is easily understood without special training. Cambodian commanders could carry prints with them in the field and know exactly where all bunkers were. Since they couldn't make a move without three weeks of artillery preparation, at least their fire could be directed accurately, knocking off insurgent bunkers one at a time.

I decided to offer my services as a spotter photographer to the Cambodian government. The problem was making the right contact. I made an offer to a field commander, but he wasn't interested, even though he was under fire from the bunkers I'd been speaking of.

I wouldn't get beyond the first clerk at the Defense Ministry, so I went to see Cheng. Although he was a bastard, I reasoned that he would be able to pass my idea on to the right official, if there was a right official. My usefulness to the government would also facilitate my visa extensions. Cheng ranked just below the Minister of Information, so was hardly a clerk. He had gone to school

at UCLA and spoke excellent English, so there would be no communication problem.

He couldn't be bothered. I should go to another ministry, he said.

I realized then that these people were so enervated that their instinct to survive was gone. The ruling class lacked aggressiveness, the ability to adapt to changing conditions, or to adopt innovations. Only greed was left, and the compulsion to steal, like one last shudder and gasp.

Other indications of social and military decay became apparent during a reconnaissance my British landlord and I made on his scooter. The AP Bureau chief had heard of insurgent infiltration northwest of the city and asked me to look into it.

We were ringdingding down the dike road that ran west from Highway 5, made a turn, and suddenly found ourselves in the midst of unfriendly troops who wore bits and pieces of different uniforms and civilian clothing, and were armed primarily with AK-47s.

"Uh oh, Mate, it looks like the bad guys."

"Uh. Well. Let's get the fuck out of here."

"Too late. Smile."

So we smiled at the nice people. Hi. How ya doin'? Suddenly the platoon leader turned his men around and marched them back down the road.

They weren't bad guys after all, but they weren't quite good guys either, and their officer certainly didn't want to talk to us.

They were third-rate provincial troops, and it wasn't hard to figure out a deal had probably been made with the insurgents. They wouldn't hassle the Khmer Rouge and the Khmer Rouge wouldn't hassle them, a common S.E. Asian arrangement. Their stroll down the road was just for appearances.

Open country stretched mile after mile. Government stockades were few and far between, and except for the phony patrol there was no military activity at all.

We came to a small compound of provisional troops. There were no officers present. The commander was "downtown."

The Brit, who spoke the language, asked them about insurgent activity. It was all very quiet, they said. No VC. A young man in the back row blurted that there had been VC moving south last night. He was poked in the ribs to shut him up.

Another gut-feeling situation that said they let the insurgents operate all around them.

We motored on through a small town and then out into the country again. Loose, deep soil in the road made it difficult to keep the scooter upright.

Up ahead a soldier with an empty pants leg struggled along on crutches, accompanied by a woman and child. We pulled over to rest and gave the man a pack of

Salems. They were real nice people. As they continued down the road, they kept turning around to wave and smile.

I wanted a picture but didn't want to invade their privacy, since they had little else left. I wasn't able to get a shot, but I can still see them on that long, hot road that seemed to lead nowhere, a symbol of the senseless waste and tragedy of that wretched land. I felt an obligation to be a witness, and to never never forget.

Only a few days were quiet when I was in the field. There was usually a firefight going on, but that didn't mean there were decent photo opportunities. Since the opposing lines were only 200 to 300 meters apart, to be shelled and shot at was an everyday thing.

To reach the government position south of Takhmau, for example, a photographer had to evade insurgent fire from across the Bassac River, as well as south and west of the perimeter. A psychotic with an AK kept trying to grease me, and I had to scurry through the bushes like a wombat. The snipers almost always fired too high, but I'm not complaining.

Fire from M-79s and mortars was often more accurate. I was told that M-79s accounted for at least 40% of the casualties. Down the road from me one day, Al Rockoff, a stringer for AP, and another



A Cambodian with M-60 during advance toward Wat Khvos, a rural area near Phnom Penh. Often the equipment carried equalled or exceeded a soldier's body weight.

photographer were wounded by M-79 grenade fire. Rockoff spent a couple of weeks in a Bangkok hospital. When he came back, he said I was next.

I wasn't next, because Cambodian germs did me in before the bad guys could get the right windage. I had been feeling the effects of a lingering flu when I left the States and had little resistance to contaminated food and water in Phnom-Penh, although I had never been sick in a foreign city before. From the beginning I had fevers that made my ears ring and that drained me of energy. Some days I could barely get out of bed, much less stagger around rice paddies. The next time I work in a foreign country with dubious sanitation I'll start taking pills as soon as I get there.

Trying to work sick got harder and harder. One day after a particularly long walk to a firefight in 110 degree weather, and a run across a fireswept field, where mortars were being walked up and down the line, a shell impacted a few feet in front of me.

My face was in the dirt at the time, dirt smelling suspiciously of stale urine, but the grenadier beside me was kneeling to fire. He was hit in the shoulder, face, and chest.

I motioned to the wounded man's buddy to pick up his gear. Just as the firing intensified after a comparative lull, and before I could help him up, the grenadier staggered a few paces toward the rear and fell to his knees.

I jerked him up, and we managed to make it across the field. It was a good walk to an APC that took him down the road to an ambulance jeep. By the time he was on his way to a hospital I could barely stand, and there were a couple of miles yet to a crossroads where I could get a ride to the city. After I had shuffled a mile or so, a Cambodian UPI photographer gave me a ride on his Honda.

I worked the next day, but after that I'd had it physically and financially. A pilot I knew arranged a free flight for me to Battambang. From there I took a taxi to the Thai border and then a bus to Bangkok. My return to S.E. Asia had lasted three months, not too much compared with two years in Vietnam.

My next expedition will be better funded, and I will be in much better shape. With a degree in geography and journalism, I am better prepared to record my observations and experiences.

I recommend free-lance writing and photography as a ticket to adventure, but expect to pay your own way, and have as much background as possible. Cultural geography and land use are especially helpful in analyzing conditions in a country.

Have a lot of money in the bank, don't get sick, don't get shot, don't expect to make any money. Nothing to it. Have fun!



SILENT DEATH IN VIETNAM

BY LTC. ROBERT K. BROWN





Above: Maj. Willis Powell, commander of first Army sniper team sent to Vietnam in 1968, shows Brig. Gen. Timothy the MAW-A-4.M14. In five months Army snipers zapped 1245 VC, expending 1.37 rounds per kill.



Mitch WerBell carries the M-16 sniper unit with Sionics Corp. suppressor and night-seeing device used in Vietnam.

Pitch black night was once again descending over the fertile, rice-producing Mekong Delta in Vietnam. As darkness moved in, it was time for Victor Charlie to move out. But tonight, the lack of visibility was to prove no friend to the VC unit operating in the area, ambushed by a small element of Company D, 3/60th Infantry, 9th Division.

Six battle-hardened GIs in camouflaged fatigues positioned themselves along a treeline near a small muddy canal bordering a large rice paddy. The ambush location offered excellent fields of fire and observation of the paddy area and a road which crossed the paddy at a forty-five degree angle. Once situated and concealed, the ambush party did not have long to wait.

At 1950 hours (7:50 P.M.), as dusk closed in, three heavily armed VC were observed humping down the road in an unconcerned manner about 400 meters away. In a matter of seconds, the three VC crumpled into grotesque positions of death in the red dirt. Shortly thereafter, a single VC emerged from a nearby banana grove. He suddenly pitched forward — dead. Two hours later, another VC peered cautiously from the woodline, attempting to determine what had happened. As he attempted to retrieve the weapon and web gear from his dead comrade, he collapsed — dead.

Within an hour, another party of half-a-dozen VC moved across the rice paddy from the left of the ambush party, their

deadly AK-47s at the ready. The VC point man's head exploded in a red mist and he slipped below the paddy water. The remaining VC, terrified because they had heard no noise, sought cover. In a few minutes they double-timed away from the dead VC. One after another, they all died, quickly and silently. At 2315, two more VC were observed moving parallel to the road and they died — just as quickly and just as silently. Another Charlie stopped rapidly through the rice paddy. He died too. The "Silent Death" had struck again.

Eleven VC killed in three hours at an average range of 400 meters, and no noise! Did the ambush party have some fantastic new guided missile or laser beam? Negative. But they had something just as effective. A two-man sniper team armed with an accurized M-14, shooting match grade ammo, a noise suppressor (more commonly known as a "silencer") and a Starlight scope. And the sniper credited with the 11 kills proved once again that there is nothing quite as effective as well-aimed fire for economy and results.

Since the beginning of our Army, individual marksmen have played an important part in contributing to our battlefield successes over years. The significance of the potential effectiveness of skilled marksmen was first impressed on European powers when General Braddock's red-coated regulars were thoroughly decimated by French troops

and their Indian allies during the French and Indian Wars. Only the American frontiersmen, led by Colonel Washington, were able to prevent the defeat from becoming a total rout.

During the American Revolution, the American sharpshooter, clad in buckskin and wreaking havoc with his long-barreled Kentucky rifle contributed greatly to the defeat of the English and their Prussian mercenaries. In fact, it was one of these gimlet-eyed woodsmen that directly affected the battle which led to the final British defeat at Saratoga.

Shortly before the Battle of Saratoga, a large unit of British infantry, led by General Frazer, who was considered one of the most effective officers in the British Army, was attacked by American forces commanded by the famed General Daniel Morgan. The British line was broken shortly after the initial engagement and General Frazer began reorganizing his forces.

Morgan observed General Frazer, astride his horse, directing the regrouping. Morgan sent for one of the most widely known of the famed "Morgan Riflemen," Tim Murphy, and directed him to bring down Frazer. Murphy's third shot tumbled Frazer off his horse with a mortal wound. The resulting confusion among the British unit enabled Morgan's forces to encircle the British and launch a successful attack from the rear. The loss of this position forced Burgoyne to retreat to Saratoga, where he was eventually forced to surrender.

The skills and courage of individual riflemen continued to prove of immense value to the United States throughout numerous conflicts. However, since World War II, the military has placed emphasis on volume of fire and fancy gadgets rather than the well-aimed shot. Generally speaking, this was especially true in the Vietnam conflict.

The Army Sniper Program in Southeast Asia was initiated in late 1967 when General Ewell learned he was to assume command of the famed Ninth Infantry Division in Vietnam. General Ewell believed that snipers could operate effectively in this area, inasmuch as large portions of the Ninth Division's area of operations contained wide expanses of flat, cleared terrain and rice paddies. He felt there still might be a place for the individual rifleman equipped with accurate rifles and possessing patience, stamina, judgment, courage and an eagle eye. General Ewell contacted the Army Marksmanship Training Unit (AMTU), which heretofore had been primarily concerned with developing champion competition marksmen, at Fort Benning, Georgia, and asked them if they could develop a program for training snipers for the Ninth Division.

Members of the AMTU, all of whom had had extensive rifle competition experience, enthusiastically embraced the challenge as they were anxious to



Members of 5th Special Forces Group in Vietnam familiarize themselves with M-16 sniper unit. Was used for prisoner snatches, covert ops.

demonstrate that pinpoint marksmanship could make a contribution in modern warfare as well as punch the "X" ring out of a target. While developing a Program Of Instruction (POI) for sniper training, AMTU members conducted extensive tests to determine the weapon that would best meet their requirements. The M-14, highly accurized in their own shops with glass-bedded stocks, match sights, star-gauged barrels, etc., was finally selected.

The Redfield scope company was contacted to build a number of their 3 x 9 variable scopes with a special cross hair and stadia marks. This special Redfield scope was then married up with a special mount and a ballistic cam system developed by Captain Jim Leatherwood. This sighting system was then designated as the Automatic Ranging Telescope (ART). The mounts were designed to allow the interchanging of the ART and Starlight Scope on the same rifle, without affecting the zero of the weapon. Consequently, a sniper can utilize the same rifle in both day and night without any adjustments as long as he has both scopes with him.

Early in 1969, a "silencer" (more accurately described as a "noise suppressor") was added to the accurized M-14 and ART. The "silencer," (developed and patented by Mitchell L. WerBell III, a former OSS officer and long-time soldier of fortune and manufactured by the Sionics Corporation which was absorbed into the now defunct Military Armaments Corporation) reduced the noise level of the muzzle blast to the extent that beyond 100 meters, it was impossible to determine where the shot originated from. Furthermore, the "silencer" or "noise suppressor" completely eliminated muzzle flash, which proved especially valuable during night ambushes.

The "suppressor" increased the capability of sniper personnel, as it gave them confidence to take targets under fire that they would have normally ignored for fear of revealing their location. It was found that the suppressor made by Sionics, as contrasted to other models under consideration, affected neither the range nor the accuracy of the sniper's fire.

The original sniper instruction team assigned to Vietnam consisted of one officer and eight non-commissioned officers, one of whom was a trained gunsmith. Because of the sophistication of the sniper weapons and need for minute-of-angle accuracy, the gunsmith was as important, if not more so, than any other single man on the team.

The individual sniper was to perform only the most basic maintenance on his weapon, including cleaning. About once a month, each sniper returned to the sniper school where his weapon received a zero check and thorough cleaning. At this time, members of the original sniper instruction team determined how the equipment was performing, what problems the sniper encountered and if the sniper was being utilized properly.

One of the main problems the sniper program faced was the mis-utilization of sniper team personnel. Several snipers were wounded because they were walking point, providing rear security or assaulting a fortified position. Many small unit commanders attempted to get sniper personnel transferred into slots where they would serve as squad leaders or platoon sergeants. Company and Battalion Commanders, who were not familiar with the sniper's capabilities, were aware, however, that said personnel were highly-trained, motivated and competent in a wide variety of military subjects and, furthermore, had extensive combat experience.

When the first sniper instruction team arrived in Vietnam in June 1968, they found that they would have to build their own range and instruction facilities. At that time, the only accurized M-14s with ARTs were the ones brought by the instruction team from Ft. Benning.

While the range was under construction, the instructors themselves operated as snipers with units in the field, in order to determine what problems their future students would have to cope with and to familiarize small unit commanders with their unique capabilities. Concurrently, they also organized a familiarization and



An Australian officer tries his hand with the suppressed M-16 at demonstration near Saigon in 1969.

zeroing program on the M-16 for replacements coming into the Ninth Division.

Sixty-five of the accurized M-14s and sophisticated scopes arrived in Vietnam in late October 1969 and the snipers began dealing large doses of "silent death" to the unsuspecting Viet Cong and North Vietnamese regulars.

In selecting students to participate in the sniper school, it was determined that a man should have at least three months' combat experience with a field unit, that he should have at least six months remaining in Viet Nam and above all, that he must volunteer for the program. Initially, unit commanders sent men to the school who were not volunteers — who had no idea why they were there or for what. These individuals were quickly identified and returned to their units.

The sniper school lasted 18 days and started with a review of basic marksmanship fundamentals, such as positions, use of slings, reading and holdoff for wind, care and maintenance of the weapon plus other related subjects such as target detection, map reading, land navigation, camouflage, tactics, adjusting artillery, etc.

On the average, only 48% of a 30-man class was graduated. Some dropped out because they were not willing to put forth the necessary effort; others, when it became apparent they could not shoot accurately and consistently. It was possible to score 360 points in the two field firing courses. The wash out score was 320 and no exceptions were made for those who failed to make it.

Tactical employment of snipers varied. Trial and error, coupled with flexibility, allowed the sniper units to develop their

own particular brand of tactics that produced the most kills. Initially, sniper teams were employed with Intelligence Squads and with Battalion blocking forces but with little success. Then sniper teams were inserted with company-size units on the evening resupply chopper. This tactic produced good results until the VC wised up and began giving company-size units a wide berth. Eventually the sniper teams found the most effective tactic was to work on their own with a four-man security element. This was the tactic used to kill the 11 VC noted earlier.

In any case, results proved that the tactics selected worked and that there still is a place in modern warfare for an accurate shot. From January 7 to July 24, 1969, for instance, U.S. Army snipers in Vietnam accounted for 1245 VC, expending an average of 1.37 rounds per kill!

One of the unsung heroes of the Vietnam conflict is the sniper who accounted for the 11 VC mentioned above. He is Sfc Alderbert F. Waldron (Ret.), who during his tour as an Army sniper was credited with 113 confirmed VC kills and ten blood trails. And in only eight months!

Waldron, who was one of the first snipers graduated from the new sniper school, found that, initially, he spent as much time selling his program to skeptical commanders as he did killing VC.

For his first six missions, he lay on the floor of a Huey chopper, scanning the countryside through his Starlite scope for wandering VC. When he picked up a VC, who thought he was safe in the dark, Waldron would fire tracers to direct the gunship to the target. Finally, he started operating with small ambush parties and

as his body count grew, he was dubbed with the code name, "Daniel Boone." On one occasion, he dispatched a nine-man VC column, working from rear to the front. With his weapon silenced, the VC were unaware that they were being eliminated one by one.

Below are a few after-action reports describing the activities of Sfc. Alderbert F. Waldron (Ret.):

Sergeant Waldron and his partner occupied a night ambush position with Company A, 3/60th Infantry on 25 January 1969, approximately four kilometers southeast of Mo Cay (XS 502178). The area selected for the ambush was along a dike adjacent to a rice paddy. The configuration of the terrain was such that a firing platform had to be improvised from C-ration boxes in order to provide clearance over the paddy dike. After the sniper position was completed, nippa leaves were used to conceal the team. At 1910 hours, two Viet Cong moved from right to left across the edge of the paddy and Sergeant Waldron engaged both, resulting in two Viet Cong killed. A half hour later, three more Viet Cong crossed the same area and Sergeant Waldron took them under fire, resulting in three more Viet Cong killed. The next contact took place at 2232 hours, when one Viet Cong returned across the paddy, apparently in an attempt to extract the weapons or bodies of the fallen. Sergeant Waldron subsequently engaged and killed this Viet Cong. The final contact of the night came at 2355 hours. A single Viet Cong came out into the paddy, was taken under fire, and killed. A total of seven enemy soldiers were killed at an average range of 350 meters with a total of seven rounds having been fired.

Sergeant Waldron and his partner occupied a night ambush position with Company D, 3/60th Infantry on 22 January 1969, approximately seven kilometers south of Mo Cay (XS 480128). The night ambush sight was along a treeline near a small canal, bordering a large rice paddy. The snipers' position offered them very good fields of fire, including excellent observation of a road which crossed the paddy at a forty-five degree angle. At 1950 hours, three Viet Cong were observed walking down the road, and they were taken under fire by Sergeant Waldron and his partner, resulting in three Viet Cong killed. Only one of these kills was credited to Sergeant Waldron. Shortly thereafter, a lone Viet Cong came out of a banana grove and was taken under fire by Sergeant Waldron, resulting in one Viet Cong killed. The next contact took place at 2100 hours when one Viet Cong appeared from the woodline, attempting to retrieve the weapon and web gear from the fallen body. The Viet Cong came out of a banana grove and was taken under fire by Sergeant Waldron, resulting in one Viet Cong killed. The next contact took place

at 2100 hours when one Viet Cong appeared from the woodline, attempting to retrieve the weapon and web gear from the fallen body. The Viet Cong was taken under fire by Sergeant Waldron, resulting in one Viet Cong killed. Within an hour, a group of five or six Viet Cong began moving across the rice paddy from the sniper's left. Sergeant Waldron took the group under fire, killing one Viet Cong and causing the others to drop to the ground. After a few minutes, the entire group got up and continued moving and were subsequently engaged one at a time until a total of five Viet Cong were killed. The next contact took place at 2315 hours, when two Viet Cong were observed moving near the road. They were immediately engaged by Sergeant Waldron, resulting in two Viet Cong killed. Approximately ten minutes later, Sergeant Waldron's position began receiving probing fire from an AK-47. Continuing to scan the area with his starlight scope, Sergeant Waldron spotted one Viet Cong running across the rice paddy and he was immediately engaged by Sergeant Waldron, resulting in one Viet Cong killed. The probing fire continued and therefore the sniper team moved to an alternate position for the remainder of the night. A total of eleven kills were credited to Sergeant Waldron for the night.

Sergeant Waldron and his partner occupied a night ambush with Company B, 3rd Battalion, 60th Infantry on 30 January 1969, northeast of Ben Tre (XS 528351). The area selected for the ambush was an intersection of two dikes surrounding a large rice paddy. The fact that the rice had recently been cut provided the snipers with good fields of fire and enabled them to use a prone position. Just before dark, two or three individuals were sighted moving towards a nearby village. Curfew was not in effect at that time and therefore the individuals were not fired upon. At approximately 2000 hours, one Viet Cong was observed moving near a treeline forward of the snipers' position and a request for artillery fire was called in. The request was denied since the area was considered populated. Sergeant Waldron observed the Viet Cong again and engaged him, resulting in one Viet Cong killed. The next contact took place at 2040 hours, when sixteen Viet Cong were observed moving in a line across the edge of the rice paddy. Sergeant Waldron took the first VC under fire resulting in one Viet Cong killed. The remainder of the group immediately hit the ground. Five minutes later, the group got up and resumed moving, *apparently not sure of what had happened*. Sergeant Waldron engaged and killed one more Viet Cong, causing the remaining Viet Cong to panic and start running towards the ambush position. *They apparently thought the fire was coming from the woodline*. Sergeant Waldron subsequently engaged and killed five more Viet Cong, bringing to

eight, the total number of Viet Cong killed during the night. Eight rounds were fired in obtaining these kills at an average of 500 meters.

Sergeant Waldron and his partner occupied a night ambush with Company D, 3rd Battalion, 60th Infantry on 3 February 1969, approximately three kilometers south of Ben Tre (XS 518281). The area selected for the ambush was in a large rice paddy bordered by a wooded area. At 2109 hours, five Viet Cong moved from the woodline to the edge of the rice paddy and the first Viet Cong in the group was taken by Sergeant Waldron. The first shot missed the target, necessitating that Sergeant Waldron readjust his starlight scope. The missed target prompted his partner to comment, "You missed that one, didn't you." After necessary adjustments were made, Sergeant Waldron again engaged the first Viet Cong in the group, resulting in one Viet Cong killed. Immediately the other Viet Cong formed a huddle around the fallen body, *apparently not quite sure of what had taken place*. Sergeant Waldron continued engaging the Viet Cong one by one until a total of five Viet Cong were killed. The next contact took place at 2225 hours, when one Viet Cong returned across the rice paddy, apparently looking for equipment and weapons near the bodies of the fallen Viet Cong. Sergeant Waldron took him under fire, resulting in one Viet Cong killed, bringing to six the number of Viet Cong killed during the night.

Sergeant Waldron and his partner occupied a night ambush position with Company D, 3/60th Infantry on 4 February 1969, approximately three kilo-

meters south of Ben Tre (XS 527283). The area selected for the ambush was at the end of a large rice paddy adjacent to a wooded area. Company D, 3/60th Infantry, had conducted a MEDCAP and ICAP in a nearby hamlet during the day, hoping to gain information on Viet Cong movements in the area. At approximately 2105 hours, five Viet Cong moved from the wooded area toward Sergeant Waldron's position and he took the first one in the group under fire, resulting in one Viet Cong killed. The remaining Viet Cong immediately dropped to the ground and did not move for several minutes. A short time later four Viet Cong stood up and began moving again, *apparently not aware of the fact they were being fired upon from the rice paddy*. Sergeant Waldron took the four Viet Cong under fire, resulting in four Viet Cong killed. The next contact took place at 2345 hours, when four Viet Cong moved into the rice paddy from the left of Sergeant Waldron's ambush position. The Viet Cong were taken under fire by Sergeant Waldron, resulting in four Viet Cong killed. A total of nine enemy soldiers were killed during the night at an average range of 400 meters. Sergeant Waldron used a starlight scope and *noise suppressor* on his match grade M-14 rifle in obtaining these kills.

As his body count rose, so did his fame — both among American units and the enemy. Victor Charlie quickly tired of Waldron's game rules and put a \$50,000 price on his head — dead or alive. Once American intelligence found out about the price on Waldron's head, he was hustled out of the land of rice paddies and "silent death" in 12 hours!

(continued on page 70)

Sixty-five accurized M-14s, with suppressors and Adjustable Ranging Scopes (developed by SOFer Jim Leatherwood) arrived in Nam in Oct. 1968.





1. Now the World's Greatest Military, Hunting, and Outdoors SWEATER at a great price from the good guys at **LANCER MILITARIA**. Original Issue, Brand New British Military Pullover Sweaters in Commando Green. 100% Virgin Wool with matching cotton and polyester blend twill patches on elbows and shoulders. Specify **Small, Medium, Large, or Extra Large, only \$29⁹⁵ Postpaid.**

OTHER MILITARY GOODIES

- 2. British Regimental Issue Berets in Airborne Maroon, Commando Green, Infantry Blue, or SAS Sand (*State your size*) **\$12⁰⁰ each, two for \$22⁰⁰.**
- 3. Anodized Badges for SAS or Parachute Regiment **\$4²⁵ each.**
- 4. SAS or Parachute Regiment Stable Belts with Regimental Buckle **\$25⁰⁰ each.**
- 5. SAS Cloth Wings **\$3⁹⁵**
- 6. British Army, Navy, RAF, or Marines Para Wings **2⁹⁵ each.**

ORDER TODAY!

7. Badge of the Rhodesian Army (*See illustration*) printed in black on a tactical tan T-Shirt. *Please state size, Small (34-36) Medium (38-40) Large (42-44) or Extra Large (46-48).* **\$5⁹⁵ each postpaid. Two or more shirts \$5⁵⁰ each.**



8. BADGES OF THE RHODESIAN SECURITY FORCES

- A. RHODESIAN LIGHT INFANTRY
White Metal **\$3⁹⁰**
- B. RHODESIAN GENERAL SERVICE
Heavy Brass **\$3⁹⁵**
- C. BRITISH SOUTH AFRICAN POLICE
Heavy Brass **\$4⁹⁰**
- D. NORTHERN RHODESIA REGIMENT
Black Metal **\$2⁹⁰**

SPECIAL OFFER: Complete collection of all four badges for just **\$10⁹⁵.**

9. Rhodesian Style Camo Cap, *Give size,* **\$4⁹⁵ each, two or more, \$4⁵⁰ each.**

SATISFACTION GUARANTEED All Items Postpaid, Dealer Inquiries Invited. 32 Page Illustrated Catalog **\$1⁰⁰** (Refundable).

LANCER MILITARIA, BOX 35188, HOUSTON, TEXAS 77035 (713) 729-0569

When in Houston, visit our shop 6116 S. W. Freeway (In the common market) Open Weekends



A B C
SOF T-SHIRTS \$5.95 EACH
 100% PRE SHRUNK COTTON PLEASE INCLUDE 70¢ POSTAGE EACH ITEM

ORDER TODAY

FROM: Phoenix Associates
PO Box 693/Dept SF
Boulder CO 80306

T Shirt letter, size and quantity

XL L M S QUANTITY

NAME _____
 ADDRESS _____
 CITY _____ STATE _____ ZIP _____

A				
B				
C				



SOF Exclusive

THE NEW SIDEWINDER: TOMORROW'S SMG TODAY

by Chuck Taylor

Once in a great while, a really worthwhile idea comes along in the field of armaments. Indeed, if one were to seriously ponder the myriad of different military weapons-systems in worldwide use over the last 75 years, it would be seen that only a few ideas of extreme merit, usually in the face of great opposition from those committed to the "conventional" school of thought, have been allowed to develop to their full potential. Among such ideas, for example, were the self-loading rifle and handgun, the airplane, the submarine, and, of course, the submachinegun.

Although a completely new concept in SMGs was created recently in the form of the SIDEWINDER, we are using essentially the same weapons theories today as we did fifty or more years ago. Naturally, various weapons have been modified and improved, but they are still a product of the same basic theories that originally stimulated their creation. The new SIDEWINDER, on the other hand, bears no resemblance in theory, appearance, or utilization, to any other weapon of the present or past.



Sidewinder SMG, light, robust and dependable. Requires minimum training for troops.

In the spring of 1966, arms expert and master machinist Sidney J. McQueen took a long, hard look at all existing automatic weapons designs and decided that a vacuum existed in the area of effective use of the weapon with only one hand. Every auto-arm in existence at that time required the firer to use both hands to handle the weapon at its maximum efficiency. With the technology now available, McQueen felt that there was no reason why it should be necessary to force the firer to use both hands, when it was possible to feasibly create, develop, and produce a weapon that could be as simple, but lighter, more compact, and at least as effective or more effective than any weapon in current use, but to accomplish these things with the use of only one hand! With this objective in mind, he set out to make such a firearm a reality.

After closely examining and evaluating the existing concepts of small-arms design, McQueen decided that the closest weapon in existence to what he was seeking was the somewhat ill-fated EM-2 Assault Rifle of the early 1950s. Although the EM-2 still required the use of both hands, it was, because of the trigger-



Above is .45 cal. version of Sidewinder; a bit heavier, slightly larger than 9mm model. Note yoke that fits into inside of elbow joint. Author uses second finger to increase pointing accuracy.

group being placed amidships rather than to the rear, a superbly balanced rifle and its design was such that it could potentially be adapted to one-hand use.

So, using the EM-2 as a starting point, he began experimenting with more innovative principles of arms design to allow the firer to utilize his weapon, leaving one hand free. The EM-2 was a full-sized rifle, chambered for the .280 (7mm) cartridge that very nearly became NATO standard in the early 1950s. Immediately, McQueen realized that a full-powered rifle cartridge was far too potent to be controlled with one hand and decided to concentrate his efforts on a SMG, since a pistol cartridge offered the best probability of effective one-hand use with adequate power to do the job on the battlefield.

The original tool-room concept model of the SIDEWINDER consisted of a discarded shotgun barrel with an old Thompson SMG vertical foregrip taped to it. From this, McQueen was able to determine that the best point of balance for his new SMG would be approximately six inches to the rear of the muzzle, and the working prototypes were produced in this

configuration. In addition, the magazine well was placed just to the rear of the trigger-group to further enhance the gun's balance.

Obviously, other necessary considerations were weight, overall-length, potential manufacturing speed and economy, and simplicity, but McQueen, with the assistance of his partner, Donald Packingham, continued his work on developing the one-hand SMG, solving each problem as it became evident. Additional ideas were contributed by arms experts Phillip Dater and Robert Baldwin,

of Historical Armaments, Albuquerque, New Mexico, and the SIDEWINDER began to take form.

Eventually, a SMG with a tubular receiver and a nine-inch barrel, weighing between four and 6½ pounds, with an overall length of 18 inches, was created. Extensive testing by McQueen and his associates had disclosed that four pounds was about the minimum a weapon could weigh while retaining robustness and full-auto control, while an overall length of 18 inches, rather than the usual 36 inches-plus, provided superior compactness for carrying and storage.

After more than ten years of development, a SMG that weighs four pounds, with an overall length of 18 inches and a swivel magazine, is a reality. It is astoundingly simple and it works! The final prototype SIDEWINDER is a straight (undelayed) blowback weapon with a cyclic rate of 1200 rpm, and, depending on caliber, a 30-32-round box magazine.

Its concept of operation is to merely grip the trigger group, fit the yoke at the rear of the receiver into the inside of the elbow joint, point the index finger at the target, pull the trigger with the second finger (a la derringer), and watch for results! For left-handed firers, the entire magazine-well assembly can be swivelled as much as 360 degrees in either direction to whatever position is desired or required. This feature lends itself particularly well to situations where wounds, obstacles, or vehicles would severely restrict efficient use of a conventional system.

When asked about his reasons for creation of the SIDEWINDER, McQueen responded: "We're faced with a changing concept in the make-up of military power as we've known it in the past. We are going to see the very young, the very old, and the female become commonplace on the battlefields of the future. When we talk about wars of the scope and magnitude that we will face, we're talking of global and total warfare. At such a point, the entire spectrum of civilization and all its inhabitants *must* be utilized if we are to have any hope of survival. The SIDE-

Sid McQueen discusses merits of Sidewinder with SOFers during test and evaluation.





Sidewinder is only SMG to fire pistol cartridge. Magazine to rear of pistol grip enhances balance.

homework. I found their statements of fact most sobering. . . .

The prototype SIDEWINDERS were produced in 9mm parabellum and .45 ACP for reasons of worldwide continuity, with the .45 being necessarily slightly larger and a bit heavier than the 9mm version. However, it still remains well within the 6½-pound-18-inch overall requirement mentioned earlier. The 9mm gun utilized a 32-round MP-40 magazine, while the .45 sported a 30-round M3 "Greasegun" mag. In both calibers the production guns will feature a double-column box magazine which is similar in design to the Thompson magazine that feeds alternately from both sides of a double column of cartridges rather than from a single row forced from a double row, a common concept these days. Personally, I feel that this is an excellent idea and will definitely enhance feeding reliability and magazine life.

Additional features of the production guns will be a progressive trigger, allowing the firer to achieve semi- or fully automatic fire by trigger control rather than a selector-switch (which McQueen

SOF Publisher R. K. Brown test fires a modified M-2 carbine that served as a prototype for the Sidewinder.

WINDER can be readily used by a conventional military organization or by guerrillas or common citizens for any urban, jungle, or vehicular combat situations that may arise because of its superior pointing ability, compactness, lighter weight, and simplicity."

Unquestionably, the SIDEWINDER does have excellent pointing ability. The weapon actually feels as if it has become an extension of the firing arm, with any movement of the muzzle accomplished by moving the torso or the position of the legs, rather than by swinging the arms, as with other weapons. The firer is the gun platform and all movement originates from him. The SIDEWINDER is designed to adapt the firearm to the individual instead of the common practice of adapting the individual to the firearm. In the past, considerations of time and expense have prohibited utilization of such a principle, and, in my opinion, justifiably so, but now an almost ideal system is within grasp.

Robert Baldwin, an expert in guerrilla warfare, added: "Anyone who studies military history knows that much of the warfare of the future will be highly unconventional, and will be of an urban nature, because it will occur in countries that are highly urbanized. As civilization falls apart, anarchy and disorder will become more and more prevalent. The SIDEWINDER lends itself perfectly for this type of fighting."

As I considered Baldwin's statement, McQueen continued: "Those who are most vulnerable in warfare, it seems, are the civilians caught in the middle.

SOFers pose after test firing. Suggested title for photo was, "What if They Gave a War and We Came."

Civilian casualties seem to occur in almost a reverse ratio to the number of able-bodied men that can be placed into the military field. This leaves the old, the young, and the women as the easiest targets for an oncoming force. The SIDEWINDER can easily be utilized in a similar manner to the German Volkssturm carbine of World War II, i.e., last ditch defense. It is an all-people gun because all sizes, all ages, and all sexes can use it in combat with little or no formal training and become proficient with it because of its simplicity, small size and light weight, and especially because of its pointability."

To me, at least, there was no question that all of those involved in the SIDEWINDER project had indeed done their





feels "is always placed in an inaccessible place for use under stress"), a reversible bolt to allow the use of either the 9mm or .45 by merely reversing the bolt and replacing the barrel and magazine, a telescoping buttstock which fits around the tubular receiver to allow the weapon to be used at ranges where the one-hand feature is not practical, and foldup sights, including a provision for use of the Singlepoint, Starlight, or Conventional telescoping sight-systems.

Firing the SIDEWINDER, especially when one is already trained in conventional SMG techniques, requires a bit of familiarization but definitely would require a much shorter training period than any existing weapons-system. With a short instructional session from McQueen, I was able to place effective fire on the target with little difficulty.



Some malfunctions were encountered while testing the prototype guns, but one should remember that both of the weapons are testing prototypes, created specifically for the purpose of solving various design and production problems. In actuality, none of the problems experienced are worth mentioning since they were easily correctable.

What do I think of the SIDEWINDER? Admittedly, I was impressed! In fact, I placed my order for one of the first production guns on the spot!



In summary, the SIDEWINDER system reflects an immense amount of foresight, design-simplicity, and economy, all of which are very important considerations to any military organization, particularly during wartime. It's a winner and could be the answer to many a soldier's prayer. Let's hope that those who are of the infamous "conventional school of thought," do not fail to recognize this fact!

Interested personnel should contact Sidney J. McQueen, 414 Coors Boulevard, Albuquerque, New Mexico, 87105, U.S.A.



Photos one through three illustrate movement of unique rotary magazine to left: provides firer with flexibility.

Photos four through six demonstrate movement of rotary magazine to right. This concept facilitates directing fire around buildings, obstacles.

Now: Two fantastic books about the Oriental weapon — Nunchaku



"THE NUNCHAKU & POLICE TRAINING"
\$3.95, 69 pages, P/B with photos and many diagrams. An indispensable handbook for Nunchaku training.
By JAMES PHILLIPS



"NUNCHAKU II"
\$6.95, 276 pages. Deluxe hardbound. The most authoritative work in existence on this intriguing weapon. Chapters include: specimen evaluation, Chinese underworld, basic and advanced techniques, plus more. A must for any martial arts library.

NUNCHAKU CATALOGUE \$1.00
POSTAGE ON ORDERS \$1.00

Order from: JIM PHILLIPS
P. O. BOX 168
WILLIAMSTOWN, N. J. 08094 U.S.A.

THE PROFESSIONAL HAS ARRIVED

THE RUGGED BINOCULAR THAT IS BUILT TO LAST A LIFETIME

The L.E.S. Professional binocular was manufactured under the continuing demand for a high quality, waterproof binocular made specifically for outdoor use anywhere.

Its rubber (neoprene) coated exterior is a vast improvement over the normal shiny pebble grain finish. It absorbs shock and is highly water resistant.

For the pro who needs a pair of binoculars for heavy use in the field, the Professional is the perfect choice. Its army green exterior serves as camouflage in the field and because it is dull rubber coated it does not reflect light or glare as the normal pair of binoculars.

The optics used are of the finest made, utilizing the fine Zeiss type prismatic optical system. It includes fold down rubber (neoprene) eyecups to accommodate easy spotting at short or long distances.

To facilitate handling for the man on the move, it is encased in a lightweight, canvas carrying pouch with quick-open fasteners.

The L.E.S. Professional binocular is a multi-purpose optical system for the man that must have it all. Light, compact and waterproof—it employs all the features a pair of binoculars should have.



**TO ORDER SEND CHECK OR MONEY ORDER FOR \$89.95*
PLEASE ALLOW FOUR WEEKS FOR CHECK TO CLEAR
SEAGULL INTERNATIONAL
BOX 806
MUDELEIN, ILLINOIS 60060**



*INCLUDES SHIPPING & INSURANCE—QUANTITY PRICES AVAILABLE ON REQUEST

T-Shirts \$5.95 ea. plus \$1.00 postage. Add 75¢ postage per additional shirt. Indicate design number; sizes s, m, l, xl, and quantity of each design.

ALLOW SIX WEEKS DELIVERY
Dealers inquiries welcome.
CUSTOM UNIT DESIGN

All T-shirts 100% pre-shrunk cotton. Hand screened inks. We use no heat transfers.

For tactical usage, our white shirts may be dyed light green, without affecting the design.

UNIT-T-SHIRTS AND DESIGNS

1. "LA LEGION" — FRANCE
2. "COMMANDO" — ENGLAND
3. "SPECIAL - AIR - SERVICE - ENGLAND"
4. "U.S. SPECIAL FORCES" —
5. "PARA-REGT" — ENGLAND
6. "CANADIAN PARA-REGT — (Current or W.W.II)
7. "U.S. PARA-WING — (NOVICE, SENIOR, MASTER)
8. "SOLDIERS OF FORTUNE"
9. "HELICOPTERS" — ("HUEY", "COBRA",
10. "ARMOUR" — ("M-60", "LEOPARD")
11. "ENTEBBE RAID"
12. "U.S.M.C." ("FIRST TO FIGHT" OR "RECON")
13. "APOCALYPSE" (S.E.A.)
14. "AIRBORNE-RANGER" — U.S.A.:
15. "L.R.R.P." — U.S.A.
16. "PATHFINDER" —
17. "S.E.A.L." — U.S. NAVY
18. "H.A.L.O."
19. "WAFFEN S.S. DEATHS HEAD"
20. "FALLSCHIRMJAGER"
21. "A BRIDGE TOO FAR" (ARNHEM)
22. "SURVIVOR-PARTICIPANT - S.E.A. WAR GAMES"
23. "COMBAT SHOOTIST" (HANDGUN-COMBAT)
24. "MORS-EX-COELUM" (DEATH FROM THE HEAVENS)
25. 82ND ABN-DIV
26. 101ST. ABN-DIV
27. 18TH ABN-CORP
28. U.S. NAVY
29. U.S. AIRFORCE
30. "FLYING TIGERS"

A.V.G. PATCH (COPY OF ORIGINAL ON T-SHIRT OR CLOTH "SEW-ON" FOR BACK OF FLIGHT JACKET.

"HARDCORE"
ACTION
T-SHIRTS

Phantom Graphics

726 RICHARDS ST.
VANCOUVER, B.C., CANADA
V6B 3L2 PHO. 604-681-9385



ANY OF ABOVE DESIGNS WITH SURVIVOR-PARTICIPANT "S.E.A." WAR GAMES DESIGN ON REVERSE \$10.95.

The kick is violent, and the noise when fired from the shoulder irritating. From the hip, the blast is deafening, but, control is excellent. It doesn't twist or climb; it just locks on target driving out 7.62mm bullets at 700 rounds per minute. Placing this rifle in the hands of inexperienced troops, however, would be an eye-closing, flinch-producing disaster.

the shooter off balance, but when shooting 7.62 NATO, three shots should be enough. On semi-auto with a hot barrel and poor rest, the rifle grouped five shots inside four inches. Proper bench rest techniques could likely narrow this to two or three-inch groups.

After 50 fast rounds, smoke began to pour off of oil on the barrel and then it be-

tain consistent hits on a silhouette at 100 yards without using the sights, after a few dozen practice rounds.

The front sight is a fixed blade. The aperture rear sight is raised or lowered on its threaded pedestal by turning the drum in the carrying handle. There is no windage adjustment, but loosening a

GREAT EXPECTATIONS: AR-10

The gun I am talking about is the AR-10 assault rifle, perhaps the most ill-timed, ignored and forgotten gun of its quality ever produced. It can be compared to the last of the British Spitfires — dazzling pieces of technology and design, but doomed to obsolescence by a world moving in another direction.

Designed by Eugene Stoner before and during his tenure with Armalite, the rifle was produced in quantity only in Holland and it appears that less than 4000 were ever built.

The gun pictured in this test was made midway through production at the Dutch government-owned Artillerie-Inrichtingen plant and sold to the Sudan by Interarms, of Alexandria, Virginia.

The AR-10 looks like a large AR-15, but, in fact, the reverse is true: the AR-15 is an *evolution* of the AR-10. The two guns are almost identical in

screw allows zeroing by moving the rear sight.

Firing 150 rounds left only a light blackening on the inside of the bolt carrier and on the bolt itself. Carbon buildup in critical areas was practically nonexistent. After trying the gun dry, we added a glob of LSA lube. (The blackening visible in the photos is the lube mixed with liquid carbon.) While the M-16 was later to have carbon problems, they were due to a change in ammunition propellant, lack of cleaning and the smaller dimensions of the M-16. According to the designer, the AR-10 was so free of carbon problems, that no special cleaning tools had to be provided.



BY TERRY EDWARDS

design and construction, sharing alloy receivers, fiberglass or plastic stocks and pistol grips, in-line design and high-over-the-bore lines of sight.

It takes time to get used to the AR-10. Recoil exceeds that of the FN/FAL or the M-14, but is not unmanageable for anyone of average North American build. The rifle's remarkable feature is its combination of light weight (nine pounds empty), pointability and uncanny control under rapid or full-auto fire. The in-line stock configuration is designed to eliminate muzzle climb by placing the axis of the bore in line with the shooter's shoulder so the gun will kick straight back instead of pivoting around the shoulder. It works. Laying a three shot burst on a silhouette target at 100-yards is no problem. After that, the kick begins to knock

came too hot to touch. Accuracy did not seem to be affected. The Portuguese, who bought 1200 AR-10s for use in their colonial wars, also found the gun had no over-heating problems, even when the African climate gave such tendencies a head start.

For the soldier whose main concern about a 7.62mm rifle is dragging it for miles through the bush, the AR-10 comes through as a light, handy and easily-manipulated weapon. The weight balances at the front of the carrying handle, and if the shooter hooks his index finger around the cocking handle, the rifle can be loaded and shouldered in one quick motion. The gun points naturally, like a shotgun. An experienced trooper can ob-

Only two minor problems occurred in testing. The first was the cocking handle's habit of coming free and sliding around inside the carrying handle. A replacement of spring corrected this problem. The second was more a lesson in safe gun handling than a problem. After a long burst, the gun stopped—apparently empty. The fact that the bolt stayed closed instead of being hung up by the hold-open device, should have been the tip-off, but no one noticed. Our shooter cleared the bolt to the rear, released it (still not realizing this should not be happening), pointed the gun down-range and triggered it. Instead of the expected clack of the hammer, off went another round. A cartridge had become hung up in the mag, chambered during clearing and gone off. Fortunately,

proper safety procedures were used, and paid off.

Overall, it is hard to fault the AR-10. Three hundred rounds is not an endurance test, but, all of the gun's stoppages had to be blamed on the magazine. The AR-10 is a handy, confidence-inspiring rifle—one of the best to come out of the era that spawned it. As its history shows, the AR-10 got little chance to prove itself. The design lives on in the AR-15/M-16 rifles of today. If it needs any vindication, it achieves it in Colt's production of over three million M-16s and their adoption by many nations.

The AR-10 story began in California in 1947, when two brothers-in-law, Charles Dorchester and George Sullivan, got together to design and build a new bolt action rifle. Their idea was to incorporate a foam-filled plastic or fiberglass stock and lightweight alloys into a hard-hitting, Mauser action rifle. Both these men were

rifle. Like Sullivan and Dorchester, Stoner was using light alloys and composition stocks in his design. Sullivan offered Stoner the post of Chief Engineer. Stoner accepted, sold his part of his consulting engineering firm to his partners and joined Armalite as the third employee. Three more firearms experts joined Armalite: Arthur Miller, who was later to design the AR-16 and AR-18 rifles, arms designer L. James Sullivan, and Robert Fremont, the engineer who tackled the design tolerance problems of mass-producing Armalite weapons.

In 1954, the small arms world was in a state of flux. The industrialized nations were engaged in choosing replacements for outmoded rifles, and arms manufacturers around the world were falling over each other for orders. The big plum, of course, was the United States. Tests in the U.S. started in 1950, putting the FN/FAL, the British EM-2 and the

to develop a survival rifle. Armalite responded with the AR-5. The rifle was adopted by the Air Force as the MA-1. Encouraged by this success, Armalite took a closer look at the military market and accelerated work on the rifle Stoner had brought with him to the firm.

Stoner's rifle, designated the AR-3, was a .30-06, gas-operated, in-line design with lightweight components throughout. The gas operation was a conventional piston design, but the bolt featured a multi-lugged, lock-up system. The bolt design was slotted for use in the new assault rifle.

Stoner designed the new gun with an in-line stock, an aluminum alloy two-piece receiver hinged at the front for field-stripping, an aluminum barrel with titanium liner, and fiberglass stocks and pistol grip. The trigger mechanism was similar to the M-1 carbine, and an integral carrying handle housed the



Author firing AR-10 from hip during tests. AR-10 was predecessor of widely adopted U.S. AR-15/M-16.

successfully following full-time careers, so the project moved slowly from basement to garage. In 1952, the men decided to form their own company: Armalite.

Armalite got into gear in 1954. That year, Sullivan met with the late Richard Boutelle, then-President of Fairchild Engine and Airplane Corporation. Boutelle was impressed with the lightweight concept and its potential. On October 1, 1954, Armalite became the Armalite Division of Fairchild Engine and Airplane.

At this point, there were six more words in the company name than employees on the roster. Sullivan got in touch with an ex-Marine working in California as a consulting engineer, named Eugene Stoner. Stoner, who had a lifelong fascination with firearms design, was working in his spare time on his own

Springfield Armory T-25 in competition. Yet, the tests were unsatisfactory. The T-25 was found unsuitable and replaced by the T-47. The British and Belgian guns were sent home on the basis of their .280 caliber. Britain gave up, but Belgium came back with an FAL in 7.62X51mm NATO. Meanwhile, the T-47 had been shelved by Springfield in favor of the T-44. Then, the FAL developed problems. They were corrected and the tests moved on to troop trials, manufacturing trials, etc. Europe was in a similar state, and the time seemed ripe for a new assault rifle.

When he arrived at Armalite, Stoner had to divide his talents. The AR-1, as the rifle Dorchester and Sullivan began came to be called, had to be finished. Then, the U.S. Air Force asked Armalite

rear sight well over the line of the bore, The front sight was mounted on a pedestal above the gas port in the barrel.

The gas system chosen was a departure from the conventional piston type. In the AR-10, the gas exits from a gas port on top of the barrel about six inches from the muzzle. It then travels via a chromed steel tube, back along the barrel to the action. This feature was not new. The AG-42 used a similar system as designed for the Swedish Army by Ljungman during World War II. In the Ljungman system, the gas strikes inside a cap at the top front of the bolt carrier above the axis of the bore which results in a tipping, out-of-line torque on the part of the bolt carrier. In the AG-42 action, which rests on a machined steel base, this is not a problem, but, such a torque would tear hell out of a light alloy receiver. So,

Stoner designed his own version of the pistonless gas operation.

When the gas in the Stoner design reaches the receiver, instead of hitting the bolt carrier directly, it is channeled inside the bolt carrier. There it enters and fills a chamber created by the locked bolt and the bolt carrier. As the gas expands, it strives to expand the chamber and can do so only by pushing back the bolt carrier, which cams the bolt unlocking it seven lugs from the barrel extension. The important thing is that this chamber actually surrounds the part of the bolt, sealed by piston rings on the bolt. Thus, the unlocking thrust is in a straight line to the rear, in-line with the axis of the bore. This eliminates any stress on the receiver and also allows the receiver to be constructed from light, relatively weak materials.

The AR-10 field-stripped. In actuality, system is simpler integral with the bolt carrier, rather than incorporating a than current M-16/AR-15 in that cocking actuator is separate charging handle as with the M-16.



In 1955, the AR-10 was introduced to a startled and impressed small arms world. Among others, representatives of Artillerie-Inrichtingen showed up at Costa Mesa to see the new gun. They were so impressed, they asked to manufacture it. Armalite agreed to their proposals in 1956 and issued a production license, whereupon Stoner and Miller went to Holland to assist in converting the design to metric dimensions and starting up production.

Armalite then began an ambitious marketing and public relations program. Besides Artillerie-Inrichtingen, Interarms of Alexandria, Virginia, Cooper-MacDonald of Baltimore, Maryland, and Sidem International of Bonn, Germany, were chosen to sell the new rifle. Ads appeared in publications around the world, while Armalite scrambled to deal with inquiries.

A test of the new gun was arranged at Springfield Armory. At the time, U.S. government was still conducting tests of new weapons, but it appears the T-44 (destined to become the M-14) had already won.

Several guns were packed up and Stoner traveled with them to the Connecticut armory. The test got off to a bad start when Stoner was met at the door by irate Springfield employees brandishing copies of the current issue of Time magazine, which had hit the streets while Stoner was still in the air over the mid-west. In the article, an Armalite public-relations man was quoted as saying some less-than-flattering things about the U.S. government small arms development program. Since that program centered on Springfield Armory, the Springfield people were a little upset.

The test got under way again, once feathers were smoothed.

The AR-10s gave little trouble, digesting thousands of rounds with performance rivaling the other rifles then being considered. Just before the fire testing was to end, one of the titanium-lined barrels blew up. The guns and Stoner returned to Costa Mesa, where the guns were put into all-steel barrels. The aluminum barrels were not tried again. The rebarreled guns went back to Springfield and completed the tests without incident, but Springfield had already filed its report after the barrel-bursting episode, and American government interest died.

Things were not going much better in Holland. The Austrian government took a long look at the AR-10 and decided to adopt it for their army. Artillerie-Inrichtingen told them delivery would take

two years. The Austrians couldn't accept this and turned to FN. FN assured the Austrians that the FAL was ready to go and shipped off several hundred for testing. The Austrians found that parts of the guns were not interchangeable, the FALs to FN, and called on Artillerie-Inrichtingen again, with a firm order. But Artillerie-Inrichtingen was having money problems. The Dutch Army had decided it didn't like the new gun, and since Artillerie-Inrichtingen wasn't a state-owned company, they were not able to pry enough money out of their government. Austria eventually went back to FN and equipped with the FAL.

Artillerie-Inrichtingen finally started producing the AR-10 two years after they got their license. By that time, orders such as Austria's had come and gone and

the expensive ad campaign was largely wasted.

As produced in Holland, the weapon was essentially the same as the Armalite prototypes. The Dutch version eliminated the combination muzzle brake/flash hider/suppressor of the early guns, because most customers had demanded bayonet-mounting, grenade-launching, blank-firing attachment-adaptable barrels. To give this capability, the Dutch made steel sleeves that slide over the barrel from the front sight base to the muzzle and have either a bayonet lug or grenade launcher built on. Most flash hiders are three-pronged; some are threaded on the end for a blank-firing attachment, while early production guns are not. The barrels are steel, while the stocks are made of either plastic or fiberglass. The receivers are machined aluminum alloy forgings. The bolt and

the bolt carrier are made from brushed chrome-plated steel. The recoil spring is housed in a steel tube through the butt.

The action is buffered by an aluminum and steel buffer assembly. Loaded, the rifle weighs just over 10.5 lbs. It is 40.25 inches long, with a 19.75-inch barrel, rifled with four wide grooves taking a turn every 10 inches. Some early production guns may be found with chromed chambers.

During production, different tools and materials were utilized; therefore, differences are evident between individual rifles. Stocks were made from both fiberglass and plastic and can be found in green, brown, or black. The gas tubes were made from chromed steel, but there are rumors of a few made of stainless steel. Artillerie-Inrichtingen added their

adjustable. A small valve screw, visible on the front of the front sight base, was used to pre-set the gas at the factory before the gun was shipped. The user should never have cause to tinker with this valve, nor is there a safety sear in the gun. The design of the bolt and carrier precludes the firing pin clearing the bolt face unless the action is locked.

Both Armalite and Artillerie-Inrichtingen produced experimental models of the AR-10, including magazine and belt-fed light machine guns with quick change barrels and a short-barreled carbine version. Several fore-end designs were tried in plastic, fiberglass, and wood and stamped steel, none of which passed through the prototype stage.

At least two sniper versions were produced, differing mainly in the method of mounting the four-power scope on the

depressed. The handguard cannot be removed unless the front sight base is removed.

One of the first announced sales of the AR-10 was to the Sudan. Sam Cummings of Interarmco (now Interarms, Alexandria, Virginia) sold 300-400 of the weapons while in the Sudan. The sight graduations on the Sudanese guns are in Arabic. Other sales were made to Nicaragua and Burma. At least a few of the Artillerie-Inrichtingen guns were imported to the U.S. These can be identified by the electro-penciled word "Holland" above the stamped word "Nederland" on the magazine housing. Portugal got the last guns to come off the production line in 1959. They bought 1200 rifles, many of which saw extensive use later in Angola and Mozambique.

Close up view of right side of AR-10. Other than size differences, rifle is almost identical to its successor, the AR-15. Note cocking actuator inside rear-sight base/carrying handle.

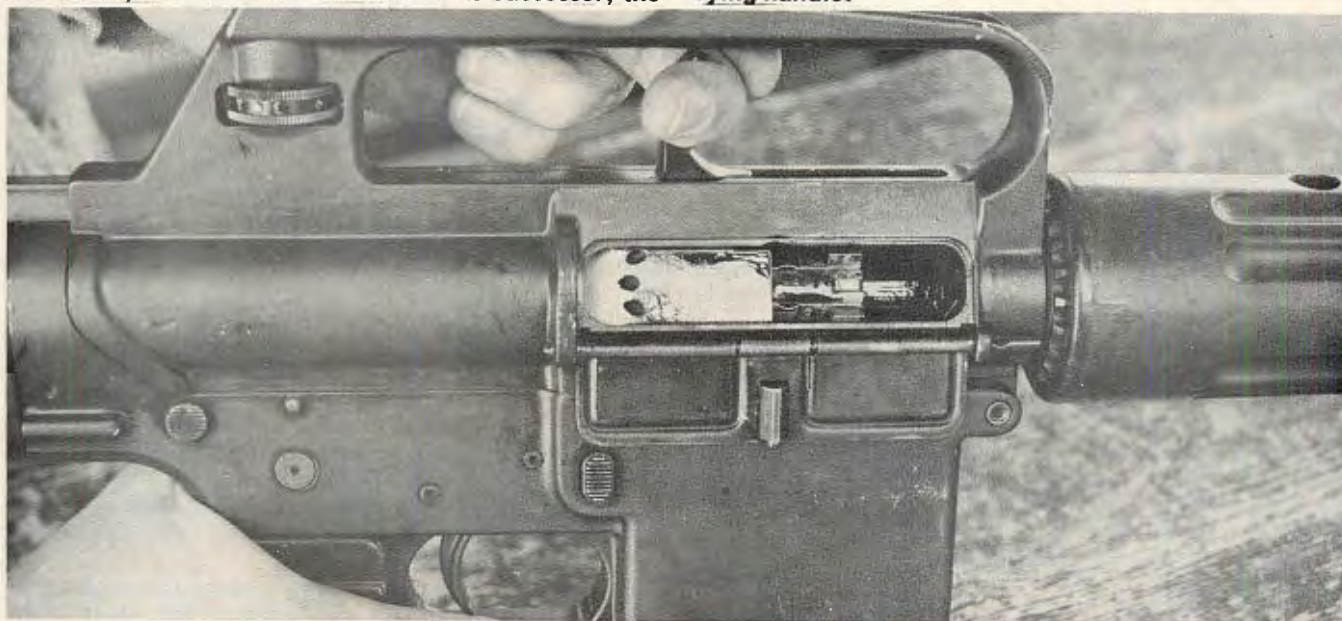

own touch . . . cooling fins machined into the barrel within the handguard. The jacket has longitudinal fins to dissipate heat. The handguard is lined with hard polycarbonate foam and is reflective. Some guns were provided with night sights, which are simply white dots added above the rear aperture sight and below the front blade sight. Sometimes the paint used was luminescent, sometimes not.

Artillerie-Inrichtingen also experimented with semi-auto models. Early guns released gas from the bolt carrier straight out to the side through the ejection port. This arrangement was changed and three holes were used, angled forward to direct the gas away from a left-handed shooter's face.

There is no primary extraction in the AR-10 to loosen the case before extraction. In an action as inherently violent as unregulated, straight-through gas, one would expect primary extraction, but, Stoner claims that it simply wasn't needed. Actually, the gas system is

carrying handle. Many of these scopes were later marketed in the U.S. by Colt. A bipod attached to a specially-designed version of the front sight base folded back to become part of the handguard when not in use. Wire-cutting bayonets, grenade launchers, slings, cleaning kits, and blank-firing attachments were produced. All production AR-10s use the 20-shot waffle-pattern aluminum magazine pioneered at Armalite, have the cocking handle inside the carrying handle and adapt for gloved use by folding down the bottom of the trigger guard.

Field stripping the AR-10 involves no tools. With the gun cleared, the soldier merely pops out the pin holding the rear of the receiver halves together, and breaks the rifle. A tug on the cocking handle will bring the bolt carrier out where it can be grabbed and removed. This carrier, bolt, firing pin assembly comes apart by removing one pin and the bolt camming stud. The buffer assembly and recoil spring are removed after the detent holding them in the buttstock is

Development work at Armalite produced two more experimental models: the AR-12 and the AR-14. The AR-12 was a stamped-steel version of the gun designed for rapid production. It probably would have cost \$45 to make at the time. The AR-14 was a Monte Carlo stocked semi-auto for civilian sales. Armalite was never equipped for mass-producing the AR-10 and only turned out batches of prototypes—about 100 guns altogether.

Late in 1957, Joe Lyman visited Armalite on behalf of the U.S. Army. The Army was seeking a small caliber, light-weight rifle and wanted Armalite to have a shot at the project (no pun intended). Armalite produced the AR-11, a selective fire rifle with a standard configuration stock. The stock design and the gun's excessive rate of fire made full-auto fire uncontrollable, and the design was abandoned. The AR-10 drawings were dusted off and Stoner and his team scaled the gun down to .222 caliber. Six months after work began, 10 prototype rifles were

delivered to the Army for test at Aberdeen Proving Grounds. The gun, later changed to .223, became the AR-15. Although no one realized it at the time, it was also the AR-10's death knell.

Shortly after Portugal received 1200 rifles, the licensing agreement between Artillerie-Inrichtingen and Armalite came up for renewal. A dispute over territory had cooled relations between the firms and the agreement was allowed to lapse. The fate of Artillerie-Inrichtingen's production tooling is not known. So, the AR-10 ceased to be made in 1959. In January of that year, Colt's Patent Firearms had acquired manufacturing rights for the AR-15, and when the AR-10 became a free agent, Colt got the rights to it as well.

Armalite decided to overhaul the design of the AR-10 before Colt began production. The cocking handle was moved to the rear of the receiver, the bolt and extractor enlarged and the flash-hider/muzzle-brake/suppressor of the early prototypes was re-introduced in modified form. The re-designed gun was designated the AR-10A. While Colt was part way through tooling up, it became obvious that the AR-15 would eclipse the AR-10. Armalite and Colt agreed to drop work on the AR-10A. Only one or two AR-10As were produced at Armalite.

Fairchild and Armalite parted company in 1961. That same year, Stoner left the firm to do consulting work for Colt and Cadillac-Gage. With Cadillac-Gage, he developed the Stoner 63 System. He also worked with Thompson, Ramo and Woolridge of Port Clinton, Ohio, where he developed the TRW 6425 single-barreled automatic 25 produced by Oerlikon as the KBA-B and KBB. He now runs Aries, Inc., founded in the early '70s. Stoner himself is pursuing re-



Portuguese merc with AR-10 during recent Angola fiasco. Note recesses in handguard for bipod, indicating late model Dutch production. Several hundred AR-10s found their way into Angola via the Sudan.

Another Evaluation Of The AR-10

By

John Michaels

John Michaels, a Canadian weapons expert, tested one of 200 AR-10s recently imported to Canada from the Sudan. Following are excerpts from his test reports. (Ed.)

Test-firing 500 rounds of ball ammunition produced no malfunctions, and with the exception of extracted brass being spat in different areas because of a wide range of different ball test ammo, the weapon behaved magnificently. The AR-10 produces, with the splayed prong flash hider, only slightly more recoil than the M-16.

The Sudanese variant lived up to the legend of the AR-10. It cycled mixed loads flawlessly. Cleaning of the weapon was combat S.O.P., lubricating with Dri-slide and a quick assembly.

With the exception of the author, the two shooters who helped with the test had never before seen an AR-10, much less fired one. Both were impressed. It has been a long time since I have seen an incredulous look of joy on a man's face. It was a pleasure to behold.

The feature of the AR-10 I wished had been incorporated into the SP-1, AR-15, or M-16, is that of the charging handle. Instead of extending the arm (dependent upon whether one is left or right-handed, various postures must be adopted to draw back the rear charging ears as on an M-16), one simply curves the finger around an inverted trigger-shaped hook under the sight platform/carry handle, briskly draws it to the rear, and releases. This is much faster, and when field stripping, one does not have that extra three to five second jiggle that is usually incurred when reinserting the bolt and charging track. With novices, this may turn into a longer ordeal where a situation could occur that would be fatal.

One could go on indefinitely listing the merits of the AR-10. I am sorry that I cannot list any faults other than the early

search in "larger calibers," but there are "one or two small arms programs going on."

Art Miller worked with Stoner in developing the AR-16 rifle before Stoner left. Later, Miller was to scale down the AR-16 and produce the well-known AR-18.

Sullivan left Armalite to join Lockheed and Dorchester stayed as Chairman of the Board, a post he holds today.

Artillerie-Inrichtingen? Well, they're out of the gun business now. When Armalite President, Richard Klotzely, visited Holland a few years ago, he decided to ring them up for old times' sake.

"They didn't even want to talk about guns."

phenolic composition handguards which are, however, repairable with fiberglass. Of all modern assault rifles, only the AR-10 feels solid, yet light. Even if one has to fix the bayonet for close quarter fighting, the AR-10's strength and weight inspires confidence.

Until the 4.85mm round becomes more prevalent, I will stay with the 7.62. The 5.56 has its beautiful moments, especially in low ammo weight, but anyone who has been up against fixed fortifications, especially bunkers, will know of what I speak. I opt for the 7.62; the 5.56 just doesn't cut the cake in that situation. If one doesn't have an L.M.G. along in such situations, it can spell disaster.

The specifications of the Sudanese AR-10 variant are as follows:

CALIBER:	7.62mm (NATO)
OVERALL LENGTH:	1,035mm
WEIGHT/EMPTY MAG.:	3.36 KG.
MAG/CAPACITY:	20 rds.
BARREL LENGTH:	543mm
TWIST:	Right hand
LENGTH OF RIFLING:	450mm
NUMBER OF LANDS:	4
SIGHT RADIUS:	525mm
SIGHT ADJUSTMENT:	Up to 600 meters (calibrated in Arabic).

I know our American brothers will be gnashing and weeping at this point because of the 1968 Firearms Act, forbidding importation of military arms into the U.S. We have always felt this strange, since there are more military surplus weapons in the U.S. than anywhere else.

One can only wonder why Inter Arm Co. has not produced the AR-10 commercially. We can only hope that they will. A man deserves the best he can obtain in our troubled world. For my professional money, it's the AR-10.

The writer would like to thank Richard Klotzely of Armalite and Eugene Stoner of Aries, Inc. for their invaluable assistance in preparing this article. Other research material was derived from W.H.B. Smith's Small Arms of the World, and Major F.W.A. Hobart's work in Jane's Infantry Weapons 1975 and Small Arms Profile #22. The test gun was supplied from the Unit Nine collection.

It was brought to our attention that AR-10s were advertised for \$775 by Gun and Tackle, Tetachwan, Ontario. Subsequent investigations revealed that these AR-10s can only be imported by a Class III dealer, who in turn, can only sell them to law enforcement personnel or the military. Any other individuals should be subject to prosecution under the 1968 Gun Control Act.



BLACKJACKS AND BILLIES

BY DAVID STEELE

The patrolman casually walked his beat near 5th and Main in downtown Los Angeles. The evening was cool, but not cold enough to keep five young punks from appearing, taunting the officer for no reason but sport. The patrolman knew the odds were bad, so he just walked by, letting the lads continue their game. He walked to a callbox, put in a request for assistance. As the backup was arriving, he walked up to the gang leader, told him he was under arrest for disturbing the peace. The gang leader swung but not fast enough. The officer landed an open-hand blow to his temple which put him on the sidewalk. His companions scattered into the arms of the other officers, muttering about how their leader had been decked by a slap. What they didn't know was that while the officer was putting in his call for assistance, he was also slipping on a palm sap under his glove; his "slap" was backed by six ounces of powdered lead.

This incident occurred some years ago. Although the palm sap, a lead-filled pod on a watchband-type strap, is still made (Lewis Leather Goods in Los Angeles is one maker), it has been largely superseded by sap gloves, such as those made by Damascus Leather Shop in Boring, Oregon. Sap gloves have six ounces of granulated lead in either the palm or across the knuckles. The knuckle sap variety is more practical since it allows conventional fist blows, protects the back of the hand when using the baton, and allows grasping the service revolver. Sap gloves can also be swung like a blackjack if there is no time to put them on.

The next step up from the sap glove is the light blackjack. Although it is possible to "choke up" on the 'jack, using its head for short thrusting blows, this weapon is designed for swinging blows, which can be used to sting and incapacitate large muscles, disable joints, and snap the skull forward, creating concussion and unconsciousness. These blows may also cause lacerations (cuts), contusions (bruises), and skull fracture, but, if used properly, blackjacks are safer to use than conventional clubs — safer, though less versatile and usually less effective.

Some blackjacks are made from rubber. Rubber saps are quite safe compared to the lead variety, with practically no danger of fracture, concussion, or severe laceration. They can be used quite

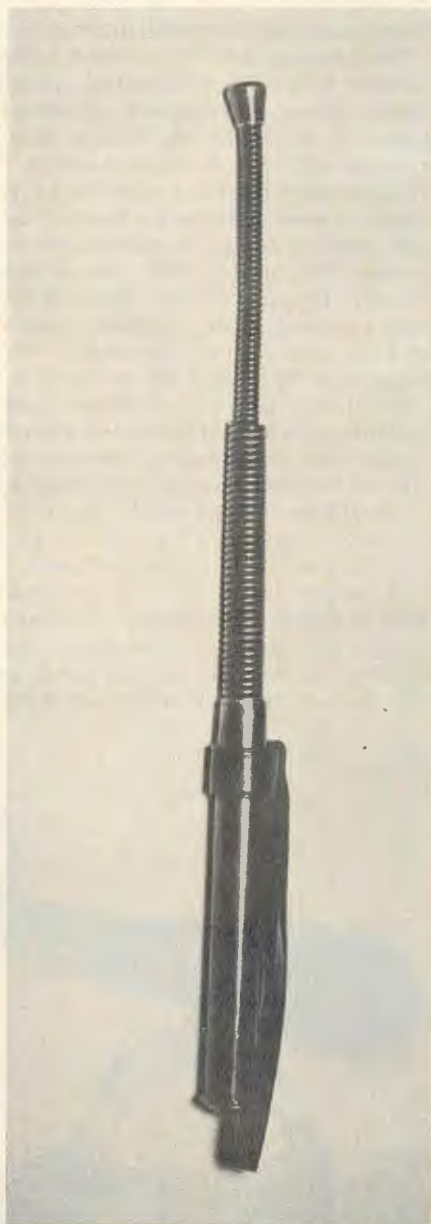

The "Gestapo" spring cosh. The root tube is solid, the interior tubes are heavy coil springs swung into position by gravity action. The head may be steel and comparatively light.

well in prisons. Prisoners are most likely to attack impulsively without weapons, so using severely incapacitating weapons on them makes for bad press. Also, if prisoners should snatch away the officer's rubber sap they could not easily use it to kill or maim him as might be the case with other weapons. Though rubber

saps have been used in the past as "interrogation tools" (the "Gestapo rubber hose" image), their proper function is to convince a prisoner to do whatever he refuses to do (strip for search, go through a doorway, stop fighting with his cellmate, etc.) by judicious blows to nerve centers or large muscles. Although there are unarmed techniques for performing these functions, most institutions do not provide sufficient training to give a guard an equal chance against an inmate who may have been training for years in the prison weight room.

The rubber sap should be as standard as Chemical MACE in detention facilities. Some jails and prisons also authorize the use of lead-loaded blackjacks, Kel-Lites (police flashlights), and Stun Guns (a billy which also launches a shot-filled bean bag); these can be very useful, but their use must be accompanied by procedural protections to effectively prevent their being snatched from the officer and used against him.

The next step up from the rubber sap is the lead-loaded blackjack. This is a leather-covered device six to eighteen inches long, averaging eight to 10 inches for the standard police models. It may weigh from six to 34 ounces and usually weighs from six to 12 ounces. There are four main styles: 1) the flat sap, with a solid lead pod fused to a flat spring (such as the Bucheimer "Denver" or "Texan"), 2) the round sap, with a rounded lead pod connected to a coil spring (such as the Bucheimer Models 821, 7980, 8980, etc.), 3) the lead shot-filled sap (such as the Bucheimer Model 211), and 4) the "lead clay" or granulated lead-filled sap (such as the Bianchi Model 39).

There are advantages and disadvantages to each style. The type least likely to lacerate or fracture is the flat sap, especially the lighter models, such as the "Midget" or "Junior" made by Bucheimer in Frederick, Maryland. If the officer works uniformed patrol and normally carries a full length baton, he might want to carry one of these light saps for those occasions when the baton is inappropriate or accidentally left in the car. The round sap can strike to either side as well as front and back. It is also easier to "choke up on" for thrusting blows to solar plexus or chin. It is more likely to lacerate than the flat sap. The lightest,

The "Gestapo" spring cosh (left), closed, compared with the Ni telescoping baton (right), also closed. The Ni device, has a quillon to protect against knife attack,



most convenient sap on the market is the Bucheimer 8980, a six-ounce round sap, which can be completely concealed in the pocket without noticeable bulge, an advantage to plainclothesmen. The shot-filled and lead clay saps allow some "give" at the moment of impact, possibly spreading out the impact of the blow. The Bianchi Model 39 (made in Temecula, California) also has the advantage of being completely filled with lead. With this type of sap the handle as well as the pod can be used to strike blows. Also, this type of sap is more acceptable to those who do not like the spring-whip of other types. The Bianchi sap can be used to strike flat blows, short thrusts (choked up), and slashing blows with the side edge.

If carried in the back pocket or special sap pocket with its end sticking out, the blackjack can be snatched away more easily than a conventional baton (of course, in this case the officer could be justified in using his sidearm since the suspect is now armed), so the officer may want to consider a sap that can be concealed completely. The main drawback to the blackjack, however, is its flexibility. It cannot be used to parry a weapon or to strike full-length thrusts. Its main advantages seem to be concealability, convenience, and less risk to the suspect.

Aside from its flexibility its main disadvantage is its short reach. Even so, it can be effectively used against targets like the knee or ankle (with training), targets which can incapacitate a suspect while requiring little treatment, which can be explained away if necessary (e.g., "He must have bumped into a chair or fallen down while I was struggling to restrain him"). Blows should not be directed at the head, face, or neck, un-

less there is no other target available, and the suspect must be stopped immediately.

The blackjack can be a useful weapon to the detective or plainclothesman who cannot carry a baton. No policeman should go out with only a gun. A pistol is an effective weapon, but its use is all but precluded by a host of laws and policy directives. The butt of a folding knife, a yawara stick, or a blackjack can help bring a suspect into custody when the mere threat of a revolver will not. The revolver itself should not be used to strike blows, since this can make it inoperable.

One alternative to the blackjack is the yawara stick. In professional police models this is an eight-inch cylinder of plastic or aluminum, one inch in diameter, usually with a device such as a spike or sharp ring, to prevent its being snatched away. The Yawara has become fairly popular since F.A. Matsuyama introduced his back in 1947. Monadnock Lifetime Products in Fitzwilliam, N.H., makes several types of plastic yawara sticks including some with chrome steel balls on the tips (which unfortunately increase the lethality of the device; these balls focus the force of the blow to a much smaller area than would a conventional stick or blackjack, making them likely to penetrate the soft parts of the skull). An aluminum "judo stick" is made by Kel-Lite/Safariland of Monrovia, California.

A simple yawara stick can be made from an ordinary wood dowel — just cut it to five, six, seven, or eight inches, depending on the width of your hand, so that an inch sticks out above and below

the hand. The yawara stick can be used to strike forward or backhand against nerve centers and joints, and, when used in combination with feints and parries with the left hand, it can provide a remarkable measure of protection against the attacks of an unarmed man.

Next up from the blackjack and yawara stick is the billy. This is a short baton, usually 10 or 12 inches long. Modern billies may be made of wood, plastic (such as the Monadnock series), or aluminum (such as the Kel-Lite billy). The billy, since it is rigid, not flexible like a blackjack, can be used for a number of one-hand parries, jabs, and blows, limited only by the imagination and training of the user. It is the most versatile stick short of the conventional 18 to 26-inch baton.

One type of blunt instrument which fits no simple category is the telescoping baton. This may be either flexible or rigid. In either case the telescoping baton is made up of a six-inch root tube and two shorter, thinner tubes which pop into place by gravity or spring tension. The earliest one, attributed to the Gestapo, or Nazi secret police, used a solid root tube and two flexible coil-spring tubes, which popped out like a car aerial with a flick of the wrist. The tip of this device might be solid steel or it might be weighted with cast brass. It is used in the same swinging manner as a blackjack, but since it has no padding, and because of its much longer arc of whip, it is much more lethal than a blackjack.



An early set of adjustable cuffs shown with a vintage lead-loaded sap. This sap is identical in design with many roundhead blackjacks. Some departments now prefer the flat sap since it is less likely to lacerate than this old-style round sap.

In fact, the Gestapo baton's propensity for penetrating a skull made it a favorite silent assassination weapon of the underground. Incidentally, the same type of coil spring (not telescoping) was used in the light whip of female guards at German concentration camps, with which they were reputed to be able to deftly pluck out an eye. The Gestapo "spring cosh" is not in general use today, but the example shown was the property of a modern German policeman.

The second type of telescoping baton, or "extensible nightstick," is the rigid variety, made of three solid steel tubes. One of these, called the *tokushu keibo*, is manufactured in Tokyo and is worn by airport security police among others. The private army organized by the late Yukio Mishima, noted author, ultrarightist, and suicide, was armed with this device. The Japanese policeman does not find the idea of a steel truncheon to be

keibo, and its most popular variation is a spring-loaded model which shoots into position at the touch of a lever. It also has a substantial quillon to ward off knife attack. The only drawbacks to this device are that the chrome finish tends to rust, and pounding the device on the floor (necessary to close it) may dislodge the soldered-on tip. I once tried to interest several arms people into importing this device, but their test marketing showed that most American policemen feared its "secret weapon" image which they felt could adversely affect public relations. Practically every policeman I saw in Taipei had one of these, and folded into its leather carrier it is so inconspicuous that if I hadn't known what to look for I would have missed it — only a criminal assailant would see it in its "fear-inducing" position. It is certainly less conspicuous than a 26-inch baton banging on the hip.

standard baton, while adding the versatility of a practically indestructible flashlight. The shorter models can be used in place of a conventional blackjack or billy. In fact, these have become so popular that policemen often refer to them as their "electric sap."

A variety of objects can be used as improvised batons or blackjacks. The list includes ballbats, flashlights, towel racks, bunk adaptors, tree limbs, socks or handkerchiefs filled with sand, gravel, quarters, or lead shot. In the LAPD Archives I have even seen an improvised blackjack that one old time copper made from a bent horseshoe — quite an intimidating sight.

A weapon is only as effective as the training that goes with it. Since most departments do not offer much in the way of baton training, if a policeman wants to become really proficient, he should study some relevant martial art. The most valu-

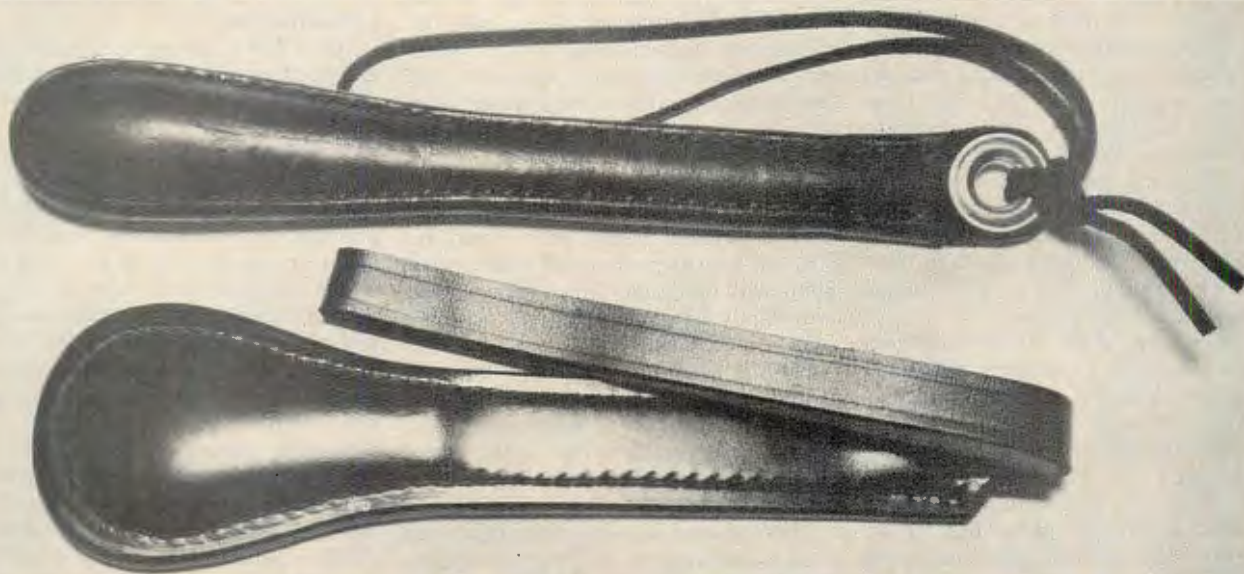

Above: the Bianchi Model 39 sap, 10 inches of leather-covered lead clay. The thong, a simple shoelace, can be removed and tied around the thong ring. Below: the Bucheimer "Denver" flat sap, a smaller brother to the

famous "Texan" model. This is the typical solid-lead-pod-with-steel-flat-spring covered with leather, a good slapper sap but less versatile than the Bianchi design.

repugnant, as does his American counterpart, perhaps because old feudal Japanese policemen were equipped with the *jutte*, a short metal wand which could even ward off sword attacks. Also, Japanese policemen are far better trained in the use of their stick weapons, so that a device which compresses its blow to the narrower confines of a metal tip can be trusted in their hands. Tokyo policemen, for example, practice three times a week with baton and *shinai* (bamboo practice sword used in *kendo*). In America, policemen rarely train with the baton after they get out of the academy, even though this is their *primary* weapon, their first line of defense, a weapon used far more than the handgun.

Incidentally, another rigid-type telescoping baton is made by Professor Ni of the Central Police College in Taiwan, a man I met a few years ago in Taipei. His device is slightly larger than the *tokushu*

The conventional 22 or 26-inch baton is an excellent weapon. Its length allows two-hand as well as one-handed attacks, useful for retaining a secure grip on the weapon at all times. It can be used to parry, thrust, beat, and slash with a variety of moves adapted from saber fencing, *kendo*, *ju-jitsu*, *kali*, *escrima*, or a number of other martial arts. Its only drawback is its length and conspicuousness. London and Hong Kong police are satisfied with a 10-inch truncheon. Tokyo and Taipei police often carry only the telescoping baton.

One compromise that combines length with less conspicuousness is the police flashlight. This device, made of aluminum (such as the Kel-Lite) or plastic (such as the Pro-Lite, which picks up most of its weight from its batteries), comes in a variety of shapes and sizes. The 18, 22, and 26-inch Baton-Lites made by Kel-Lite virtually take the place of a

able, practical art that I have come across is *escrima*, the Filipino art of stick and knife. Unfortunately, there are few *escrima* schools outside Hawaii and California. You might also look into some of the Chinese martial arts schools, as they stress the use of stick techniques as well. An excellent Super 8mm training film on the use of the police baton is now available from Harold Brosious (290 Verde Vista Dr., Thousand Oaks, Ca.) My own book on stick fighting will be available soon from Phoenix Press (Box 693, Boulder, Colo.), publishers of my last book, *Secrets of Modern Knife Fighting*. The stick fighting book will detail techniques for using the baton, blackjack, and related weapons, as well as offer heretofore unprinted photographs of vintage police weapons.



FOR MERCS & SOF'ERS ON THE ROAD OR IN THE BUSH HOME DRYING JOURNEY FOOD

BY EDWARD BROWN

Ever since the first restless men left the familiar confines of their home grounds to venture into unknown territory, one of the greatest problems the wanderer had to face was maintaining an adequate food supply for the trip. One solution was, and is, foraging and hunting along the way, but if the new land is truly *terra incognita*, there can be no reasonable assurance of subsisting off it.

To give himself an even chance of survival, the early explorer had to devise ways of preparing food in advance that would make for compactness, nourishment, and "longevity," which is to say that his food had to have the staying power to last and remain eatable under all circumstances and weather conditions.

It's a tribute to primitive man that the processes he developed with few tools and little knowledge for preparing expedition-type food — principally drying, salting, and pickling — have come down to us with little basic change. Despite today's technology and know-how, we haven't been able to improve to any great degree upon these pre-Biblical practices of food preservation.

Moderns can, then, take a leaf from early man's book to prepare nutritious food that will travel, and as a further dividend can prepare it at home at a fraction of the cost charged by commercial outfitters.

From the time our shaggy ancestors first got their canines into a slice off the joint, man has been a confirmed meat eater, preferring this form of protein over any other single food for its taste, and muscle-building and energy-giving properties. It's not surprising, therefore, to find his earliest efforts at preparing journey food centered on preserving meat.

And that brings us right up to the present with the old standby, beef jerky, famed of outback, mountain pass, and cocktail bar. There must be a couple of dozen ways to prepare jerky, using the sun, making a drying house of willow sticks, or whatever, but for the purposes of this article we're going to stick to the simplest technique consonant with the end result of tasty and nutritious food.

The rationale behind the process of preparing jerky is that by removing by heat anywhere from 80 to 90% of the water content of meat, and reducing the bulk by roughly one-third, those organisms which can cause spoilage in untreated food are removed, so basically the preparation of beef jerky involves striking a balance between applying just enough prolonged heat to adequately dry the meat, but not cook it.

Here's how it's done:

(1) As raw material, use a good grade of mature, lean meat — a shoulder cut of beef or venison works well — and cut strips as long as possible out of the meat, going with the grain. These strips should be roughly one inch wide and no more than 1/2 inch thick.

(2) Mix salt (one tablespoon for each pound of meat), garlic powder, pepper, and any favorite herb which goes well with meat — parsley is one — and pound these seasonings into both sides of the beef strips, using a mallet or rolling pin.

(3) While you've been doing this, your oven has been preheating to 150 degrees. Put the strips on an oven rack, one deep, and as soon as you get them into the oven, turn the heat down to 120 degrees. This is low, and many ovens won't go down this far. Get yours as low as you can, but if it's a bit higher, put your oven rack well up from the oven bed.

(4) Now comes the waiting game. Leave the meat in the oven for four or five hours, with the door propped open an inch or so, more if your oven is hotter than 120 degrees.

(5) Five hours into the game, turn the strips over and carry on as before for another three or four hours. Begin checking for dryness after allowing a stick or two to cool first. The jerky by this time ought to be shriveled and black and should break like a green twig, not a dry one.

(6) Store the finished jerky in the fridge until you're ready to use it, then take it along in a plastic bag inside a nylon or cotton stuff bag.

Dried fruits, also prime energy givers, and good travelers under any conditions, are something else well worth the time to "tailor make."

In preparing dried fruits there are some general principles best followed. For one, always use wooden trays for the process, never metal. A cheap way to make drying trays is to get hold of the crates produce comes in at the local market and saw into sections a couple of inches deep. No metal on the bottoms either — two layers of cheesecloth or other woven cloth over wooden strips works well.

Second, always use the freshest fruit and the best grade you can lay hands on. Cut thin — this makes for better drying. After the process, store the dried fruit in closed containers in a dry place until ready for use.

Again, for simplicity we're going to describe a fruit-drying process which involves the standard kitchen oven. There are procedures using the sun, and/or complicated drying trays, but these are outside the scope of this elementary how-



Apples and pears in the process of being steam-blanching preparatory to the drying phase of the process. Steam blanching of both fruits and vegetables is necessary to inhibit the decomposing action of the enzymes and to loosen plant tissues. Five minutes is enough for these two fruits.

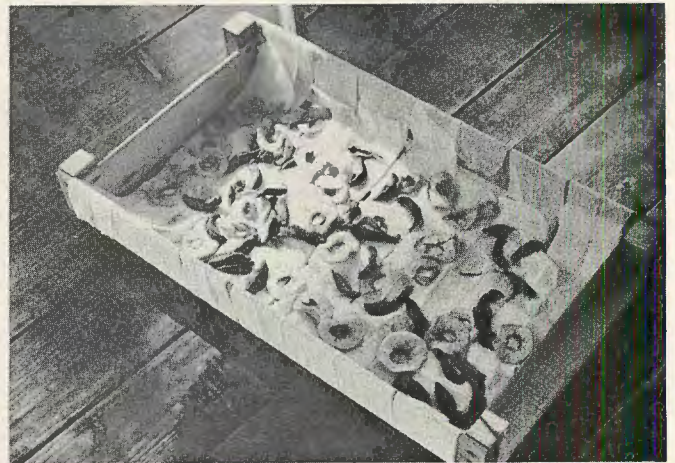

Apples and pears after the drying process and ready for pasteurizing. The drying tray (which went right into the oven) is the bottom section of a vegetable crate, lined with surgical gauze.

to-do-it piece. If you decide to get serious about home-drying fruits and vegetables, the July 1977 issue of the monthly *Better Homes and Gardens* has a good set of plans for a drying box made out of ½-inch plywood, ¾-inch pine, and four light sockets on page 18.

If you've got an electric oven, disconnect the upper element and be sure to vent the oven well during the drying process by leaving the door ajar. If you can't get your oven down to 140 degrees, set it as low as you can and open the door a foot or so. Remember to put your drying trays well up from the oven bottom.

In preparing dried fruit, there's a process known as "blanching" which must be effected during the processing. Blanching involves treating the fruit to be dried with steam in order to minimize the decomposing action of the enzymes in the fruit, maintain the color of the fruit, and promote drying by loosening the plant tissues.

To steam blanch, first heat half a pot of water to boiling and arrange over it a rack just high enough to miss the sputtering water. Put a layer of fruit on the rack no more than a couple of inches deep, and let steam. Be sure the steam gets to all parts of the rack. Test a center piece — it should be soft and thoroughly heated when done. Steam-blanching times for each fruit are given in the individual preparation directions for that particular fruit. When finished, spread the blanched fruit out on a paper towel and let dry.

Now let's make some dried fruit:

A favorite for taste and pick-me-up qualities is the apricot. Get a couple of pounds or more just before they're ripe enough to fall from the tree of their own accord, halve them and remove the stone, but don't worry about peeling them. Steam-blanch the apricot halves for 15 minutes. Roll them in paper toweling and start their oven treatment at 130 degrees. After one hour, raise gradually to 150 degrees. After half a day (literally — 12 hours) test them. Apricots should "test dry," which means there won't be any more than 10 to 20% water left in the fruit. When squeezed, no water drops are in evidence, and the fruit has a pliable and fairly tough feel to it. Again, as in the case of checking out beef jerky as a

finished product, allow the fruit time to cool before doing any testing.

Authorities recommend Baldwin, Ben Davis, Winesap, Rome, and Delicious apples as best for drying. Slice whatever apple you're using into ¼-inch peels and steam-blanch for five minutes. Wipe off excess moisture and start them off in an oven at 130 degrees. Raise this temperature gradually to 150 degrees after the first hour. When nearly dry, lower oven temperature to 140 degrees. Six

hours total should be enough to properly dry the fruit.

Freestone peaches are a good choice for home drying and are best dried by halves rather than by slices. Strip the skin and steam-blanch halves for 15-20 minutes. Begin the oven temperature at 130 degrees, and raise gradually to 155 degrees after one hour. Rotate halves when visible juice has dried and lower oven temperature to 140 degrees during the last part of the process. Peach halves take a while to dry — 15 hours total, so be ready for a long process here.

Bartlett pears are a good bet for drying. Cut down the middle and take out the core with a melon ball scoop. Work with slices or halves as you prefer. Steam-blanch slices five minutes, halves 20 minutes. Begin with an oven temperature of 130 degrees, raise after the first hour to 150 degrees, and lower to 140 degrees for the last hour or so. Slices take six hours, halves 15.

Even though you are sure your dried fruit has been properly prepared and is ready for the eating, it's a good idea to make absolutely sure by taking the process one step further and pasteurizing each batch.

Preheat the oven to 175 degrees and lay the fruit out on trays. Aim for a one-inch depth of fruit, no more, and don't try to pasteurize more than two trays at one time. Leave the trays in there for 15 minutes, then spread out to cool on paper toweling.

Before packaging dried fruit, be sure the product is completely cooled. Dried fruit even slightly warm will sweat in plastic bags. Paper bags or the ubiquitous plastic bags are good for storage. Put the bags somewhere away from the mice in a cool and dry place.

Then when you're getting ready for your next merc or soldier of fortune foray, just go to the pantry and take out the goodies you've stored there. If you've done it yourself, as our forefathers did, you won't need so many long-range patrol rations or to spend so many bucks for commercial freeze-dried products.



TWO SIDE DISHES

A couple of excellent emergency foods which can be tucked in a corner of a pack or survival kit are Pinole and Logan bread.

PINOLE

Pinole is an old Indian travel food — very durable, light, and nutritious. A pound of pinole will keep one on his feet and moving for a week. Pinole is simply fancied-up parched corn. To make it, shake out a pint of dry, sweet garden corn in a baking pan and put into an oven heated to 350 degrees. When the corn is a light brown, sprinkle two heaping tablespoons of brown sugar on top and return to the oven until the sugar begins to melt. Cool and grind in a food grinder. If you have no grinder, put in a couple of plastic bags and attack with a rubber mallet. Store the pinole in a plastic bag inside a nylon stuff bag. When eating, wash down with water — you'll think you've had more than you've gotten.

LOGAN BREAD

Logan bread has been described as "hard as a rock (igneous), dry, and light," and is an Alaskan recipe. Incidentally, this recipe makes a platoon-sized portion, so if you want less, cut down on the ingredients proportionately. To one quart of water, add: 4 lbs. whole wheat flour, 12 oz. melted shortening, 12 oz. natural sugar, 1 lb. honey, 1 lb. blackstrap molasses, 4 oz. powdered milk, 1 tsp. salt, 2 tsp. baking powder. Nuts added as desired. Mix and bake at 300 degrees for one hour, dry out well for several hours with low heat and oven door open a crack.



A two-pound chunk of meat ready for the slicing. This is what housewives call "London Broil" and is convenient for making jerky because its thickness is a bit over an inch or so.



Partially sliced for the oven. Care should be taken to cut the meat in the longest strips possible. After drying, they'll shrink down to a reasonable size.



Next stop, the oven, preheated to 150 degrees and lowered almost at once to 120. Oven door is left ajar to facilitate drying and prevent too much heat buildup.



Lurking behind the unsuspecting sentry, Echanis observes the timing and movements of his target in order to pace his actions with those of the sentry.



Keeping low to avoid entering his target's peripheral vision, Echanis, stepping softly, approaches the sentry.



Echanis prevents the sentry from shouting by clamping his left hand over both mouth and nose. The right hand goes to the sentry's throat, applying direct pressure to the windpipe and voice box.



Echanis spins the sentry around, breaking his balance and disorienting him. Notice that Echanis moved away from the sentry's gun.



With sentry's balance ruined by spin, it is easy to dump him. Note that Echanis maintains twisting pressure against sentry's neck and head; pressure from thumb and fingers on windpipe.



A detailed view of just where pressure is being applied and grip used to cut off air and blood supply to sentry's brain.



Extending his left leg under sentry, Echanis slams his knee into sentry's head; shifts his hands to sentry's hair, to keep sentry disoriented and prepare time for next move.



Echanis delivers the coup de grace (if the sentry is not already dead) as he slams raised right leg into the sentry's throat. He maintains pressure until sentry's life signs are no longer visible.

SENTRY REMOVAL

Art Gitlin/Mike Echanis



Leaning back but without releasing his grip on the sentry's hair, Echanis raises his right leg high.



After dragging his handiwork down the bank and out of view Echanis is free to do whatever it was that he had in mind when this all started. Guard duty never was much fun.

AND THEY WERE THE PROS?

(continued from page 30)

corner of the main room the Cubans had created a small shrine in memory of the men who had been killed or lost on earlier missions. It seemed to exemplify the camaraderie within the commando team and their profound dedication to their cause.

In the morning, everyone waited in line for the toilet. The sanitation facilities on the island were limited: there was no shower, and fresh water had to be conserved. No one bothered to shave, and bathing was done in the sea. Two weeks or more of island living presented personal hygiene problems, but most of the Cubans had adapted to the hardships.

Training did not begin until mid-morning, after all the housekeeping chores were done. The first session, a review of basic weapons, was conducted in the large central room of the old house. The class was presented quite informally, in Spanish, by one of Turk's assistants. The commando team had been issued a variety of individual weapons, including Colt .45 pistols, M-3 submachine guns, Thompson submachine guns, .30-caliber carbines, AR-15 rifles, and standard M-1 rifles. Turk said the weapons had been obtained through Canadian or other foreign sources and could not be traced to the United States Government. Most of

Turk's team already understood the mechanics of the weapons, but while the class was going on, there was a lot of chattering and fooling around with the weapons. The Cubans seemed to enjoy the image of commando freedom fighters and acted out their roles with humorous bravado; some of them even wore their weapons and cartridge belts Mexican-bandit style. I wasn't ready to criticize this; I realized that the guerrilla image could be essential in maintaining high morale among the exiles, and to suppress their childish enthusiasm might destroy their will to fight.

The afternoon training session included instruction in the use of six-man rubber boats, and I had my first look at the Boston Whaler, a rather unique fiberglass boat which was well suited for rugged use. The Whaler was shaped like a small barge, and Turk said it was virtually unsinkable. It had a shallow draft hull with a tri-V configuration to give it stability on rough open seas. The commandos used the standard commercial Whaler without modification, either the 13-foot three-inch version or the 16-foot seven-inch model. The boating class was presented by another of Turk's assistants and, once again, there was a lot of horseplay and the instruction was disorganized. Finally the team tipped one of the rubber boats, spilling everyone into the water, which provided an excellent excuse to halt the training and go for a swim.

Later on, Turk showed me their newest piece of equipment, an item called a "silent" outboard motor which was about 50% quieter than a standard outboard. The Navy had developed it for UDT missions and other clandestine activities. The motors were not available through civilian channels. They were made by the Johnson Company in several sizes. (Turk's men had a ten-horsepower and a 25-horsepower model.) The motor looked like no other outboard I had seen. It was painted a dull Navy gray and had a regulation military appearance.

The evening's exercise was a rehearsal of a proposed raid to destroy a railroad bridge in Cuba. Although the mission was not yet approved by Headquarters, the team had spent several weeks preparing for it. There was no railroad bridge on Elliott Key, so the commando team had constructed a crude mock-up out of barrels and driftwood planks back in the mangroves.

They had rehearsed the raid several times, so no premission briefing was given. As soon as it was dark, the 12 Cubans donned their equipment and went down to the dock. I watched the men climb into two six-man rubber boats, which were towed from the dock by the Boston Whaler and released several hundred yards off shore. This action simulated the release from the mother craft.

While the commandos were paddling the rubber boats ashore, Turk and I walked through the mangroves to a prearranged landing point about a half mile from the house. We hid in the dense vegetation and watched the raiding party come ashore and conceal the rubber boats. Although the men had paddled the boats quietly, once they were ashore they completely disregarded noise discipline. Talking and the clanking of equipment would have given away their position quickly in the real situation.

Keeping ourselves out of sight, we followed the commandos to the mock-up railroad bridge. The team moved quickly, but, again, there was too much noise. They would never have made it if there had been reasonably alert guards on the bridge. The attack itself was disorganized. There was no base-of-fire element, no provision for security, and apparently no basic tactical organization as I had known in the military. The entire raiding party walked straight to the objective and set the simulated charges (small cans of gasoline), and when the charges detonated, everyone scattered. No rallying point had been established, and, as it turned out, two team members failed to show up at the rubber-boat site for the return to the mother craft.

Confusion reigned. Finally I went back to the mangroves and found the two frightened, embarrassed Cubans who had become separated from the withdrawing force. Reunited, the team paddled back along the shoreline to the dock in front of the safehouse. Turk said little

HEARTS & MINDS

T-



When You've
Got 'em
By The
Balls...
Their Hearts
& Minds
Will Follow!!

SHIRT

\$4.95

PLUS \$1.00 SHIPPING AND HANDLING/CASH OR CHECK ONLY

ORDER YOURS FROM
PARAMILITARY MARKETING
AND WILDERNESS OUTFITTERS
P.O. BOX 662, ROSEMONT, IL. 60018

NAME _____

ADDRESS _____

CITY _____

STATE _____ ZIP _____

PLEASE STATE
SIZE AND QUANTITY

L	M

on the way back, and I was sure he was ready to light into the commandos for bungling the rehearsal, especially in the presence of visitors. From my military viewpoint, the exercise had been almost humorously amateurish. But when we returned to the house, Turk said nothing. There was no critique and no after-action commentary. Instead, the men immediately devoured an enormous stack of sandwiches and black coffee. They didn't even bother to clean their gear, and as soon as they had finished eating they went to bed.

I lay awake a long time that night, not able to accept what I'd seen. Turk, as the case officer in charge of the team, was obligated to correct their tactical errors. These men's lives, and the success of their missions, rested on his ability to train them. To allow the exercise to become almost a farce and to ignore the blatant errors which in the real situation might have gotten them all killed was, I felt, a serious oversight.

Following the tour of the Elliott Key base, I went to Point Mary in North Key Largo where another commando team was established in a safehouse-training base in an old fishing camp. There was no American case officer immediately in charge of the group and I introduced myself to Julio, the Cuban team leader. At first, Julio looked confused and I quickly explained that I'd come to observe the training of his commando team. I was pleased to discover that Julio spoke excellent English. He told me that he was the commando team leader.

Julio took me on a brief tour of his base. It was not nearly so secure as Turk's island hideaway, but it was accessible by a good road from Key Largo, which greatly reduced the logistical support problem. It was only about 200 yards from a small subdevelopment of vacation homes, some of which were occupied year round. Although the safehouse complex was surrounded by fairly heavy vegetation, I wondered how the team's activities could go unnoticed by the neighbors. When I asked Julio about this, he said they tried to be very careful, and thus far no one had paid any attention or bothered them.

There were two old wooden buildings at the site; one served as a bunkhouse, and the other was a combination mess hall, classroom, war room, bar, and recreation room. Individual supplies were stored in open sight in the sleeping rooms, and large pieces of equipment were stored beneath the floor in the mess hall. A small shrine in memory of the fallen team members, similar to the one at Turk's, stood in the corner of the main room.

Julio's exiles appeared to be much like the men I'd observed at Turk's, except they were older. Julio explained that his commandos had been fishermen, farmers, and soldiers in Batista's army. My

BODYGUARD & Mercenary Functions Provided



A Manual on Bodyguard, Assassination, and Harassment Techniques Includes

Defensive Weapons of the Bodyguard / The Bodyguards Life and Responsibilities / Assassination Methods and Weapons / Guerilla Warfare Tactics / Chemical and Explosive Formulas for Harassment / Security and tricks of the trade used by professional bodyguards.

Mail \$4.95 +.50 (First Class Postage To:)

LUPI P.O. Box 5644 Augusta, GA 30906

first impression was that they didn't have the spontaneity and high spirit that Turk's men had; they seemed more mature and resolute. I tried to speak with several of them, but I found that no one besides Julio spoke English. Nevertheless, I felt more comfortable, and less like an intruder, than I'd felt with Turk's men.

Later that day the men gathered in the classroom. After a few introductory comments, Julio turned the meeting over to one of the older men, who gave a class on knot tying. During the course of an hour he reviewed five or six basic knots. The presentation seemed good enough, but he passed one long rope around instead of giving a small piece of line to each of the men, which I thought would have been a better training technique.

I was awakened early the next morning by the crack of a rifle. Sitting up, I looked around to see Julio still sleeping soundly. Racing outside, clad only in my shorts, I heard another shot. I walked in the direction of the sharp report, but just before I reached the rifleman, Julio caught up with me.

"What the hell is going on?" I asked, incredulous.

Julio laughed. "It's just our sharpshooter doing his daily marksmanship practice. He shoots the sea ravens . . . you know, the cormorants . . . that rest on the mangrove roots to dry their wings."

As we returned to the safehouse, Julio explained that the sniper was rehearsing

for the day when he could center the cross hairs of his telescopic sight on Fidel Castro. Julio seemed unconcerned that the morning target-practice sessions might destroy the fragile security of the safehouse complex.

Later, while we were eating breakfast, the sniper came into the mess hall and told Julio he'd killed three cormorants at a range of nearly 500 yards. Julio smiled proudly and complimented him.

My CIA escort, Bob, drove up as we were finishing breakfast and told me to get ready to go to another location to observe more training. When we left, heading north toward the overseas highway, I asked about Julio's group and learned that the team was supervised by Bob himself. But from time to time a man called "Colonel" John Roselli, who worked out of CIA headquarters in Washington, used the team for raids and other clandestine operations. Roselli, like Turk, was one of the few Americans authorized to actually go on commando missions into Cuba.

Bob admitted that he depended heavily on Julio to run his operation, and he recognized that lack of supervision at the safesite resulted in some waste of time, as well as poor security. In response to my continued prodding, he confirmed my belief that neither he nor Turk allowed anyone else to exercise any great degree of influence or control over their groups,

even for the purpose of training. It was obvious to me by then that they'd created their own little "commando empires" and that trying to work with them could pose real problems.

Bob wasn't aware, or pretended not to be, that Julio's team was doing target practice with live ammunition, and although he cursed when I mentioned it to him, he said nothing about correcting the situation. Sensing that he wanted to change the subject, I asked him to tell me about his responsibilities as a case officer. He said that he, like others, handled the administration and logistical support for one or more exile teams. He also recruited them, scheduled their training, and looked after their personal needs, much as an infantry squad leader would do. He was the key man in influencing the team's actions and behavior and, ultimately, was the person who would have to be convinced of the need for improvements in the training.

I was especially concerned about logistical problems. Bob explained that when an order of supplies or piece of equipment was too large to be transported in the trunk of a case officer's car, the logistics branch arranged for a rented truck or commercially marked van to deliver the supplies directly to the safehouse. In cases where a safehouse was inaccessible by road, the items were taken to a clandestine boat-landing site and transferred, in innocuous-appearing containers, to a boat or ship which would make the delivery.

As we drove through the town of Homestead, Bob told me that I was going to observe a newly recruited and organized intelligence team receiving instruction in tradecraft.² We traveled a few miles on Quail Roost Drive, then turned down a narrow dirt road and stopped at a low blue stucco house surrounded by pine trees. Bob introduced me to a tall, husky man named Greg, then said goodbye and left.

Greg took me into the house, where three Cubans were seated before a blackboard, and a short, elderly man whom Greg introduced as Otto was giving instruction. Otto spoke with a heavy German accent, and his presentation was translated into Spanish by another Cuban. Greg explained that the men in the class were training for a secret landing on the Cuban coast. Once ashore, the team would go back into their home province, establish a clandestine radio transmitter, and send raw intelligence back to the station in Miami. They would stay in Cuba indefinitely, living "black," which meant that they would live completely in secret, without attempting to use cover or risk any exposure. Greg had less than three weeks to prepare the three-man team for this secret, hazardous existence. It was a dirty, tough, highly dangerous mission but representative of the intelligence-gathering operations conducted by the CIA.

I spent the rest of the day listening to the classes. Greg said the team was typical of the exiles being recruited: None had any previous military training, and although they were in their mid-twenties, they were not in good physical condition. One man had been a waiter, another a musician, and the third a bank clerk. When I asked Greg what their chance of success would be, in view of their training, he just laughed, which made me wonder about the Cuban volunteers, for certainly they must have understood the odds against them.

As Greg drove me back to my motel that evening he told me that he had been working with infiltration teams for a year in Miami. He stressed the fact that most of the recruits were highly dedicated but pitifully inexperienced. Almost without exception, they needed far more training than the station was providing.

A week earlier, I wouldn't have believed that my room at the Mariner Motel could ever be a welcome sight. But

that night, physically and mentally fatigued as I was and badly in need of a shave and a shower, the room seemed like a haven. I tried to organize my many impressions of the past week. I hadn't been prepared for the inadequacies I had seen in the program; naively, I had expected too much from the Agency. The week had been unsettling; I could see that making a meaningful contribution to the cause was going to be a greater challenge than I had imagined.

With renewed interest and determination, I went ahead with my tour of training activities. In the days that followed I again observed Greg's work with the infiltration team. Successful land and sea navigation was vital to the team's mission, and Greg spent several days teaching them to use a simple magnetic compass. They seemed uninterested in the technical explanations and had trouble comprehending the workings of the instrument. They didn't trust the compass to determine direction and location. I observed a compass exercise at night, and the team got hopelessly lost. Greg finally found them at about midnight, exhausted, discouraged, and confused, standing in front of the Orchid Jungle, a tourist attraction. Fortunately, no one else had seen them.

I made detailed notes of my observations and spent several evenings recording my earlier observations on Elliott Key and Key Largo. When I felt I had a firm grasp of the tradecraft program, I arranged to visit the small-boat training conducted by the maritime branch at Flamingo.

An isolated, very luxurious house on the edge of the Everglades several miles from Homestead was the base of operations. Perry, a former Navy warrant officer, was responsible for the small-boat training. He had been working with two-to five-man infiltration teams for nearly a year. Small-boat training had been non-existent until he joined the station and

NEW LDP 9mm PARABELLUM PISTOL

- Ideal for household use and defence
- practically no recoil
- portable and simple for women to use
- designed for both left and right-handed persons
- S.A.B.S. proofed
- safety features include a unique sear which prevents the weapon being fired accidentally should it be dropped
- with its pre-set sights, the LDP is accurate, for a man-sized target, at 100 meters and at 50 meters for a 100mm target

Enquiries to:

FIREARMS INTERNATIONAL

P.O. Box 781226, Dept. SF, Sandton, 2146 Tl., Republic of South Africa
Telephone: 672-8207. Cables: EXIRAN FLORIDA R.S.A.
Telex: 80023 S.A. JOHANNESBURG

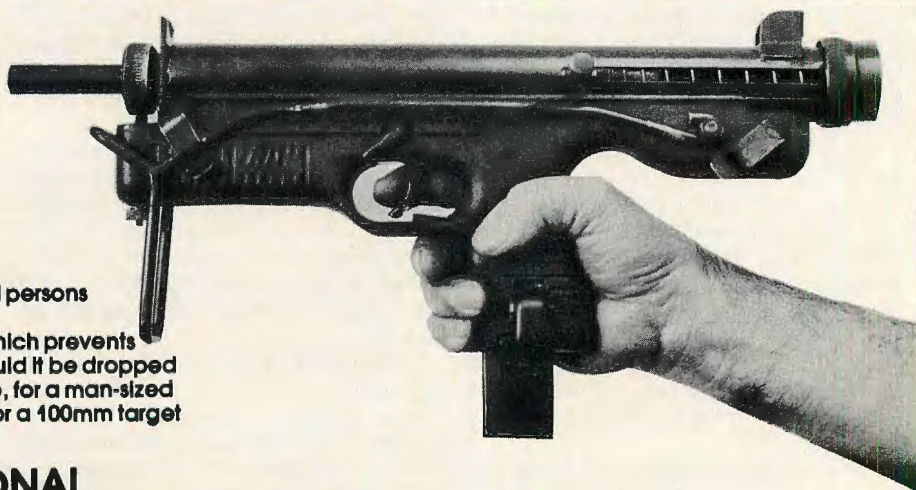

put the present program together from scratch. I was impressed with his sincerity and personal involvement as he emphasized that the seaborne phase of infiltration was almost totally beyond the control of the station or any American case officer. Once a team was released from the mother ship and placed aboard smaller boats, they were on their own. Under the cover of darkness, and sometimes under unfavorable weather conditions, the teams had to navigate, usually by dead reckoning, to either a primary or an alternate site on the coast. If they reached shore safely, they had to conceal their craft before moving inland. In most cases the boats were sunk or camouflaged in the mangroves but were kept in seaworthy condition. This was extremely important, because escape by sea was the only way a team could expect to leave Cuba. Because of increased surveillance by Castro since the missile crisis, more and more teams were being discovered or compromised. Without a means of evacuation, they would likely be captured, tortured, imprisoned, and ultimately shot.

If an infiltration team became aware that capture was imminent and if they had some means of communicating with the Miami station (clandestine radio, secret mail, reports through other agents or exiles who had escaped), a rescue could be requested and attempted. On a few occasions false documentations, credentials and an emergency cover could be established for an agent in an effort to bring him out through diplomatic or commercial channels, often through a foreign country. Sometimes an

inventive, imaginative agent would suddenly turn up in Spain or Europe, apparently from nowhere, long after he had been given up as missing.

But in most cases, Perry explained, the infiltration team would call for a "black" emergency evacuation. A ship, and a commando squad if there were wounded to be brought out, would be sent to a prearranged location off the Cuban coast. The fleeing team, sometimes with Castro's men and dogs hot on their trail, would go to the previously concealed boat or boats, recover or inflate them, and, under the cover of darkness, make their way to the CIA ship lying somewhere off the coast. Many things could interfere with this sort of operation, and more often than not the rescue ship would return empty. Perry emphasized that every effort was made to get a team out, even if it meant keeping the mother vessel in the dangerous coastal waters for several days. There was always the possibility that the team might show up the next night, or the next, or the next. In a very few instances, teams escaped in small boats and managed to make it on their own back to Florida or to some Bahamian island.

From Perry's remarks, it was apparent that the recovery of an endangered team was of the highest priority to the station. Therefore, Perry spent a lot of time teaching the men to use the radio direction finder (RDF) so that they could, if necessary, home in on the mother ship at night. Teaching the RDF, navigation and map reading, and the mechanical functioning of boats and motors presented the biggest problems. Most of the Cubans had

had no experience with maritime navigation or the relatively sophisticated boats and equipment the CIA provided. However, to successfully compete with the increasingly proficient Russian equipment of the Cuban forces, it was essential that the exile teams learn to use the better equipment.

Perry gave all the instruction himself. He had no Cuban assistants, nor did he employ a full-time interpreter from the station. The former Navy instructor said he would like to have a team for about two weeks.

All of the classroom instruction was given at the secluded Homestead safehouse. The group traveled daily to Flamingo, where Perry kept his training boats; there, the team practiced what they had learned in their classes.

Seldom did a team get the full two weeks of training that Perry wanted. Most of the groups came to him on a "crash" basis, with specific instructions on what type of craft, navigation, and landing procedure they would use. Such was the case with the group scheduled to begin small-boat training that morning.

The Cubans—two sturdy men in their early thirties and one elderly black fisherman—were brought to the Homestead safehouse by their case officer, a fat, greasy man with a pockmarked face and thin gray hair. The officer explained that the men were being sent to Cuba covertly to gather intelligence in their home province in the Santa Clara Mountains. There were rumors of rising anti-Castro sentiment there, and the CIA needed more information in order to provoke and exploit the unrest. The three-man team



YES!!!

I WANT TO WEAR THE GENUINE S.W.A.T. T-SHIRT!

(Autographed by S.O.F. Editors Ludwig Nicholas Ladas II and Robert Allman)

ORDER TODAY!

ONLY \$5.95 PER SHIRT!

(plus \$1 per shirt postage & handling)

I Enclose \$ _____
(Check or M.O.)

Fla. Res. Add 4% Sales Tax

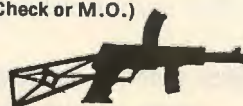

Gateway Sporting Goods
713 N.E. 119th St.
Miami, Fla. 33161

Special Forces Green S ___ M ___ L ___ XL ___

Police Blue S ___ M ___ L ___ XL ___

Name _____

Address _____

City _____ State _____ Zip _____

BUMPERSTICKERS!

100% VINYL Bumperstickers, 3"x12", with black ink on bright yellow Vinyl stock. HOW TO ORDER: Min. order, \$2.00. Prices are postpaid, via 3rd Class. For 1st Class, add 5¢ EACH Bumpersticker. Mix or sort as you wish. Check with order; sorry, no c.o.d.'s. Satisfaction guaranteed or money back

AS LOW AS
29¢
EACH

No. 1 PROTECT YOUR RIGHT TO PROTECT YOUR HOME	No. 6 GOD CREATED MEN BUT WINCHESTER MADE THEM EQUAL
No. 2 IF YOU TAKE MY GUN I TAKE MY FREEDOM DON'T TRY IT!	No. 7 WHEN GUNS ARE OUTLAWED I'LL BE AN OUTLAW
No. 3 PUNISH CRIMINALS NOT LAW ABIDING GUN OWNERS	No. 8 GOD GUNS, GITS LET'S FIGHT TO KEEP ALL 3
No. 4 CRIME CONTROL NOT GUN CONTROL!	No. 9 PROTECT YOUR RIGHT TO BEAR ARMS
No. 5 I'LL GIVE UP MY GUN WHEN THEY PAY IT FROM MY COLD DEAD FINGERS	No. 10 CRIME WOULDN'T PAY IF THE GOVERNMENT RAN IT
PRICES	
1 to 10	39¢ ea
11 to 50	34¢ ea
51 to 200	31¢ ea
over 200	29¢ ea
No. 11 FREE MEN OWN GUNS SLAVES DON'T	No. 12 THE WEST WASN'T WON WITH A REGISTERED GUN

Any Wording You Want on a Bumpersticker!

Yup, we'll print ANY message you want on a 3"x12" Day Glo Bumpersticker. Two lines of copy with up to 14 letters on one line, and up to 20 letters on the other line. \$2.95 for first one. Extras (with same message) 60¢ each. Post paid to you via FIRST CLASS MAIL.

Headline Printers

P.O. Box 444-M
Anacortes, WA 98221
PH. (206) 293-5966

ELECTRONIC SURVEILLANCE

... has been prepared for public sale by the original authors.

This new publication, THE SCIENCE OF ELECTRONIC SURVEILLANCE, is based on a special staff study recently completed for the National Wiretap Commission. It openly describes all known electronic privacy invasion techniques and security countermeasures.

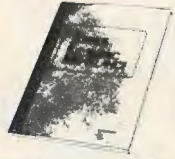

Topics Include:

- Telephone wiretapping and bugging, special purpose surveillance microphones, lasers and light beam devices, miniature radio transmitters and recorders, radio flooding and passive reflectors.
- Audio countermeasures and de-bugging services, radio transmitter detection meters, magnetic and electronic bug jamming systems, telephone de-bugging and analysis and secure rooms.
- Eavesdropping in computers, typewriters and duplicating machines

THE SCIENCE OF ELECTRONIC SURVEILLANCE will provide law enforcement officials, industrial security directors, training academies and professional consultants with the detailed information necessary to plan effective electronic security programs — a necessary addition to the complete security library.

\$18.95

We'll ship your order immediately. Prepaid.

INTELATEX

1201 Bethlehem Pike
Flourtown, PA 19031
215-836-7575

would make a "black" landing on the south coast of Cuba: The Boston Whaler would be hidden in a narrow cove near the home of a close friend of the older Cuban. The two young men would proceed inland and attempt to resume "ordinary" lives at the homes of parents or friends. Meanwhile, the elderly fisherman would work the local fishing boats with his old partner and act as a standby in case of emergency. The information which the team hoped to collect would be passed back to the station by means of a radio transmitter which they would set up in a clandestine location.

The case officer said that the three volunteers had been smuggled out of Cuba by the CIA a month earlier specifically to train for this mission. Their infiltration was scheduled for the latter part of May, so there was very little time for small-boat training; communications and tradecraft instruction had already taken up most of their time.

When the case officer left and we joined the team, Perry was pleased to discover that one of the younger men spoke English. Through him, Perry asked about their previous experience with boats: only the elderly fisherman had spent any time at sea. However, one of the other men was an automobile mechanic, and his general knowledge of machines would be useful. The third man had been a stonemason.

I stayed with Perry and the infiltration team for the next five days, observing every phase of their training. Perry covered the construction and characteristics of the Boston Whaler, the me-

chanical operation of a standard 20-horsepower Johnson outboard engine, and methods of concealing and camouflaging. No time was wasted on extended lunch periods and afternoon siestas, as was the case at the training bases on Elliott Key and Key Largo. The team members asked few questions, but they were attentive and made every effort to absorb what Perry said. Nevertheless, it seemed that the younger men were already planning to depend on the wisdom and experience of the fisherman during the mission.

It was a 60-mile drive to the Flamingo development, which consisted of a large government-operated marina, motel, service station and power plant, and a few official buildings. When we arrived each day we quickly loaded our gear—the military items concealed in burlap bags—onto a Whaler and set off on the hour-long trip to the secluded training area just west of Cape Sable. It was undoubtedly one of the loneliest and most disagreeable areas in the U.S., but it was also one of the most secure. There was no worry about intruders stumbling onto the training, and, aside from a boat or two well off shore, we could easily forget the rest of civilization.

By midmorning the heat and the mosquitoes were nearly unbearable, even when we were anchored off shore. The only respite came while we were moving, and then only when we were well away from the desolate, swampy coastline. We spent most of each day in the small boat, allowing the team members to gain proficiency in maneuvering it,

T-SHIRTS

\$6.95each

- Fast Delivery -

MILITARY GRAPHICS

P.O. Box 9671-K
Baltimore, Md. 21237

SWEATSHIRTS

\$8.95each

- Brand Name Shirts Used -

- Choice of Colors -

Unit Shirts In Stock

 a	 b	 c	 d	 e	 f	 g	 h	
 i	101st.(ABN) - J	82nd.(ABN) - K	U.S.N. Seal - Q	French Commando - R	U.S.A.F. Pararescue - S	British S.A.S. - T	L.R.D.G. - U	SS Runes - V

(ABN) Master - W
CUSTOM WORK FOR GROUPS AVAILABLE
send for details

For Larger Selection, Including (9) British Regiments Send \$1.00
For Our Catalog (FREE WITH PURCHASE)

(When ordering, please specify shirt type, color, size, and insignia desired)

SHIRT COLORS - White, Gold, Blue, or Green in Small, Med, Large, X-Large

ALSO AVAILABLE:

8x11, Hand Engraved, Scrolled Borders, Place for name, rank, and dates served

U.S. SPECIAL FORCES

U.S.N. SEAL

AWARD CERTIFICATES

U.S.M.C. FORCE RECON

U.S.A. MASTER JUMP(Qual.)

\$ 8.00EACH

operating the motor, navigating, and holding a course by dead reckoning. The fisherman was quite at home, and soon the other team members gained confidence.

Perry gradually made the training exercises more challenging. We took practice runs through the maze of channels in Whitewater Bay, and all the Cubans learned to run the Whaler and operate the engine in shallow water. They experienced several real engine stoppages, and Perry simulated three others in which the Cubans had to diagnose the problem and make the necessary repairs. The young mechanic proved his worth in these situations. Perry also showed the men various techniques for concealing and camouflaging the unsinkable Whaler in the vegetation.

The week was concluded with night navigation under full blackout conditions. This exercise gave the Cubans an idea of what they would have to contend with in getting ashore in Cuba and also gave them practice in the use of the RDF. Using a fast 20-foot runabout, Perry and I towed the Whaler, with the team aboard, to a point approximately seven miles off the southern tip of Cape Sable. This was roughly the distance that the team would have to navigate in their actual mission into Cuba. After we had released the team, we moved to a spot several hundred yards off shore to observe them as they carefully made their way to the beach. I could see that Perry

was pleased with their progress, and I was impressed with their boat handling and navigation, but I was disappointed by their disregard for stealth and personal security when they finally got on the beach. Anyone within several hundred yards could have heard them, and an enemy patrol certainly would have picked them up.

The day after the small-boat training was completed, the infiltration team's case officer came to the safehouse for his men. He was in a hurry, so Perry gave him only a brief recapitulation of the team's performance. The men would be on their way to Cuba before a written report could be completed, and then it would be of little value. Perry and I wished the exiles good luck, and they jumped into the officer's car and were gone. Perry and I, physically and emotionally fatigued, drove silently back to Miami.

My overall impression of the CIA training program was one of distinct disappointment. But, was I being unfairly critical? I knew that maintaining secrecy was a major hindrance to training—the inquisitive public, the probing news media, the constant operational pressure were factors that had to be considered. And I could not deny that many aspects of what I had seen had been quite impressive.

The magnitude of the operation—the boats, the safehouses, the commando groups, and the administration and

NUNCHAKU

Powerful, but Compact Weapon from the East!

Many times more effective than knives or clubs, even against multiple attacks. Whipping motion afforded by flexible connection between handles yields many times the speed and power of just a straight stick.

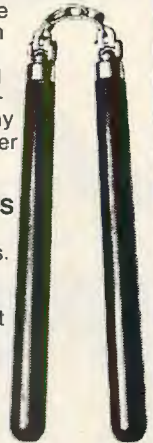

FREE MARTIAL ARTS CATALOG

Over 18 nunchaku models. Many feature our own patented swivel-chain which provides smoothest operation, maximum strength & the least wear. Made of wood, aluminum or rubber. Round or Octagon shaped. Swivel-chain or Nylon cord connection.

- WEAPONS
- BOOKS
- THROWING KNIVES
- UNIFORMS
- TRAINING EQUIPMENT
- KARATE
- KUNG-FU, etc.

SEND YOUR ORDER TO

DOLAN'S SPORTS

620 FAIRVIEW AVE., DEPT. SF, NEPTUNE, N.J. 07753

Phone 201-922-3382

DEALERS WRITE ON LETTERHEAD

★ NEW ★ NEW ★ NEW ★ NEW ★ NEW ★ NEW ★ NEW ★

Join The Professionals

FOR LIFE!

\$100

FOR A LIFETIME SUBSCRIPTION TO

Soldier of Fortune

The Journal of Professional Adventurers

Enclosed is \$100 for a LIFETIME SUBSCRIPTION to:

SOLDIER OF FORTUNE
PO Box 693
Boulder, Colorado 80306

[Print]

Name _____

Address _____

City _____ State _____ Zip _____

ALLOW SIX WEEKS FOR DELIVERY OF FIRST ISSUE

★ NEW ★ NEW ★ NEW ★ NEW ★ NEW ★ NEW ★ NEW ★

VIGILANTE MAGAZINE

SUBSCRIBE TODAY!



1 Year (4 issues) only \$8.00
(U.S., Canada, Mexico)

A NEW MAGAZINE OF PERSONAL SECURITY WITH THE MOTTO:

— Better tried by 12 than carried by six —

Kenneth Turan, *The Washington Post* — "The first issue, as advertised, is chock full of practical, steel-spined, hard-hitting articles on the real-life side of personal and physical security."

Roger Simon, *Chicago Sun-Times* — "A new national magazine with step-by-step instructions for gouging the eyes, beating the brains and otherwise wiping out anyone foolish enough to mess around with you."

Let's make the streets unsafe for the criminals!

Send to: VIGILANTE MAGAZINE
P.O. BOX 31085 — PHOENIX, AZ 85046

I have enclosed \$8.00. Send subscription to:

Name _____

Address _____

City _____ State _____ Zip _____

— SPECIAL HANDLING —

Airmail add - \$5.00

Foreign (Air) add - \$8.00

CARCANO RIFLES No F.F.L. Req
Pre 1898 - Long Rifle
6.5 Italian

1 Gun \$34.95
Good to Excellent.

original as
issued condition.

2 to 5 Guns \$32.50/Ea

6 to 10 Guns - \$27.50/Ea

\$2.00 postage per gun
or we will ship postage collect.

no C.O.D.

NUMRICH ARMS CORPORATION
WEST HURLEY, NEW YORK 12491 • BOX S.F.
PHONE 914-679-2417

**NEW GUN PARTS
CATALOG
NO. 6**

FROM
THE
WORLD'S
LARGEST
SUPPLIER

Our new bicentennial catalog, NO. 6—bigger & better than ever. Over 100 million gun parts in inventory, both military & commercial. Write for yours today.

\$3.00—Foreign

PRICE, \$2.00.



logistics involved in maintaining the program. It was an ingenious work of organization and control, considering the ever-present need for secrecy. Despite the protective idiosyncrasies of Turk and Bob and some of the other CIA people, it was obvious they were willing to withstand physical hardships. Most of all, I was impressed by the Cuban exiles, who were the real "soldiers" in the CIA's paramilitary army. With very limited training and only essential gear and basic weapons, they had courageously volunteered to return to their homeland to fight against a sophisticated and superior Cuban-Soviet force.

I spent the following weekend trying to consolidate the observations I'd made in the last three weeks. In general, the average Cuban exile lacked the background, self-discipline, physical fitness, and emotional stability required. However, he was determined and adaptable, enthusiastic, and brave to the point of foolhardiness. He had deep personal pride and was very much aware of his image as an anti-Castro freedom fighter.

But apparently, there was little impetus from higher levels at the station to train the Cubans, and the training branch was called only at the request of a team officer. There was no training schedule or program of mandatory subjects, except for tradecraft.



The "Woolly Pulley"!

100% PURE VIRGIN WOOL Imported from England!

A rugged, heavy rib knit, super warm **OUTDOOR SWEATER**. Ideal for Backpacking, Hunting, Boating, Skiing, & all cool weather activities.

Long used by the British SAS Commandos and Parachute Regiment as a more serviceable jacket replacement. Matching cotton/polyester Twill shoulder & elbow patches reduce piling, snagging, and abrasion wear. Crew neck design for added comfort. Extra long body prevents "ride-up". Home washable.

Sizes 36 to 46. Women's S, M, L. Choice of Olive Green, Blue-Grey or Royal Navy Blue. Money back guarantee. M.C., B.A.C., Checks, M.O., and C.O.D.

Phone orders 404-943-9336 (24 hr. service)

ONLY

BRIGADE QUARTERMASTERS, LTD.

\$34.95

P.O. Box 108-L
Powder Springs, Ga. 30073

PLUS \$1.50 POSTAGE
GA. RES. ADD. TAX.

ORDER TODAY! Prompt Delivery.

Personal Defense

by Chris McLoughlin and Blackie Collins

160 pages with 228 photographs covering firearms, edged weapons, dogs, chemical devices, martial arts, rape, and much more will give you the edge against any attacker. One of the most important sections deals with building your mental preparedness. This book will make you aware of what can happen to you and tell you how to deal with each situation in an effective and professional manner. Buy a copy of this book for yourself and anyone whose safety is your concern. It could save your lives. It will definitely make you feel more secure.

To order send **\$7.95** to:

Defense

P. O. Box 18595

Atlanta, Georgia 30326

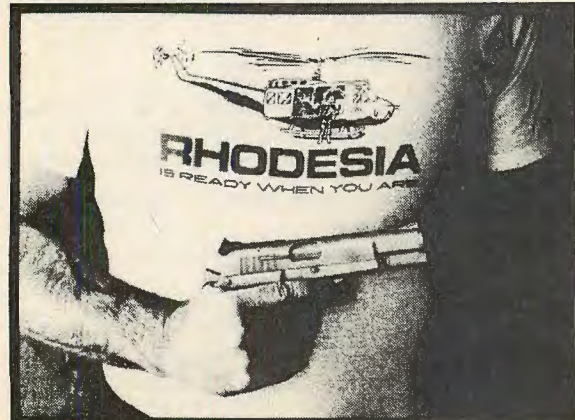

New!
**ORDER
TODAY!**

\$5.95 each

Please add 75 cents for each item
for shipping and handling.

Size

M

L

PARAMILITARY MARKETING &
WILDERNESS OUTFITTERS
P.O. Box 662
Rosemont, IL 60018

It seemed that exile training was considered the least important of all activities, but it should have been second only to the actual operations.

The training branch had never been asked to give instruction to either of the commando groups, and the commandos enjoyed privileged status among the exile volunteers.

The deeper I got into the training setup, the more disturbed I became. The low priority given to training, the apparent lack of cooperation shown by the case officers, and the absence of sound practices in commando training reflected a poor appreciation for the dangers the exiles had to face. Fundamental principles of training and methods of teaching were being ignored in many cases, in the instruction that was given.

If I were to make a significant contribution at the Station, I saw my first task as doing what I could to upgrade the exile

training program. I knew I would have to overcome monumental bureaucratic inertia, but I was determined. As a professional soldier, but unable to do the fighting, I was compelled to give the Cuban exiles the best paramilitary tools my background and experience might provide. This became my first undertaking in my mission with the CIA.

(Part 2 of this series will deal with the organization of the new Cuban exile training program at JM WAVE.)

1. Outside agents were American or Cuban CIA employees who were not cleared for entry into the undercover headquarters. These employees were either too "hot" because of exposure to exiles or did not have proper security clearance. Contact with these persons was always made clandestinely on the outside, using individually assigned operational cover; in my case, the Paragon Air Service cover.

2. Tradecraft is the term used to describe the basic techniques and procedures used by CIA secret agents. The agency has a manual much like a military field manual which establishes guidelines and sets forth fundamental techniques for a variety of clandestine activities.

MY RIGHT



State your right to keep and bear arms with this richly embroidered 4 1/2" x 3" emblem. 6 handsome colors on black background. Postpaid \$3.75.

FREE DECAL included.

THE AMERICAN

P.O. Box 6696 Chicago, Ill. 60680

Secrets of Modern Knife Fighting

By
David E. Steele

David Steele's long awaited book on knife fighting leaves no room for disappointment. Steele analyzes every detail of employing the knife in combat, including underwater knife fighting, and utilizes step-by-step "how to" photos. In addition he describes, compares and evaluates fighting techniques of the middle ages and the techniques of Jim Bowie, John Styers, and Rex Applegate. Steele also evaluates a wide assortment of knives from all over the world.

CHAPTERS INCLUDE:

- The Fighting Stiletto
- Sheath Styles & Sharpening Stones
- Improvised Weapons
- Knife Fighting Past & Present
- AND MUCH MORE!

**145 PAGES/215 PHOTOGRAPHS
HARDCOVER - \$15.95
SOFTCOVER - \$ 9.95**

(Colo. Res. Add 3% Sales Tax)

ABOUT THE AUTHOR

David Steele holds a master's degree in Police Science. He served as rifle and pistol instructor for the National Rifle Assoc., and as supervisor for the Police Weapons Center Project at the International Assoc. of Chiefs of Police. Steele, an accomplished fencer, as written several books on small arms.

ORDER TODAY

from
**PHOENIX ASSOCIATES
P.O. BOX 369 - DEPT. SF
BOULDER, COLORADO 80306**



Static Line

Your Airborne "Lifeline"

Box 87518, College Park, Ga. 30337

Editor: Don Lassen

Phone 404-996-4420

The AIRBORNE STATIC LINE is a monthly publication for, by and about Paratroopers and men with Airborne hearts.

This publication is dedicated to the perpetuation of the Airborne ideals of brotherhood, fellowship and camaraderie established in the warfare, strife and duress of World War II.

The Airborne ideals are synonymous with the ideals and objectives of the founding fathers in 1776.

The AIRBORNE STATIC LINE is a publication for ALL the Airborne. PUBLISHED 12 TIMES PER YEAR, DUES FOR THIS PUBLICATION ARE \$12 PER YEAR. YOUR LETTERS, SUGGESTIONS, COMMENTS AND CRITICISMS ARE SOLICITED.

HOOK UP MY STATIC LINE—HERE'S MY \$12.

Name

Address

..... Zip

Unit Phone No.

Date

AFRICA IS BURNING

(continued from page 27)

"troopie," is prepared to settle for much more protracted engagements. In some cases artillery and rocket bombardments, as Maputo Radio has told us, have on occasion, lasted several days.

For Africa, this grim specter of hostilities almost throughout East, Central and certain Western parts of the continent presents a foreboding picture for the future.

Clearly, the influence of the major powers remains, with Moscow taking the lead in sowing insurrection, dissension, and revolution as and where the opportunity presents itself.

The tragedy of the issues at stake is not some clear-cut ideological victory, either to the East or the West. Rather it is the amount of innocent blood that must flow while the world's leaders plan the destinies of nations with which they have never had anything in common, political, socially, or culturally.

Such is the nature of hostilities in Africa in 1977.



STATEMENT OF OWNERSHIP, MANAGEMENT AND CIRCULATION (ACT OF OCTOBER 23, 1962: SECTION 4369, TITLE 39, UNITED STATES CODE)

1. SOLDIER OF FORTUNE MAGAZINE
2. SEPTEMBER 30, 1977
3. BI-MONTHLY
4. 1728 1/2 28th Street, Boulder, Colorado 80302
5. Business office: 1728 1/2 28th Street, Boulder, Colorado 80302
6. The names and addresses of the Publisher, Editor and Managing Editor are: Publisher, Robert K. Brown, P.O. Box 693, Boulder, CO 80306; Editor, Robert K. Brown, P.O. Box 693, Boulder, CO 80306; and Business Manager, Mary Jane Webb, P.O. Box 693, Boulder, CO 80306.
7. That the owners are: Omega Group, Ltd. (corporation), 1728 1/2 28th Street, Boulder, Colorado 80302.
8. That the known bondholders, mortgagees, and other security holders owning or holding 1 percent or more of the total amount of bonds, mortgages and other securities are: Robert K. Brown, President, P.O. Box 693, Boulder, CO 80206; and Donald L. McLean, P.O. Drawer N-2, Wickenburg, AZ 85358.
9. N/A
- 10.

	Average No. Copies each issue during Preceding 12 Months	Single Issue Nearest to Filing Date
A. TOTAL NO. COPIES PRINTED (NET PRESS RUN)	97,000	115,000
B. PAID CIRCULATION		
1. Sales through dealers and carriers, street vendors and counter sales	27,335	54,725
2. Mail Subscriptions	9,665	10,275
C. TOTAL PAID CIRCULATION	37,000	65,000
D. FREE DISTRIBUTION BY MAIL, CARRIER OR OTHER MEANS		
SAMPLES, COMPLIMENTARY AND OTHER FREE COPIES	180	160
E. TOTAL DISTRIBUTION	40,140	65,160
1. Office use, left over, unaccounted, spoiled after printing	2,200	49,840
2. Returns from news agents	942	340
G. TOTAL	97,000	115,000

I CERTIFY THAT THE STATEMENTS MADE BY ME ABOVE ARE CORRECT AND COMPLETE.

ROBERT K. BROWN, PUBLISHER

FLAK

(continued from page 12)

disability these 33 years from former Naval and Coast Guard service. When the social and economic roof caves in, I am prepared to die on my own doorstep, as I may die in a dictatorship, but I'll be damned if I'll ever live in one!

Respectfully,

DeMart C. Besly
Box 21
Darby, Montana 59829



ELECTRONIC SECURITY AND COUNTERMEASURES EQUIPMENT



Mark II Voice Analyzer

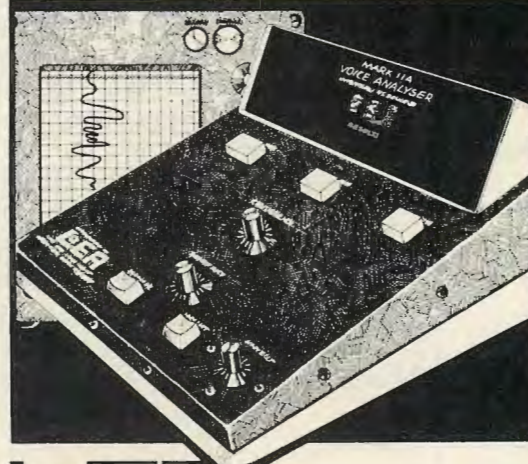

LAW ENFORCEMENT ASSOCIATES, INC.
88 Holmes St. Belleville, N.J., U.S.A. 07109
(201) 751-0001 Cable: LEA

Please write for our complete catalog.
Enclose \$3.00 U.S., \$5.00 overseas for postage. Refundable first order.

S.O.F. SPECIAL
3 x 9, 32 m m.



WATERPROOF
FOGPROOF

\$39.95



BROWN
TELESCOPICS
558 MILLER
ELGIN, IL. 60120

The MARK II operates directly from a microphone or from any tape recorder providing an instantaneous digital display of stress reactions of the speaker.

Ten years of intensive research & development has resulted in a revolutionary new electronic digital device providing an instantaneous numeric value of stress in speech.

Applications include pre-employment screening, police and security investigations, insurance adjustment, internal loss prevention.

L.E.A. specializes in developing high quality electronic aids for specialized applications.

Our scientific investigatory and countermeasure equipment are currently being used throughout the world by large and small companies and police departments who require guaranteed performance.



ADDITIONAL PRODUCTS DISTRIBUTED

- Attache Case Recorder
- Body Armour
- Body Transmitter
- Countermeasures Equipment
- Identification Equipment
- Investigative Devices
- Mark II Voice Analyzer
- Miniature Recorders
- Night Vision Systems
- Parabolic Microphone
- Scramblers
- Telephone Recorders
- Vehicle Followers
- Weapons Detectors

LOOKING FOR QUALITY?



• Flash Suppressor Reg. or set back **\$1595**

• 16" Barrel w/barrel extension and installation kit. **\$6995**

• Gas tube—short type **\$945**

★ XM177E2 ★

• "Colt" Hand guard w/heat shields and round end cap. **\$2795**

• Cone type Slip ring XM177E2 **\$795**

• Light weight 30 round magazine **\$995**

4 to 6 week delivery 25% Deposit for C. O. D.

California resident add 6% tax Dealer/Police inquiries invited.

• Telescoping Buttstock assembly, Reduces length **\$7995**

• MG OD Green Grey Black Parkerized type finish. **\$650**

Make Check payable to:

LOCK STOCK-N-BARREL

P.O. Box 3102, Granada Hills, Ca. 91344

★ SPECIAL ★ ★ LIMITED OFFER ★

Individually Crafted And Numbered Soldier Of Fortune Belt Buckles In Solid Bronze For Only \$14.95.



These buckles are made by Lost Wax Products. Each buckle is made in wax and the wax is placed in a mold, then melted out of the mold and the molten bronze is poured in, after which each bronze buckle is individually polished and numbered. The Buckles were designed by W. R. Vielehr, and carved by E. K. Field, both of whom are nationally exhibiting sculptors.

ORDER YOUR COLLECTOR'S ITEM TODAY

Send Check or Money Order to:
PHOENIX ASSOCIATES
PO BOX 693 DEPT SF
BOULDER, COLORADO 80306

Improve Your Shooting Skills . . .



Join PMA - Learn From Pros!

Get ready for a different kind of action . . . when you read POLICE MARKSMAN Magazine, the official publication of the Police Marksman Association. That's because PMA is America's first organization dedicated solely to helping law officers improve their skills both for competitive shooting and as a training supplement!

National Champion Combat Winners and firearms training experts combine their talents to teach you techniques and methods in every page of POLICE MARKSMAN Magazine. It's a unique magazine written by law officers for a special breed of shooters.

OTHER FULL-FLEDGED PMA MEMBER BENEFITS

- Membership Card—Personalized Card identifying you as a Full-Fledged PMA Member.
- PMA Emblem—You'll receive a smart embroidered patch to wear proudly on your cap or jacket.
- PMA Awards—You become eligible for PMA National Competitive Shooter Awards.
- Postal Matches—You can participate in Special Postal Matches conducted by PMA.
- Buying Service—To help you find hard to locate equipment as well as discount buying opportunities.
- Shooter's Info Service—Free material on location and dates of matches including travel, hotel data.

"PMA—A good asset for all officers who are interested in improving their shooting skills and their chances of survival."

That's just one sample of the hundreds of unsolicited comments we get from already satisfied PMA members. So don't delay. Fill in the application below and mail today with your dues. Start enjoying your PMA benefits now!

POLICE MARKSMAN ASSOCIATION

200 South Hull Street Montgomery, Alabama 36104

Yes! Enroll me as a member of PMA as indicated below. If I am not completely satisfied, I will notify you and you will refund my dues.

Full-Fledged Member: 1 yr.—\$15—Eligible for all PMA Benefits (open only for recognized law enforcement personnel.)

Associate Member: 1 yr.—\$10 (THE POLICE MARKSMAN Magazine only) Open to interested shooters.

Check one Dues enclosed; Bill me

Charge my:

MC# _____ Exp. date _____

BAC# _____ Exp. date _____

Bank on which account is drawn _____

NAME _____

Title/Position _____

Street _____

City _____ State _____ Zip _____

RUVEL & COMPANY

U.S. GOVERNMENT SURPLUS

New G.I. M65 Army Field Jackets, S.M.L.XL - \$35.00 ea.
New M65 Liners - \$14.95 ea.

48" Paratroop Dropcase - \$10.00/37" Carbine Dropcase - \$6.75

New G.I. Pistol Belts - \$7.50

G.I. 2 1/2" Gun-Cleaning Patches - 200/\$1.00

Sealed Case - 10,000/\$45.00

Carbine 30-rd Mags - \$3.80/Chrome - \$5.50

Two 15-rd Mags & Pouch - \$2.15/15-rd Mags - \$1.00

Chrome 15-rd Mags - \$3.00

4-rd Hunting Mags - \$2.25

M1 Carbine Stock - \$6.50/Handguard - \$3.50

U.S. Carbine Bayonet Arsenal-Reconditioned

Bakelite Grips W/Sheath - \$22.50

Sling & Oiler - \$2.00

Carbine Frontband Assembly W/Bayonet Lug - \$5.00

M5 Garand Bayonet W/Sheath - \$10.50

Garand M10 Cleaning-Rod Set - \$6.50

Garand Stocks - \$10.00/Handguards - \$4.00 ea.

1917 Enfield Stocks - \$9.50/Handguards \$5.00 pr.

New Springfield Bolts complete - \$5.50

Low-Scope Bent Bolt Bodies - \$4.75

Bent Bolt complete - \$9.50

M14 Stocks - \$12.50

M14 20-rd mags - \$4.00

M14 Ammo Pouch - \$2.00

M14 Bayonet W/Sheath - \$12.50

New Web Slings for Garand, Springfield - \$1.65

Garand Clips - 10/\$1.00

New G.I. 10 Pocket Cartridge Belts - \$8.50

New U.S. Army 45 Auto Pistol Hip Holster - \$7.95

New G.I. M7 45 Shoulder Holster - \$14.95

GVT Type 45 Shoulder Holster - \$6.25

M1911 45 Auto Mags - \$4.95

AR15 20-rd Mags - \$4.00/AR15 Bayonets

W/Sheath - \$14.75

AR15 Nylon 20-rd Ammo Pouch - \$4.50/30-rd

Pouch - \$6.00

New G.I. AR15 Bipod - \$12.95/Bipod Case - \$2.25

Genuine U.S. Machette, 18" Long - \$6.95

G.I. Machette Scabbards WWII Issue O.D.

Canvas - \$3.25

Latest Issue G.I. Nylon/Plastic Material

W/Steel Top - \$6.25

COMPLETE LISTINGS FOUND IN OUR CATALOG. SEND \$1.00 (FREE WITH \$5.00 ORDER). ALL ITEMS VERY GOOD UNLESS OTHERWISE STATED. PRICES PLUS POSTAGE. ILLINOIS RESIDENTS 5% TAX. RUVEL S.2. 3037 N. CLARK, CHICAGO, IL 60657.

PHONE TAPPED?

EAVESDROPPER STOPPER



SILENTLY INDICATES WHETHER SOMEONE ELSE IS LISTENING!
\$29.95

Indicates presence of tapping devices. . . if line is busy. . . if extension is listening.

ELIMINATE POSSIBILITY OF TAPS OR UNAUTHORIZED LISTENERS-IN ON PHONE

- Makes your phone secure
- Prevents interruptions and arguments
- Works whether call is being made or received
- Use it at any location
- No interference with normal operation
- Works with party lines

Adjustable for ALL telephone installations

DEALER INQUIRIES INVITED

MONEY BACK GUARANTEE

FREE telephone accessories and detection devices catalog with purchase. Send check/money order (add \$2.00 for postage and handling, plus local sales tax)

SILENCE IS GOLDEN

Dept. SF P.O. Box 112

Nyack, N.Y. 10960



Crown Surplus Stores Ltd

1005 - 11th Street S.E.
Calgary, Alberta
Canada T2G 3E9
**CAMOUFLAGE
SUITS**

GERMAN	\$29.95
ITALIAN (light)	\$14.95
ITALIAN (heavy)	\$29.95
CANADIAN ARMY BATTLE DRESS: TUNIC & TROUSERS KOREAN	
WAR ISSUE	\$ 9.95
CURRENT ISSUE CANADIAN ARMY: WORK DRESS	\$ 9.95
DRESS GREENS	\$ 9.95

GOOD CONDITION

USED NATO COMBAT JACKET AND TROUSERS—SET	\$12.95
BRITISH ARMY TANK CREW SUITS— GOOD CONDITION	\$19.95
CANADIAN ARMY COMBAT BOOTS— GOOD CONDITION	\$ 9.95

WWII RAF ESCAPE MAPS OF NORTH AFRICA

24x26 WITH TRANSLATION SHEET OF
PRONOUNCIATION OF HEBREW,
YIDDISH, ARABIC, ENGLISH AND
GERMAN - COLOR - SUITABLE FOR
FRAMING \$11.95

Western Canada's
Most Authentic Military
Surplus Store



SILENT DEATH

(continued from page 41)

Apparently General Ewell was pleased with the sniper program, as he noted in "Impressions of a Division Commander in Vietnam,"

The most effective single program we had was the sniper program. This took a whole year to get off the ground from scratch, but we ended up with 80 snipers who would kill (or capture) from 200 to 300 enemy per month. Not only did we get this direct return, but they also encouraged the other men to shoot well. Snipers, like everything else, are highly sensitive to tactics and techniques, so one has to handle them well. The flat, open delta terrain was ideal for snipers. Other divisions are now trying snipers in other areas, so we shall see how they work on a broader basis. Snipers had been tried before in the theatre with tepid results, but we insisted that the program be exactly right, demanded results and got them.

During his tour of duty, Waldron became one of the most highly decorated soldiers of the Vietnam conflict. He was awarded three Distinguished Service Crosses, two Silver Stars, four Bronze Stars, three Air Medals and two Purple Hearts.

In light of all the controversy surrounding the accuracy of "body counts" reported by both the South Vietnamese and

American units, it is worth noting that in the course of calculating sniper kills, no VC or North Vietnamese was counted as a "kill" unless an American trooper, either the sniper or a member of the support unit, actually was able to physically place his foot on the body.

Wars may come and wars may go, but the valiant U.S. Army sniper personnel again proved the value of a man and a rifle. Let's hope the Army doesn't forget this lesson as it has others in the past.



SURVIVAL-HUNTING BLOW-GUN, 125 steel darts. Silent, powerful, accurate. Hits like a bullet. 200 Ft. range. Rugged .38 cal. precision aluminum, carry case, instructions. 4 1/2" model \$6.98! 5 1/2" \$7.98! Magnum 6 1/2" \$9.98! Extra darts \$2.50/100! \$4.50/200! \$11/500! Buy 2 guns get 800 darts, sling, quiver, matches, camouflage, targets FREE! 3 get same - 1400, cleaning rod, muzzle guard; 4 same, 2000, 20" mini-blowgun! 5 same, 2000, free 7th gun! Add \$1.50 postage each gun. **HOUSE OF WEAPONS, INC.** Box 794-A Provo, Utah 84601

MACHINEGUNS - AUTOMATIC WEAPONS

& Related Para Military Ordnance

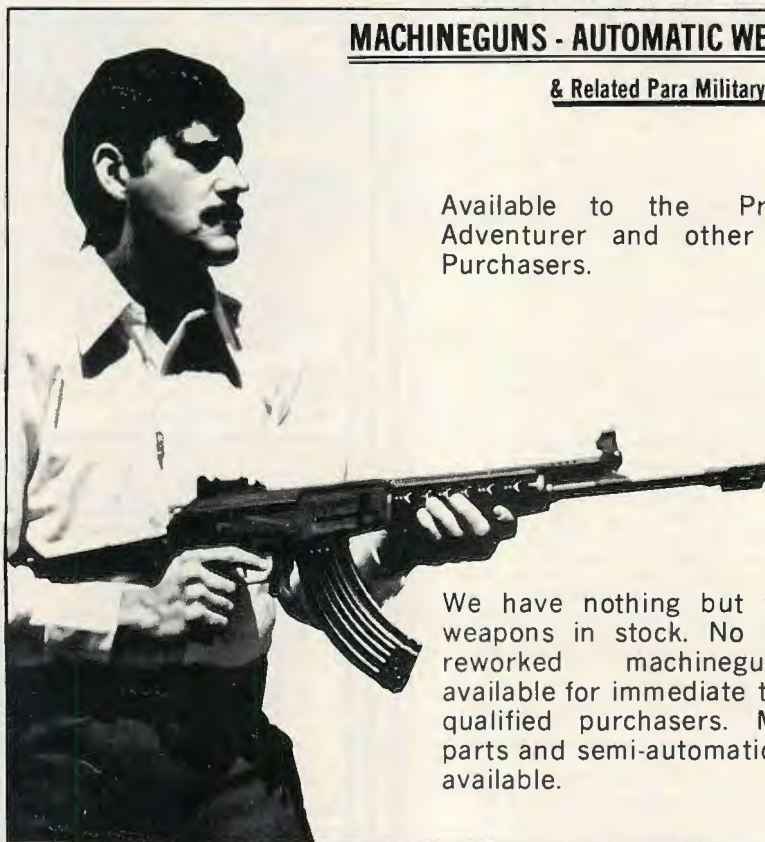

Available to the Professional Adventurer and other Qualified Purchasers.

We have nothing but the finest weapons in stock. No reworks or reworked machineguns. All available for immediate transfer to qualified purchasers. Many MG parts and semi-automatic weapons available.

Write for free listing.

R.J. PERRY ASSOCIATES, INC. - BOX 151 - PARK RIDGE, IL - 60068
(312) 696-0930 (24 hours)

BULLETIN BOARD

(continued from page 19)

NEW "PROFESSIONALS" WATERING HOLE . . .

Professionals arriving in South Africa should check out a new watering hole called "Deaf Pete's Deep," a bar in the Johannesburg Hotel near the center of the city. Is frequented by U.S. volunteers on furlough from Rhodesia, Rhodesian and South African professionals and numerous Portuguese veterans engaged in ops in various theaters of activities in Southern Africa. Just ask the Portuguese barman behind the counter what's happening.

RHODESIAN BORDER PATROL WELFARE FUND . . .

New address for Rhodesian Border Patrol Welfare Fund is c/o E.H. Passaportis, P.O. Box EH 86, Emerald Hill, Salisbury, Rhodesia. All contributions should be sent in form of cash or traveler's checks due to the U.N. embargo. Send what you can. Every little bit helps.

U.S. ARMY CAN'T SHOOT . . .

July issue of Army magazine carries an article by a distinguished Army marksman and Olympic medalist who contends the U.S. soldier is a poor shot and urges emphasis on marksmanship to correct a dangerous flaw in our state of readiness.

STAFF NOTES . . .

SOF Aviation Editors have been active this summer. Walt Darran, ex-Navy and Air America pilot in S.E. Asia, flew a Stearman PT-17, dropping water and retardant on forest fires; Rocky Kemp played crop duster in Nebraska (not quite as exciting as Mozambique); Dana Drenkowski shot in the South African National Combat Handgun Championships.

Drenkowski and Associate Editor Tom MacGregor, accompanied by ex-SOG vet Jim Bolen, are in Southern Africa, evaluating several new side arms and checking out the terrorist war in Rhodesia. Their reports will be carried in the next issue.

Mike Echanis has been appointed Contributing Editor, Martial Arts.

GUERRILLA WAR IN S.E. ASIA . . .

Anti-communist guerrilla forces are fighting the red regimes of Laos, Cambodia and South Vietnam. Though commanding the allegiance of a large portion of the populace, they have limited weapons and ammo—and, of course, no support from the West. Without external sources of support their cause is hopeless.

SHOOT LOOTERS . . .

President Carter and Andrew Young cried that "hunger" was the motivating force behind the looting during 13-14 July blackout in New York. However, Brooklyn DA disagrees. He said of the 176

persons indicted 48% were regularly employed, 41% were in an anti-poverty or educational program, and fewer than 10% were on welfare.

It's obvious, contrary to the blatherings of Young and Carter, they weren't hungry—they were thieves.

The time-honored method of dealing with looters would have prevented this debacle — shoot them.



THE AEROMAG BLOWGUN



The AEROMAG BLOWGUN is all aluminum, darts have machined aluminum air-cones with piano wire darts—NO plastic or rubber used on the blowgun or darts, only machined parts. Blowgun and six darts—\$14.95, additional darts \$2.95 per set of six. Postpaid in U.S.A.

NOT A TOY, FOR ADULT USE ONLY

If you demand the best, the AEROMAG BLOWGUN was made for you. Japanese swords & daggers wanted, we pay top cash.

AEROSPACE CONE

P.O. Box 142, Decatur, Georgia 30031

WALLET • HOLSTER for Hi-Standard Derringer

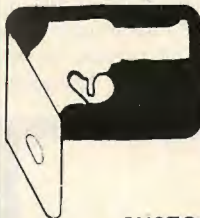

Looks Like Regular
Wallet on Outside:
Packs a 2-Shot
Punch Inside!

ONLY \$13.50
POSTPAID

CUSTOM-MADE

For Other Derringers

Send Self-Addressed Stamped Envelope to:

sandalmaker

Dept. S, 1334 Westwood Blvd., Los Angeles, CA 90024

ENOS Metalcraft

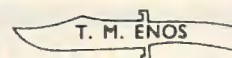

Custom Knives

ROUTE 1, BOX 66
WINTER GARDEN, FLORIDA 32787

Catalog \$1.00

TASER TF-1 Non-Lethal Electronic Stun Gun

Does Not Need To Hit A Vital Area

Two-Shot Device With The Capability Of Rapid Fire

Immediate Immobilization Of The Most Dangerous Subject

Perfect For Clandestine Operations

Immobilize Now - Interrogate Later

Weight: 1.3 lbs. Length: 9 inches Useable Range: 18 ft.

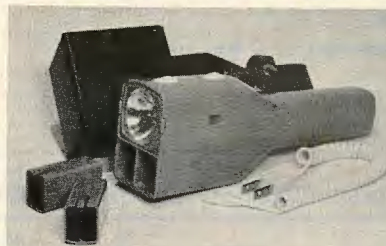

TASER TF-1 Unit(s) - \$169.00 Each - Includes Two Cartridges,
Holster, Recharge Cord & Operation Manual \$199.50 Retail
Six-Pak Cartridges - \$42.00 Each - \$55.00 Retail

I certify that I am 21 years or older Signature _____

"TF-1 FULLY WARRANTED FOR ONE YEAR"
Make Checks & Money Orders Payable To

C.M.A. ENTERPRISES

5679 Manchester Road, Akron, Ohio 44319

LIMITED NUMBER OF TF-1 UNITS AVAILABLE
WE WILL NOT BE ABLE TO DIRECT SHIP TF-2 UNITS

FULL AUTO

(continued from page 8)

produced an immense muzzle flash, louder-than-normal report, and ear-splitting muzzle blast. After all, SMGs are pistols in the first place because they fire a pistol cartridge, right?

Yet, in spite of its inherent drawbacks, the "XM" generally accomplished its mission well and though it is no longer in service on a T.O. & E. basis in the U.S. military, many can be found throughout the world, courtesy export sales by its originator, Colt Firearms, Inc.

On the U.S. Class III market, an XM or CAR will cost upwards of \$1500, and many military and police agencies would love to own a couple but shy away because of the high cost per unit.

Realistically, the XM/CAR is a good choice for urban or vehicular use for the same reasons it worked in Vietnam, and now anyone who owns a basic M-16 or AR-15 can convert his gun to either a

CAR-15 or an XM-177E2 for less than \$200.

B&H Service Co., Natalia, Texas, is now offering, on a production basis, the entire assembly of parts necessary to convert an AR-15 or M-16 to a CAR. Included in the kit are a barrel with legal flash suppressor permanently attached to achieve legal U.S. length of 16½ inches, short handguards, handguard cap, shortened gas tube, front sight base, and a barrel nut wrench . . . all for \$99.95. All parts are manufactured to original U.S. Government specifications and finished in the appropriate military style.

All that is necessary to convert one's gun is to assemble the kit and fit it to an AR-15/M-16 upper-receiver. The assembly time is approximately 30 minutes if you wish to do the job yourself or, if you prefer, B&H Service will do the job for you for a \$12.00 fee. The quality of this kit is excellent and well worth its price.

To make a complete conversion to the XM-177E2, one must have the telescop-

ing buttstock assembly, and these can be obtained from Lock, Stock, & Barrel, 20211 Prairie, Chatsworth, CA 91311, for about \$80.00. Parts included in the kit are the telescoping stock, shortened buffer tube, buffer, and all of the miscellaneous parts required to mount the apparatus on a standard AR-15/M-16 lower receiver.

The quality of the kit is superb, with all of the parts being manufactured to government specs. Attachment of the kit takes about 15 minutes, using the detailed instructions furnished by the manufacturer.

Personally, I feel that the XM or CAR offers a much superior alternative as a general-purpose weapon than does the AR-15 or M-16 and possesses the added advantage of doubling as an excellent survival rifle that stows easily in an aircraft cockpit or vehicle.

So, if you are using the AR-15/M-16 and feel the need for a more compact weapon, a letter or telephone call to Lock, Stock, & Barrel or to B&H Service can change your situation for the better.

More on Phoney caliber .30 carbine Muzzle Brakes

Cpt. Mike Stratton, of the CARBINE CLUB, 1008 Boulevard Street, Salem, VA 24153, recently wrote me in regard to my comments in "FULL AUTO" (September 1977 SOF) about phoney caliber .30 carbine muzzle brakes being sold as originals by a number of firms.

Cpt. Stratton advised me that the original GI muzzle brake (recoil check) is usually marked on the bottom with the letter "U" or "NLD." In addition, the letters "NL. . .," and a combination of a third letter are sometime encountered.

Any other lettering combinations encountered should be cause for immediate suspicion and subsequent investigation of the product prior to purchase.

Reliable Explosive Handgun/SMG Ammo Now Available

Velex Weaponry Co., N. 6809 Lincoln, Spokane, WA 99208, has introduced a line of explosive ammunition for handguns and SMGs. The ammo features what is termed a "recessed discriminating impact fuze, similar to those found in artillery shells, with a projectile filled with explosive compound" to prevent detonation in the weapon while insuring explosion upon target impact.

I have test-fired some production samples and found that they accomplish everything that Velex claims. Amazingly enough, the ammunition testing detonated on, and literally destroyed, empty coffee cans in spite of the light resistance encountered by the bullet. In my Beretta M-34 .380 pistol and in the Ingram (MAC) M-11 .380 SMG, Velex functioned flawlessly, while giving the .380 ACP the measure of authority it badly needs to be effective.

The Velex people advised me that they are marketing their ammo in .380 ACP



OLD SARGE

presents

THE SHORTY



A Complete Kit For Your AR-15 M16 to Convert to The XM177 Type

- Kit includes everything plus Complete Instructions *
- Pair of Shorty Handguards with Liners **\$29.95** separately
- Handguard Cap **\$ 3.95** separately
- Gas Tube W/Pin **\$12.00** Separately
- Barrel Assy. W/Barrel Nut, Front Sight Base, Sling Swivel & a Permanently Attached Suppressor **\$69.95** Separately
- And A Barrel Nut Wrench **\$12.50**

\$99.95

Complete Postpaid

Complete Unit is Only 17 Inches Long!

- Gunsmith Service - No FFL required *
- DON'T SEND YOUR WHOLE GUN
- just the upper half - and our military trained smith will convert it for you for only **\$12.00**. You pay postage to us. We pay shipping back to you.
- Barrel Exchange Program *
- You can trade in your old barrel if you desire. If it passes inspection then we'll give you \$10.00 off or convert your gun without a gunsmith charge of \$12.00 above. Knock off another \$5.00 if you don't want the wrench!

The Advantages Are Apparent

- Fits all M-16's, AR-15's
- Legal length - no special permit required
- Immediate Shipment
- The barrel itself is same as standard 12" Military barrel for CAR
- Perfect for SWAT & TACTICAL UNITS
- Drastic reduction of length makes gun easier to use in confined space - makes it lighter, more portable, more apt to be there when you need it - and THAT'S when it COUNTS.

BH SERVICE

PO Box 479, Natalia, Texas 78059

Call the Sarge 9am to 6pm

1 (512) 663-9913 / 663-9918

M-16 ACCESSORY SPECIALS

1. Bipods - New w/new latest canvas case. \$10.95
2. Above w/cleaning kit in case complete. \$13.95
3. L.S.A. 4 oz. squeeze bottle, ea. \$ 1.95
- 3 for \$ 5.00
4. L.S.A. in qt. can. \$ 9.95
5. L.S.A. by the case 24-4 oz. btl. (best price). \$23.00
6. .223 Ammo Pack w/14 strippers 7 covers, 1 bandoleer, 1 guide, makes it just like GI. \$ 1.95
7. 10 of the .223 Ammo Packs - enough for 1400 rds. of ammunition \$15.00
8. Silent Sling, very latest GI, new. \$ 2.95
9. 20 rd. magazine, ea. \$ 2.75
- 7 for \$18.95
10. 30 rd. magazine by Colt. \$10.00
11. Nylon 30 rd. pouch, GI new. \$ 5.95
12. CAR - 15 Flash Suppressor. \$14.95
13. Magazine charger for stripper clip. \$.35
- 3 for \$ 1.00
14. 22 cal. Cleaning Rod separately (4 piece E2). \$ 4.95
15. M-16 30 rd. CLA style, w/shoulder strap & belt loop, holds 3. \$ 3.00
16. 2-20 rd. Mags. in special issue rare pouch, as new. \$ 5.95
17. Colt 30 rd. Mag. Set - 3 mags. w/latest issue nylon pouch all new. \$24.95

AR-15 PARTS SALE

Flash Suppressor CAR TYPE.	\$14.95
Hammer or Trigger Pin.	\$.95
Triggers.	\$ 7.95
Trigger Springs.	\$.95
Hammers.	\$ 8.95
Hammer Springs.	\$.95
Mag. Catch Bar.	\$ 1.85
Mag. Catch Button.	\$ 1.85
Mag. Catch Spring.	\$.75
Selector Lever.	\$12.50
Extractor.	\$ 3.50
Extractor Spring.	\$.50
Handguard Slip Ring.	\$ 2.50
Handguard Snap Ring.	\$ 1.25
Weld Spring.	\$ 2.00
Gas Tube Pin.	\$.50
Front Sight Assy. (No Base).	\$ 5.00
Bolt Catch.	\$ 1.95
Bolt Catch Pin.	\$.95
Bolt Catch Plunger.	\$.50
Bolt Catch Spring.	\$.50

-Most other parts in stock -

KM-177 E2 BUTT STOCK ASSEMBLY

PARTS LIST

- 1 Nut, Lock Pin
- 2 Lever, Release
- 3 Pin, Lock
- 4 Spring, Locking
- 5 Stock, Butt, Sliding
- 6 Body, Buffer
- *7 Spring, action [not Supplied must be made by cutting down original AR15 spring 2 1/2".
- 8 Extension, Lower receiver
- 9 Plate, End, receiver
- 10 Nut, Receiver extension

*All parts numbered are included

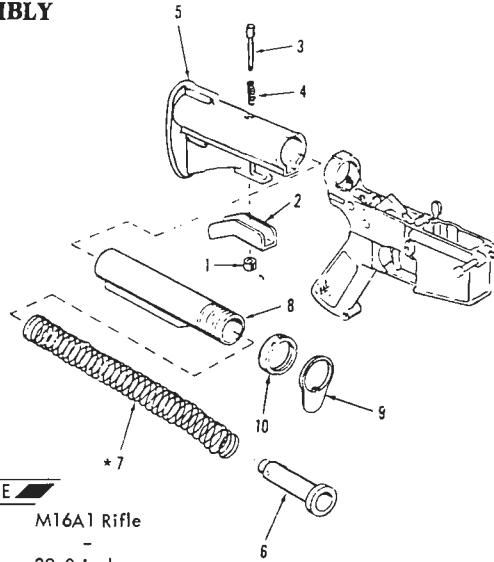

COMPARISON with the M16A1 RIFLE

	CAR-15 SMG	M16A1 Rifle
Length stock closed	28.3 inches	-
Length stock extended	31.0 inches	39.0 inches
Barrel length	10.0 inches	20.0 inches
Width	2.4 inches	2.4 inches
Height w/magazine	10.2 inches	10.2 inches
30 rounds		
Weight empty	5.2 pounds	6.3 pounds
Weight loaded	6.2 pounds	7.3 pounds
Muzzle velocity	2750 feet/sec	3250 feet/sec
Cyclic rate of fire	750 rounds/min	750 rounds/min
Maximum rate of fire	200 rounds/min	200 rounds/min
Maximum effective range	350 meters	460 meters

(9mm Kurz/Corto), .38 Special, 9mm Parabellum, .357 Magnum, and .45 ACP. Particularly in the case of the .380, .38 Special, and 9mm Parabellum, Velex ammunition will improve the relative stopping power (RSP) of the cartridge to the point of being adequate for combat use while providing a solution to the problems of ricochet and over-penetration that are so prevalent with these calibers.

How effective is Velex? A 5-lb. coffee can full of water shot with .38 Special Velex ammo, from a S&W M-66 (2 1/2-inch bbl.) deposited its contents all over the ceiling of the range (about 12 feet high) and moved visibly backward upon detonation of the projectile, coming to rest almost a foot to the rear of its original location. Upon examination, the can was visibly bulged, and the backside of it was shredded from the explosion!

Overall, I would have to say that one who carries anything but the most potent of handguns would be well advised to purchase this new, **highly effective** ammunition.

An interesting sidenote on the subject applies to the use of Velex in short-barrelled revolvers. For many years, it has been a known fact that **any** cartridge under .40 caliber, fired from a snubie, was sadly lacking in stopping power, including the .357 Magnum. The use of Velex radically changes this picture since its effectiveness is not dependent upon velocity.

If you didn't sign the Geneva Convention and carry a handgun that is less than .40 caliber . . . this ammunition could well save your life! Admittedly, it is a bit expensive, with a packet selling for almost \$10, but . . . how much monetary value can one place on his own life???

Cartridge	Bullet Weight	Velocity (fps)	Energy (ft. lbs.)
.380 ACP	87	1092	230
9mm Parabellum	92	1373	385
.38 Special	101	1144 (4"-bbl)	294
.357 Magnum	101	1439 (4"-bbl)	465
.45 ACP	200	972	420

VELEX, INC.

Comparison of Relative Stopping Power—Conventional Ammo Versus Velex

Cartridge	RSP	Cartridge	RSP
.380 ACP-RN	15.0	.357 Magnum-RN	27.4*
.380 ACP-HP	27.9	.357 Magnum-HP	51.7*
.380 Velex	58.0	.357 Mag. Velex	111.0
9mm Luger-RN	24.5*	.45 ACP RN	49.8
9mm Luger-HP	46.3*	.45 ACP HP	70.0
9mm Lug. Velex	98.0	.45 ACP Velex	180.0
.38 Special-RN	20.3		
.38 Special-HP	35.7		
.38 SPL Velex	77.0		



*Exits Target

D-ANN MARTIAL ARTS SUPPLY CO.

OVER 150 DIFFERENT ITEMS



SHOCK RESISTANT PLASTIC YAWARA STICK. GUARANTEED NOT TO BREAK. \$10.00 POST. PD.



PUSH DAGGER WITH 4 1/2" LONG SINGLE EDGE BLADE, WOODEN HANDLE & CARRYING CASE. \$20.00 POST. PD.

ILLUSTRATED CATALOG \$2.00

FREE CATALOG WITH ORDER

P.O. BOX 41592, DEPT. S CHICAGO, ILLINOIS 60641

NEW, JUST OUT!

SECRET NAZI POLAR EXPEDITIONS — To Establish Future UFO Bases?

Hitler's frantic pre-war exploration of Antarctica is documented here for the first time. Based on interviews of Nazi Expedition members. Once Top Secret photos and rosters are revealed along with amazing discoveries — warm water lakes, heated caves, huge mountains and abundant sources of natural foods. The rigors of Polar combat — men versus men and men versus the mighty elements! Hitler's Arctic Battalions fight the U.S. Coast Guard to a photo finish! 40 rare photographs, 20 maps, 5 illustrations. Terrific reading! \$4.95 plus 75¢ postage.

165 LITTLE KNOWN UFO SIGHTINGS FROM AROUND THE WORLD.

An information-packed volume. Thirty years of uncensored, unabridged news reports of on-the-scene eyewitness interviews from the far corners of the world. A great book to show the skeptics! 90 photos and illustrations. Includes two maps showing UFO bases and sightings. \$2.95 PLUS 75¢ postage.

\$4.95 SPECIAL OFFER

U.F.O.'s NAZI SECRET WEAPON



160 Pages, \$4.95

The complete story of Nazi Germany's Secret Weapon-UFO Program. 160 easy to read pages. Colourful Cover. Large 8 1/4" x 5 1/4" format. 145 Photographs. 74 Engineering Drawings and Illustrations. 5 Maps (showing U.F.O. Bases, etc.) 63 Photostatically reproduced, reports of sightings from around the world. Starting from 1943 to the present. Many never before published photos and other material. This book is only sold direct by the authors-publishers. \$4.95 plus 75¢ postage.



SAMISDAT PUBL. LTD.

206 CARLTON STREET Dept. TORONTO, CANADA S4A

Satisfaction guaranteed or money refunded

New!
by W.A.K.

Length
Folded = 6 5/8"
Opened = 12"
Weight = 1 lb.

\$14.95 ppd.

**"ATCHISSON FOLDING"
HUNTER**

A weapon as silent as a slight breeze—for that uneasy situation. Acclaimed by fighting forces, mercenaries, and men of action.

Amazing accuracy through gyro-like action. The kinetic energy produced will penetrate 3/4" plywood at 20 yards!

This four bladed hunter is easily thrown and always sticks—takes down easily to fit pocket or pack, opens instantly for emergency use.

Made of high quality, tough carbon steel, heat treated to Rockwell 55-60 Rc. with hard black oxide finish.

Another quality product by W.A.K.
Distributed WORLDWIDE by:

BINGHAM LTD.
3609 Shallowford Rd., N.E.
Suite 105-D
Atlanta, Georgia 30340

PHONE: 404-455-0050
DEALER INQUIRIES INVITED.

WANTED
Registered and amnesty automatic weapons and Vietnam-era materials.
BEST PRICES PAID BY R.J.PERRY & ASSOC. INC., PO BOX 151, DEPT S, PARK RIDGE, IL 60068.312-696-0930

NEW! ...The "FLICKET"

OPENS LOCK-BACK BLADES FASTER THAN A SWITCH BLADE WITH A FLICK OF A THUMB...LEGALLY

Converts most lock-back blade knives to a one hand operation for fast protection. Actually timed at 1/400th of a second... even with gloved hands. Made of heat treated spring steel, nickel plated. Please specify your knife make, model and length of blade when open, when ordering.

Only **\$2⁹⁵** oa. ppd. Knife NOT Included
Cash, M.O. or Cert. check. Add 5¢ if cash.

DEALER INQUIRIES INVITED Phone 404/983-3570

C.K.C. MFG. CO. 110 CROGAN ST., DEPT. S.F., LAWRENCEVILLE, GA. 30245

STEELE ON KNIVES

(continued from page 15)

Gravity knives are as fast as switch-blades, and they have the advantage of no flat opening spring which is held under constant stress. However, the only good ones I know of were made in Solingen, the best known being the Nazi paratrooper knife (and one of these in good condition will cost more than \$100).

The rocker-locked folding hunter, the Barry Wood Mark 2, and the Filipino balisong all can be opened one-handed (see my knife book for instructions) and make good last-ditch fighting knives. The balisong, or Batangas butterfly knife, may be fairly difficult to obtain. The Barry Wood knife is excellent but sells for collector's prices and, unless you know someone who has one, involves a long waiting list. Most of the rocker-locked folders are factory made and usually do not cost over \$30. I recommend the Puma 265, the Gerber FS II, and the comparatively inexpensive folder made by Friedrich Herder and Sons of Solingen. For this type of knife the best blade length is between three and four inches. Of course, no knife should be considered for defense that does not lock open.

Q. I found the letter by C.R.R. of Illinois in the current issue of SOF to be most interesting. The gentleman to whom C.R.R. refers, Charles Nelson, was one of the people with whom I studied, about 16 years ago in New York. In fact, my own system, COMBATO, is an outgrowth of Nelson's ideas among many others, a system oriented purely to self-defense.

Your comment about the need for a HARD thrust when using a knife is perfectly correct; in fact, you are the first person who I know of (besides myself) that stresses this point in teaching the combat employment of the knife. I might point out several other items which deserve to be repeated:

1. TWISTING the blade upon full entry - up to the hilt - maximizes shock and thoroughly incapacitates, very rapidly.
2. Prior to actual engagement with an opponent, it is best, when possible, to CONCEAL one's blade, and to offer the apparent "front" of an unarmed fighting stance (blade hidden along rear of the thigh).
3. Mid-section thrusts, eye and neck (throat) attacks are the best by far.
4. It cannot be stressed too often that SOMETHING TOSSED INTO THE ENEMY'S FACE PRIOR TO BRINGING THE KNIFE INTO PLAY is a basic, effective fighting strategy. Pebbles or sand carried in the pocket is perfect for this purpose.

Bradley J. Steiner, Phoenix, AZ

A. Thank you for your letter and for sending along a copy of your booklet, The Tactical Skills of Hand-to-Hand Combat (Self-Defense). All of the comments in your letter are worth emphasizing, though let me remind readers that it is usually necessary to attack the opponent's hands (whether he is armed or unarmed) before going for #3. With good combination attacks the sequence from hand cut to killing thrust is immediate and automatic.

The principles you list in your booklet are excellent, beginning with "the only rule in street fighting is that there are no rules." One example of your philosophy I found particularly striking. "If I take it upon myself to threaten you with violence, and if you, instead of cowering in fear as I had hoped you would, suddenly spit into my face and kick me as hard as you can, and then pull a folding knife once I go down, so you can finish the job, THE FAULT IS ALL MY OWN!"

It is unfortunate that the courts still insist on judging a fight as if it were a sporting contest. If I threaten or insult you may threaten or insult but not use violence. If I assault you (draw back my fist or brandish a weapon) you may take equal countermeasures, but may not continue your attack after I have desisted in my assault lest you then become the aggressor. Those of us who have dealt first-hand with hundreds of the delinquent dirtbags who now infest our schools and streets and who commit most of the nation's violent crime (according to a recent survey), know that the only answer seems to be massive counter-violence AT THE TIME OF THE INCIDENT. Unfortunately, whole categories of persons, including teachers, probation officers, corrections officers, police officers, who have to deal with these "people" every day are constrained under job and legal penalties from defending themselves in the best way possible. For example, I knew one

180-pound juvenile hoodlum who was high on "angel dust" when he robbed a store. The police surrounded him, while he shouted, "Shoot me, motherfucker." In spite of his being armed with a pistol the police still managed to take him alive, for which I'm sure the taxpayers are eternally grateful.

I knew a substitute teacher who was strong-armed in one ghetto school and had a trash can dumped on him in another. He was told by the principal that they could not invite him back (curtailing his salary in that respect) because they could not guarantee his safety. So, in effect, he was punished twice, being assaulted and losing that job, while the hoodlums ran free (it's hard to identify a suspect with a trash can on your head). He would have been better off fighting tooth-and-nail and worrying about the consequences later, than trying to retain the manners and ethics of an essentially middle class system in an area where those values have no meaning.

P.S. In my last column I mentioned I might have more information on hunting wild boar with dogs and a knife. Since then I have travelled to Hawaii, the Big Island, to research the subject for myself. My guide, Calvin Pacheco, said that I was the first *haole* from the mainland to want to "poke da pig" Hawaiian style.

A hunt like this involves quite a bit of endurance. I was glad that I had kept at my running and jumping rope as well as my *caranza* (Filipino *escrima* knife and stick exercises). The typical hunt includes a five to ten-mile hike up lava flows, through forests, and across shallow swamps. Then when the dogs finally hit a good scent, and you hear them barking, you must run, slide, stumble, and climb that last half mile or so to where they have the boar cornered (you must do this quickly, or you may find some dead dogs when you do arrive). Finally, you must decide when to go in, then without hesitation thrust to the throat or under the leg into the heart.

I was in Hawaii for a week, hunted four days, killed three boar with a knife, two of which were over 150 pounds. My most exciting moment came when I had just poked one of these larger ones in the neck with my six-inch Randall fighting knife. He turned on me just as I lost my footing in the mud. There I was, sitting in the mud, facing a very angry boar, and realizing that only one dog was close and he did not have a firm grip on the pig. I extended both hands, *kali* fashion, expecting the charge, but apparently my first "poke" (a rip six inches deep and two inches wide) had done its work; the boar did not move. I waited till the dogs got a good grip once more, then I went in for the kill.

As far as knives for this type of hunting are concerned, my conclusions are that it should have a 7½ to nine-inch bowie or spear point blade with a ricasso

in front of the guard. It must have a sharp point to get in past heavy neck muscle. The blade length allows a deep thrust into neck or heart, while still allowing control for the rip through the windpipe. The ricasso allows a firm grip (with first finger wrapped around it) so the boar cannot knock it out of your grasp by twisting his head. Sawteeth, such as on the Randall Model 18, might come in handy for ripping through neck muscle or severing the head (a heavy nine-inch blade is also useful for chopping off the head as well as for cutting through thick brush). Among the better knives I could think of for this work would be the Randall 7½-inch Model 18, his eight-inch Model 1, and his eight-inch Bear Bowie. Bob Lofgreen's "Combat Bowie" would also be excellent.

Those interested in such a hunt should write:

Calvin Pacheco
P.O. 206 Pepekeo
Hilo, Hawaii



**ORIGINAL
BRITISH COMMANDO**
ORDNANCE MARKED

BRITISH COMMANDO KNIFE made by George Ibberson Co., Sheffield, England. This is a British Government order overrun and every knife is stamped with Ibberson's name and trademark, ordnance number and current year of manufacture. The handle is covered in black and each knife has an authentic issue, metal-tipped, leather sheath as pictured above. Size is 11¾" and condition is new. Price: \$16.99 each plus delivery of \$1.25. Factory letter of authenticity comes with each knife.

MATTHEWS CUTLERY
BOX 33095 • DECATUR, GA. 30033
PHONE 404-636-7923

knives

• illus. shows bayonet and scabbard assembled for wire-cutting operation.

■ Shipping charges:
add \$1.50/bayonets;
\$1.00/all other knives.

NAVY ARMS COMPANY 689 BERGEN BLVD., RIDGEFIELD, N. J. 07657



The NEW Incomparable SKIN-DOO

A unique leg-sheathed knife with a Velcro closure system for utmost concealability. The 4½ ounce suede leg wrap is so comfortable you'll forget it is there. The polished blade, hollow-ground knife is superbly hand-crafted of heat treated 440-C steel. Knife unit is 5" long, ⅜" thick and weighs less than 2 ounces. A functional tool for outdoorsmen, or as a weapon for personal defense & evasive tactics—easily removed for instant use! The SKIN-DOO comes with an extra suede sheath with Velcro closure adaptable to boots, pocketbooks, or anywhere!

ORDER YOURS TODAY!

Complete with two sheaths:



plus \$1.00 for postage and insurance.

PHONE 404-943-9336 (24 hour service)

BRIGADE QUARTERMASTERS LTD.

P.O. Box 108-L
Powder Springs, Georgia 30073
DEALER INQUIRIES INVITED

WW II BATTLE PHOTOS

Official Army, Navy & Marine 8x10 glossy photos. Pacific Aircraft carrier war, Iwo Jima, Saipan, D-Day Normandy, St. Lo, Battle of the Bulge, Hurtgen Forest. Send 50c for list state Army, Navy or Marine. All 3 lists \$1.00.

REAL WAR PHOTOS BOX 728-F
HAMMOND, IND. 46320

1. **AR15 or M16 ALL PURPOSE SPECIAL FORCES BAYONET**—Incorporates steel hacksaw back-edge, special wire-cutting feature with insulated handle and scabbard for cutting high tension power-lines, secret compartment in handle. Mint condition—a rarity patterned after German WWII special purpose bayonet. PRICE \$29.95 each (5 for \$110.00)

2. **FAMOUS GHURKA FIGHTING KNIVES**—Original military issue with British Broad Arrow Marking and wood handle. PRICE \$7.50 each

3. **GAMBLERS "DIRK"**—Ivory handle. PRICE \$20.00 each

4. **INDIAN TRADE KNIFE**—Bi-Centennial Indian Trade Knife "Harrodsburg, Kentucky 1774-1974". This limited run commemorative replica is a close copy of the type of knife issued to the Indians by the British for the assault on Fort Harrod and Boonsboro. All knives are serial numbered, have a 10-inch blade, red painted hardwood grip and brass hilt. Blade is marked with British Broad Arrow. PRICE \$15.00 each

J.R. HOPKINSON, LTD. RIFLEMAN'S KNIFE

J.R. Hopkinson, Ltd. of Sheffield, England, one of the oldest knife-making firms in England, has custom tailored a traditional Rifleman's Knife for Navy Arms. It features the finest Sheffield super-sharp hand-forged blade with wooden handle and polished brass cross guard. PRICE \$20.00

SEMI-AUTOMATIC BLANK GUN

~ ALL METAL CONSTRUCTION, BLACK, 6-SHOT, IMPORTED FROM WEST GERMANY. INCLUDED 100 ROUNDS OF

BLANK AMMO

NOT SOLD IN NEW YORK OR CALIFORNIA OR TO MINORS.

ALLOW FOUR WEEKS FOR DELIVERY. SEND \$21.00, CHECK OR MONEY ORDER.

POSTPAID ANYWHERE IN US. LAWRENCE M. COHEN IMPORTS, 409 JAMES STREET, UTICA, N.Y. 13501.

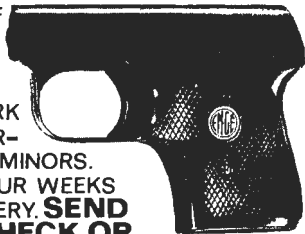

IN REVIEW

(continued from page 16)

was not until Carlos personally dispatched two of their top security agents that the French began to crack down.

The West German government has given in several times to kidnappers' threats and treated captured members of the Baader-Meinhof gang with kid gloves and special privileges (the original jail break of Andreas Baader by Ulrike Meinhof was engineered while Baader was given leave to research a book he was writing). Chancellor Kriesky of Austria was extraordinarily weak and conciliatory during Carlos' OPEC operation and the United States itself is seen by the authors as a particularly ineffective link in Western anti-terrorist security. "Why don't you ask the British and the French; they know more about terrorism than we do," says our own Inter-Departmental Working Group on Terrorism.

It is freedom which the terrorists ultimately aim at and freedom which they ironically exploit to secure their goals. "Freedom of speech and of the press, is here their essential weapon," say Payne and Dobson. "If the world had not been watching; if the deed had been done in secret, Black September could have murdered the entire Israeli team [at Munich] and yet it would have failed utterly. Freedom of the press is essential to terrorism. For that reason terrorism could never succeed in the Soviet Union. There, unless there are political reasons for reporting a piece of news, as in the case of the amateurish attempt by a group of Jews to flee from Russia in a hijacked plane on June 15th, 1970, it is simply not reported."

Groups of terrorists, say the authors, "crave only attention and power. The proof of their insincerity in demanding change is that there is no example of international terrorists striking at those parts of the world where left-wing tyrannies rule with a heavy hand. Violent protest never hits at the real tyrannies, whether they are effective right-wing governments or Communist dictatorships. Their target is democracy..."

BRINGING DOWN AMERICA: An FBI Informer with the Weathermen, by Larry Grathwohl as told to Frank Reagan. New York: Arlington House, 1976. Hardcover, \$7.95; 184 pages and six photos. Review by N.E. MacDougald.

Although *Bringing Down America* is as dated as love beads, it still merits reading. American political ambience in 1977 is so different from that of the late 'sixties when the story takes place, that it is difficult to relate to parts of the book. But hindsight's wisdom should not prevent one from reading this chronicle of last generation's most militant political group.

Larry Grathwohl, our hero, is a lovable sort: A Vietnam vet attending college on the GI bill, trying to support a wife and

child. His father-in-law, a Godfearing ex-cop, encourages Larry to spy on the Weathermen. He does, and the seamy and often routine story connects events that would otherwise be thought unrelated.

For one year Larry Grathwohl led the proverbial "three lives." During this time, he learned about the Weatherman infrastructure, and about their liaison with other radical organizations such as the Black Panthers and the White Panthers. Basically, the book explains the strategies and tactics of "struggle" (an euphemism for violent revolution). The overall strategy was deadly simple: kill the "pigs" and overthrow the U.S. Government by any means possible. The tactics were crude, but dynamite or molotov cocktails effective enough to account for numerous needless deaths.

For anyone who has not read about or lived the counterculture lifestyle, the book will be more interesting. **Bringing Down America** should be enlightening to all radical-watchers, no matter their political orientation. Fuzzy-thinking liberals may find the Weathermen were not misunderstood college kids crusading for a more egalitarian government. Red-neck rightists may find that they were not so paranoid as others thought.

As I stated in the beginning, the book lacks timeliness. Make no mistake, however, **Bringing Down America** may be out-of-date but it is not obsolete.

One point the author makes superbly: the Weathermen gave little thought to what will happen after the Revolution:

The irony of Weathermen thinking or philosophy is that they probably couldn't live in the society they would impose on the U.S. should the revolution succeed.

Most Weatherman planning and strategy goes into implementing a revolution and not into setting up a viable government afterward. However, when they did discuss this postrevolutionary period, their plans were frightening. Their society would make George Orwell's 1984 a pleasure to live in.

If **Bringing Down America** were a movie, you would be well advised to wait until it was rerun on TV. Since it is a book, you are advised to check it out of the library, or peruse it in the bookstore before paying the asking price.



WE BUY & SELL OLD WAR SOUVENIRS

GENUINE THIRD REICH BATTLE FLAGS!!



All with the original halyards and markings-very good to excellent condition, about 3x2 ft. Limited supply - \$18.50 while available. Order now for immediate delivery. Satisfaction fully guaranteed or your money refunded. Also send for our free catalog of many other exciting German and miscellaneous military collectibles.

Delta International Box 631 Dept SF Lafayette Calif 94549 (Dealers please inquire)

FOR SALE

- | | |
|--|----------|
| 1. WAFFEN SS PULLOVER | \$150.00 |
| 2. WAFFEN SS OVER-PANT | \$ 75.00 |
| 3. WAFFEN SS HELMET COVER | \$ 40.00 |
| 4. WAFFEN SS PULLOVER SET
(#1, #2, #3) | \$250.00 |
| 5. WAFFEN SS FOUR POCKET
HBT TUNIC | \$150.00 |
| 6. WAFFEN SS HBT PANT | \$ 75.00 |
| 7. WAFFEN SS HBT SET
(#5 & #6) | \$200.00 |
| 8. WAFFEN SS PANZER WRAP-
AROUND JACKET | \$150.00 |
| 9. WAFFEN SS PANZER PANT | \$ 75.00 |
| 10. WAFFEN SS PANZER SET
(#8 & #9) | \$200.00 |
| 11. WAFFEN SS M-43 CAP
(ANY PATTERN) | \$ 40.00 |

All items are reproduced in exact detail and are authentic in design. * Any piece of these replica SS camouflage will be a fine addition to your collection at a fraction of the cost of original items * A sample of material, your choice of pattern, and the history of Waffen SS camouflage is available at a cost of \$3.00 * The price of items with a full description and the history of Waffen SS camouflage is available for \$1.00.

When using your Master Charge or Visa/Bank Americard for ordering call us toll free at 1-800-851-4557. All orders received with checks are held four weeks before merchandise is shipped. Illinois residents add 5% state sales tax. Please add \$5.00 per order for United States Parcel delivery. Any orders not shipped by U.P.S. please add \$10.00 per order for postage and insurance.

R.S. SALES
P.M. MANUFACTURING
DIVISION

2229 Vandalia
Collinsville, Illinois 62234
U.S.A.

GERMAN ERMA ARMS

SWISS AMT RIFLE
PERSONAL SERVICE
DEALER ENQUIRIES
ONLY PLEASE

EXPORT UPON EXPORT PERMIT

CONTACT: LAWRENCE M COHEN
IMPORTS, 409 JAMES STREET
UTICA NEW YORK 13501 USA

CLASSIFIED

THOMPSON 1928 Submachine gun replica models. Full-size, wood and steel construction. Completely finished and assembled—\$35.00 ppd. Dealers inquire: Repro-Products, P.O. Box 71, Prairie View, IL 60069.

OVERSEAS JOBS! All Occupations! Complete Details. Where and How to Apply. Latest Company Lists. Resume Tips. \$2.00 Information Services, P.O. Box 3345-F, Cocoa, Florida 32922.

FAMOUS "LION-HEAD" SWORD CANE, \$30.00; **SWAGGER-STICK** with blade (Specify "Lion"—\$20.00 — or Leather-covered—\$22.50); inquire for other specialties. Robert Ross, 417 West 56th Street, New York, New York 10019.

WANTED—Inert Hand Grenades, Mines, Demo items from all countries. All letters answered. C. Mathiesen, P.O. Box 169, Warwick, RI 02887.

BECOME A PART-TIME GUN DEALER! Obtain a Federal Firearms License! 1977 Booklet, ALL APPLICATION FORMS—\$2.00. DELTA PRESS, Box 5093-F, Shreveport, Louisiana 71105.

SURVIVE-ALL Knife Fighting film, Super 8 B&W, approximately 200 feet. \$26.50. Home training textbook, unarmed defense against a knife, stick and gun. Fifteen attack situations. \$2.49. CA. Residents 6%. Nine various films available on Ju-Jitsu. Send check or money order to: Prof. Harold D. Brosious, 290 Verde Vista Drive, Thousand Oaks, CA 91360.

SURVIVAL / MILITARY / GUERRILLA WARFARE TRAINING MANUALS/BOOKS . . . "SURVIVAL" FREEZE-DRIED FOODS . . . LATEST CATALOG 50c . . . KEN HALE (SOF-50), McDONALD, OHIO 44437.

RANDALL MADE knives at list prices. Large stock, lay-away plan. Catalog \$1.00. Douglas Kenefick, 19 Leander Street, Danielson, CONN 06239.

TEAR GAS SPRAY, heavy duty, wear in shirt pocket or clip to belt. \$9.95 plus \$1 ppd. and hdg.; J. Bolger, Agent, 14813 Dorrance, Bridgeton, MO 63044.

Curious about seemingly treasonous U.S. foreign policy? Why do so many rich people in the world support Communism and Socialism? Who is trying to take over the world? Who really controls? Read **NONE DARE CALL IT CONSPIRACY AND WHAT IS THE JOHN BIRCH SOCIETY?** Send \$1.00 to American Opinion Bookstore, 1410 Waukegan Rd., Glenview, IL 60025.

FOR SALE: Garand, M-1, original—\$425.00, M-1 Carbine, original—\$200.00, CETME, 7.62 NATO, with muzzle brake, sling, 20—round magazine, almost new—\$765.00, many others. The Garand Man, 21 Lancaster Road, Island Park, New York 11588 (516-432-8852).

MERCENARY: Ex-ABN, military and sport parachute exp. pilot: mel; sel; ses. Proficient hand and shoulder arms. Familiar most crew served weapons. Exp. Scuba and Desco. Exp. Lat. Am/Caribbean. Contract/Full time. RCG, Box 3224, Pompano Beach, FLA 33062.

BOWEN STAINLESS STEEL BELT BUCKLE KNIVES, WITH BELT. EXCELLENT BACK-UP WEAPON. LIFETIME GUARANTEE. \$24.00 POSTPAID. SPECIFY: SINGLE EDGE OR DOUBLE EDGE. BELTS: EVEN SIZES 30" to 50", BROWN OR BLACK. C.M.A. ENTERPRISES, 5679 MANCHESTER ROAD, AKRON, OHIO 44319.

PRACTICAL field quickest sun star positions directly onto topographic maps, equally good ships and boats. Almanac tables figuring already done, with Hewlett Packard 67 and my custom program cards. Set, including dead reckoning \$27.00. Special orders any numbers you need. Carlat Monser, Box 77 RR 1, Freeman, MO 64746 (816) 758-6883.

A WARRIOR'S RELIGION—Rather be a wolf than a sheep? Into courage, liberty, individualism, the family? For those who'd rather be Viking raiders than monks, we just might have an answer. Asatru's the religion, Odin and Thor two of our deities. We have no master! Asatru Free Assembly, 1766 East Avenue, Turlock, CA 95380.

WATCH BANDS, black or OD. Made from Type VIII nylon webbing, using velcro for wrist and crystal cover closures. Measure wrist circumference and send with \$4.00 PPD, specify color; To: Rigger, 5618-B S. Quaker, Tulsa, OK 74205.

AIRBORNE AND AVIATION INSIGNIA, ALL COUNTRIES. Photo-illustrated catalogue \$5.00. Fox Military Equipment Co. 16 W. 331 Jackson St., Hinsdale, IL 60521.

ARTHRITIS: Free literature to arthritis patients, medical personnel, and other interested persons. Write: The American Arthritis Association, Inc., P.O. Box 666, Chapel Hill, N.C. 27514. Attention: Robert M. Pace, Director of Public Relations.

PUBLIC RELATIONS: Patriotic organizations, orthodox Christian groups, reputable charities, and political moderates: Let me advise and/or direct concerning your public relations. Robert M. Pace, Public Relations Consultant, P.O. Box 2125, Chapel Hill, N.C. 27514.

NEW PALADIN CATALOG—Comprehensive list of U.S. and foreign books: guns, unusual weapons, knife fighting guerrilla warfare, explosives, demolition, ordnance, self-defense, technical manuals, field manuals, field craft, survival. Many unusual, hard-to-find books. Send \$1.00 for fascinating catalog. PALADIN PRESS, Box 1307-RE, Boulder, CO 80306.

DECORATIVE ETCHED RIFLE FLOOR PLATES, with scroll work and animal heads, etc. Send \$1.00 for brochure, refundable with order, to Robert Macki, 37 Hackberry Lane, Glenview, IL 60025.

MILITARY RESEARCH REPORTS CATALOG. Catalog on unusual military reports: SPIW System Reports; Silent Sniper System; Lightweight Individual Weapon Systems; Small Arms Weapons Systems; Noise Suppressors Tests for M16A1; Convoy Counterambush Weapons; Features and Characteristics of Miniature SMGs, etc. Send \$1.00. Under The Apple Tree, 5115 South Campbell, Chicago, IL 60632.

U.S. MERC FOR HIRE: African exp. Contact T. Davis, Bar "L'Edelweiss" Tel. 42-85-05, 18 Place General-de-Gaulle, Le Havre, France 76600.

CAMOUFLAGE SUITS French Algeria pattern, British Airborne smock new, Swiss, Malayan, Swedish. Embleton 29, Upper Gordon Road, Camberley, Surrey, England.

NAZI PLAQUES—Handsome reproduction cast aluminum eagle with swastika wall plaques 9"x7". Sprayed brass or polished aluminum color. \$5.95 total cost. P.O. Box 1817, Chillicothe, OH 45601.

WANTED: SIG-AMT, with bipod, muzzle brake, case and scope. Apache Box 950, Lancaster, OH 43130.

READ "The Truth about Rhodesia" antidote to liberal lies. \$1.00 C. Porter, Box 882, Fayetteville, W. VA 25840.

MATURE MAN, bartender, construction worker, other experience and presently employed in a casino wants work anywhere. For further information write: Louis Priest, 5303 Boulder Highway, Las Vegas NEV 89122.

RHODESIAN CORRESPONDENT WANTED, interests: military and firearms. Chris Newport, 16244 Malden, Sepulveda, CA 91343.

LOCK PICKING—Books & SUPPLIES—Bugging—Free Phone Calls—much more—former Agent tells ALL—send \$2.00 to: L.A.N.D.I.S., 625 Post St., Box 1038, San Francisco, CA 94109.

EXPLOSIVES. Three different, easy-to-make formulas. Simple, Powerful. \$2.00 plus \$ASE. G.L. Pearson, Rt. 4 Box 123, Sioux Falls, S.D. 57101.

TRUTH ABOUT RHODESIA booklet, gives you the right answers to our government's lies, \$1.50, P.O. Box 196, Lawrenceburg, KY 40342. OFFICIAL Rhodesian Army Applications \$2.00.

FREE! Police—Detectives—Mercenaries—and Investigators Listings of investigative Schematics, equipment and Clandestine books . . . Quimtronix, Box 548-SO, Seattle, WA 98111.

INDEPENDENT AUTHOR/INVESTIGATOR SEEKING INFORMATION AND CONTACT WITH MERCENARIES AND VOLUNTEER PROFESSIONALS, FOREIGN AND DOMESTIC, FOR RESEARCH ON BOOK. EMPHASIS ON POST-1960s EXPERIENCE AND MEN CURRENTLY ACTIVE IN THE FIELD. ALL RESEARCH AND REPLIES KEPT STRICTLY CONFIDENTIAL. CALL COLLECT: 202 785-3826 or WRITE: MR. LLOYD, BOX 32328, WASHINGTON, DC 20007.

SOVIET ASSASSINATION WEAPONS. CIA and Military Intelligence Documents. Includes descriptions, functioning, etc. of Soviet Assassination Type Weapons. \$2.00. M16A1 Lower Receiver Drawings. Complete Forging Details and Machining and Drilling Dimensions. Full-Scale, 17"x22". \$5.00. Thompson SMG M1A1 Machinist's Drawings for Receiver and Trigger Housing. \$2.00. Self-Defense Firearms Handbook: Includes the infamous Fist Gun, Sleeve Pistol, Wrist Pistol, Shoe-Heel Pistol, Belt Buckle Pistol, Pocket Watch Pistols, etc. \$3.00. Under The Apple Tree, 5115 South Campbell, Chicago, IL 60632.

UNUSUAL BOOKS. Lock picking, silencers, improvised firearms, explosives, bugging, self-defense, and more! All clandestine and military subjects! Catalog \$1.00. Box 264, Mason, MI 48854.

TRAVEL ON FOREIGN SHIPS! Good pay, no experience. Send stamped self-addressed envelope. Globe-trotter, Box 864-SF2, St. Joseph, MO 64502.

CRIMEFIGHTERS! Police, Detectives and Investigators . . . Special books tell all—How it's done . . . Lockpicking — Shoplifting — Debugging — all three books \$5.00. Don-O, Box 548-SO, Seattle, WA 98111.

NEED NEW ID? Change name/age with full-color State ID cards, drivers' licenses, birth certificates, official ID! Details 25c. Eden Press, Box 8410-SF, Fountain Valley, CA 92708.

FN-FAL, RARE T48 (U.S. FAL) bayonet, unissued, \$100.00; unissued 10 and lightweight 20rd. mags, \$12.00; Gas wrenches or sight tools, \$6.00, ORIGINAL manuals \$3.25, much more, list 25c, postage please. FALCO, Box 41367, Chicago, IL 60641.

AIRBORNE COLLECTORS: 36th ABN BG FLASHES, \$1.50 EA. SET OF THREE \$4.25 AND S.A.S.E. SHOOTER'S SERVICE, BOX 805, ALIEF, TX 77411.

"CUSTOM KNIVES." Large selection of fighting and boot knives, also hunting and folding knives. Catalog \$1.00. Crawford Knives, 205 N. Center, West Memphis, ARK 72301.

SPECIALIZED TRAINING AVAILABLE to responsible groups in the arts of "catastrophe survival" — nuclear, chemical, bacteriological warfare, economic collapse, riot, revolution, ecodisaster, etc. Intensive, tailored instruction. Will travel. Eric Rauda, Box 1221, 2000 Center Street, Berkeley, CA 94704.

WANTED: ARMALITE AR-10. SOF Editor seeks AR-10 in very good condition. Send details. Box SP98, P.O. Box 693, Boulder, CO 80302.

CARL ZEISS BINOCULARS 8x30, excellent condition. Current retail price \$519, will sacrifice for \$275. SOF, #99, P.O. Box 693, Boulder, CO 80302.

Forced Integration by Theodore Cahn. The ethics of anti-discrimination policy. A critical examination of such concepts as equal rights, equal protection of the laws and equality of opportunity. \$1.25. CM Press, Suite 3308, 350 Fifth Ave., New York, NY 10001.

THE GIDLEY CATALOG IS TOTALLY UNIQUE. DEALING PRIMARILY IN UNUSUAL BOOKS, IT OFFERS ARTICLES, CLASSIFIEDS, AND SPECIAL DISCOUNTS AND SERVICES TO SUBSCRIBERS. \$2.00 A YEAR U.S. AND CANADA. SAMPLE 50c. Thomas Gidley, P.O. Box 6706, Ft. Worth, TX 76115.

SS AND NAZI Militaria. Biggest catalog, including 2 large posters, \$1.50 (refundable). Krupper, Box 1775F Salina Station, Syracuse, NY 13208.

THOMPSON 1928 SUBMACHINE GUN REPLICA MODELS. Full size, wood and steel construction. Completely finished and assembled. \$35.00 ppd. Dealers inquire Repro-Products, P.O. Box 71, Prairie View, IL 60069.

Bugged?



Know Who You're Dealing With

When you are contacted by a "friend of a friend" do you often worry about who you are really dealing with? We have a way for you to allay your fears and protect yourself in face to face conversations.

Our "bug" detection equipment, the Bug Alert EJ7, detects and alerts you to the existence of a bugging device concealed on someone in your presence or planted in the room.

This miniature unit is easily concealed in your pocket or hand. At the first sign of a bug it warns you, by a tiny 1/8" signal light, that your conversation is being transmitted to someone else or to a recording device outside the room.

For other debugging systems for room or telephone privacy call Ed Russell, (212) 682-4731.

Anti-Wiretapping & Anti-Bugging Corporation of America
605 Third Avenue
New York, N.Y. 10016
Attn: Mr. Ed Russell
Suite 940

Send \$20. for complete catalog and comprehensive report on how to protect yourself against room bugs and phone taps. Credited against first purchase.

Dealer Inquiries Invited

Name _____
Address _____
City _____
State _____ Zip _____
Telephone _____

SEEKING EMPLOYMENT as mercenary or similar job. Viet Nam vet, Recondo, Ranger, Jumpmaster, Sniper, LRRP Tactics, have passport, will travel. Contact Ken Gaudet, 3955 17th St., Apt. 22, San Francisco, CA 94113, or call 1-415-621-1863.

MILITARY BINOCULARS: Scarce Leitz 7x50 current Canadian military binoculars, individual focus, roof prisms, waterproof, extremely rugged, superior quality, new with case, \$840.00 postpaid. Trades accepted. CASANOVA'S, 1601 Greenfield, Milwaukee, WI 53204.

THREE RHODESIAN security force's recruiting brochures—BSAP, SAS, and Rhodesian Army. Only \$1.00 Phoenix Associates, Box 693, Boulder, CO 80302.

SOCIETY OF FRENCH INDOCHINA AND VIETNAM. Organized to bring together those interested in coins, medals, artifacts and history of Vietnam, from ancient times to the present. Don Valentine, P.O. Box 29965, Atlanta, GA 30329.

NEW MERC/SURVIVAL CATALOG! Available for the first time, from Phoenix Associates, is the new MERC/SURVIVAL CATALOG, Vol. #1. We're featuring a comprehensive list of U.S. and foreign "hard-to-find" military science books on guerrilla warfare, explosives/demolitions, self-defense, FMs, TMs, survival and weapons. PLUS top quality military/paramilitary and survival equipment for the professional adventurer. This catalog: MERC/SURVIVAL CATALOG, Vol. #1 is now available from Phoenix Associates. Send \$1.00 (refundable with first order) to: PHOENIX ASSOCIATES, P.O. Box 693, Dept. SF-2, Boulder, CO 80302. Please allow 30 days for delivery.

TYPESETTING: Books, brochures, manuscripts, etc. Reasonable rates. 20 years experience. Donna's Photocomposition, 647 Alpine, Longmont, CO 80501. Phone: (303) 772-6799.

WRITERS: "UNSALEABLE" MANUSCRIPT? Try AUTHOR AID ASSOCIATES, Dept. SOF, 340 East 52nd Street, N.Y.C. 10022. Plaza 8-4213.

NEW ILLUSTRATED CATALOG SHOWING OUR COMBAT RELICS, AND CLOTHING AND COMBAT LINE — \$2.00 POSTAGE PAID. WAR TWO SHOP, RD #1, BOX 154, MILFORD, DE 19963.

FOR SALE, Genuine United States Armed Forces Surplus clothing, individual equipment, packs, first aid packets, etc. Our catalog, 52¢ in stamps. Steve Pedergrana, Jr., 1036 S. Claremont, Chicago, IL 60612.

YOUR S&W 28 CONVERTED to .45 Colt, .44 Mag., .44 Spl., 40-40 41 Mag., 38-40. DAVID WOODRUFF, Box 5, Bear, DEL 19701.

SPIKED WRISTBANDS \$6.00 each, two for \$10.00. Spiked dog collars, small, medium, large, \$15.00. Also, rare Kung-Fu books and movies. Send for list. PARANOID PRODUCTIONS, POB 1115, Youngstown, OH 44501.

WANTED EMPLOYMENT as mercenary full time or job contract anywhere. I have two years' experience Viet Nam and three years' law enforcement experience. DWC, P.O. Box 695, Parma, OH 43060.

NEW! BIG BROTHER GAME—240 pages, 8 1/2 x 11" — FBI, CIA, OSS and KGB Techniques — Tailing — Surveillance — Surreptitious Entry — Detective Techniques — Weapons and Counter Measures — \$9.95 postpaid. Quimtronix, Box 548-S, Seattle, WA 98111.

CASH IN on Free government programs promoted with your Tax Dollars! Instruction manual: only \$3.95 postpaid. Rainier Books-SF2, Box 30753, Seattle, WA 98103.

CANNON AND HOBBY FUSE 3.32" diameter, waterproof. New, different, better. 15 feet, \$1.55 feet, \$3.95 feet, \$5. Postpaid. Other goodies. Catalog 25¢. Zeller Enterprises, Drawer W2X, Wickenburg, AZ 85358.

ADVENTURER looking for position as oil-well/gas-well fire fighter, courier, any other unusual position/assignment available. Self-defense trained, expert marksman, skilled in security, bodyguard, experienced investigator. Contact K. Robinson, 629 SE Franklin, Suite 7, Portland, OR 97202.

INTERNATIONAL INVESTIGATIONS: Personal, corporate, financial. Missing persons traced. Assignments undertaken. Debts recovered. Submit your requirements to: Dept. SP3, P.O. Box 693, Boulder, CO 80302.

"CUSTOM KNIVES," Large selection of fighting and boot knives, also hunting and folding knives. Catalog \$1.00. Crawford Knives, 205 N. Center, West Memphis, ARK 72301.

Thousands Sold
USA made 100% legal AMAZON
USE 30 DAYS AT OUR RISK
Lifetime weapon UNAVAILABLE ELSEWHERE
Don't be fooled by imitations!
New-Improved-50% More Powerful!

1/2 OFF
125 STEEL DARTS **BUY 2 GET 800 BONUS**
FREE DARTS **BUY 2 GET 800 BONUS**

GUARANTEED 15 YEARS
\$6.98

35 to a Asteroid
35 to a Asteroid

Thousands Sold
USA made 100% legal AMAZON
USE 30 DAYS AT OUR RISK
Lifetime weapon UNAVAILABLE ELSEWHERE
Don't be fooled by imitations!
New-Improved-50% More Powerful!

1/2 OFF
125 STEEL DARTS **BUY 2 GET 800 BONUS**
FREE DARTS **BUY 2 GET 800 BONUS**

GUARANTEED 15 YEARS
\$6.98

35 to a Asteroid
35 to a Asteroid

Thousands Sold
USA made 100% legal AMAZON
USE 30 DAYS AT OUR RISK
Lifetime weapon UNAVAILABLE ELSEWHERE
Don't be fooled by imitations!
New-Improved-50% More Powerful!

1/2 OFF
125 STEEL DARTS **BUY 2 GET 800 BONUS**
FREE DARTS **BUY 2 GET 800 BONUS**

GUARANTEED 15 YEARS
\$6.98

35 to a Asteroid
35 to a Asteroid

Thousands Sold
USA made 100% legal AMAZON
USE 30 DAYS AT OUR RISK
Lifetime weapon UNAVAILABLE ELSEWHERE
Don't be fooled by imitations!
New-Improved-50% More Powerful!

1/2 OFF
125 STEEL DARTS **BUY 2 GET 800 BONUS**
FREE DARTS **BUY 2 GET 800 BONUS**

GUARANTEED 15 YEARS
\$6.98

35 to a Asteroid
35 to a Asteroid

Thousands Sold
USA made 100% legal AMAZON
USE 30 DAYS AT OUR RISK
Lifetime weapon UNAVAILABLE ELSEWHERE
Don't be fooled by imitations!
New-Improved-50% More Powerful!

1/2 OFF
125 STEEL DARTS **BUY 2 GET 800 BONUS**
FREE DARTS **BUY 2 GET 800 BONUS**

GUARANTEED 15 YEARS
\$6.98

35 to a Asteroid
35 to a Asteroid

Thousands Sold
USA made 100% legal AMAZON
USE 30 DAYS AT OUR RISK
Lifetime weapon UNAVAILABLE ELSEWHERE
Don't be fooled by imitations!
New-Improved-50% More Powerful!

1/2 OFF
125 STEEL DARTS **BUY 2 GET 800 BONUS**
FREE DARTS **BUY 2 GET 800 BONUS**

GUARANTEED 15 YEARS
\$6.98

35 to a Asteroid
35 to a Asteroid

Thousands Sold
USA made 100% legal AMAZON
USE 30 DAYS AT OUR RISK
Lifetime weapon UNAVAILABLE ELSEWHERE
Don't be fooled by imitations!
New-Improved-50% More Powerful!

1/2 OFF
125 STEEL DARTS **BUY 2 GET 800 BONUS**
FREE DARTS **BUY 2 GET 800 BONUS**

GUARANTEED 15 YEARS
\$6.98

35 to a Asteroid
35 to a Asteroid

Thousands Sold
USA made 100% legal AMAZON
USE 30 DAYS AT OUR RISK
Lifetime weapon UNAVAILABLE ELSEWHERE
Don't be fooled by imitations!
New-Improved-50% More Powerful!

1/2 OFF
125 STEEL DARTS **BUY 2 GET 800 BONUS**
FREE DARTS **BUY 2 GET 800 BONUS**

GUARANTEED 15 YEARS
\$6.98

35 to a Asteroid
35 to a Asteroid

Thousands Sold
USA made 100% legal AMAZON
USE 30 DAYS AT OUR RISK
Lifetime weapon UNAVAILABLE ELSEWHERE
Don't be fooled by imitations!
New-Improved-50% More Powerful!

1/2 OFF
125 STEEL DARTS **BUY 2 GET 800 BONUS**
FREE DARTS **BUY 2 GET 800 BONUS**

GUARANTEED 15 YEARS
\$6.98

35 to a Asteroid
35 to a Asteroid

Thousands Sold
USA made 100% legal AMAZON
USE 30 DAYS AT OUR RISK
Lifetime weapon UNAVAILABLE ELSEWHERE
Don't be fooled by imitations!
New-Improved-50% More Powerful!

1/2 OFF
125 STEEL DARTS **BUY 2 GET 800 BONUS**
FREE DARTS **BUY 2 GET 800 BONUS**

GUARANTEED 15 YEARS
\$6.98

35 to a Asteroid
35 to a Asteroid

Thousands Sold
USA made 100% legal AMAZON
USE 30 DAYS AT OUR RISK
Lifetime weapon UNAVAILABLE ELSEWHERE
Don't be fooled by imitations!
New-Improved-50% More Powerful!

1/2 OFF
125 STEEL DARTS **BUY 2 GET 800 BONUS**
FREE DARTS **BUY 2 GET 800 BONUS**

GUARANTEED 15 YEARS
\$6.98

35 to a Asteroid
35 to a Asteroid

Thousands Sold
USA made 100% legal AMAZON
USE 30 DAYS AT OUR RISK
Lifetime weapon UNAVAILABLE ELSEWHERE
Don't be fooled by imitations!
New-Improved-50% More Powerful!

1/2 OFF
125 STEEL DARTS **BUY 2 GET 800 BONUS**
FREE DARTS **BUY 2 GET 800 BONUS**

GUARANTEED 15 YEARS
\$6.98

35 to a Asteroid
35 to a Asteroid

Thousands Sold
USA made 100% legal AMAZON
USE 30 DAYS AT OUR RISK
Lifetime weapon UNAVAILABLE ELSEWHERE
Don't be fooled by imitations!
New-Improved-50% More Powerful!

1/2 OFF
125 STEEL DARTS **BUY 2 GET 800 BONUS**
FREE DARTS **BUY 2 GET 800 BONUS**

GUARANTEED 15 YEARS
\$6.98

35 to a Asteroid
35 to a Asteroid

Thousands Sold
USA made 100% legal AMAZON
USE 30 DAYS AT OUR RISK
Lifetime weapon UNAVAILABLE ELSEWHERE
Don't be fooled by imitations!
New-Improved-50% More Powerful!

1/2 OFF
125 STEEL DARTS **BUY 2 GET 800 BONUS**
FREE DARTS **BUY 2 GET 800 BONUS**

GUARANTEED 15 YEARS
\$6.98

35 to a Asteroid
35 to a Asteroid

Thousands Sold
USA made 100% legal AMAZON
USE 30 DAYS AT OUR RISK
Lifetime weapon UNAVAILABLE ELSEWHERE
Don't be fooled by imitations!
New-Improved-50% More Powerful!

1/2 OFF
125 STEEL DARTS **BUY 2 GET 800 BONUS**
FREE DARTS **BUY 2 GET 800 BONUS**

GUARANTEED 15 YEARS
\$6.98

35 to a Asteroid
35 to a Asteroid

Thousands Sold
USA made 100% legal AMAZON
USE 30 DAYS AT OUR RISK
Lifetime weapon UNAVAILABLE ELSEWHERE
Don't be fooled by imitations!
New-Improved-50% More Powerful!

1/2 OFF
125 STEEL DARTS **BUY 2 GET 800 BONUS**
FREE DARTS **BUY 2 GET 800 BONUS**

GUARANTEED 15 YEARS
\$6.98

35 to a Asteroid
35 to a Asteroid

Thousands Sold
USA made 100% legal AMAZON
USE 30 DAYS AT OUR RISK
Lifetime weapon UNAVAILABLE ELSEWHERE
Don't be fooled by imitations!
New-Improved-50% More Powerful!

1/2 OFF
125 STEEL DARTS **BUY 2 GET 800 BONUS**
FREE DARTS **BUY 2 GET 800 BONUS**

GUARANTEED 15 YEARS
\$6.98

35 to a Asteroid
35 to a Asteroid

Thousands Sold
USA made 100% legal AMAZON
USE 30 DAYS AT OUR RISK
Lifetime weapon UNAVAILABLE ELSEWHERE
Don't be fooled by imitations!
New-Improved-50% More Powerful!

1/2 OFF
125 STEEL DARTS **BUY 2 GET 800 BONUS**
FREE DARTS **BUY 2 GET 800 BONUS**

GUARANTEED 15 YEARS
\$6.98

35 to a Asteroid
35 to a Asteroid

Thousands Sold
USA made 100% legal AMAZON
USE 30 DAYS AT OUR RISK
Lifetime weapon UNAVAILABLE ELSEWHERE
Don't be fooled by imitations!
New-Improved-50% More Powerful!

1/2 OFF
125 STEEL DARTS **BUY 2 GET 800 BONUS**
FREE DARTS **BUY 2 GET 800 BONUS**

GUARANTEED 15 YEARS
\$6.98

35 to a Asteroid
35 to a Asteroid

Thousands Sold
USA made 100% legal AMAZON
USE 30 DAYS AT OUR RISK
Lifetime weapon UNAVAILABLE ELSEWHERE
Don't be fooled by imitations!
New-Improved-50% More Powerful!

1/2 OFF
125 STEEL DARTS **BUY 2 GET 800 BONUS**
FREE DARTS **BUY 2 GET 800 BONUS**

GUARANTEED 15 YEARS
\$6.98

35 to a Asteroid
35 to a Asteroid

Thousands Sold
USA made 100% legal AMAZON
USE 30 DAYS AT OUR RISK
Lifetime weapon UNAVAILABLE ELSEWHERE
Don't be fooled by imitations!
New-Improved-50% More Powerful!

1/2 OFF
125 STEEL DARTS **BUY 2 GET 800 BONUS**
FREE DARTS **BUY 2 GET 800 BONUS**

GUARANTEED 15 YEARS
\$6.98

35 to a Asteroid
35 to a Asteroid

Thousands Sold
USA made 100% legal AMAZON
USE 30 DAYS AT OUR RISK
Lifetime weapon UNAVAILABLE ELSEWHERE
Don't be fooled by imitations!
New-Improved-50% More Powerful!

1/2 OFF
125 STEEL DARTS **BUY 2 GET 800 BONUS**
FREE DARTS **BUY 2 GET 800 BONUS**

GUARANTEED 15 YEARS
\$6.98

35 to a Asteroid
35 to a Asteroid

Thousands Sold
USA made 100% legal AMAZON
USE 30 DAYS AT OUR RISK
Lifetime weapon UNAVAILABLE ELSEWHERE
Don't be fooled by imitations!
New-Improved-50% More Powerful!

1/2 OFF
125 STEEL DARTS **BUY 2 GET 800 BONUS**
FREE DARTS **BUY 2 GET 800 BONUS**

GUARANTEED 15 YEARS
\$6.98

35 to a Asteroid
35 to a Asteroid

Thousands Sold
USA made 100% legal AMAZON
USE 30 DAYS AT OUR RISK
Lifetime weapon UNAVAILABLE ELSEWHERE
Don't be fooled by imitations!
New-Improved-50% More Powerful!

1/2 OFF
125 STEEL DARTS **BUY 2 GET 800 BONUS**
FREE DARTS **BUY 2 GET 800 BONUS**

GUARANTEED 15 YEARS
\$6.98

35 to a Asteroid
35 to a Asteroid

Thousands Sold
USA made 100% legal AMAZON
USE 30 DAYS AT OUR RISK
Lifetime weapon UNAVAILABLE ELSEWHERE
Don't be fooled by imitations!
New-Improved-50% More Powerful!

1/2 OFF
125 STEEL DARTS **BUY 2 GET 800 BONUS**
FREE DARTS **BUY 2 GET 800 BONUS**

GUARANTEED 15 YEARS
\$6.98

35 to a Asteroid
35 to a Asteroid

Thousands Sold
USA made 100% legal AMAZON
USE 30 DAYS AT OUR RISK
Lifetime weapon UNAVAILABLE ELSEWHERE
Don't be fooled by imitations!
New-Improved-50% More Powerful!

1/2 OFF
125 STEEL DARTS **BUY 2 GET 800 BONUS**
FREE DARTS **BUY 2 GET 800 BONUS**

GUARANTEED 15 YEARS
\$6.98

35 to a Asteroid
35 to a Asteroid

Thousands Sold
USA made 100% legal AMAZON
USE 30 DAYS AT OUR RISK
Lifetime weapon UNAVAILABLE ELSEWHERE
Don't be fooled by imitations!
New-Improved-50% More Powerful!

1/2 OFF
125 STEEL DARTS **BUY 2 GET 800 BONUS**
FREE DARTS **BUY 2 GET 800 BONUS**

GUARANTEED 15 YEARS
\$6.98

35 to a Asteroid
35 to a Asteroid

Thousands Sold
USA made 100% legal AMAZON
USE 30 DAYS AT OUR RISK
Lifetime weapon UNAVAILABLE ELSEWHERE
Don't be fooled by imitations!
New-Improved-50% More Powerful!

1/2 OFF
125 STEEL DARTS **BUY 2 GET 800 BONUS**
FREE DARTS **BUY 2 GET 800 BONUS**

GUARANTEED 15 YEARS
\$6.98

35 to a Asteroid
35 to a Asteroid

Thousands Sold
USA made 100% legal AMAZON
USE 30 DAYS AT OUR RISK
Lifetime weapon UNAVAILABLE ELSEWHERE
Don't be fooled by imitations!
New-Improved-50% More Powerful!

1/2 OFF
125 STEEL DARTS **BUY 2 GET 800 BONUS**
FREE DARTS **BUY 2 GET 800 BONUS**

GUARANTEED 15 YEARS
\$6.98

35 to a Asteroid
35 to a Asteroid

Thousands Sold
USA made 100% legal AMAZON
USE 30 DAYS AT OUR RISK
Lifetime weapon UNAVAILABLE ELSEWHERE
Don't be fooled by imitations!
New-Improved-50% More Powerful!

1/2 OFF
125 STEEL DARTS **BUY 2 GET 800 BONUS**
FREE DARTS **BUY 2 GET 800 BONUS**

GUARANTEED 15 YEARS
\$6.98

35 to a Asteroid
35 to a Asteroid

Thousands Sold
USA made 100% legal AMAZON
USE 30 DAYS AT OUR RISK
Lifetime weapon UNAVAILABLE ELSEWHERE
Don't be fooled by imitations!
New-Improved-50% More Powerful!

1/2 OFF
125 STEEL DARTS **BUY 2 GET 800 BONUS**
FREE DARTS **BUY 2 GET 800 BONUS**

GUARANTEED 15 YEARS
\$6.98

35 to a Asteroid
35 to a Asteroid

Thousands Sold
USA made 100% legal AMAZON
USE 30 DAYS AT OUR RISK
Lifetime weapon UNAVAILABLE ELSEWHERE
Don't be fooled by imitations!
New-Improved-50% More Powerful!

1/2 OFF
125 STEEL DARTS **BUY 2 GET 800 BONUS**
FREE DARTS **BUY 2 GET 800 BONUS**

GUARANTEED 15 YEARS
\$6.98

35 to a Asteroid
35 to a Asteroid

Thousands Sold
USA made 100% legal AMAZON
USE 30 DAYS AT OUR RISK
Lifetime weapon UNAVAILABLE ELSEWHERE
Don't be fooled by imitations!
New-Improved-50% More Powerful!

1/2 OFF
125 STEEL DARTS **BUY 2 GET 800 BONUS**
FREE DARTS **BUY 2 GET 800 BONUS**

GUARANTEED 15 YEARS
\$6.98

35 to a Asteroid
35 to a Asteroid

Thousands Sold
USA made 100% legal AMAZON
USE 30 DAYS AT OUR RISK
Lifetime weapon UNAVAILABLE ELSEWHERE
Don't be fooled by imitations!
New-Improved-50% More Powerful!

1/2 OFF
125 STEEL DARTS **BUY 2 GET 800 BONUS**
FREE DARTS **BUY 2 GET 800 BONUS**

GUARANTEED 15 YEARS
\$6.98

35 to a Asteroid
35 to a Asteroid

Thousands Sold
USA made 100% legal AMAZON
USE 30 DAYS AT OUR RISK
Lifetime weapon UNAVAILABLE ELSEWHERE
Don't be fooled by imitations!
New-Improved-50% More Powerful!

1/2 OFF
125 STEEL DARTS **BUY 2 GET 800 BONUS**
FREE DARTS **BUY 2 GET 800 BONUS**

GUARANTEED 15 YEARS
\$6.98

35 to a Asteroid
35 to a Asteroid

Thousands Sold
USA made 100% legal AMAZON
USE 30 DAYS AT OUR RISK
Lifetime weapon UNAVAILABLE ELSEWHERE
Don't be fooled by imitations!
New-Improved-50% More Powerful!

1/2 OFF
125 STEEL DARTS **BUY 2 GET 800 BONUS**
FREE DARTS **BUY 2 GET 800 BONUS**

GUARANTEED 15 YEARS
\$6.98

35 to a Asteroid
35 to a Asteroid

Thousands Sold
USA made 100% legal AMAZON
USE 30 DAYS AT OUR RISK
Lifetime weapon UNAVAILABLE ELSEWHERE
Don't be fooled by imitations!
New-Improved-50% More Powerful!

1/2 OFF
125 STEEL DARTS **BUY 2 GET 800 BONUS**
FREE DARTS **BUY 2 GET 800 BONUS**

GUARANTEED 15 YEARS
\$6.98

35 to a Asteroid
35 to a Asteroid

Thousands Sold
USA made 100% legal AMAZON
USE 30 DAYS AT OUR RISK
Lifetime weapon UNAVAILABLE ELSEWHERE
Don't be fooled by imitations!
New-Improved-50% More Powerful!

1/2 OFF
125 STEEL DARTS **BUY 2 GET 800 BONUS**
FREE DARTS **BUY 2 GET 800 BONUS**

GUARANTEED 15 YEARS
\$6.98

35 to a Asteroid
35 to a Asteroid

Thousands Sold
USA made 100% legal AMAZON
USE 30 DAYS AT OUR RISK
Lifetime weapon UNAVAILABLE ELSEWHERE
Don't be fooled by imitations!
New-Improved-50% More Powerful!

1/2 OFF
125 STEEL DARTS **BUY 2 GET 800 BONUS**
FREE DARTS **BUY 2 GET 800 BONUS**

GUARANTEED 15 YEARS
\$6.98

35 to a Asteroid
35 to a Asteroid

Thousands Sold
USA made 100% legal AMAZON
USE 30 DAYS AT OUR RISK
Lifetime weapon UNAVAILABLE ELSEWHERE
Don't be fooled by imitations!
New-Improved-50% More Powerful!

1/2 OFF
125 STEEL DARTS **BUY 2 GET 800 BONUS**
FREE DARTS **BUY 2 GET 800 BONUS**

GUARANTEED 15 YEARS
\$6.98

35 to a Asteroid
35 to a Asteroid

Thousands Sold
USA made 100% legal AMAZON
USE 30 DAYS AT OUR RISK
Lifetime weapon UNAVAILABLE ELSEWHERE
Don't be fooled by imitations!
New-Improved-50% More Powerful!

1/2 OFF
125 STEEL DARTS **BUY 2 GET 800 BONUS**
FREE DARTS **BUY 2 GET 800 BONUS**

GUARANTEED 15 YEARS
\$6.98

35 to a Asteroid
35 to a Asteroid

Thousands Sold
USA made 100% legal AMAZON
USE 30 DAYS AT OUR RISK
Lifetime weapon UNAVAILABLE ELSEWHERE
Don't be fooled by imitations!
New-Improved-50% More Powerful!

1/2 OFF
125 STEEL DARTS **BUY 2 GET 800 BONUS**
FREE DARTS **BUY 2 GET 800 BONUS**

GUARANTEED 15 YEARS
\$6.98

35 to a Asteroid
35 to a Asteroid

Thousands Sold
USA made 100% legal AMAZON
USE 30 DAYS AT OUR RISK
Lifetime weapon UNAVAILABLE ELSEWHERE
Don't be fooled by imitations!
New-Improved-50% More Powerful!

1/2 OFF
125 STEEL DARTS **BUY 2 GET 800 BONUS**
FREE DARTS **BUY 2 GET 800 BONUS**

GUARANTEED 15 YEARS
\$6.98

35 to a Asteroid
35 to a Asteroid

Thousands Sold
USA made 100% legal AMAZON
USE 30 DAYS AT OUR RISK
Lifetime weapon UNAVAILABLE ELSEWHERE
Don't be fooled by imitations!
New-Improved-50% More Powerful!

1/2 OFF
125 STEEL DARTS **BUY 2 GET 800 BONUS**
FREE DARTS **BUY 2 GET 800 BONUS**

GUARANTEED 15 YEARS
\$6.98

35 to a Asteroid
35 to a Asteroid

Thousands Sold
USA made 100% legal AMAZON
USE 30 DAYS AT OUR RISK
Lifetime weapon UNAVAILABLE ELSEWHERE
Don't be fooled by imitations!
New-Improved-50% More Powerful!

1/2 OFF
125 STEEL DARTS **BUY 2 GET 800 BONUS**
FREE DARTS **BUY 2 GET 800 BONUS**

GUARANTEED 15 YEARS
\$6.98

35 to a Asteroid
35 to a Asteroid

Thousands Sold
USA made 100% legal AMAZON
USE 30 DAYS AT OUR RISK
Lifetime weapon UNAVAILABLE ELSEWHERE
Don't be fooled by imitations!
New-Improved-50% More Powerful!

1/2 OFF
125 STEEL DARTS **BUY 2 GET 800 BONUS**
FREE DARTS **BUY 2 GET 800 BONUS**

GUARANTEED 15 YEARS
\$6.98

35 to a Asteroid
35 to a Asteroid

Thousands Sold
USA made 100% legal AMAZON
USE 30 DAYS AT OUR RISK
Lifetime weapon UNAVAILABLE ELSEWHERE
Don't be fooled by imitations!
New-Improved-50% More Powerful!

1/2 OFF
125 STEEL DARTS **BUY 2 GET 800 BONUS**
FREE DARTS **BUY 2 GET 800 BONUS**

GUARANTEED 15 YEARS
\$6.98

35 to a Asteroid
35 to a Asteroid

Thousands Sold
USA made 100% legal AMAZON
USE 30 DAYS AT OUR RISK
Lifetime weapon UNAVAILABLE ELSEWHERE
Don't be fooled by imitations!
New-Improved-50% More Powerful!

1/2 OFF
125 STEEL DARTS **BUY 2 GET 800 BONUS**
FREE DARTS **BUY 2 GET 800 BONUS**

GUARANTEED 15 YEARS
\$6.98

35 to a Asteroid
35 to a Asteroid

Thousands Sold
USA made 100% legal AMAZON
USE 30 DAYS AT OUR RISK
Lifetime weapon UNAVAILABLE ELSEWHERE
Don't be fooled by imitations!
New-Improved-50% More Powerful!

1/2 OFF
125 STEEL DARTS **BUY 2 GET 800 BONUS**
FREE DARTS **BUY 2 GET 800 BONUS**

GUARANTEED 15 YEARS
\$6.98

35 to a Asteroid
35 to a Asteroid

Thousands Sold
USA made 100% legal AMAZON
USE 30 DAYS AT OUR RISK
Lifetime weapon UNAVAILABLE ELSEWHERE
Don't be fooled by imitations!
New-Improved-50% More Powerful!

1/2 OFF
125 STEEL DARTS **BUY 2 GET 800 BONUS**
FREE DARTS **BUY 2 GET 800 BONUS**

GUARANTEED 15 YEARS
\$6.98

35 to a Asteroid
35 to a Asteroid

Thousands Sold
USA made 100% legal AMAZON
USE 30 DAYS AT OUR RISK
Lifetime weapon UNAVAILABLE ELSEWHERE
Don't be fooled by imitations!
New-Improved-50% More Powerful!

1/2 OFF
125 STEEL DARTS **BUY 2 GET 800 BONUS**
FREE DARTS **BUY 2 GET 800 BONUS**

GUARANTEED 15 YEARS
\$6

NORDAC

THE LATEST U.S. MILITARY ITEMS OF INDIVIDUAL EQUIPMENT AND ACCESSORIES

PROVIDING: MILITARY FIELD EQUIPMENT AT THE LOWEST COST AND THE HIGHEST STANDARDS, WITH GUARANTEED PERFORMANCE AND U.S. MILITARY SPECIFICATIONS.



PARTIAL PRODUCT CAPABILITY LIST:

BAG, DUFFEL	HOLSTERS
BAYONETS	KNAPSACKS
BELT, INDIVIDUAL EQUIPMENT	KNIVES
BELT, MILITARY POLICE	MACHETES
BIPOD	MAINTENANCE EQUIPMENT
BIPOD, CASE	MAGAZINES
BOOTS	MAGAZINES, POUCHES
CANTEEN	PISTOL BELTS
CANTEEN, COVER	PONCHO
CANTEEN, CUP	POUCHES
CARRIERS	RIFLE SLINGS
CASE, SMALL ARMS	SLINGS, ASSAULT
CLOTHING, COMBAT	SPARE PARTS, ORDINANCE
FIELD PACKS	SUSPENDERS
FIELD PACK, FRAME	UNDERWARE
GAS MASKS	UNIFORMS
HANDCUFFS	VEST, ARMOR



NORDAC

A DIVISION OF THE NORDAC GROUP

DEPT S

LOCUST GROVE, VIRGINIA 22508, U.S.A.

TELEPHONE: (703) 659-2123

TELEX: 89-7440



WEAR A LEGEND

The paratroopers of the U.S. Army Airborne are known for their dauntless courage and camaraderie. This ring is an authentic casting of the official paratrooper wings insignia. To wear it is to participate in everything the legend signifies: Taking risks. Going beyond the limits. Living on the edge. Your choice of solid sterling silver or 14 karat solid gold, antiqued or with inlaid semi-precious stones. Order yours now.

THE U.S. PARATROOPER RING

Please rush me my paratrooper ring(s)

Solid Sterling Silver

- Plain \$29.95
- Antiqued \$39.95 (shown above)

With inlaid stones:

- Turquoise \$49.95
- Lapis \$49.95
- Red Coral \$49.95

Guarantee: If you're not satisfied, return the ring to us within 10 days for full refund.

Dealer and distributor inquiries welcome.

14K Solid Gold

- Plain \$129.95

With inlaid stones:

- Turquoise \$149.95
- Lapis \$149.95
- Red Coral \$149.95



Enclosed is my check or money order for \$ _____

Charge to: Master Charge BankAmericard Visa
Card No. _____

Expiration Date _____

My Name _____

Address _____

City _____ State _____ Zip _____

Add \$1 for postage and handling. In Calif. add 6% sales tax.

Send me a color poster (17" x 22") of this picture. \$3.50.
Ring size (if not known use finger calibrator below) _____

Signature _____

Mail coupon to:
THE AIRBORNE COMPANY
8722 Airlane Avenue, Los Angeles, CA 90045

Cut out. Wrap around thickest part of finger (usually knuckle).

Measure to this line.

0 1 2 3 4 5 6 7 8 9 10 11 12 13 14 15